

Chapter 1: MEASUREMENT

- The SI standard of time is based on:
 - the daily rotation of the earth
 - the frequency of light emitted by Kr^{86}
 - the yearly revolution of the earth about the sun
 - a precision pendulum clock
 - none of theseAns: E
- A nanosecond is:
 - 10^9 s
 - 10^{-9} s
 - 10^{-10} s
 - 10^{-10} s
 - 10^{-12}Ans: B
- The SI standard of length is based on:
 - the distance from the north pole to the equator along a meridian passing through Paris
 - wavelength of light emitted by Hg^{198}
 - wavelength of light emitted by Kr^{86}
 - a precision meter stick in Paris
 - the speed of lightAns: E
- In 1866, the U. S. Congress defined the U. S. yard as exactly 3600/3937 international meter. This was done primarily because:
 - length can be measured more accurately in meters than in yards
 - the meter is more stable than the yard
 - this definition relates the common U. S. length units to a more widely used system
 - there are more wavelengths in a yard than in a meter
 - the members of this Congress were exceptionally intelligentAns: C
- Which of the following is closest to a yard in length?
 - 0.01 m
 - 0.1 m
 - 1 m
 - 100 m
 - 1000 mAns: C

6. There is no SI base unit for area because:
- A. an area has no thickness; hence no physical standard can be built
 - B. we live in a three (not a two) dimensional world
 - C. it is impossible to express square feet in terms of meters
 - D. area can be expressed in terms of square meters
 - E. area is not an important physical quantity

Ans: D

7. The SI base unit for mass is:

- A. gram
- B. pound
- C. kilogram
- D. ounce
- E. kilopound

Ans: C

8. A gram is:

- A. 10^{-6} kg
- B. 10^{-3} kg
- C. 1 kg
- D. 10^3 kg
- E. 10^6 kg

Ans: B

9. Which of the following weighs about a pound?

- A. 0.05 kg
- B. 0.5 kg
- C. 5 kg
- D. 50 kg
- E. 500 kg

Ans: D

10. $(5.0 \times 10^4) \times (3.0 \times 10^6) =$

- A. 1.5×10^9
- B. 1.5×10^{10}
- C. 1.5×10^{11}
- D. 1.5×10^{12}
- E. 1.5×10^{13}

Ans: C

11. $(5.0 \times 10^4) \times (3.0 \times 10^{-6}) =$

- A. 1.5×10^{-3}
- B. 1.5×10^{-1}
- C. 1.5×10^1
- D. 1.5×10^3
- E. 1.5×10^5

Ans: B

12. $5.0 \times 10^5 + 3.0 \times 10^6 =$

- A. 8.0×10^5
- B. 8.0×10^6
- C. 5.3×10^5
- D. 3.5×10^5
- E. 3.5×10^6

Ans: E

13. $(7.0 \times 10^6)/(2.0 \times 10^{-6}) =$

- A. 3.5×10^{-12}
- B. 3.5×10^{-6}
- C. 3.5
- D. 3.5×10^6
- E. 3.5×10^{12}

Ans: E

14. The number of significant figures in 0.00150 is:

- A. 2
- B. 3
- C. 4
- D. 5
- E. 6

Ans: B

15. The number of significant figures in 15.0 is:

- A. 1
- B. 2
- C. 3
- D. 4
- E. 5

Ans: C

16. $3.2 \times 2.7 =$

- A. 9
- B. 8
- C. 8.6
- D. 8.64
- E. 8.640

Ans: C

17. $1.513 + 27.3 =$

- A. 29
- B. 28.8
- C. 28.9
- D. 28.81
- E. 28.813

()Ans: B

18. 1 mi is equivalent to 1609 m so 55 mph is:

- A. 15 m/s
- B. 25 m/s
- C. 66 m/s
- D. 88 m/s
- E. 1500 m/s

Ans: B

19. A sphere with a radius of 1.7 cm has a volume of:

- A. $2.1 \times 10^{-5} \text{ m}^3$
- B. $9.1 \times 10^{-4} \text{ m}^3$
- C. $3.6 \times 10^{-3} \text{ m}^3$
- D. 0.11 m^3
- E. 21 m^3

Ans: A

20. A sphere with a radius of 1.7 cm has a surface area of:

- A. $2.1 \times 10^{-5} \text{ m}^2$
- B. $9.1 \times 10^{-4} \text{ m}^2$
- C. $3.6 \times 10^{-3} \text{ m}^2$
- D. 0.11 m^2
- E. 36 m^2

Ans: C

21. A right circular cylinder with a radius of 2.3 cm and a height of 1.4 m has a volume of:

- A. 0.20 m^3
- B. 0.14 m^3
- C. $9.3 \times 10^{-3} \text{ m}^3$
- D. $2.3 \times 10^{-3} \text{ m}^3$
- E. $7.4 \times 10^{-4} \text{ m}^3$

Ans: D

22. A right circular cylinder with a radius of 2.3 cm and a height of 1.4 cm has a total surface area of:

- A. $1.7 \times 10^{-3} \text{ m}^2$
- B. $3.2 \times 10^{-3} \text{ m}^2$
- C. $2.0 \times 10^{-3} \text{ m}^3$
- D. $5.3 \times 10^{-3} \text{ m}^2$
- E. $7.4 \times 10^{-3} \text{ m}^2$

Ans: D

23. A cubic box with an edge of exactly 1 cm has a volume of:

- A. 10^{-9} m^3
- B. 10^{-6} m^3
- C. 10^{-3} m^3
- D. 10^3 m^3
- E. 10^6 m^3

Ans: B

24. A square with an edge of exactly 1 cm has an area of:

- A. 10^{-6} m^2
- B. 10^{-4} m^2
- C. 10^2 m^2
- D. 10^4 m^2
- E. 10^6 m^2

Ans: B

25. 1 m is equivalent to 3.281 ft. A cube with an edge of 1.5 ft has a volume of:

- A. $1.2 \times 10^2 \text{ m}^3$
- B. $9.6 \times 10^{-2} \text{ m}^3$
- C. 10.5 m^3
- D. $9.5 \times 10^{-2} \text{ m}^3$
- E. 0.21 m^3

Ans: B

26. During a short interval of time the speed v in m/s of an automobile is given by $v = at^2 + bt^3$, where the time t is in seconds. The units of a and b are respectively:

- A. $\text{m} \cdot \text{s}^2$; $\text{m} \cdot \text{s}^4$
- B. s^3/m ; s^4/m
- C. m/s^2 ; m/s^3
- D. m/s^3 ; m/s^4
- E. m/s^4 ; m/s^5

Ans: D

27. Suppose $A = BC$, where A has the dimension L/M and C has the dimension L/T. Then B has the dimension:

- A. T/M
- B. L^2/TM
- C. TM/L^2
- D. $\text{L}^2\text{T}/\text{M}$
- E. $\text{M}/\text{L}^2\text{T}$

Ans: A

28. Suppose $A = B^n C^m$, where A has dimensions LT , B has dimensions L^2T^{-1} , and C has dimensions LT^2 . Then the exponents n and m have the values:

- A. $2/3; 1/3$
- B. $2; 3$
- C. $4/5; -1/5$
- D. $1/5; 3/5$
- E. $1/2; 1/2$

Ans: D

www.allonlinefree.com

Chapter 2: MOTION ALONG A STRAIGHT LINE

- A particle moves along the x axis from x_i to x_f . Of the following values of the initial and final coordinates, which results in the displacement with the largest magnitude?
 - $x_i = 4 \text{ m}, x_f = 6 \text{ m}$
 - $x_i = -4 \text{ m}, x_f = -8 \text{ m}$
 - $x_i = -4 \text{ m}, x_f = 2 \text{ m}$
 - $x_i = 4 \text{ m}, x_f = -2 \text{ m}$
 - $x_i = -4 \text{ m}, x_f = 4 \text{ m}$ans: E
- A particle moves along the x axis from x_i to x_f . Of the following values of the initial and final coordinates, which results in a negative displacement?
 - $x_i = 4 \text{ m}, x_f = 6 \text{ m}$
 - $x_i = -4 \text{ m}, x_f = -8 \text{ m}$
 - $x_i = -4 \text{ m}, x_f = 2 \text{ m}$
 - $x_i = -4 \text{ m}, x_f = -2 \text{ m}$
 - $x_i = -4 \text{ m}, x_f = 4 \text{ m}$ans: B
- The average speed of a moving object during a given interval of time is always:
 - the magnitude of its average velocity over the interval
 - the distance covered during the time interval divided by the time interval
 - one-half its speed at the end of the interval
 - its acceleration multiplied by the time interval
 - one-half its acceleration multiplied by the time interval.ans: B
- Two automobiles are 150 kilometers apart and traveling toward each other. One automobile is moving at 60 km/h and the other is moving at 40 km/h mph. In how many hours will they meet?
 - 2.5
 - 2.0
 - 1.75
 - 1.5
 - 1.25ans: D
- A car travels 40 kilometers at an average speed of 80 km/h and then travels 40 kilometers at an average speed of 40 km/h. The average speed of the car for this 80-km trip is:
 - 40 km/h
 - 45 km/h
 - 48 km/h
 - 53 km/h
 - 80 km/hans: D

6. A car starts from Hither, goes 50 km in a straight line to Yon, immediately turns around, and returns to Hither. The time for this round trip is 2 hours. The magnitude of the average velocity of the car for this round trip is:
- A. 0
 - B. 50 km/hr
 - C. 100 km/hr
 - D. 200 km/hr
 - E. cannot be calculated without knowing the acceleration
- ans: A

7. A car starts from Hither, goes 50 km in a straight line to Yon, immediately turns around, and returns to Hither. The time for this round trip is 2 hours. The average speed of the car for this round trip is:
- A. 0
 - B. 50 km/h
 - C. 100 km/h
 - D. 200 km/h
 - E. cannot be calculated without knowing the acceleration
- ans: B

8. The coordinate of a particle in meters is given by $x(t) = 16t - 3.0t^3$, where the time t is in seconds. The particle is momentarily at rest at $t =$
- A. 0.75 s
 - B. 1.3 s
 - C. 5.3 s
 - D. 7.3 s
 - E. 9.3 s
- ans: B

9. A drag racing car starts from rest at $t = 0$ and moves along a straight line with velocity given by $v = bt^2$, where b is a constant. The expression for the distance traveled by this car from its position at $t = 0$ is:
- A. bt^3
 - B. $bt^3/3$
 - C. $4bt^2$
 - D. $3bt^2$
 - E. $bt^{3/2}$
- ans: B

10. A ball rolls up a slope. At the end of three seconds its velocity is 20 cm/s; at the end of eight seconds its velocity is 0. What is the average acceleration from the third to the eighth second?
- A. 2.5 cm/s^2
 - B. 4.0 cm/s^2
 - C. 5.0 cm/s^2
 - D. 6.0 cm/s^2
 - E. 6.67 cm/s^2
- ans: B

11. The coordinate of an object is given as a function of time by $x = 7t - 3t^2$, where x is in meters and t is in seconds. Its average velocity over the interval from $t = 0$ to $t = 4$ s is:
- A. 5 m/s
 - B. -5 m/s
 - C. 11 m/s
 - D. -11 m/s
 - E. -14.5 m/s
- ans: B

12. The velocity of an object is given as a function of time by $v = 4t - 3t^2$, where v is in m/s and t is in seconds. Its average velocity over the interval from $t = 0$ to $t = 2$ s:
- A. is 0
 - B. is -2 m/s
 - C. is 2 m/s
 - D. is -4 m/s
 - E. cannot be calculated unless the initial position is given
- ans: A

13. The coordinate of an object is given as a function of time by $x = 4t^2 - 3t^3$, where x is in meters and t is in seconds. Its average acceleration over the interval from $t = 0$ to $t = 2$ s is:
- A. -4 m/s^2
 - B. 4 m/s^2
 - C. -10 m/s^2
 - D. 10 m/s^2
 - E. -13 m/s^2
- ans: C

14. Each of four particles move along an x axis. Their coordinates (in meters) as functions of time (in seconds) are given by
- particle 1: $x(t) = 3.5 - 2.7t^3$
 - particle 2: $x(t) = 3.5 + 2.7t^3$
 - particle 3: $x(t) = 3.5 + 2.7t^2$
 - particle 4: $x(t) = 3.5 - 3.4t - 2.7t^2$
- Which of these particles have constant acceleration?
- A. All four
 - B. Only 1 and 2
 - C. Only 2 and 3
 - D. Only 3 and 4
 - E. None of them
- ans: D

15. Each of four particles move along an x axis. Their coordinates (in meters) as functions of time (in seconds) are given by

particle 1: $x(t) = 3.5 - 2.7t^3$

particle 2: $x(t) = 3.5 + 2.7t^3$

particle 3: $x(t) = 3.5 + 2.7t^2$

particle 4: $x(t) = 3.5 - 3.4t - 2.7t^2$

Which of these particles is speeding up for $t > 0$?

- A. All four
- B. Only 1
- C. Only 2 and 3
- D. Only 2, 3, and 4
- E. None of them

ans: A

16. An object starts from rest at the origin and moves along the x axis with a constant acceleration of 4 m/s^2 . Its average velocity as it goes from $x = 2 \text{ m}$ to $x = 8 \text{ m}$ is:

- A. 1 m/s
- B. 2 m/s
- C. 3 m/s
- D. 5 m/s
- E. 6 m/s

ans: E

17. Of the following situations, which one is impossible?

- A. A body having velocity east and acceleration east
- B. A body having velocity east and acceleration west
- C. A body having zero velocity and non-zero acceleration
- D. A body having constant acceleration and variable velocity
- E. A body having constant velocity and variable acceleration

ans: E

18. Throughout a time interval, while the speed of a particle increases as it moves along the x axis, its velocity and acceleration might be:

- A. positive and negative, respectively
- B. negative and positive, respectively
- C. negative and negative, respectively
- D. negative and zero, respectively
- E. positive and zero, respectively

ans: C

19. A particle moves on the x axis. When its acceleration is positive and increasing:

- A. its velocity must be positive
- B. its velocity must be negative
- C. it must be slowing down
- D. it must be speeding up
- E. none of the above must be true

ans: E

20. The position y of a particle moving along the y axis depends on the time t according to the equation $y = at - bt^2$. The dimensions of the quantities a and b are respectively:
- A. $L^2/T, L^3/T^2$
 - B. $L/T^2, L^2/T$
 - C. $L/T, L/T^2$
 - D. $L^3/T, T^2/L$
 - E. none of these
- ans: C
21. A particle moves along the x axis according to the equation $x = 6t^2$, where x is in meters and t is in seconds. Therefore:
- A. the acceleration of the particle is 6 m/s^2
 - B. t cannot be negative
 - C. the particle follows a parabolic path
 - D. each second the velocity of the particle changes by 9.8 m/s
 - E. none of the above
- ans: E
22. Over a short interval near time $t = 0$ the coordinate of an automobile in meters is given by $x(t) = 27t - 4.0t^3$, where t is in seconds. At the end of 1.0 s the acceleration of the auto is:
- A. 27 m/s^2
 - B. 4.0 m/s^2
 - C. -4.0 m/s^2
 - D. -12 m/s^2
 - E. -24 m/s^2
- ans: E
23. Over a short interval, starting at time $t = 0$, the coordinate of an automobile in meters is given by $x(t) = 27t - 4.0t^3$, where t is in seconds. The magnitudes of the initial (at $t = 0$) velocity and acceleration of the auto respectively are:
- A. $0; 12 \text{ m/s}^2$
 - B. $0; 24 \text{ m/s}^2$
 - C. $27 \text{ m/s}; 0$
 - D. $27 \text{ m/s}; 12 \text{ m/s}^2$
 - E. $27 \text{ m/s}; 24 \text{ m/s}^2$
- ans: C
24. At time $t = 0$ a car has a velocity of 16 m/s . It slows down with an acceleration given by $-0.50t$, in m/s^2 for t in seconds. It stops at $t =$
- A. 64 s
 - B. 32 s
 - C. 16 s
 - D. 8.0 s
 - E. 4.0 s
- ans: D

25. At time $t = 0$ a car has a velocity of 16 m/s. It slows down with an acceleration given by $-0.50t$, in m/s^2 for t in seconds. At the end of 4.0 s it has traveled:
- A. 0
 - B. 12 m
 - C. 14 m
 - D. 25 m
 - E. 59 m
- ans: E
26. At time $t = 0$ a car has a velocity of 16 m/s. It slows down with an acceleration given by $-0.50t$, in m/s^2 for t in seconds. By the time it stops it has traveled:
- A. 15 m
 - B. 31 m
 - C. 62 m
 - D. 85 m
 - E. 100 m
- ans: D
27. Starting at time $t = 0$, an object moves along a straight line with velocity in m/s given by $v(t) = 98 - 2t^2$, where t is in seconds. When it momentarily stops its acceleration is:
- A. 0
 - B. -4.0 m/s^2
 - C. -9.8 m/s^2
 - D. -28 m/s^2
 - E. 49 m/s^2
- ans: D
28. Starting at time $t = 0$, an object moves along a straight line. Its coordinate in meters is given by $x(t) = 75t - 1.0t^3$, where t is in seconds. When it momentarily stops its acceleration is:
- A. 0
 - B. -73 m/s^2
 - C. -30 m/s^2
 - D. -9.8 m/s^2
 - E. $9.2 \times 10^3 \text{ m/s}^2$
- ans: C
29. A car, initially at rest, travels 20 m in 4 s along a straight line with constant acceleration. The acceleration of the car is:
- A. 0.4 m/s^2
 - B. 1.3 m/s^2
 - C. 2.5 m/s^2
 - D. 4.9 m/s^2
 - E. 9.8 m/s^2
- ans: C

30. A racing car traveling with constant acceleration increases its speed from 10 m/s to 50 m/s over a distance of 60 m. How long does this take?
- A. 2.0 s
 - B. 4.0 s
 - C. 5.0 s
 - D. 8.0 s
 - E. The time cannot be calculated since the speed is not constant
- ans: B
31. A car starts from rest and goes down a slope with a constant acceleration of 5 m/s^2 . After 5 s the car reaches the bottom of the hill. Its speed at the bottom of the hill, in meters per second, is:
- A. 1
 - B. 12.5
 - C. 25
 - D. 50
 - E. 160
- ans: C
32. A car moving with an initial velocity of 25 m/s north has a constant acceleration of 3 m/s^2 south. After 6 seconds its velocity will be:
- A. 7 m/s north
 - B. 7 m/s south
 - C. 43 m/s north
 - D. 20 m/s north
 - E. 20 m/s south
- ans: A
33. An object with an initial velocity of 12 m/s west experiences a constant acceleration of 4 m/s^2 west for 3 seconds. During this time the object travels a distance of:
- A. 12 m
 - B. 24 m
 - C. 36 m
 - D. 54 m
 - E. 144 m
- ans: D
34. How far does a car travel in 6 s if its initial velocity is 2 m/s and its acceleration is 2 m/s^2 in the forward direction?
- A. 12 m
 - B. 14 m
 - C. 24 m
 - D. 36 m
 - E. 48 m
- ans: E

35. At a stop light, a truck traveling at 15 m/s passes a car as it starts from rest. The truck travels at constant velocity and the car accelerates at 3 m/s^2 . How much time does the car take to catch up to the truck?
- A. 5 s
 - B. 10 s
 - C. 15 s
 - D. 20 s
 - E. 25 s

ans: B

36. A ball is in free fall. Its acceleration is:
- A. downward during both ascent and descent
 - B. downward during ascent and upward during descent
 - C. upward during ascent and downward during descent
 - D. upward during both ascent and descent
 - E. downward at all times except at the very top, when it is zero

ans: A

37. A ball is in free fall. Upward is taken to be the positive direction. The displacement of the ball during a short time interval is:
- A. positive during both ascent and descent
 - B. negative during both ascent and descent
 - C. negative during ascent and positive during descent
 - D. positive during ascent and negative during descent
 - E. none of the above

ans: D

38. A baseball is thrown vertically into the air. The acceleration of the ball at its highest point is:
- A. zero
 - B. g , down
 - C. g , up
 - D. $2g$, down
 - E. $2g$, up

ans: B

39. Which one of the following statements is correct for an object released from rest?
- A. The average velocity during the first second of time is 4.9 m/s
 - B. During each second the object falls 9.8 m
 - C. The acceleration changes by 9.8 m/s^2 every second
 - D. The object falls 9.8 m during the first second of time
 - E. The acceleration of the object is proportional to its weight

ans: A

40. A freely falling body has a constant acceleration of 9.8 m/s^2 . This means that:
- A. the body falls 9.8 m during each second
 - B. the body falls 9.8 m during the first second only
 - C. the speed of the body increases by 9.8 m/s during each second
 - D. the acceleration of the body increases by 9.8 m/s^2 during each second
 - E. the acceleration of the body decreases by 9.8 m/s^2 during each second
- ans: C
41. An object is shot vertically upward. While it is rising:
- A. its velocity and acceleration are both upward
 - B. its velocity is upward and its acceleration is downward
 - C. its velocity and acceleration are both downward
 - D. its velocity is downward and its acceleration is upward
 - E. its velocity and acceleration are both decreasing
- ans: B
42. An object is thrown straight up from ground level with a speed of 50 m/s . If $g = 10 \text{ m/s}^2$ its distance above ground level 1.0 s later is:
- A. 40 m
 - B. 45 m
 - C. 50 m
 - D. 55 m
 - E. 60 m
- ans: B
43. An object is thrown straight up from ground level with a speed of 50 m/s . If $g = 10 \text{ m/s}^2$ its distance above ground level 6.0 s later is:
- A. 0.00 m
 - B. 270 m
 - C. 330 m
 - D. 480 m
 - E. none of these
- ans: E
44. At a location where $g = 9.80 \text{ m/s}^2$, an object is thrown vertically down with an initial speed of 1.00 m/s . After 5.00 s the object will have traveled:
- A. 125 m
 - B. 127.5 m
 - C. 245 m
 - D. 250 m
 - E. 255 m
- ans: B

45. An object is thrown vertically upward at 35 m/s. Taking $g = 10 \text{ m/s}^2$, the velocity of the object 5 s later is:
- A. 7.0 m/s up
 - B. 15 m/s down
 - C. 15 m/s up
 - D. 85 m/s down
 - E. 85 m/s up
- ans: B
46. A feather, initially at rest, is released in a vacuum 12 m above the surface of the earth. Which of the following statements is correct?
- A. The maximum velocity of the feather is 9.8 m/s
 - B. The acceleration of the feather decreases until terminal velocity is reached
 - C. The acceleration of the feather remains constant during the fall
 - D. The acceleration of the feather increases during the fall
 - E. The acceleration of the feather is zero
- ans: C
47. An object is released from rest. How far does it fall during the second second of its fall?
- A. 4.9 m
 - B. 9.8 m
 - C. 15 m
 - D. 20 m
 - E. 25 m
- ans: C
48. A heavy ball falls freely, starting from rest. Between the third and fourth second of time it travels a distance of:
- A. 4.9 m
 - B. 9.8 m
 - C. 29.4 m
 - D. 34.3 m
 - E. 39.8 m
- ans: D
49. As a rocket is accelerating vertically upward at 9.8 m/s^2 near Earth's surface, it releases a projectile. Immediately after release the acceleration (in m/s^2) of the projectile is:
- A. 9.8 down
 - B. 0
 - C. 9.8 up
 - D. 19.6 up
 - E. none of the above
- ans: A

50. A stone is released from a balloon that is descending at a constant speed of 10 m/s. Neglecting air resistance, after 20 s the speed of the stone is:
- A. 2160 m/s
 - B. 1760 m/s
 - C. 206 m/s
 - D. 196 m/s
 - E. 186 m/s
- ans: C
51. An object dropped from the window of a tall building hits the ground in 12.0 s. If its acceleration is 9.80 m/s^2 , the height of the window above the ground is:
- A. 29.4 m
 - B. 58.8 m
 - C. 118 m
 - D. 353 m
 - E. 706 m
- ans: E
52. Neglecting the effect of air resistance a stone dropped off a 175-m high building lands on the ground in:
- A. 3 s
 - B. 4 s
 - C. 6 s
 - D. 18 s
 - E. 36 s
- ans: C
53. A stone is thrown vertically upward with an initial speed of 19.5 m/s. It will rise to a maximum height of:
- A. 4.9 m
 - B. 9.8 m
 - C. 19.4 m
 - D. 38.8 m
 - E. none of these
- ans: C
54. A baseball is hit straight up and is caught by the catcher 2.0 s later. The maximum height of the ball during this interval is:
- A. 4.9 m
 - B. 7.4 m
 - C. 9.8 m
 - D. 12.6 m
 - E. 19.6 m
- ans: A

55. An object is thrown straight down with an initial speed of 4 m/s from a window which is 8 m above the ground. The time it takes the object to reach the ground is:
- A. 0.80 s
 - B. 0.93 s
 - C. 1.3 s
 - D. 1.7 s
 - E. 2.0 s
- ans: B
56. A stone is released from rest from the edge of a building roof 190 m above the ground. Neglecting air resistance, the speed of the stone, just before striking the ground, is:
- A. 43 m/s
 - B. 61 m/s
 - C. 120 m/s
 - D. 190 m/s
 - E. 1400 m/s
- ans: B
57. An object is thrown vertically upward with a certain initial velocity in a world where the acceleration due to gravity is 19.6 m/s^2 . The height to which it rises is that to which the object would rise if thrown upward with the same initial velocity on the Earth. Neglect friction.
- A. half
 - B. $\sqrt{2}$ times
 - C. twice
 - D. four times
 - E. cannot be calculated from the given data
- ans: A
58. A projectile is shot vertically upward with a given initial velocity. It reaches a maximum height of 100 m. If, on a second shot, the initial velocity is doubled then the projectile will reach a maximum height of:
- A. 70.7 m
 - B. 141.4 m
 - C. 200 m
 - D. 241 m
 - E. 400 m
- ans: E
59. One object is thrown vertically upward with an initial velocity of 100 m/s and another object with an initial velocity of 10 m/s. The maximum height reached by the first object will be that of the other.
- A. 10 times
 - B. 100 times
 - C. 1000 times
 - D. 10,000 times
 - E. none of these
- ans: B

60. The area under a velocity-time graph represents:
- A. acceleration
 - B. change in acceleration
 - C. speed
 - D. change in velocity
 - E. displacement
- ans: E
61. Displacement can be obtained from:
- A. the slope of an acceleration-time graph
 - B. the slope of a velocity-time graph
 - C. the area under an acceleration-time graph
 - D. the area under a velocity-time graph
 - E. the slope of an acceleration-time graph
- ans: D
62. An object has a constant acceleration of 3 m/s^2 . The coordinate versus time graph for this object has a slope:
- A. that increases with time
 - B. that is constant
 - C. that decreases with time
 - D. of 3 m/s
 - E. of 3 m/s^2
- ans: A
63. The coordinate-time graph of an object is a straight line with a positive slope. The object has:
- A. constant displacement
 - B. steadily increasing acceleration
 - C. steadily decreasing acceleration
 - D. constant velocity
 - E. steadily increasing velocity
- ans: D

64. Which of the following five coordinate versus time graphs represents the motion of an object moving with a constant nonzero speed?

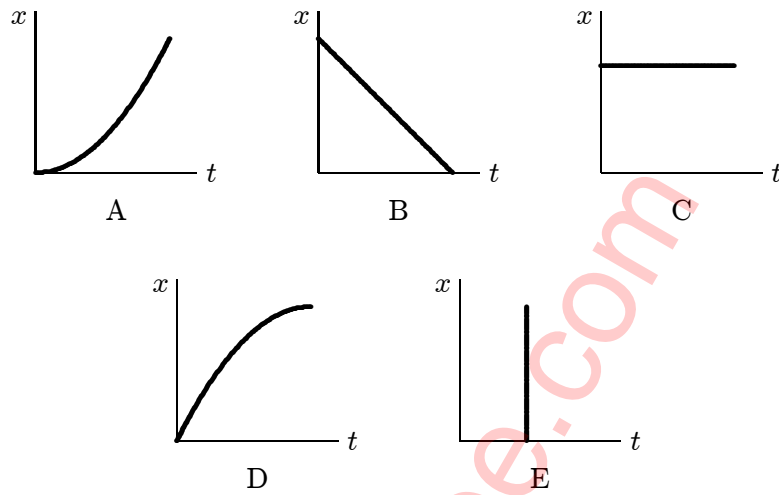

ans: B

65. Which of the following five acceleration versus time graphs is correct for an object moving in a straight line at a constant velocity of 20 m/s?

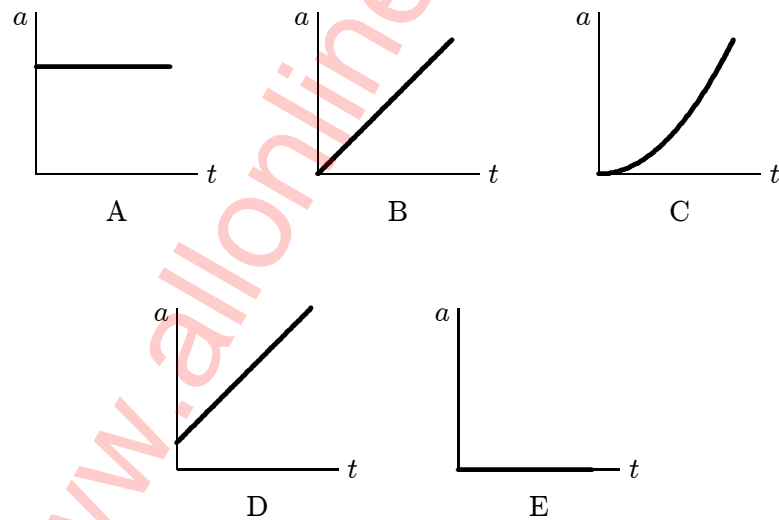

ans: E

66. Which of the following five coordinate versus time graphs represents the motion of an object whose speed is increasing?

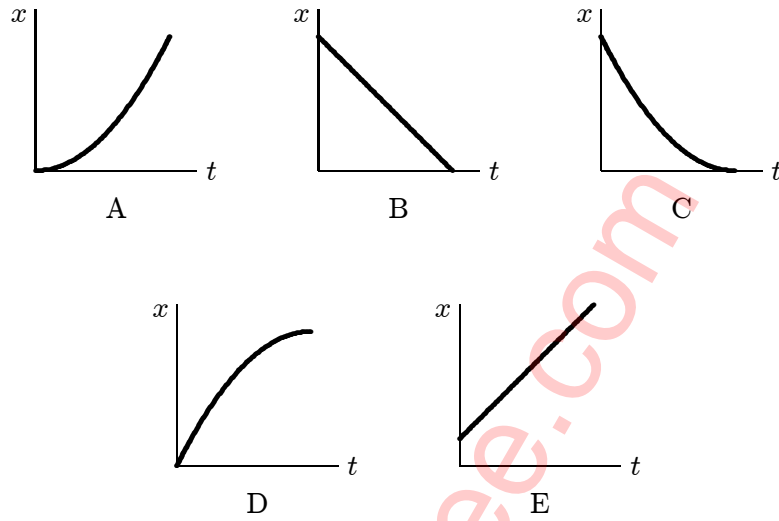

ans: A

67. A car accelerates from rest on a straight road. A short time later, the car decelerates to a stop and then returns to its original position in a similar manner, by speeding up and then slowing to a stop. Which of the following five coordinate versus time graphs best describes the motion?

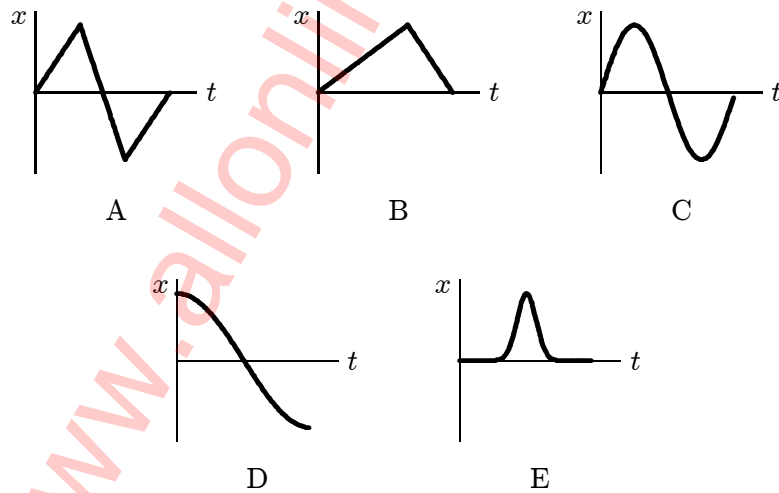

ans: E

68. The acceleration of an object, starting from rest, is shown in the graph below. Other than at $t = 0$, when is the velocity of the object equal to zero?

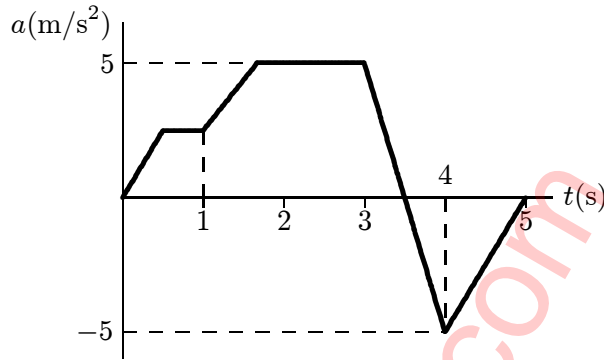

- A. During the interval from 1.0 s to 3.0 s
- B. At $t = 3.5$ s
- C. At $t = 4.0$ s
- D. At $t = 5.0$ s
- E. At no other time less than or equal to 5 s

ans: E

69. An elevator is moving upward with constant acceleration. The dashed curve shows the position y of the ceiling of the elevator as a function of the time t . At the instant indicated by the dot, a bolt breaks loose and drops from the ceiling. Which curve best represents the position of the bolt as a function of time?

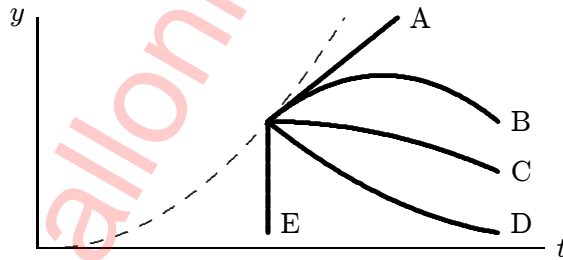

ans: B

70. The diagram shows a velocity-time graph for a car moving in a straight line. At point Q the car must be:

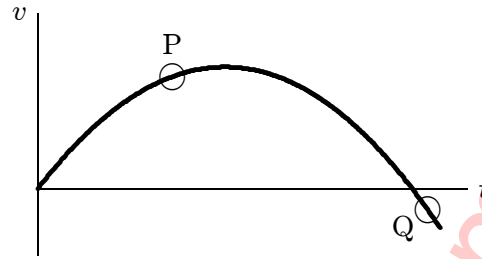

- A. moving with zero acceleration
 - B. traveling downhill
 - C. traveling below ground-level
 - D. reducing speed
 - E. traveling in the reverse direction to that at point P
- ans: E

71. The diagram shows a velocity-time graph for a car moving in a straight line. At point P the car must be:

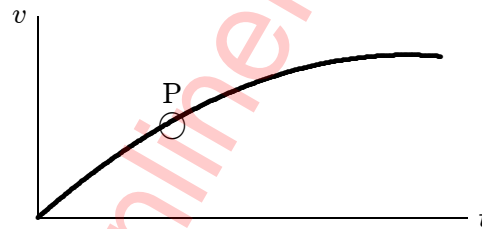

- A. moving with zero acceleration
 - B. climbing the hill
 - C. accelerating
 - D. stationary
 - E. moving at about 45° with respect to the x axis
- ans: C

72. The graph represents the straight line motion of a car. How far does the car travel between $t = 2$ s and $t = 5$ s?

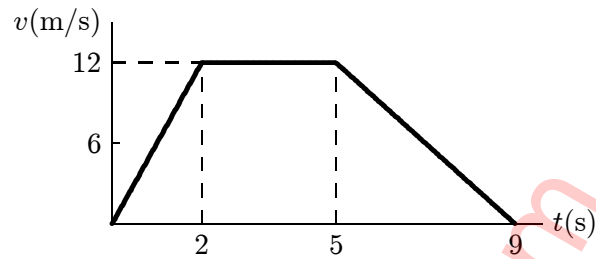

- A. 4 m
- B. 12 m
- C. 24 m
- D. 36 m
- E. 60 m

ans: D

73. The diagram represents the straight line motion of a car. Which of the following statements is true?

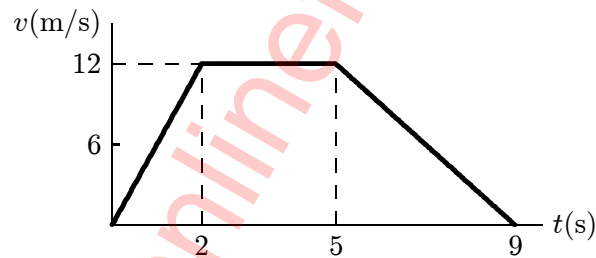

- A. The car accelerates, stops, and reverses
- B. The car accelerates at 6 m/s^2 for the first 2 s
- C. The car is moving for a total time of 12 s
- D. The car decelerates at 12 m/s^2 for the last 4 s
- E. The car returns to its starting point when $t = 9$ s

ans: B

74. Consider the following five graphs (note the axes carefully). Which of these represents motion at constant speed?

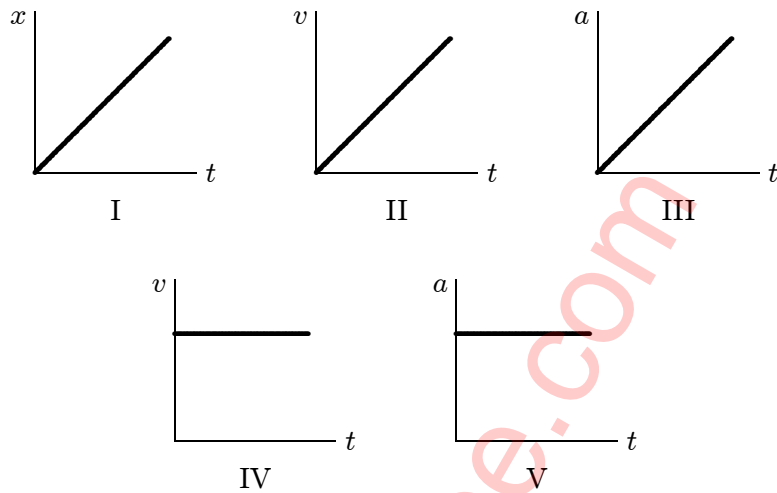

- A. IV only
 B. IV and V only
 C. I, II, and III only
 D. I and II only
 E. I and IV only

ans: E

75. An object is dropped from rest. Which of the following five graphs correctly represents its motion? The positive direction is taken to be downward.

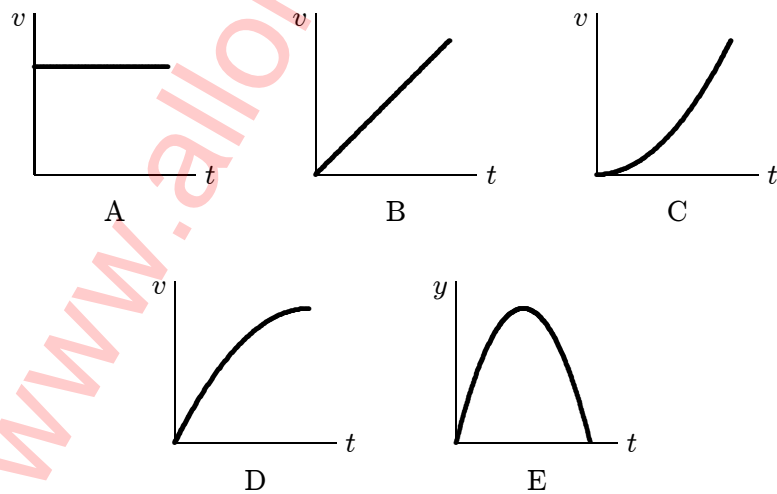

ans: B

76. A stone is dropped from a cliff. The graph (carefully note the axes) which best represents its motion while it falls is:

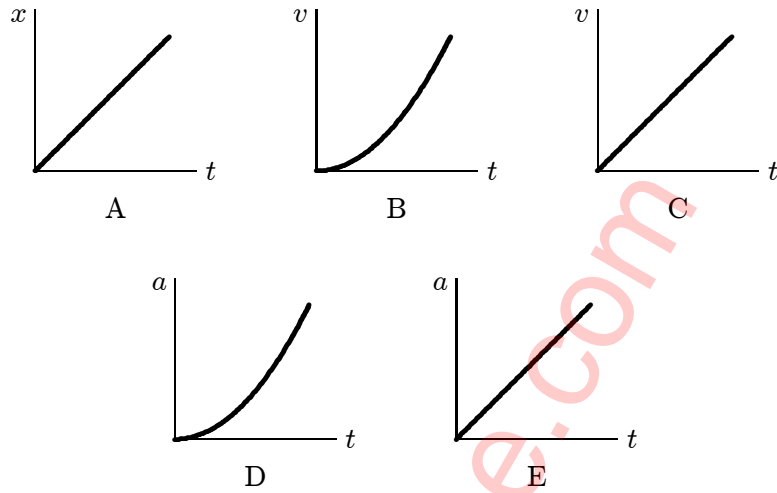

ans: C

77. An object is thrown vertically into the air. Which of the following five graphs represents the velocity (v) of the object as a function of the time (t)? The positive direction is taken to be upward.

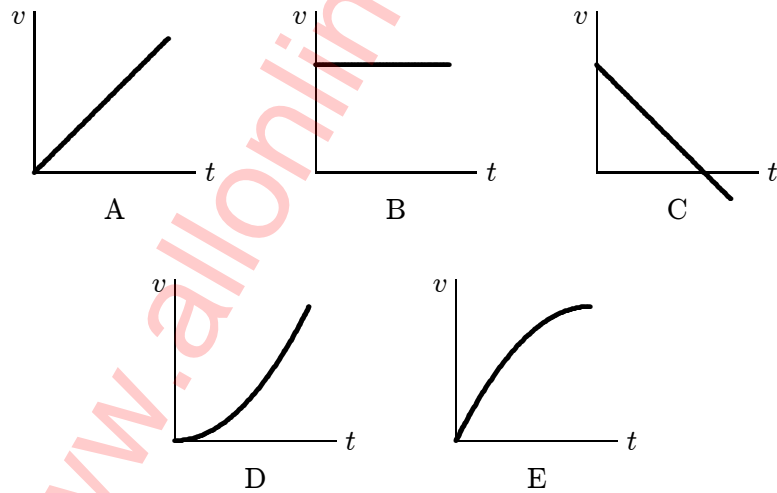

ans: C

Chapter 3: VECTORS

1. We say that the displacement of a particle is a vector quantity. Our best justification for this assertion is:
- A. displacement can be specified by a magnitude and a direction
 - B. operating with displacements according to the rules for manipulating vectors leads to results in agreement with experiments
 - C. a displacement is obviously not a scalar
 - D. displacement can be specified by three numbers
 - E. displacement is associated with motion

ans: B

2. The vectors \vec{a} , \vec{b} , and \vec{c} are related by $\vec{c} = \vec{b} - \vec{a}$. Which diagram below illustrates this relationship?

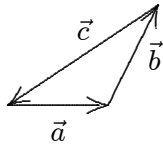

A

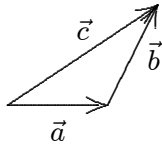

B



C

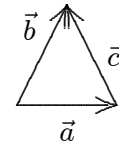

D

- E. None of these

ans: D

3. A vector of magnitude 3 CANNOT be added to a vector of magnitude 4 so that the magnitude of the resultant is:
- A. zero
 - B. 1
 - C. 3
 - D. 5
 - E. 7

ans: A

4. A vector of magnitude 20 is added to a vector of magnitude 25. The magnitude of this sum might be:
- A. zero
 - B. 3
 - C. 12
 - D. 47
 - E. 50

ans: C

5. A vector \vec{S} of magnitude 6 and another vector \vec{T} have a sum of magnitude 12. The vector \vec{T} :
- must have a magnitude of at least 6 but no more than 18
 - may have a magnitude of 20
 - cannot have a magnitude greater than 12
 - must be perpendicular to \vec{S}
 - must be perpendicular to the vector sum

ans: A

6. The vector $-\vec{A}$ is:
- greater than \vec{A} in magnitude
 - less than \vec{A} in magnitude
 - in the same direction as \vec{A}
 - in the direction opposite to \vec{A}
 - perpendicular to \vec{A}

ans: D

7. The vector \vec{V}_3 in the diagram is equal to:

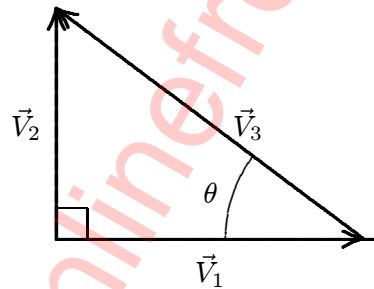

- $\vec{V}_1 - \vec{V}_2$
- $\vec{V}_1 + \vec{V}_2$
- $\vec{V}_2 - \vec{V}_1$
- $\vec{V}_1 \cos \theta$
- $\vec{V}_1 / (\cos \theta)$

ans: C

8. If $|\vec{A} + \vec{B}|^2 = A^2 + B^2$, then:
- \vec{A} and \vec{B} must be parallel and in the same direction
 - \vec{A} and \vec{B} must be parallel and in opposite directions
 - either \vec{A} or \vec{B} must be zero
 - the angle between \vec{A} and \vec{B} must be 60°
 - none of the above is true

ans: E

9. If $|\vec{A} + \vec{B}| = A + B$ and neither \vec{A} nor \vec{B} vanish, then:

- A. \vec{A} and \vec{B} are parallel and in the same direction
- B. \vec{A} and \vec{B} are parallel and in opposite directions
- C. the angle between \vec{A} and \vec{B} is 45°
- D. the angle between \vec{A} and \vec{B} is 60°
- E. \vec{A} is perpendicular to \vec{B}

ans: A

10. If $|\vec{A} - \vec{B}| = A + B$ and neither \vec{A} nor \vec{B} vanish, then:

- A. \vec{A} and \vec{B} are parallel and in the same direction
- B. \vec{A} and \vec{B} are parallel and in opposite directions
- C. the angle between \vec{A} and \vec{B} is 45°
- D. the angle between \vec{A} and \vec{B} is 60°
- E. \vec{A} is perpendicular to \vec{B}

ans: B

11. Four vectors (\vec{A} , \vec{B} , \vec{C} , \vec{D}) all have the same magnitude. The angle θ between adjacent vectors is 45° as shown. The correct vector equation is:

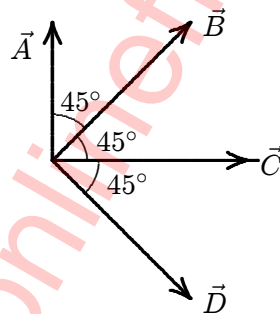

- A. $\vec{A} - \vec{B} - \vec{C} + \vec{D} = 0$
- B. $\vec{B} + \vec{D} - \sqrt{2}\vec{C} = 0$
- C. $\vec{A} + \vec{B} = \vec{B} + \vec{D}$
- D. $\vec{A} + \vec{B} + \vec{C} + \vec{D} = 0$
- E. $(\vec{A} + \vec{C})/\sqrt{2} = -\vec{B}$

ans: B

12. Vectors \vec{A} and \vec{B} lie in the xy plane. We can deduce that $\vec{A} = \vec{B}$ if:

- A. $A_x^2 + A_y^2 = B_x^2 + B_y^2$
- B. $A_x + A_y = B_x + B_y$
- C. $A_x = B_x$ and $A_y = B_y$
- D. $A_y/A_x = B_y/B_x$
- E. $A_x = A_y$ and $B_x = B_y$

ans: C

13. A vector has a magnitude of 12. When its tail is at the origin it lies between the positive x axis and the negative y axis and makes an angle of 30° with the x axis. Its y component is:
- A. $6/\sqrt{3}$
 - B. $-6\sqrt{3}$
 - C. 6
 - D. -6
 - E. 12

ans: D

14. If the x component of a vector \vec{A} , in the xy plane, is half as large as the magnitude of the vector, the tangent of the angle between the vector and the x axis is:
- A. $\sqrt{3}$
 - B. $1/2$
 - C. $\sqrt{3}/2$
 - D. $3/2$
 - E. 3

ans: D

15. If $\vec{A} = (6\text{ m})\hat{i} - (8\text{ m})\hat{j}$ then $4\vec{A}$ has magnitude:

- A. 10 m
- B. 20 m
- C. 30 m
- D. 40 m
- E. 50 m

ans: D

16. A vector has a component of 10 m in the $+x$ direction, a component of 10 m in the $+y$ direction, and a component of 5 m in the $+z$ direction. The magnitude of this vector is:

- A. zero
- B. 15 m
- C. 20 m
- D. 25 m
- E. 225 m

ans: B

17. Let $\vec{V} = (2.00\text{ m})\hat{i} + (6.00\text{ m})\hat{j} - (3.00\text{ m})\hat{k}$. The magnitude of \vec{V} is:

- A. 5.00 m
- B. 5.57 m
- C. 7.00 m
- D. 7.42 m
- E. 8.54 m

ans: C

18. A vector in the xy plane has a magnitude of 25 m and an x component of 12 m. The angle it makes with the positive x axis is:
- A. 26°
 - B. 29°
 - C. 61°
 - D. 64°
 - E. 241°
- ans: C

19. The angle between $\vec{A} = (25 \text{ m})\hat{i} + (45 \text{ m})\hat{j}$ and the positive x axis is:
- A. 29°
 - B. 61°
 - C. 151°
 - D. 209°
 - E. 241°
- ans: B

20. The angle between $\vec{A} = (-25 \text{ m})\hat{i} + (45 \text{ m})\hat{j}$ and the positive x axis is:
- A. 29°
 - B. 61°
 - C. 119°
 - D. 151°
 - E. 209°
- ans: C

21. Let $\vec{A} = (2 \text{ m})\hat{i} + (6 \text{ m})\hat{j} - (3 \text{ m})\hat{k}$ and $\vec{B} = (4 \text{ m})\hat{i} + (2 \text{ m})\hat{j} + (1 \text{ m})\hat{k}$. The vector sum $\vec{S} = \vec{A} + \vec{B}$ is:
- A. $(6 \text{ m})\hat{i} + (8 \text{ m})\hat{j} - (2 \text{ m})\hat{k}$
 - B. $(-2 \text{ m})\hat{i} + (4 \text{ m})\hat{j} - (4 \text{ m})\hat{k}$
 - C. $(2 \text{ m})\hat{i} - (4 \text{ m})\hat{j} + (4 \text{ m})\hat{k}$
 - D. $(8 \text{ m})\hat{i} + (12 \text{ m})\hat{j} - (3 \text{ m})\hat{k}$
 - E. none of these
- ans: A

22. Let $\vec{A} = (2 \text{ m})\hat{i} + (6 \text{ m})\hat{j} - (3 \text{ m})\hat{k}$ and $\vec{B} = (4 \text{ m})\hat{i} + (2 \text{ m})\hat{j} + (1 \text{ m})\hat{k}$. The vector difference $\vec{D} = \vec{A} - \vec{B}$ is:
- A. $(6 \text{ m})\hat{i} + (8 \text{ m})\hat{j} - (2 \text{ m})\hat{k}$
 - B. $(-2 \text{ m})\hat{i} + (4 \text{ m})\hat{j} - (4 \text{ m})\hat{k}$
 - C. $(2 \text{ m})\hat{i} - (4 \text{ m})\hat{j} + (4 \text{ m})\hat{k}$
 - D. $(8 \text{ m})\hat{i} + (12 \text{ m})\hat{j} - (3 \text{ m})\hat{k}$
 - E. none of these
- ans: B

23. If $\vec{A} = (2 \text{ m})\hat{i} - (3 \text{ m})\hat{j}$ and $\vec{B} = (1 \text{ m})\hat{i} - (2 \text{ m})\hat{j}$, then $\vec{A} - 2\vec{B} =$
- $(1 \text{ m})\hat{j}$
 - $(-1 \text{ m})\hat{j}$
 - $(4 \text{ m})\hat{i} - (7 \text{ m})\hat{j}$
 - $(4 \text{ m})\hat{i} + (1 \text{ m})\hat{j}$
 - $(-4 \text{ m})\hat{i} + (7 \text{ m})\hat{j}$

ans: A

24. In the diagram, \vec{A} has magnitude 12 m and \vec{B} has magnitude 8 m. The x component of $\vec{A} + \vec{B}$ is about:

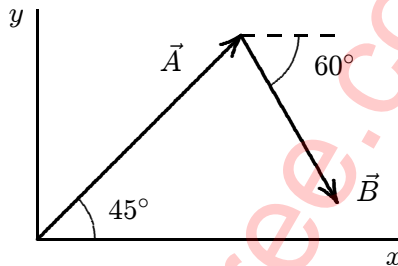

- 5.5 m
- 7.6 m
- 12 m
- 14 m
- 15 m

ans: C

25. A certain vector in the xy plane has an x component of 4 m and a y component of 10 m. It is then rotated in the xy plane so its x component is doubled. Its new y component is about:

- 20 m
- 7.2 m
- 5.0 m
- 4.5 m
- 2.2 m

ans: B

26. Vectors \vec{A} and \vec{B} each have magnitude L . When drawn with their tails at the same point, the angle between them is 30° . The value of $\vec{A} \cdot \vec{B}$ is:

- zero
- L^2
- $\sqrt{3}L^2/2$
- $2L^2$
- none of these

ans: C

27. Let $\vec{A} = (2\text{ m})\hat{i} + (6\text{ m})\hat{j} - (3\text{ m})\hat{k}$ and $\vec{B} = (4\text{ m})\hat{i} + (2\text{ m})\hat{j} + (1\text{ m})\hat{k}$. Then $\vec{A} \cdot \vec{B} =$
- A. $(8\text{ m})\hat{i} + (12\text{ m})\hat{j} - (3\text{ m})\hat{k}$
 - B. $(12\text{ m})\hat{i} - (14\text{ m})\hat{j} - (20\text{ m})\hat{k}$
 - C. 23 m^2
 - D. 17 m^2
 - E. none of these
- ans: D
28. Two vectors have magnitudes of 10 m and 15 m. The angle between them when they are drawn with their tails at the same point is 65° . The component of the longer vector along the line of the shorter is:
- A. 0
 - B. 4.2 m
 - C. 6.3 m
 - D. 9.1 m
 - E. 14 m
- ans: C
29. Let $\vec{S} = (1\text{ m})\hat{i} + (2\text{ m})\hat{j} + (2\text{ m})\hat{k}$ and $\vec{T} = (3\text{ m})\hat{i} + (4\text{ m})\hat{k}$. The angle between these two vectors is given by:
- A. $\cos^{-1}(14/15)$
 - B. $\cos^{-1}(11/225)$
 - C. $\cos^{-1}(104/225)$
 - D. $\cos^{-1}(11/15)$
 - E. cannot be found since \vec{S} and \vec{T} do not lie in the same plane
- ans: D
30. Two vectors lie with their tails at the same point. When the angle between them is increased by 20° their scalar product has the same magnitude but changes from positive to negative. The original angle between them was:
- A. 0
 - B. 60°
 - C. 70°
 - D. 80°
 - E. 90°
- ans: D
31. If the magnitude of the sum of two vectors is less than the magnitude of either vector, then:
- A. the scalar product of the vectors must be negative
 - B. the scalar product of the vectors must be positive
 - C. the vectors must be parallel and in opposite directions
 - D. the vectors must be parallel and in the same direction
 - E. none of the above
- ans: A

32. If the magnitude of the sum of two vectors is greater than the magnitude of either vector, then:
- the scalar product of the vectors must be negative
 - the scalar product of the vectors must be positive
 - the vectors must be parallel and in opposite directions
 - the vectors must be parallel and in the same direction
 - none of the above
- ans: E
33. Vectors \vec{A} and \vec{B} each have magnitude L . When drawn with their tails at the same point, the angle between them is 60° . The magnitude of the vector product $\vec{A} \times \vec{B}$ is:
- $L^2/2$
 - L^2
 - $\sqrt{3}L^2/2$
 - $2L^2$
 - none of these
- ans: C
34. Two vectors lie with their tails at the same point. When the angle between them is increased by 20° the magnitude of their vector product doubles. The original angle between them was about:
- 0
 - 18°
 - 25°
 - 45°
 - 90°
- ans: B
35. Two vectors have magnitudes of 10 m and 15 m. The angle between them when they are drawn with their tails at the same point is 65° . The component of the longer vector along the line perpendicular to the shorter vector, in the plane of the vectors, is:
- 0
 - 4.2 m
 - 6.3 m
 - 9.1 m
 - 14 m
- ans: E
36. The two vectors $(3\text{ m})\hat{i} - (2\text{ m})\hat{j}$ and $(2\text{ m})\hat{i} + (3\text{ m})\hat{j} - (2\text{ m})\hat{k}$ define a plane. It is the plane of the triangle with both tails at one vertex and each head at one of the other vertices. Which of the following vectors is perpendicular to the plane?
- $(4\text{ m})\hat{i} + (6\text{ m})\hat{j} + (13\text{ m})\hat{k}$
 - $(-4\text{ m})\hat{i} + (6\text{ m})\hat{j} + (13\text{ m})\hat{k}$
 - $(4\text{ m})\hat{i} - (6\text{ m})\hat{j} + (13\text{ m})\hat{k}$
 - $(4\text{ m})\hat{i} + (6\text{ m})\hat{j} - (13\text{ m})\hat{k}$
 - $(4\text{ m})\hat{i} + (6\text{ m})\hat{j}$
- ans: A

37. Let $\vec{R} = \vec{S} \times \vec{T}$ and $\theta \neq 90^\circ$, where θ is the angle between \vec{S} and \vec{T} when they are drawn with their tails at the same point. Which of the following is NOT true?

A. $|\vec{R}| = |\vec{S}||\vec{T}|\sin\theta$

B. $-\vec{R} = \vec{T} \times \vec{S}$

C. $\vec{R} \cdot \vec{S} = 0$

D. $\vec{R} \cdot \vec{T} = 0$

E. $\vec{S} \cdot \vec{T} = 0$

ans: E

38. The value of $\hat{i} \cdot (\hat{j} \times \hat{k})$ is:

A. zero

B. +1

C. -1

D. 3

E. $\sqrt{3}$

ans: B

39. The value of $\hat{k} \cdot (\hat{k} \times \hat{i})$ is:

A. zero

B. +1

C. -1

D. 3

E. $\sqrt{3}$

ans: A

www.allonlinefree.com

Chapter 4: MOTION IN TWO AND THREE DIMENSIONS

1. Velocity is defined as:
 - A. rate of change of position with time
 - B. position divided by time
 - C. rate of change of acceleration with time
 - D. a speeding up or slowing down
 - E. change of positionans: A
2. Acceleration is defined as:
 - A. rate of change of position with time
 - B. speed divided by time
 - C. rate of change of velocity with time
 - D. a speeding up or slowing down
 - E. change of velocityans: C
3. Which of the following is a scalar quantity?
 - A. Speed
 - B. Velocity
 - C. Displacement
 - D. Acceleration
 - E. None of theseans: A
4. Which of the following is a vector quantity?
 - A. Mass
 - B. Density
 - C. Speed
 - D. Temperature
 - E. None of theseans: E
5. Which of the following is NOT an example of accelerated motion?
 - A. Vertical component of projectile motion
 - B. Circular motion at constant speed
 - C. A swinging pendulum
 - D. Earth's motion about sun
 - E. Horizontal component of projectile motionans: E

6. A particle goes from $x = -2\text{ m}$, $y = 3\text{ m}$, $z = 1\text{ m}$ to $x = 3\text{ m}$, $y = -1\text{ m}$, $z = 4\text{ m}$. Its displacement is:
- $(1\text{ m})\hat{i} + (2\text{ m})\hat{j} + (5\text{ m})\hat{k}$
 - $(5\text{ m})\hat{i} - (4\text{ m})\hat{j} + (3\text{ m})\hat{k}$
 - $-(5\text{ m})\hat{i} + (4\text{ m})\hat{j} - (3\text{ m})\hat{k}$
 - $-(1\text{ m})\hat{i} - (2\text{ m})\hat{j} - (5\text{ m})\hat{k}$
 - $-(5\text{ m})\hat{i} - (2\text{ m})\hat{j} + (3\text{ m})\hat{k}$
- ans: B
7. A jet plane in straight horizontal flight passes over your head. When it is directly above you, the sound seems to come from a point behind the plane in a direction 30° from the vertical. The speed of the plane is:
- the same as the speed of sound
 - half the speed of sound
 - three-fifths the speed of sound
 - 0.866 times the speed of sound
 - twice the speed of sound
- ans: B
8. A plane traveling north at 200 m/s turns and then travels south at 200 m/s . The change in its velocity is:
- zero
 - 200 m/s north
 - 200 m/s south
 - 400 m/s north
 - 400 m/s south
- ans: E
9. Two bodies are falling with negligible air resistance, side by side, above a horizontal plane. If one of the bodies is given an additional horizontal acceleration during its descent, it:
- strikes the plane at the same time as the other body
 - strikes the plane earlier than the other body
 - has the vertical component of its velocity altered
 - has the vertical component of its acceleration altered
 - follows a straight line path along the resultant acceleration vector
- ans: A
10. The velocity of a projectile equals its initial velocity added to:
- a constant horizontal velocity
 - a constant vertical velocity
 - a constantly increasing horizontal velocity
 - a constantly increasing downward velocity
 - a constant velocity directed at the target
- ans: D

11. A stone thrown from the top of a tall building follows a path that is:
- circular
 - made of two straight line segments
 - hyperbolic
 - parabolic
 - a straight line
- ans: D
12. Identical guns fire identical bullets horizontally at the same speed from the same height above level planes, one on the Earth and one on the Moon. Which of the following three statements is/are true?
- The horizontal distance traveled by the bullet is greater for the Moon.
 - The flight time is less for the bullet on the Earth.
 - The velocity of the bullets at impact are the same.
- III only
 - I and II only
 - I and III only
 - II and III only
 - I, II, III
- ans: B
13. A stone is thrown horizontally and follows the path XYZ shown. The direction of the acceleration of the stone at point Y is:

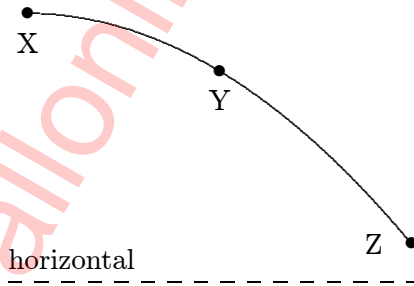

- ↓
 -
 - ↘
 - ↙
 - ↗
- ans: A

14. A bullet shot horizontally from a gun:
- strikes the ground much later than one dropped vertically from the same point at the same instant
 - never strikes the ground
 - strikes the ground at approximately the same time as one dropped vertically from the same point at the same instant
 - travels in a straight line
 - strikes the ground much sooner than one dropped from the same point at the same instant
- ans: C
15. A bomber flying in level flight with constant velocity releases a bomb before it is over the target. Neglecting air resistance, which one of the following is NOT true?
- The bomber is over the target when the bomb strikes
 - The acceleration of the bomb is constant
 - The horizontal velocity of the plane equals the vertical velocity of the bomb when it hits the target
 - The bomb travels in a curved path
 - The time of flight of the bomb is independent of the horizontal speed of the plane
- ans: C
16. The airplane shown is in level flight at an altitude of 0.50 km and a speed of 150 km/h. At what distance d should it release a heavy bomb to hit the target X? Take $g = 10 \text{ m/s}^2$.

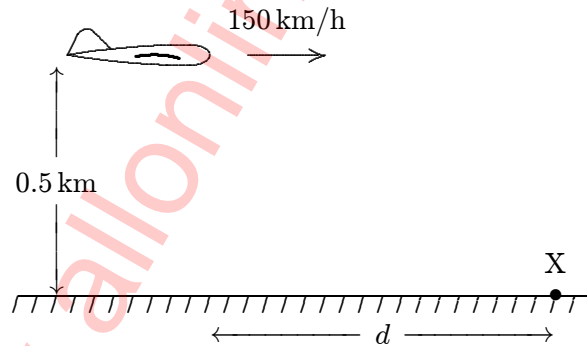

- 150 m
 - 295 m
 - 420 m
 - 2550 m
 - 15,000 m
- ans: C

17. An object is shot from the back of a railroad flatcar moving at 40 km/h on a straight horizontal road. The launcher is aimed upward, perpendicular to the bed of the flatcar. The object falls:
- A. in front of the flatcar
 - B. behind the flatcar
 - C. on the flatcar
 - D. either behind or in front of the flatcar, depending on the initial speed of the object
 - E. to the side of the flatcar

ans: C

18. A ball is thrown horizontally from the top of a 20-m high hill. It strikes the ground at an angle of 45° . With what speed was it thrown?

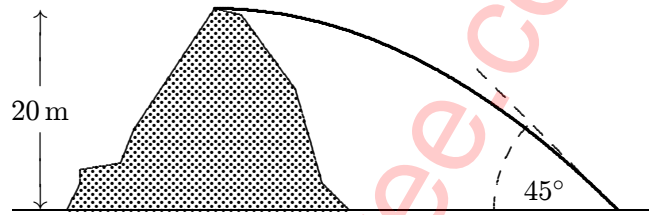

- A. 14 m/s
- B. 20 m/s
- C. 28 m/s
- D. 32 m/s
- E. 40 m/s

ans: B

19. A stone is thrown outward from the top of a 59.4-m high cliff with an upward velocity component of 19.5 m/s. How long is stone in the air?

- A. 4.00 s
- B. 5.00 s
- C. 6.00 s
- D. 7.00 s
- E. 8.00 s

ans: C

20. A large cannon is fired from ground level over level ground at an angle of 30° above the horizontal. The muzzle speed is 980 m/s. Neglecting air resistance, the projectile will travel what horizontal distance before striking the ground?

- A. 4.3 km
- B. 8.5 km
- C. 43 km
- D. 85 km
- E. 170 km

ans: D

21. A boy on the edge of a vertical cliff 20 m high throws a stone horizontally outward with a speed of 20 m/s. It strikes the ground at what horizontal distance from the foot of the cliff? Use $g = 10 \text{ m/s}^2$.
- A. 10 m
 - B. 40 m
 - C. 50 m
 - D. $50\sqrt{5}$ m
 - E. none of these
- ans: B

22. Which of the curves on the graph below best represents the vertical component v_y of the velocity versus the time t for a projectile fired at an angle of 45° above the horizontal?

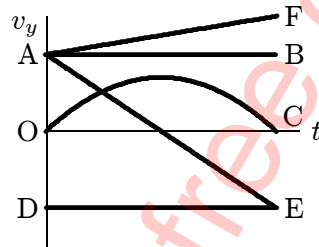

- A. OC
 - B. DE
 - C. AB
 - D. AE
 - E. AF
- ans: D

23. A cannon fires a projectile as shown. The dashed line shows the trajectory in the absence of gravity; points MNOP correspond to the position of the projectile at one second intervals. If $g = 10 \text{ m/s}^2$, the lengths X,Y,Z are:

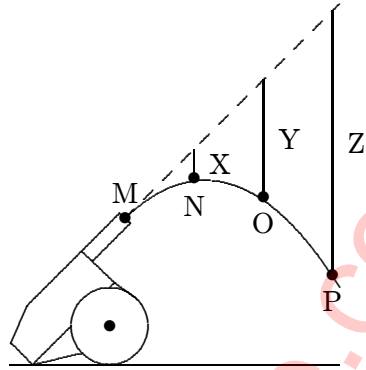

- A. 5 m, 10 m, 15 m
 B. 5 m, 20 m, 45 m
 C. 10 m, 40 m, 90 m
 D. 10 m, 20 m, 30 m
 E. 0.2 m, 0.8 m, 1.8 m

ans: B

24. A dart is thrown horizontally toward X at 20 m/s as shown. It hits Y 0.1 s later. The distance XY is:

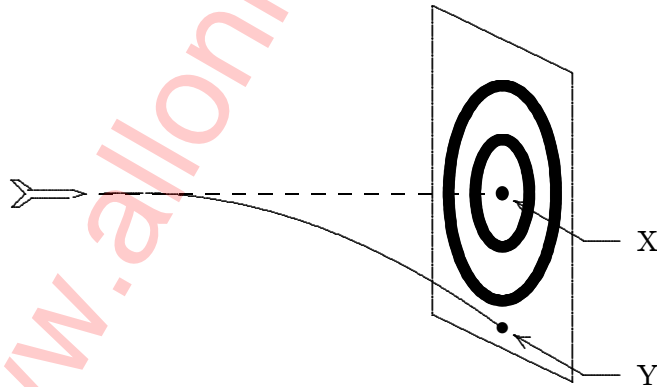

- A. 2 m
 B. 1 m
 C. 0.5 m
 D. 0.1 m
 E. 0.05 m

ans: E

25. A projectile is fired from ground level over level ground with an initial velocity that has a vertical component of 20 m/s and a horizontal component of 30 m/s . Using $g = 10 \text{ m/s}^2$, the distance from launching to landing points is:
- 40 m
 - 60 m
 - 80 m
 - 120 m
 - 180 m
- ans: D

26. An object, tied to a string, moves in a circle at constant speed on a horizontal surface as shown. The direction of the displacement of this object, as it travels from W to X is:

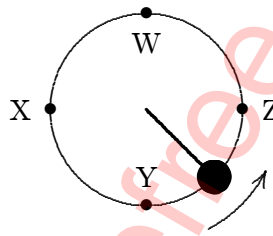

- \leftarrow
 - \downarrow
 - \uparrow
 - \nearrow
 - \swarrow
- ans: E

27. A toy racing car moves with constant speed around the circle shown below. When it is at point A its coordinates are $x = 0$, $y = 3 \text{ m}$ and its velocity is $(6 \text{ m/s})\hat{i}$. When it is at point B its velocity and acceleration are:

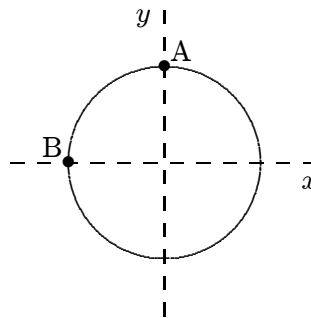

- $-(6 \text{ m/s})\hat{j}$ and $(12 \text{ m/s}^2)\hat{i}$, respectively
 - $(6 \text{ m/s})\hat{i}$ and $-(12 \text{ m/s}^2)\hat{i}$, respectively
 - $(6 \text{ m/s})\hat{j}$ and $(12 \text{ m/s}^2)\hat{i}$, respectively
 - $(6 \text{ m/s})\hat{i}$ and $(2 \text{ m/s}^2)\hat{j}$, respectively
 - $(6 \text{ m/s})\hat{j}$ and 0, respectively
- ans: C

28. An airplane makes a gradual 90° turn while flying at a constant speed of 200 m/s . The process takes 20.0 seconds to complete. For this turn the magnitude of the average acceleration of the plane is:
- A. zero
 - B. 40 m/s^2
 - C. 20 m/s^2
 - D. 14 m/s^2
 - E. 10 m/s^2
- ans: D
29. An airplane is flying north at 500 km/h . It makes a gradual 180° turn at constant speed, changing its direction of travel from north through east to south. The process takes 40 s . The average acceleration of the plane for this turn (in $\text{km/h}\cdot\text{s}$) is:
- A. $12.5\text{ km/h}\cdot\text{s}$, north
 - B. $12.5\text{ km/h}\cdot\text{s}$, east
 - C. $12.5\text{ km/h}\cdot\text{s}$, south
 - D. $25\text{ km/h}\cdot\text{s}$, north
 - E. $25\text{ km/h}\cdot\text{s}$, south
- ans: E
30. An object is moving on a circular path of radius π meters at a constant speed of 4.0 m/s . The time required for one revolution is:
- A. $2/\pi^2\text{ s}$
 - B. $\pi^2/2\text{ s}$
 - C. $\pi/2\text{ s}$
 - D. $\pi^2/4$
 - E. $2/\pi\text{ s}$
- ans: B
31. A particle moves at constant speed in a circular path. The instantaneous velocity and instantaneous acceleration vectors are:
- A. both tangent to the circular path
 - B. both perpendicular to the circular path
 - C. perpendicular to each other
 - D. opposite to each other
 - E. none of the above
- ans: C
32. A stone is tied to a string and whirled at constant speed in a horizontal circle. The speed is then doubled without changing the length of the string. Afterward the magnitude of the acceleration of the stone is:
- A. the same
 - B. twice as great
 - C. four times as great
 - D. half as great
 - E. one-fourth as great
- ans: C

33. Two objects are traveling around different circular orbits with constant speed. They both have the same acceleration but object A is traveling twice as fast as object B. The orbit radius for object A is _____ the orbit radius for object B.
- A. one-fourth
 - B. one-half
 - C. the same as
 - D. twice
 - E. four times
- ans: E
34. A stone is tied to a 0.50-m string and whirled at a constant speed of 4.0 m/s in a vertical circle. Its acceleration at the top of the circle is:
- A. 9.8 m/s^2 , up
 - B. 9.8 m/s^2 , down
 - C. 8.0 m/s^2 , down
 - D. 32 m/s^2 , up
 - E. 32 m/s^2 , down
- ans: E
35. A stone is tied to a 0.50-m string and whirled at a constant speed of 4.0 m/s in a vertical circle. Its acceleration at the bottom of the circle is:
- A. 9.8 m/s^2 , up
 - B. 9.8 m/s^2 , down
 - C. 8.0 m/s^2 , up
 - D. 32 m/s^2 , up
 - E. 32 m/s^2 , down
- ans: D
36. A car rounds a 20-m radius curve at 10 m/s. The magnitude of its acceleration is:
- A. 0
 - B. 0.20 m/s^2
 - C. 5.0 m/s^2
 - D. 40 m/s^2
 - E. 400 m/s^2
- ans: C
37. For a biological sample in a 1.0-m radius centrifuge to have a centripetal acceleration of $25g$ its speed must be:
- A. 11 m/s
 - B. 16 m/s
 - C. 50 m/s
 - D. 122 m/s
 - E. 245 m/s
- ans: B

38. A girl jogs around a horizontal circle with a constant speed. She travels one fourth of a revolution, a distance of 25 m along the circumference of the circle, in 5.0 s. The magnitude of her acceleration is:
- A. 0.31 m/s^2
 - B. 1.3 m/s^2
 - C. 1.6 m/s^2
 - D. 3.9 m/s^2
 - E. 6.3 m/s^2
- ans: C
39. A stone is tied to the end of a string and is swung with constant speed around a horizontal circle with a radius of 1.5 m. If it makes two complete revolutions each second, the magnitude of its acceleration is:
- A. 0.24 m/s^2
 - B. 2.4 m/s^2
 - C. 24 m/s^2
 - D. 240 m/s^2
 - E. 2400 m/s^2
- ans: D
40. A Ferris wheel with a radius of 8.0 m makes 1 revolution every 10 s. When a passenger is at the top, essentially a diameter above the ground, he releases a ball. How far from the point on the ground directly under the release point does the ball land?
- A. 0
 - B. 1.0 m
 - C. 8.0 m
 - D. 9.1 m
 - E. 16 m
- ans: D
41. A boat is able to move through still water at 20 m/s. It makes a round trip to a town 3.0 km upstream. If the river flows at 5 m/s, the time required for this round trip is:
- A. 120 s
 - B. 150 s
 - C. 200 s
 - D. 300 s
 - E. 320 s
- ans: E

42. A boat is traveling upstream at 14 km/h with respect to a river that is flowing at 6 km/h (with respect to the ground). A man runs directly across the boat, from one side to the other, at 6 km/h (with respect to the boat). The speed of the man with respect to the ground is:
- A. 10 km/h
 - B. 14 km/h
 - C. 18.5 km/h
 - D. 21 km/h
 - E. 26 km/h

ans: A

43. A ferry boat is sailing at 12 km/h 30° W of N with respect to a river that is flowing at 6.0 km/h
E. As observed from the shore, the ferry boat is sailing:
- A. 30° E of N
 - B. due N
 - C. 30° W of N
 - D. 45° E of N
 - E. none of these

ans: B

44. A boy wishes to row across a river in the shortest possible time. He can row at 2 m/s in still water and the river is flowing at 1 m/s. At what angle θ should he point the bow (front) of his boat?



- A. 30°
- B. 45°
- C. 60°
- D. 63°
- E. 90°

ans: E

45. A girl wishes to swim across a river to a point directly opposite as shown. She can swim at 2 m/s in still water and the river is flowing at 1 m/s. At what angle θ with respect to the line joining the starting and finishing points should she swim?

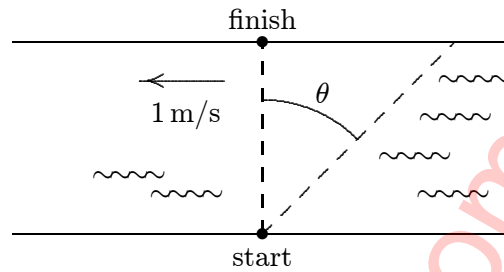

- A. 30°
 B. 45°
 C. 60°
 D. 63°
 E. 90°
 ans: A
46. A motor boat can travel at 10 km/h in still water. A river flows at 5 km/h west. A boater wishes to cross from the south bank to a point directly opposite on the north bank. At what angle must the boat be headed?
- A. 27° E of N
 B. 30° E of N
 C. 45° E of N
 D. 60° E of N
 E. depends on the width of the river
 ans: B
47. Two projectiles are in flight at the same time. The acceleration of one relative to the other:
- A. is always 9.8 m/s^2
 B. can be as large as 19.8 m/s^2
 C. can be horizontal
 D. is zero
 E. none of these
 ans: D

Chapter 5: FORCE AND MOTION — I

- An example of an inertial reference frame is:
 - any reference frame that is not accelerating
 - a frame attached to a particle on which there are no forces
 - any reference frame that is at rest
 - a reference frame attached to the center of the universe
 - a reference frame attached to Earthans: B
- An object moving at constant velocity in an inertial frame must:
 - have a net force on it
 - eventually stop due to gravity
 - not have any force of gravity on it
 - have zero net force on it
 - have no frictional force on itans: D
- In SI units a force is numerically equal to the _____, when the force is applied to it.
 - velocity of the standard kilogram
 - speed of the standard kilogram
 - velocity of any object
 - acceleration of the standard kilogram
 - acceleration of any objectans: D
- Which of the following quantities is NOT a vector?
 - Mass
 - Displacement
 - Weight
 - Acceleration
 - Forceans: A
- A newton is the force:
 - of gravity on a 1 kg body
 - of gravity on a 1 g body
 - that gives a 1 g body an acceleration of 1 cm/s^2
 - that gives a 1 kg body an acceleration of 1 m/s^2
 - that gives a 1 kg body an acceleration of 9.8 m/s^2ans: D

6. The unit of force called the newton is:
- A. $9.8 \text{ kg} \cdot \text{m}/\text{s}^2$
 - B. $1 \text{ kg} \cdot \text{m}/\text{s}^2$
 - C. defined by means of Newton's third law
 - D. 1 kg of mass
 - E. 1 kg of force

ans: B

7. A force of 1 N is:
- A. 1 kg/s
 - B. $1 \text{ kg} \cdot \text{m}/\text{s}$
 - C. $1 \text{ kg} \cdot \text{m}/\text{s}^2$
 - D. $1 \text{ kg} \cdot \text{m}^2/\text{s}$
 - E. $1 \text{ kg} \cdot \text{m}^2/\text{s}^2$

ans: C

8. The standard 1-kg mass is attached to a compressed spring and the spring is released. If the mass initially has an acceleration of $5.6 \text{ m}/\text{s}^2$, the force of the spring has a magnitude of:
- A. 2.8 N
 - B. 5.6 N
 - C. 11.2 N
 - D. 0
 - E. an undetermined amount

ans: B

9. Acceleration is always in the direction:
- A. of the displacement
 - B. of the initial velocity
 - C. of the final velocity
 - D. of the net force
 - E. opposite to the frictional force

ans: D

10. The term "mass" refers to the same physical concept as:
- A. weight
 - B. inertia
 - C. force
 - D. acceleration
 - C. volume

ans: B

11. The inertia of a body tends to cause the body to:
- A. speed up
 - B. slow down
 - C. resist any change in its motion
 - D. fall toward Earth
 - E. decelerate due to friction

ans: C

12. A heavy ball is suspended as shown. A quick jerk on the lower string will break that string but a slow pull on the lower string will break the upper string. The first result occurs because:

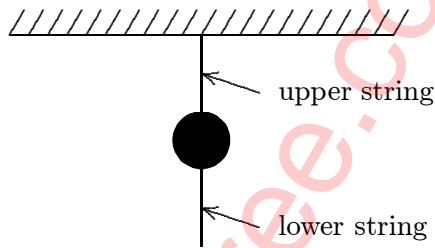

- A. the force is too small to move the ball
- B. action and reaction is operating
- C. the ball has inertia
- D. air friction holds the ball back
- E. the ball has too much energy

ans: C

13. When a certain force is applied to the standard kilogram its acceleration is 5.0 m/s^2 . When the same force is applied to another object its acceleration is one-fifth as much. The mass of the object is:

- A. 0.2 kg
- B. 0.5 kg
- C. 1.0 kg
- D. 5.0 kg
- E. 10 kg

ans: D

14. Mass differs from weight in that:

- A. all objects have weight but some lack mass
- B. weight is a force and mass is not
- C. the mass of an object is always more than its weight
- D. mass can be expressed only in the metric system
- E. there is no difference

ans: B

15. The mass of a body:
- A. is slightly different at different places on Earth
 - B. is a vector
 - C. is independent of the free-fall acceleration
 - D. is the same for all bodies of the same volume
 - E. can be measured most accurately on a spring scale
- ans: C
16. The mass and weight of a body:
- A. differ by a factor of 9.8
 - B. are identical
 - C. are the same physical quantities expressed in different units
 - D. are both a direct measure of the inertia of the body
 - E. have the same ratio as that of any other body placed at that location
- ans: E
17. An object placed on an equal-arm balance requires 12 kg to balance it. When placed on a spring scale, the scale reads 12 kg. Everything (balance, scale, set of weights and object) is now transported to the Moon where the free-fall acceleration is one-sixth that on Earth. The new readings of the balance and spring scale (respectively) are:
- A. 12 kg, 12 kg
 - B. 2 kg, 2 kg
 - C. 12 kg, 2 kg
 - D. 2 kg, 12 kg
 - E. 12 kg, 72 kg
- ans: C
18. Two objects, one having three times the mass of the other, are dropped from the same height in a vacuum. At the end of their fall, their velocities are equal because:
- A. anything falling in vacuum has constant velocity
 - B. all objects reach the same terminal velocity
 - C. the acceleration of the larger object is three times greater than that of the smaller object
 - D. the force of gravity is the same for both objects
 - E. none of the above
- ans: E
19. A feather and a lead ball are dropped from rest in vacuum on the Moon. The acceleration of the feather is:
- A. more than that of the lead ball
 - B. the same as that of the lead ball
 - C. less than that of the lead ball
 - D. 9.8 m/s^2
 - E. zero since it floats in a vacuum
- ans: B

20. The block shown moves with constant velocity on a horizontal surface. Two of the forces on it are shown. A frictional force exerted by the surface is the only other horizontal force on the block. The frictional force is:

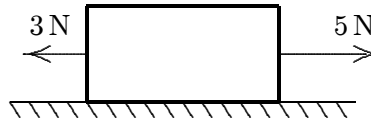

- A. 0
- B. 2 N, leftward
- C. 2 N, rightward
- D. slightly more than 2 N, leftward
- E. slightly less than 2 N, leftward

ans: B

21. Two forces, one with a magnitude of 3 N and the other with a magnitude of 5 N, are applied to an object. For which orientations of the forces shown in the diagrams is the magnitude of the acceleration of the object the least?

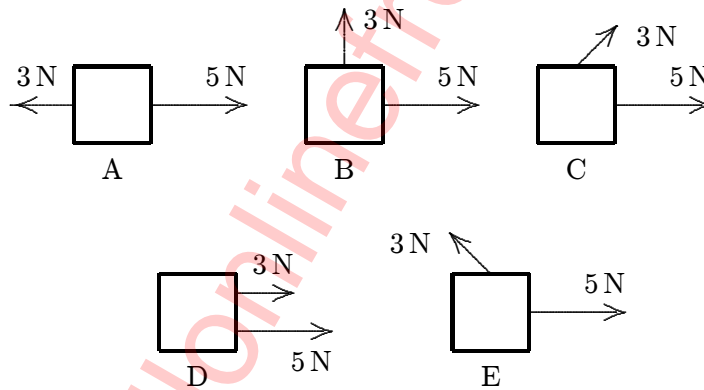

ans: A

22. A crate rests on a horizontal surface and a woman pulls on it with a 10-N force. Rank the situations shown below according to the magnitude of the normal force exerted by the surface on the crate, least to greatest.

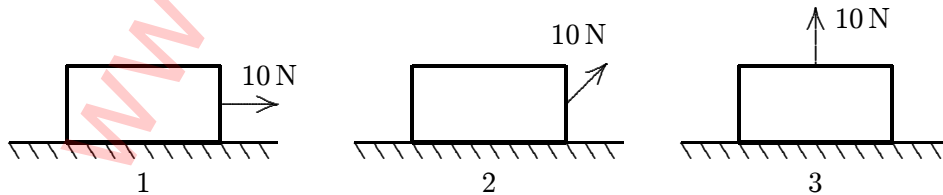

- A. 1, 2, 3
- B. 2, 1, 3
- C. 2, 3, 1
- D. 1, 3, 2
- E. 3, 2, 1

ans: E

23. A heavy wooden block is dragged by a force \vec{F} along a rough steel plate, as shown in the diagrams for two cases. The magnitude of the applied force \vec{F} is the same for both cases. The normal force in (ii), as compared with the normal force in (i) is:

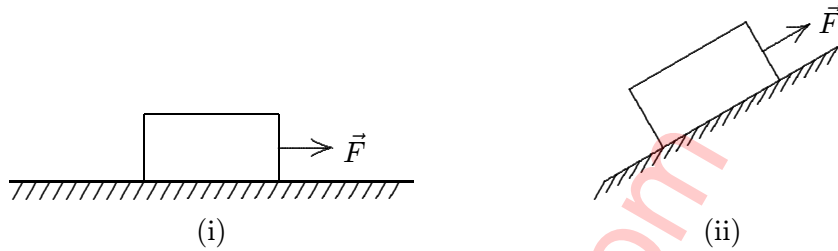

- A. the same
B. greater
C. less
D. less for some angles of the incline and greater for others
E. less or greater, depending on the magnitude of the applied force \vec{F} .
- ans: C
24. Equal forces \vec{F} act on isolated bodies A and B. The mass of B is three times that of A. The magnitude of the acceleration of A is:
- A. three times that of B
B. 1/3 that of B
C. the same as B
D. nine times that of B
E. 1/9 that of B
- ans: A
25. A car travels east at constant velocity. The net force on the car is:
- A. east
B. west
C. up
D. down
E. zero
- ans: E
26. A constant force of 8.0 N is exerted for 4.0 s on a 16-kg object initially at rest. The change in speed of this object will be:
- A. 0.5 m/s
B. 2 m/s
C. 4 m/s
D. 8 m/s
E. 32 m/s
- ans: B

27. A 6-kg object is moving south. A net force of 12 N north on it results in the object having an acceleration of:
- A. 2 m/s^2 , north
 - B. 2 m/s^2 , south
 - C. 6 m/s^2 , north
 - D. 18 m/s^2 , north
 - E. 18 m/s^2 , south
- ans: A
28. A 9000-N automobile is pushed along a level road by four students who apply a total forward force of 500 N. Neglecting friction, the acceleration of the automobile is:
- A. 0.055 m/s^2
 - B. 0.54 m/s^2
 - C. 1.8 m/s^2
 - D. 9.8 m/s^2
 - E. 18 m/s^2
- ans: B
29. An object rests on a horizontal frictionless surface. A horizontal force of magnitude F is applied. This force produces an acceleration:
- A. only if F is larger than the weight of the object
 - B. only while the object suddenly changes from rest to motion
 - C. always
 - D. only if the inertia of the object decreases
 - E. only if F is increasing
- ans: C
30. A 25-kg crate is pushed across a frictionless horizontal floor with a force of 20 N, directed 20° below the horizontal. The acceleration of the crate is:
- A. 0.27 m/s^2
 - B. 0.75 m/s^2
 - C. 0.80 m/s^2
 - D. 170 m/s^2
 - E. 470 m/s^2
- ans: B
31. A ball with a weight of 1.5 N is thrown at an angle of 30° above the horizontal with an initial speed of 12 m/s. At its highest point, the net force on the ball is:
- A. 9.8 N, 30° below horizontal
 - B. zero
 - C. 9.8 N, up
 - D. 9.8 N, down
 - E. 1.5 N, down
- ans: E

32. Two forces are applied to a 5.0-kg crate; one is 6.0 N to the north and the other is 8.0 N to the west. The magnitude of the acceleration of the crate is:
- A. 0.50 m/s^2
 - B. 2.0 m/s^2
 - C. 2.8 m/s^2
 - D. 10 m/s^2
 - E. 50 m/s^2
- ans: B

33. A 400-N steel ball is suspended by a light rope from the ceiling. The tension in the rope is:
- A. 400 N
 - B. 800 N
 - C. zero
 - D. 200 N
 - E. 560 N
- ans: A

34. A heavy steel ball B is suspended by a cord from a block of wood W. The entire system is dropped through the air. Neglecting air resistance, the tension in the cord is:
- A. zero
 - B. the difference in the masses of B and W
 - C. the difference in the weights of B and W
 - D. the weight of B
 - E. none of these
- ans: A

35. A circus performer of weight W is walking along a “high wire” as shown. The tension in the wire:

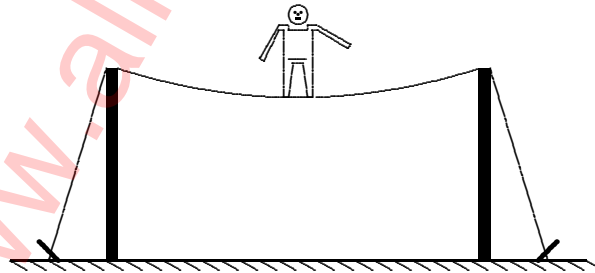

- A. is approximately W
 - B. is approximately $W/2$
 - C. is much less than W
 - D. is much more than W
 - E. depends on whether he stands on one foot or two feet
- ans: D

36. A 1000-kg elevator is rising and its speed is increasing at 3 m/s^2 . The tension force of the cable on the elevator is:
- A. 6800 N
 - B. 1000 N
 - C. 3000 N
 - D. 9800 N
 - E. 12800 N
- ans: E

- *37. A 5-kg block is suspended by a rope from the ceiling of an elevator as the elevator accelerates downward at 3.0 m/s^2 . The tension force of the rope on the block is:
- A. 15 N, up
 - B. 34 N, up
 - C. 34 N, down
 - D. 64 N, up
 - E. 64 N, down
- ans: B

38. A crane operator lowers a 16,000-N steel ball with a downward acceleration of 3 m/s^2 . The tension force of the cable is:
- A. 4900 N
 - B. 11,000 N
 - C. 16,000 N
 - D. 21,000 N
 - E. 48,000 N
- ans: B

39. A 1-N pendulum bob is held at an angle θ from the vertical by a 2-N horizontal force F as shown. The tension in the string supporting the pendulum bob (in newtons) is:

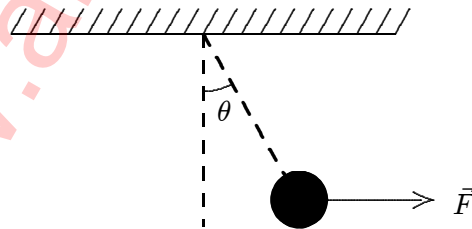

- A. $\cos \theta$
 - B. $2/\cos \theta$
 - C. $\sqrt{5}$
 - D. 1
 - E. none of these
- ans: C

40. A car moves horizontally with a constant acceleration of 3 m/s^2 . A ball is suspended by a string from the ceiling of the car. The ball does not swing, being at rest with respect to the car. What angle does the string make with the vertical?
- A. 17°
 - B. 35°
 - C. 52°
 - D. 73°
 - E. Cannot be found without knowing the length of the string
- ans: A
41. A man weighing 700 N is in an elevator that is accelerating upward at 4 m/s^2 . The force exerted on him by the elevator floor is:
- A. 71 N
 - B. 290 N
 - C. 410 N
 - D. 700 N
 - E. 990 N
- ans: E
42. You stand on a spring scale on the floor of an elevator. Of the following, the scale shows the highest reading when the elevator:
- A. moves upward with increasing speed
 - B. moves upward with decreasing speed
 - C. remains stationary
 - D. moves downward with increasing speed
 - E. moves downward at constant speed
- ans: A
43. You stand on a spring scale on the floor of an elevator. Of the following, the scale shows the highest reading when the elevator:
- A. moves downward with increasing speed
 - B. moves downward with decreasing speed
 - C. remains stationary
 - D. moves upward with decreasing speed
 - E. moves upward at constant speed
- ans: B
44. When a 25-kg crate is pushed across a frictionless horizontal floor with a force of 200 N , directed 20° below the horizontal, the magnitude of the normal force of the floor on the crate is:
- A. 25 N
 - B. 68 N
 - C. 180 N
 - D. 250 N
 - E. 310 N
- ans: E

45. A block slides down a frictionless plane that makes an angle of 30° with the horizontal. The acceleration of the block is:
- A. 980 cm/s^2
 - B. 566 cm/s^2
 - C. 849 cm/s^2
 - D. zero
 - E. 490 cm/s^2
- ans: E
46. A 25-N crate slides down a frictionless incline that is 25° above the horizontal. The magnitude of the normal force of the incline on the crate is:
- A. 11 N
 - B. 23 N
 - C. 25 N
 - D. 100 N
 - E. 220 N
- ans: B
47. A 25-N crate is held at rest on a frictionless incline by a force that is parallel to the incline. If the incline is 25° above the horizontal the magnitude of the applied force is:
- A. 4.1 N
 - B. 4.6 N
 - C. 8.9 N
 - D. 11 N
 - E. 23 N
- ans: D
48. A 25-N crate is held at rest on a frictionless incline by a force that is parallel to the incline. If the incline is 25° above the horizontal the magnitude of the normal force of the incline on the crate is:
- A. 4.1 N
 - B. 4.6 N
 - C. 8.9 N
 - D. 11 N
 - E. 23 N
- ans: E
49. A 32-N force, parallel to the incline, is required to push a certain crate at constant velocity up a frictionless incline that is 30° above the horizontal. The mass of the crate is:
- A. 3.3 kg
 - B. 3.8 kg
 - C. 5.7 kg
 - D. 6.5 kg
 - E. 160 kg
- ans: D

50. A sled is on an icy (frictionless) slope that is 30° above the horizontal. When a 40-N force, parallel to the incline and directed up the incline, is applied to the sled, the acceleration of the sled is 2.0 m/s^2 , down the incline. The mass of the sled is:
- A. 3.8 kg
 - B. 4.1 kg
 - C. 5.8 kg
 - D. 6.2 kg
 - E. 10 kg
- ans: E
51. When a 40-N force, parallel to the incline and directed up the incline, is applied to a crate on a frictionless incline that is 30° above the horizontal, the acceleration of the crate is 2.0 m/s^2 , up the incline. The mass of the crate is:
- A. 3.8 kg
 - B. 4.1 kg
 - C. 5.8 kg
 - D. 6.2 kg
 - E. 10 kg
- ans: C
52. The “reaction” force does not cancel the “action” force because:
- A. the action force is greater than the reaction force
 - B. they are on different bodies
 - C. they are in the same direction
 - D. the reaction force exists only after the action force is removed
 - E. the reaction force is greater than the action force
- ans: B
53. A book rests on a table, exerting a downward force on the table. The reaction to this force is:
- A. the force of Earth on the book
 - B. the force of the table on the book
 - C. the force of Earth on the table
 - D. the force of the book on Earth
 - E. the inertia of the book
- ans: B
54. A lead block is suspended from your hand by a string. The reaction to the force of gravity on the block is the force exerted by:
- A. the string on the block
 - B. the block on the string
 - C. the string on the hand
 - D. the hand on the string
 - E. the block on Earth
- ans: E

55. A 5-kg concrete block is lowered with a downward acceleration of 2.8 m/s^2 by means of a rope. The force of the block on the rope is:
- A. 14 N, up
 - B. 14 N, down
 - C. 35 N, up
 - D. 35 N, down
 - E. 49 N, up
- ans: D
56. A 90-kg man stands in an elevator that is moving up at a constant speed of 5.0 m/s . The force exerted by him on the floor is about:
- A. zero
 - B. 90 N
 - C. 880 N
 - D. 450 N
 - E. 49 N
- ans: C
57. A 90-kg man stands in an elevator that has a downward acceleration of 1.4 m/s^2 . The force exerted by him on the floor is about:
- A. zero
 - B. 90 N
 - C. 760 N
 - D. 880 N
 - E. 1010 N
- ans: C
58. A 5-kg concrete block is lowered with a downward acceleration of 2.8 m/s^2 by means of a rope. The force of the block on Earth is:
- A. 14 N, up
 - B. 14 N, down
 - C. 35 N, up
 - D. 35 N, down
 - E. 49 N, up
- ans: E

59. Two blocks are connected by a string and pulley as shown. Assuming that the string and pulley are massless, the magnitude of the acceleration of each block is:

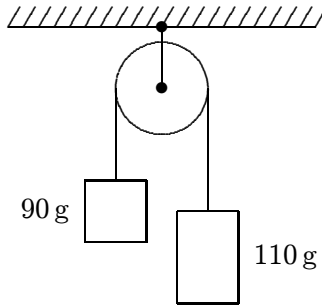

- A. 0.049 m/s^2
- B. 0.020 m/s^2
- C. 0.0098 m/s^2
- D. 0.54 m/s^2
- E. 0.98 m/s^2

ans: E

60. A 70-N block and a 35-N block are connected by a string as shown. If the pulley is massless and the surface is frictionless, the magnitude of the acceleration of the 35-N block is:

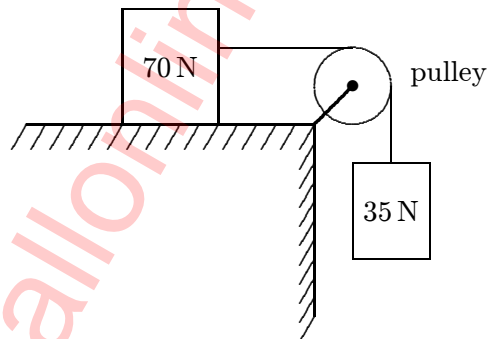

- A. 1.6 m/s^2
- B. 3.3 m/s^2
- C. 4.9 m/s^2
- D. 6.7 m/s^2
- E. 9.8 m/s^2

ans: B

61. A 13-N weight and a 12-N weight are connected by a massless string over a massless, frictionless pulley. The 13-N weight has a downward acceleration with magnitude equal to that of a freely falling body times:

A. 1
B. $1/12$
C. $1/13$
D. $1/25$
E. $13/25$

ans: D

62. A massless rope passes over a massless pulley suspended from the ceiling. A 4-kg block is attached to one end and a 5-kg block is attached to the other end. The acceleration of the 5-kg block is:

A. $g/4$
B. $5g/9$
C. $4g/9$
D. $g/5$
E. $g/9$

ans: E

63. Two blocks, weighing 250 N and 350 N, respectively, are connected by a string that passes over a massless pulley as shown. The tension in the string is:

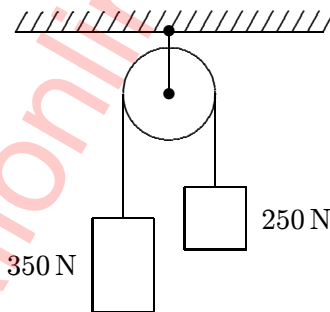

A. 210 N
B. 290 N
C. 410 N
D. 500 N
E. 4900 N

ans: B

64. Three books (X, Y, and Z) rest on a table. The weight of each book is indicated. The net force acting on book Y is:

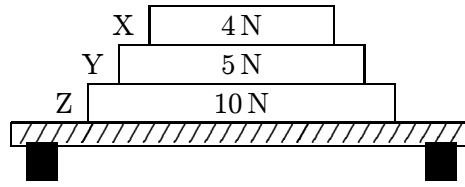

- A. 4 N down
- B. 5 N up
- C. 9 N down
- D. zero
- E. none of these

ans: D

65. Three books (X, Y, and Z) rest on a table. The weight of each book is indicated. The force of book Z on book Y is:

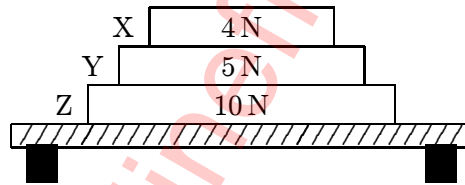

- A. 0
- B. 5 N
- C. 9 N
- D. 14 N
- E. 19 N

ans: C

66. Three blocks (A,B,C), each having mass M , are connected by strings as shown. Block C is pulled to the right by a force \vec{F} that causes the entire system to accelerate. Neglecting friction, the net force acting on block B is:

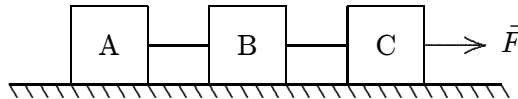

- A. zero
- B. $\vec{F}/3$
- C. $\vec{F}/2$
- D. $2\vec{F}/3$
- E. \vec{F}

ans: B

67. Two blocks with masses m and M are pushed along a horizontal frictionless surface by a horizontal applied force \vec{F} as shown. The magnitude of the force of either of these blocks on the other is:

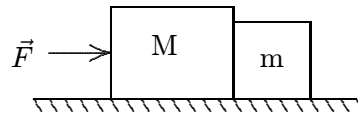

- A. $mF/(m + M)$
 B. mF/M
 C. $mF/(M - m)$
 D. $MF/(M + m)$
 E. MF/m

ans: A

68. Two blocks (A and B) are in contact on a horizontal frictionless surface. A 36-N constant force is applied to A as shown. The magnitude of the force of A on B is:

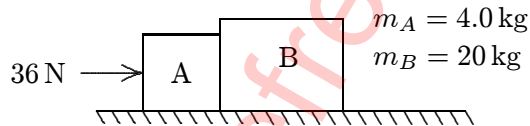

- A. 1.5 N
 B. 6.0 N
 C. 29 N
 D. 30 N
 E. 36 N

ans: D

69. A short 10-g string is used to pull a 50-g toy across a frictionless horizontal surface. If a 3.0×10^{-2} -N force is applied horizontally to the free end, the force of the string on the toy, at the other end, is:

- A. 0.15 N
 B. 6.0×10^{-3} N
 C. 2.5×10^{-2} N
 D. 3.0×10^{-2} N
 E. 3.5×10^{-2} N

ans: C

Chapter 6: FORCE AND MOTION — II

1. A brick slides on a horizontal surface. Which of the following will increase the magnitude of the frictional force on it?
- A. Putting a second brick on top
 - B. Decreasing the surface area of contact
 - C. Increasing the surface area of contact
 - D. Decreasing the mass of the brick
 - E. None of the above

ans: A

2. The coefficient of kinetic friction:
- A. is in the direction of the frictional force
 - B. is in the direction of the normal force
 - C. is the ratio of force to area
 - D. can have units of newtons
 - E. is none of the above

ans: E

3. When the brakes of an automobile are applied, the road exerts the greatest retarding force:
- A. while the wheels are sliding
 - B. just before the wheels start to slide
 - C. when the automobile is going fastest
 - D. when the acceleration is least
 - E. at the instant when the speed begins to change

ans: B

4. A forward horizontal force of 12 N is used to pull a 240-N crate at constant velocity across a horizontal floor. The coefficient of friction is:
- A. 0.5
 - B. 0.05
 - C. 2
 - D. 0.2
 - E. 20

ans: B

5. The speed of a 4.0-N hockey puck, sliding across a level ice surface, decreases at the rate of 0.61 m/s^2 . The coefficient of kinetic friction between the puck and ice is:
- A. 0.062
 - B. 0.41
 - C. 0.62
 - D. 1.2
 - E. 9.8

ans: A

6. A crate rests on a horizontal surface and a woman pulls on it with a 10-N force. No matter what the orientation of the force, the crate does not move. Rank the situations shown below according to the magnitude of the frictional force of the surface on the crate, least to greatest.

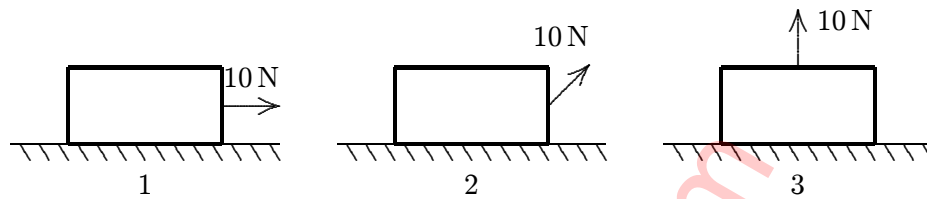

- A. 1, 2, 3
 B. 2, 1, 3
 C. 2, 3, 1
 D. 1, 3, 2
 E. 3, 2, 1

ans: E

7. A crate with a weight of 50 N rests on a horizontal surface. A person pulls horizontally on it with a force of 10 N and it does not move. To start it moving, a second person pulls vertically upward on the crate. If the coefficient of static friction is 0.4, what is the smallest vertical force for which the crate moves?

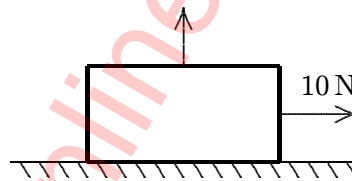

- A. 4 N
 B. 10 N
 C. 14 N
 D. 25 N
 E. 35 N

ans: D

8. A 40-N crate rests on a rough horizontal floor. A 12-N horizontal force is then applied to it. If the coefficients of friction are $\mu_s = 0.5$ and $\mu_k = 0.4$, the magnitude of the frictional force on the crate is:

- A. 8 N
 B. 12 N
 C. 16 N
 D. 20 N
 E. 40 N

ans: B

9. A 24-N horizontal force is applied to a 40-N block initially at rest on a rough horizontal surface. If the coefficients of friction are $\mu_s = 0.5$ and $\mu_k = 0.4$, the magnitude of the frictional force on the block is:
- A. 8 N
 - B. 12 N
 - C. 16 N
 - D. 20 N
 - E. 400 N

ans: C

10. A horizontal shove of at least 200 N is required to start moving a 800-N crate initially at rest on a horizontal floor. The coefficient of static friction is:
- A. 0.25
 - B. 0.125
 - C. 0.50
 - D. 4.00
 - E. none of these

ans: A

11. A force \vec{F} (larger than the largest possible force of static friction) is applied to the left to an object moving to the right on a horizontal surface. Then:
- A. the object must be moving at constant speed
 - B. \vec{F} and the friction force act in opposite directions
 - C. the object must be slowing down
 - D. the object must be speeding up
 - E. the object must come to rest and remain at rest

ans: C

12. A bureau rests on a rough horizontal surface ($\mu_s = 0.50$, $\mu_k = 0.40$). A constant horizontal force, just sufficient to start the bureau in motion, is then applied. The acceleration of the bureau is:
- A. 0
 - B. 0.98 m/s^2
 - C. 3.3 m/s^2
 - D. 4.5 m/s^2
 - E. 8.9 m/s^2

ans: B

13. A car is traveling at 15 m/s on a horizontal road. The brakes are applied and the car skids to a stop in 4.0 s. The coefficient of kinetic friction between the tires and road is:
- A. 0.38
 - B. 0.69
 - C. 0.76
 - D. 0.92
 - E. 1.11

ans: A

14. A boy pulls a wooden box along a rough horizontal floor at constant speed by means of a force \vec{P} as shown. In the diagram f is the magnitude of the force of friction, N is the magnitude of the normal force, and F_g is the magnitude of the force of gravity. Which of the following must be true?

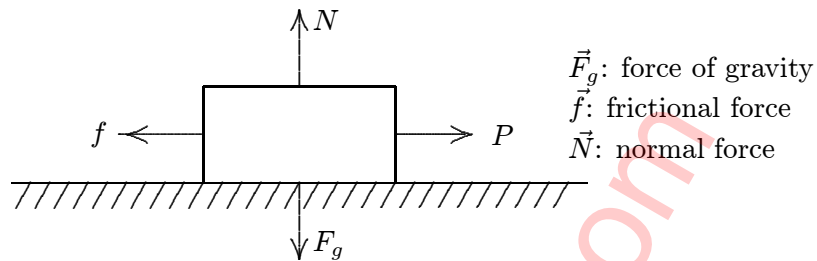

- A. $P = f$ and $N = F_g$
 B. $P = f$ and $N > F_g$
 C. $P > f$ and $N < F_g$
 D. $P > f$ and $N = F_g$
 E. none of these

ans: A

15. A boy pulls a wooden box along a rough horizontal floor at constant speed by means of a force \vec{P} as shown. In the diagram f is the magnitude of the force of friction, N is the magnitude of the normal force, and F_g is the magnitude of the force of gravity. Which of the following must be true?

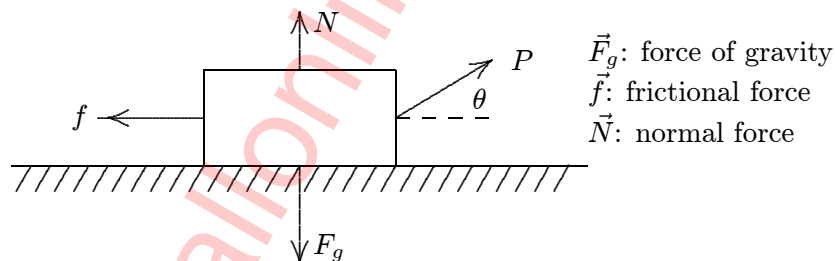

- A. $P = f$ and $N = F_g$
 B. $P = f$ and $N > F_g$
 C. $P > f$ and $N < F_g$
 D. $P > f$ and $N = F_g$
 E. none of these

ans: C

16. A 400-N block is dragged along a horizontal surface by an applied force \vec{F} as shown. The coefficient of kinetic friction is $\mu_k = 0.4$ and the block moves at constant velocity. The magnitude of \vec{F} is:

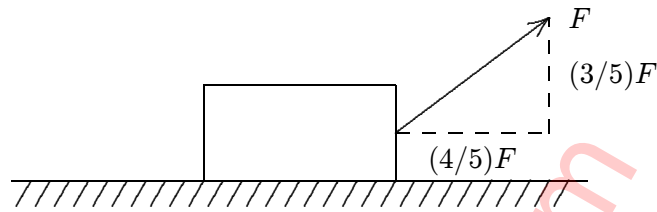

- A. 100 N
- B. 150 N
- C. 200 N
- D. 290 N
- E. 400 N

ans: B

17. A block of mass m is pulled at constant velocity along a rough horizontal floor by an applied force \vec{T} as shown. The magnitude of the frictional force is:

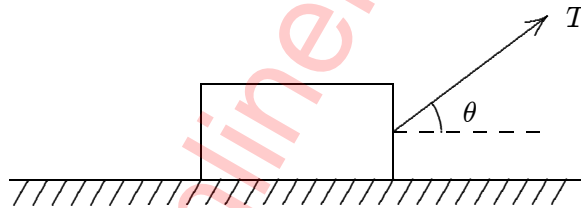

- A. $T \cos \theta$
- B. $T \sin \theta$
- C. zero
- D. mg
- E. $mg \cos \theta$

ans: A

18. A block of mass m is pulled along a rough horizontal floor by an applied force \vec{T} as shown. The vertical component of the force exerted on the block by the floor is:

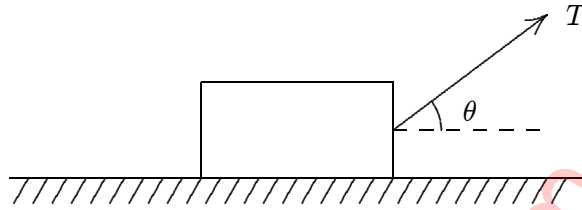

- A. mg
B. $mg - T \cos \theta$
C. $mg + T \cos \theta$
D. $mg - T \sin \theta$
E. $mg + T \sin \theta$
ans: D
19. A 12-kg crate rests on a horizontal surface and a boy pulls on it with a force that is 30° below the horizontal. If the coefficient of static friction is 0.40, the minimum magnitude force he needs to start the crate moving is:
A. 44 N
B. 47 N
C. 54 N
D. 56 N
E. 71 N
ans: E
20. A crate resting on a rough horizontal floor is to be moved horizontally. The coefficient of static friction is 0.40. To start the crate moving with the weakest possible applied force, in what direction should the force be applied?
A. Horizontal
B. 24° below the horizontal
C. 22° above the horizontal
D. 24° above the horizontal
E. 66° below the horizontal
ans: C
21. A 50-N force is applied to a crate on a horizontal rough floor, causing it to move horizontally. If the coefficient of kinetic friction is 0.50, in what direction should the force be applied to obtain the greatest acceleration?
A. Horizontal
B. 60° above the horizontal
C. 30° above the horizontal
D. 27° above the horizontal
E. 30° below the horizontal
ans: D

22. A professor holds an eraser against a vertical chalkboard by pushing horizontally on it. He pushes with a force that is much greater than is required to hold the eraser. The force of friction exerted by the board on the eraser increases if he:
- A. pushes with slightly greater force
 - B. pushes with slightly less force
 - C. stops pushing
 - D. pushes so his force is slightly downward but has the same magnitude
 - E. pushes so his force is slightly upward but has the same magnitude
- ans: D
23. A horizontal force of 12 N pushes a 0.5-kg book against a vertical wall. The book is initially at rest. If the coefficients of friction are $\mu_s = 0.6$ and $\mu_k = 0.8$ which of the following is true?
- A. The magnitude of the frictional force is 4.9 N
 - B. The magnitude of the frictional force is 7.2 N
 - C. The normal force is 4.9 N
 - D. The book will start moving and accelerate
 - E. If started moving downward, the book will decelerate
- ans: A
24. A horizontal force of 5.0 N pushes a 0.50-kg book against a vertical wall. The book is initially at rest. If the coefficients of friction are $\mu_s = 0.6$ and $\mu_k = 0.80$, the magnitude of the frictional force is:
- A. 0
 - B. 4.9 N
 - C. 3.0 N
 - D. 5.0 N
 - E. 4.0 N
- ans: E
25. A horizontal force of 12 N pushes a 0.50-kg book against a vertical wall. The book is initially at rest. If $\mu_s = 0.6$ and $\mu_k = 0.80$, the acceleration of the book in m/s^2 is:
- A. 0
 - B. 9.4 m/s^2
 - C. 9.8 m/s^2
 - D. 14.4 m/s^2
 - E. 19.2 m/s^2
- ans: A
26. A horizontal force of 5.0 N pushes a 0.50-kg block against a vertical wall. The block is initially at rest. If $\mu_s = 0.60$ and $\mu_k = 0.80$, the acceleration of the block in m/s^2 is:
- A. 0
 - B. 1.8
 - C. 6.0
 - D. 8.0
 - E. 9.8
- ans: B

27. A heavy wooden block is dragged by a force \vec{F} along a rough steel plate, as shown below for two possible situations. The magnitude of \vec{F} is the same for the two situations. The magnitude of the frictional force in (ii), as compared with that in (i) is:

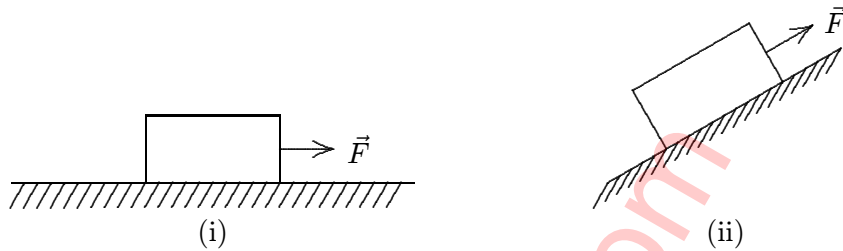

- A. the same
 B. greater
 C. less
 D. less for some angles and greater for others
 E. can be less or greater, depending on the magnitude of the applied force.

ans: C

28. A block is first placed on its long side and then on its short side on the same inclined plane, as shown. The block slides down the plane on its short side but remains at rest on its long side. A possible explanation is:

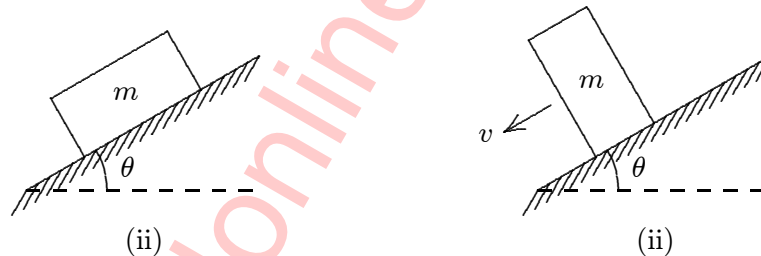

- A. the short side is smoother
 B. the frictional force is less because the contact area is less
 C. the center of gravity is higher in the second case
 D. the normal force is less in the second case
 E. the force of gravity is more nearly down the plane in the second case

ans: A

29. A box rests on a rough board 10 meters long. When one end of the board is slowly raised to a height of 6 meters above the other end, the box begins to slide. The coefficient of static friction is:

- A. 0.8
 B. 0.25
 C. 0.4
 D. 0.6
 E. 0.75

ans: E

30. A block is placed on a rough wooden plane. It is found that when the plane is tilted 30° to the horizontal, the block will slide down at constant speed. The coefficient of kinetic friction of the block with the plane is:
- A. 0.500
 - B. 0.577
 - C. 1.73
 - D. 0.866
 - E. 4.90
- ans: B
31. A crate is sliding down an incline that is 35° above the horizontal. If the coefficient of kinetic friction is 0.40, the acceleration of the crate is:
- A. 0
 - B. 2.4 m/s^2
 - C. 5.8 m/s^2
 - D. 8.8 m/s^2
 - E. 10.3 m/s^2
- ans: B
32. A 5.0-kg crate is resting on a horizontal plank. The coefficient of static friction is 0.50 and the coefficient of kinetic friction is 0.40. After one end of the plank is raised so the plank makes an angle of 25° with the horizontal, the force of friction is:
- A. 0
 - B. 18 N
 - C. 21 N
 - D. 22 N
 - E. 44 N
- ans: C
33. A 5.0-kg crate is resting on a horizontal plank. The coefficient of static friction is 0.50 and the coefficient of kinetic friction is 0.40. After one end of the plank is raised so the plank makes an angle of 30° with the horizontal, the force of friction is:
- A. 0
 - B. 18 N
 - C. 21 N
 - D. 22 N
 - E. 44 N
- ans: B

34. A 5.0-kg crate is on an incline that makes an angle of 30° with the horizontal. If the coefficient of static friction is 0.50, the minimum force that can be applied parallel to the plane to hold the crate at rest is:
- 0
 - 3.3 N
 - 30 N
 - 46 N
 - 55 N

ans: B

35. A 5.0-kg crate is on an incline that makes an angle of 30° with the horizontal. If the coefficient of static friction is 0.5, the maximum force that can be applied parallel to the plane without moving the crate is:
- 0
 - 3.3 N
 - 30 N
 - 46 N
 - 55 N

ans: D

36. Block A, with mass m_A , is initially at rest on a horizontal floor. Block B, with mass m_B , is initially at rest on the horizontal top surface of A. The coefficient of static friction between the two blocks is μ_s . Block A is pulled with a horizontal force. It begins to slide out from under B if the force is greater than:
- $m_A g$
 - $m_B g$
 - $\mu_s m_A g$
 - $\mu_s m_B g$
 - $\mu_s (m_A + m_B) g$

ans: E

37. The system shown remains at rest. Each block weighs 20 N. The force of friction on the upper block is:

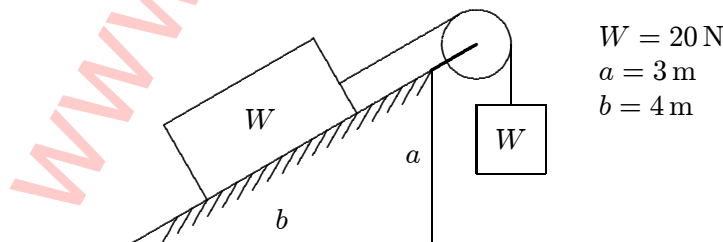

$$W = 20 \text{ N}$$

$$a = 3 \text{ m}$$

$$b = 4 \text{ m}$$

- 4 N
- 8 N
- 12 N
- 16 N
- 20 N

ans: B

38. Block A, with a mass of 50 kg, rests on a horizontal table top. The coefficient of static friction is 0.40. A horizontal string is attached to A and passes over a massless, frictionless pulley as shown. The smallest mass m_B of block B, attached to the dangling end, that will start A moving when it is attached to the other end of the string is:

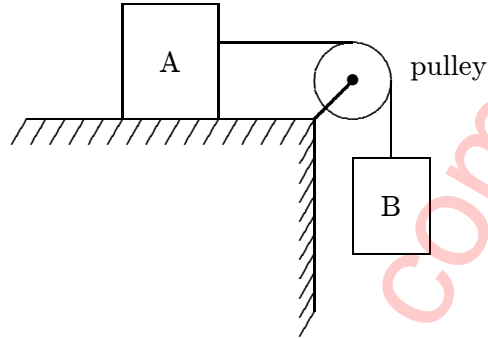

- A. 20 kg
- B. 30 kg
- C. 40 kg
- D. 50 kg
- E. 70 kg

ans: A

39. Block A, with a mass of 10 kg, rests on a 35° incline. The coefficient of static friction is 0.40. An attached string is parallel to the incline and passes over a massless, frictionless pulley at the top. The largest mass m_B of block B, attached to the dangling end, for which A begins to slide down the incline is:

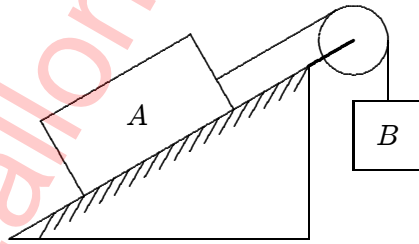

- A. 2.5 kg
- B. 3.5 kg
- C. 5.9 kg
- D. 9.0 kg
- E. 10.5 kg

ans: A

40. Block A, with a mass of 10 kg, rests on a 35° incline. The coefficient of static friction is 0.40. An attached string is parallel to the incline and passes over a massless, frictionless pulley at the top. The largest mass m_B , attached to the dangling end, for which A remains at rest is:

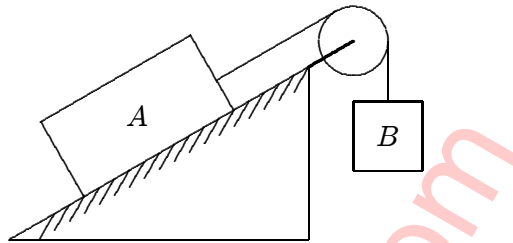

- A. 2.5 kg
 B. 3.5 kg
 C. 5.9 kg
 D. 9.0 kg
 E. 10.5 kg
 ans: D

41. Block A, with a mass of 10 kg, rests on a 30° incline. The coefficient of kinetic friction is 0.20. The attached string is parallel to the incline and passes over a massless, frictionless pulley at the top. Block B, with a mass of 8.0 kg, is attached to the dangling end of the string. The acceleration of B is:

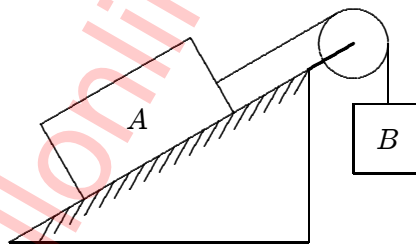

- A. 0.69 m/s^2 , up the plane
 B. 0.69 m/s^2 , down the plane
 C. 2.6 m/s^2 , up the plane
 D. 2.6 m/s^2 , down the plane
 E. 0
 ans: B

42. Block A, with a mass of 10 kg, rests on a 30° incline. The coefficient of kinetic friction is 0.20. The attached string is parallel to the incline and passes over a massless, frictionless pulley at the top. Block B, with a mass of 3.0 kg, is attached to the dangling end of the string. The acceleration of B is:

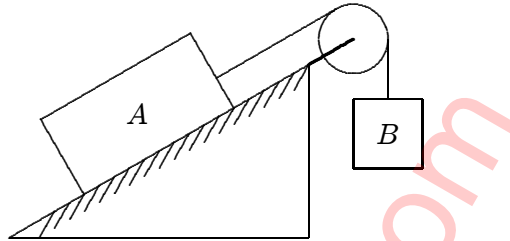

- A. 0.20 m/s^2 , up
B. 0.20 m/s^2 , down
C. 2.8 m/s^2 , up
D. 2.8 m/s^2 , down
E. 0
ans: A
43. A 1000-kg airplane moves in straight flight at constant speed. The force of air friction is 1800 N. The net force on the plane is:
A. zero
B. 11800 N
C. 1800 N
D. 9800 N
E. none of these
ans: A
44. Why do raindrops fall with constant speed during the later stages of their descent?
A. The gravitational force is the same for all drops
B. Air resistance just balances the force of gravity
C. The drops all fall from the same height
D. The force of gravity is negligible for objects as small as raindrops
E. Gravity cannot increase the speed of a falling object to more than 9.8 m/s
ans: B
45. A ball is thrown downward from the edge of a cliff with an initial speed that is three times the terminal speed. Initially its acceleration is
A. upward and greater than g
B. upward and less than g
C. downward and greater than g
D. downward and less than g
E. downward and equal to g
ans: A

46. A ball is thrown upward into the air with a speed that is greater than terminal speed. On the way up it slows down and, after its speed equals the terminal speed but before it gets to the top of its trajectory:
- A. its speed is constant
 - B. it continues to slow down
 - C. it speeds up
 - D. its motion becomes jerky
 - E. none of the above
- ans: B
47. A ball is thrown upward into the air with a speed that is greater than terminal speed. It lands at the place where it was thrown. During its flight the force of air resistance is the greatest:
- A. just after it is thrown
 - B. halfway up
 - C. at the top of its trajectory
 - D. halfway down
 - E. just before it lands.
- ans: A
48. Uniform circular motion is the direct consequence of:
- A. Newton's third law
 - B. a force that is always tangent to the path
 - C. an acceleration tangent to the path
 - D. a force of constant magnitude that is always directed away from the same fixed point
 - E. a force of constant magnitude that is always directed toward the same fixed point
- ans: E
49. An object moving in a circle at constant speed:
- A. must have only one force acting on it
 - B. is not accelerating
 - C. is held to its path by centrifugal force
 - D. has an acceleration of constant magnitude
 - E. has an acceleration that is tangent to the circle
- ans: D
50. An object of mass m and another object of mass $2m$ are each forced to move along a circle of radius 1.0 m at a constant speed of 1.0 m/s. The magnitudes of their accelerations are:
- A. equal
 - B. in the ratio of $\sqrt{2} : 1$
 - C. in the ratio of 2 : 1
 - D. in the ratio of 4 : 1
 - E. zero
- ans: A

51. The magnitude of the force required to cause a 0.04-kg object to move at 0.6 m/s in a circle of radius 1.0 m is:
- A. 2.4×10^{-2} N
 - B. 1.4×10^{-2} N
 - C. $1.4\pi \times 10^{-2}$ N
 - D. $2.4\pi^2 \times 10^{-2}$ N
 - E. 3.13 N
- ans: B

52. A 0.2-kg stone is attached to a string and swung in a circle of radius 0.6 m on a horizontal and frictionless surface. If the stone makes 150 revolutions per minute, the tension force of the string on the stone is:
- A. 0.03 N
 - B. 0.2 N
 - C. 0.9 N
 - D. 1.96 N
 - E. 30 N
- ans: E

53. Which of the following five graphs is correct for a particle moving in a circle of radius r at a constant speed of 10 m/s?

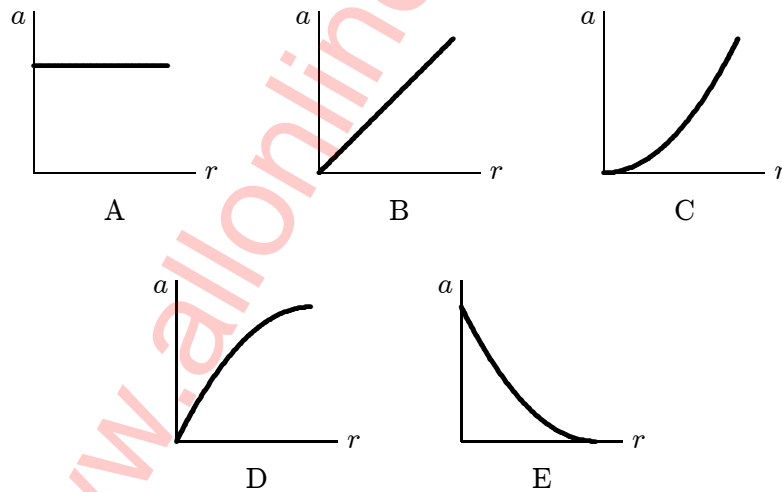

ans: E

54. An object moves around a circle. If the radius is doubled keeping the speed the same then the magnitude of the centripetal force must be:
- A. twice as great
 - B. half as great
 - C. four times as great
 - D. one-fourth as great
 - E. the same
- ans: B

55. An object moves in a circle. If the mass is tripled, the speed halved, and the radius unchanged, then the magnitude of the centripetal force must be multiplied by a factor of:
- A. $3/2$
 - B. $3/4$
 - C. $9/4$
 - D. 6
 - E. 12
- ans: B
56. If a satellite moves above Earth's atmosphere in a circular orbit with constant speed, then:
- A. its acceleration and velocity are always in the same direction
 - B. the net force on it is zero
 - C. its velocity is constant
 - D. it will fall back to Earth when its fuel is used up
 - E. its acceleration is toward the Earth
- ans: E
57. A 800-N passenger in a car presses against the car door with a 200 N force when the car makes a left turn at 13 m/s. The (faulty) door will pop open under a force of 800 N. Of the following, the least speed for which the passenger is thrown out of the car is:
- A. 14 m/s
 - B. 19 m/s
 - C. 20 m/s
 - D. 26 m/s
 - E. 54 m/s
- ans: D
58. If a certain car, going with speed v_1 , rounds a level curve with a radius R_1 , it is just on the verge of skidding. If its speed is now doubled, the radius of the tightest curve on the same road that it can round without skidding is:
- A. $2R_1$
 - B. $4R_1$
 - C. $R_1/2$
 - D. $R_1/4$
 - E. R_1
- ans: B
59. An automobile moves on a level horizontal road in a circle of radius 30 m. The coefficient of friction between tires and road is 0.50. The maximum speed with which this car can round this curve is:
- A. 3.0 m/s
 - B. 4.9 m/s
 - C. 9.8 m/s
 - D. 12 m/s
 - E. 13 m/s
- ans: D

60. The driver of a 1000-kg car tries to turn through a circle of radius 100 m on an unbanked curve at a speed of 10 m/s. The actual frictional force between the tires and slippery road has a magnitude of 900 N. The car:
- slides into the inside of the curve
 - makes the turn
 - slows down due to the frictional force
 - makes the turn only if it goes faster
 - slides off to the outside of the curve

ans: E

61. A car rounds a 75-m radius curve at a constant speed of 18 m/s. A ball is suspended by a string from the ceiling the car and moves with the car. The angle between the string and the vertical is:
- 0
 - 1.4°
 - 24°
 - 90°
 - cannot be found without knowing the mass of the ball

ans: C

62. A giant wheel, having a diameter of 40 m, is fitted with a cage and platform on which a man of mass m stands. The wheel is rotated in a vertical plane at such a speed that the force exerted by the man on the platform is equal to his weight when the cage is at X, as shown. The net force on the man at point X is:

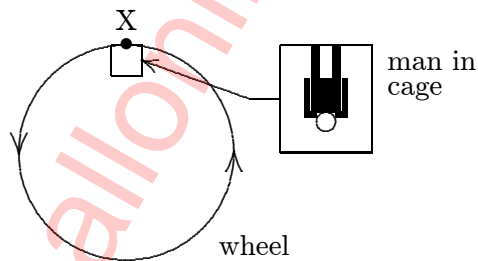

- zero
- mg , down
- mg , up
- $2mg$, down
- $2mg$, up

ans: D

63. A giant wheel, 40 m in diameter, is fitted with a cage and platform on which a man can stand. The wheel rotates at such a speed that when the cage is at X (as shown) the force exerted by the man on the platform is equal to his weight. The speed of the man is:

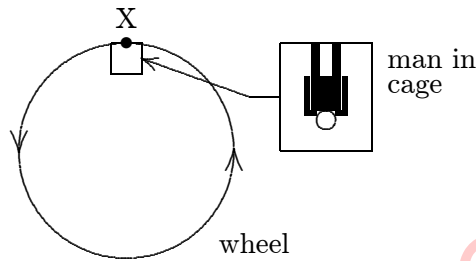

- A. 14 m/s
 B. 20 m/s
 C. 28 m/s
 D. 80 m/s
 E. 120 m/s

ans: B

64. A person riding a Ferris wheel is strapped into her seat by a seat belt. The wheel is spun so that the centripetal acceleration is g . Select the correct combination of forces that act on her when she is at the top. In the table F_g = force of gravity, down; F_b = seat belt force, down; and F_s = seat force, up.

	F_g	F_b	F_s
A.	0	mg	0
B.	mg	0	0
C.	0	0	mg
D.	mg	mg	0
E.	mg	0	mg

ans: B

65. One end of a 1.0-m long string is fixed, the other end is attached to a 2.0-kg stone. The stone swings in a vertical circle, passing the bottom point at 4.0 m/s. The tension force of the string at this point is about:

- A. 0
 B. 12 N
 C. 20 N
 D. 32 N
 E. 52 N

ans: E

66. One end of a 1.0-m string is fixed, the other end is attached to a 2.0-kg stone. The stone swings in a vertical circle, passing the top point at 4.0 m/s. The tension force of the string (in newtons) at this point is about:
- A. 0
 - B. 12
 - C. 20
 - D. 32
 - E. 52

ans: B

67. A coin is placed on a horizontal phonograph turntable. Let N be the magnitude of the normal force exerted by the turntable on the coin, f be the magnitude of the frictional force exerted by the turntable on the coin, and $f_{s, \max}$ be the maximum possible force of static friction. The speed of the turntable is increased in small steps. If the coin does not slide, then
- A. N increases, f increases, and $f_{s, \max}$ stays the same
 - B. N increases, f increases, and $f_{s, \max}$ increases
 - C. f increases and both N and $f_{s, \max}$ stay the same
 - D. N , f , and $f_{s, \max}$ all stay the same
 - E. N , f , and $f_{s, \max}$ all increase

ans: C

68. The iron ball shown is being swung in a vertical circle at the end of a 0.7-m long string. How slowly can the ball go through its top position without having the string go slack?



- A. 1.3 m/s
- B. 2.6 m/s
- C. 3.9 m/s
- D. 6.9 m/s
- E. 9.8 m/s

ans: B

69. A block is suspended by a rope from the ceiling of a car. When the car rounds a 45-m radius horizontal curve at 22 m/s (about 50 mph), what angle does the rope make with the vertical?
- A. 0
 - B. 25°
 - C. 48°
 - D. 65°
 - E. 90°

ans: C

70. Circular freeway entrance and exit ramps are commonly banked to handle a car moving at 13 m/s. To design a similar ramp for 26 m/s one should:
- A. increase radius by factor of 2
 - B. decrease radius by factor of 2
 - C. increase radius by factor of 4
 - D. decrease radius by factor of 4
 - E. increase radius by factor of $\sqrt{2}$
- ans: C

71. At what angle should the roadway on a curve with a 50 m radius be banked to allow cars to negotiate the curve at 12 m/s even if the roadway is icy (and the frictional force is zero)?
- A. 0
 - B. 16°
 - C. 18°
 - D. 35°
 - E. 73°
- ans: B

www.allonlinefree.com

Chapter 7: KINETIC ENERGY AND WORK

- Which of the following is NOT a correct unit for work?
 - erg
 - ft·lb
 - watt
 - newton·meter
 - jouleans: C
- Which of the following groups does NOT contain a scalar quantity?
 - velocity, force, power
 - displacement, acceleration, force
 - acceleration, speed, work
 - energy, work, distance
 - pressure, weight, timeans: B
- A boy holds a 40-N weight at arm's length for 10 s. His arm is 1.5 m above the ground. The work done by the force of the boy on the weight while he is holding it is:
 - 0
 - 6.1 J
 - 40 J
 - 60 J
 - 90 Jans: A
- A crate moves 10 m to the right on a horizontal surface as a woman pulls on it with a 10-N force. Rank the situations shown below according to the work done by her force, least to greatest.

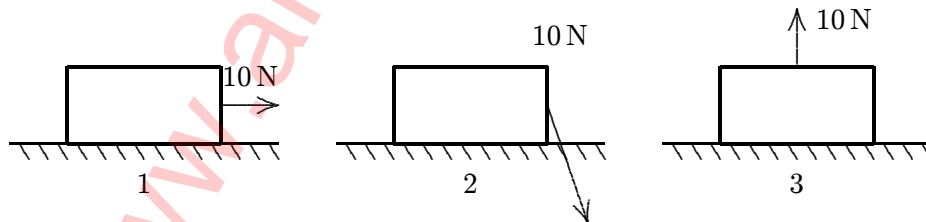

- 1, 2, 3
 - 2, 1, 3
 - 2, 3, 1
 - 1, 3, 2
 - 3, 2, 1
- ans: E

5. An object moves in a circle at constant speed. The work done by the centripetal force is zero because:
- A. the displacement for each revolution is zero
 - B. the average force for each revolution is zero
 - C. there is no friction
 - D. the magnitude of the acceleration is zero
 - E. the centripetal force is perpendicular to the velocity
- ans: E
6. An object of mass 1 g is whirled in a horizontal circle of radius 0.5 m at a constant speed of 2 m/s. The work done on the object during one revolution is:
- A. 0
 - B. 1 J
 - C. 2 J
 - D. 4 J
 - E. 16 J
- ans: A
7. The work done by gravity during the descent of a projectile:
- A. is positive
 - B. is negative
 - C. is zero
 - D. depends for its sign on the direction of the y axis
 - E. depends for its sign on the direction of both the x and y axes
- ans: A
8. A baseball is hit high into the upper bleachers of left field. Over its entire flight the work done by gravity and the work done by air resistance, respectively, are:
- A. positive; positive
 - B. positive; negative
 - C. negative; positive
 - D. negative; negative
 - E. unknown since vital information is lacking
- ans: D
9. A line drive to the shortstop is caught at the same height as it was originally hit. Over its entire flight the work done by gravity and the work done by air resistance, respectively, are:
- A. zero; positive
 - B. zero; negative
 - C. positive; negative
 - D. negative; positive
 - E. negative; negative
- ans: B

10. A 2-kg object is moving at 3 m/s. A 4-N force is applied in the direction of motion and then removed after the object has traveled an additional 5 m. The work done by this force is:
- A. 12 J
 - B. 15 J
 - C. 18 J
 - D. 20 J
 - E. 38 J
- ans: D
11. A sledge (including load) weighs 5000 N. It is pulled on level snow by a dog team exerting a horizontal force on it. The coefficient of kinetic friction between sledge and snow is 0.05. How much work is done by the dog team pulling the sledge 1000 m at constant speed?
- A. 2.5×10^4 J
 - B. 2.5×10^5 J
 - C. 5.0×10^5 J
 - D. 2.5×10^6 J
 - E. 5.0×10^6 J
- ans: B
12. Camping equipment weighing 6000 N is pulled across a frozen lake by means of a horizontal rope. The coefficient of kinetic friction is 0.05. The work done by the campers in pulling the equipment 1000 m at constant velocity is:
- A. 3.1×10^4 J
 - B. 1.5×10^5 J
 - C. 3.0×10^5 J
 - D. 2.9×10^6 J
 - E. 6.0×10^6 J
- ans: C
13. Camping equipment weighing 6000 N is pulled across a frozen lake by means of a horizontal rope. The coefficient of kinetic friction is 0.05. How much work is done by the campers in pulling the equipment 1000 m if its speed is increasing at the constant rate of 0.20 m/s^2 ?
- A. -1.2×10^6 J
 - B. 1.8×10^5 J
 - C. 3.0×10^5 J
 - D. 4.2×10^5 J
 - E. 1.2×10^6 J
- ans: D
14. A 1-kg block is lifted vertically 1 m by a boy. The work done by the boy is about:
- A. 1 ft · lb
 - B. 1 J
 - C. 10 J
 - D. 0.1 J
 - E. zero
- ans: C

15. A 0.50-kg object moves in a horizontal circular track with a radius of 2.5 m. An external force of 3.0 N, always tangent to the track, causes the object to speed up as it goes around. The work done by the external force as the mass makes one revolution is:
- A. 24 J
 - B. 47 J
 - C. 59 J
 - D. 94 J
 - E. 120 J
- ans: B

16. A man pulls a 100-N crate up a frictionless 30° slope 5 m high, as shown. Assuming that the crate moves at constant speed, the work done by the man is:

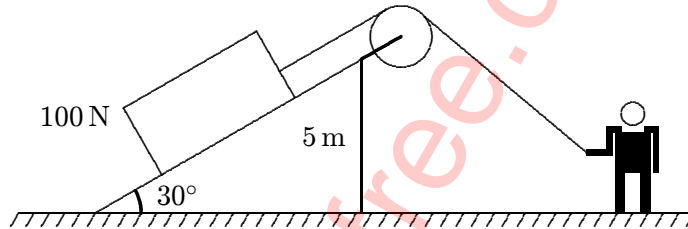

- A. -500 J
 - B. -250 J
 - C. 0
 - D. 250 J
 - E. 500 J
- ans: E
17. A man pushes an 80-N crate a distance of 5.0 m upward along a frictionless slope that makes an angle of 30° with the horizontal. His force is parallel to the slope. If the speed of the crate decreases at a rate of 1.5 m/s^2 , then the work done by the man is:
- A. -200 J
 - B. 61 J
 - C. 140 J
 - D. 200 J
 - E. 260 J
- ans: C
18. A man pushes an 80-N crate a distance of 5.0 m upward along a frictionless slope that makes an angle of 30° with the horizontal. The force he exerts is parallel to the slope. If the speed of the crate is constant, then the work done by the man is:
- A. -200 J
 - B. 61 J
 - C. 140 J
 - D. 200 J
 - E. 260 J
- ans: D

19. An 80-N crate slides with constant speed a distance of 5.0 m downward along a rough slope that makes an angle of 30° with the horizontal. The work done by the force of gravity is:
- A. -400 J
 - B. -200 J
 - C. -69 J
 - D. 200 J
 - E. 400 J
- ans: D
20. A man pulls a sled along a rough horizontal surface by applying a constant force \vec{F} at an angle θ above the horizontal. In pulling the sled a horizontal distance d , the work done by the man is:
- A. Fd
 - B. $Fd \cos \theta$
 - C. $Fd \sin \theta$
 - D. $Fd / \cos \theta$
 - E. $Fd / \sin \theta$
- ans: B
21. A man wishes to pull a crate 15 m across a rough floor by exerting a force of 100 N. The coefficient of kinetic friction is 0.25. For the man to do the least work, the angle between the force and the horizontal should be:
- A. 0
 - B. 14°
 - C. 43°
 - D. 66°
 - E. 76°
- ans: A
22. A particle moves 5 m in the positive x direction while being acted upon by a constant force $\vec{F} = (4 \text{ N})\hat{i} + (2 \text{ N})\hat{j} - (4 \text{ N})\hat{k}$. The work done on the particle by this force is:
- A. 20 J
 - B. 10 J
 - C. -20 J
 - D. 30 J
 - E. is impossible to calculate without knowing other forces
- ans: A
23. A block is attached to the end of an ideal spring and moved from coordinate x_i to coordinate x_f . The relaxed position is at $x = 0$. The work done by spring is positive if:
- A. $x_i = 2$ cm and $x_f = 4$ cm
 - B. $x_i = -2$ cm and $x_f = 4$ cm
 - C. $x_i = -2$ cm and $x_f = -4$ cm
 - D. $x_i = 2$ cm and $x_f = -4$ cm
 - E. $x_i = -4$ cm and $x_f = -2$ cm
- ans: E

24. An ideal spring, with a pointer attached to its end, hangs next to a scale. With a 100-N weight attached, the pointer indicates “40” on the scale as shown. Using a 200-N weight instead results in “60” on the scale. Using an unknown weight X instead results in “30” on the scale. The weight of X is:

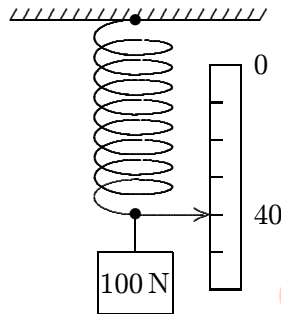

- A. 10 N
- B. 20 N
- C. 30 N
- D. 40 N
- E. 50 N

ans: E

25. Three identical ideal springs (X,Y,Z) are arranged as shown. When a 4.0-kg mass is hung on X, the mass descends 3.0 cm. When a 6.0-kg mass is hung on Y, the mass descends:

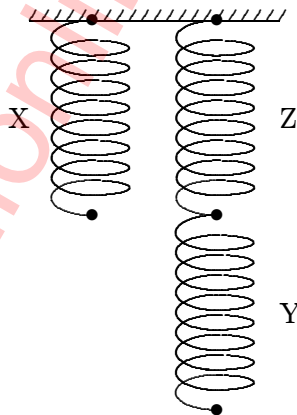

- A. 2.0 cm
- B. 4.0 cm
- C. 4.5 cm
- D. 6.0 cm
- E. 9.0 cm

ans: E

26. When a certain rubber band is stretched a distance x , it exerts a restoring force of magnitude $F = Ax$, where A is a constant. The work done by a person in stretching this rubber band from $x = 0$ to $x = L$, beginning and ending at rest, is:
- A. AL^2
 - B. $A + 2L$
 - C. $A + 2L^2$
 - D. A/L
 - E. $AL^2/2$
- ans: E
27. When a certain rubber band is stretched a distance x , it exerts a restoring force of magnitude $F = ax + bx^2$, where a and b are constants. The work done in stretching this rubber band from $x = 0$ to $x = L$ is:
- A. $aL^2 + bLx^3$
 - B. $aL + 2bL^2$
 - C. $a + 2bL$
 - D. bL
 - E. $aL^2/2 + bL^3/3$
- ans: E
28. An ideal spring is hung vertically from the ceiling. When a 2.0-kg mass hangs at rest from it the spring is extended 6.0 cm from its relaxed length. A downward external force is now applied to the mass to extend the spring an additional 10 cm. While the spring is being extended by the force, the work done by the spring is:
- A. -3.6 J
 - B. -3.3 J
 - C. -3.4×10^{-5} J
 - D. 3.3 J
 - E. 3.6 J
- ans: A
29. An ideal spring is hung vertically from the ceiling. When a 2.0-kg block hangs at rest from it the spring is extended 6.0 cm from its relaxed length. A upward external force is then applied to the block to move it upward a distance of 16 cm. While the block is moving upward the work done by the spring is:
- A. -1.0 J
 - B. -0.52 J
 - C. -0.26 J
 - D. 0.52 J
 - E. 1.0 J
- ans: A

30. Which of the following bodies has the largest kinetic energy?
- A. Mass $3M$ and speed V
 - B. Mass $3M$ and speed $2V$
 - C. Mass $2M$ and speed $3V$
 - D. Mass M and speed $4V$
 - E. All four of the above have the same kinetic energy
- ans: C
31. Two trailers, X with mass 500 kg and Y with mass 2000 kg, are being pulled at the same speed. The ratio of the kinetic energy of Y to that of X is:
- A. 1:1
 - B. 2:1
 - C. 4:1
 - D. 9:1
 - E. 1500:1
- ans: C
32. A 8000-N car is traveling at 12 m/s along a horizontal road when the brakes are applied. The car skids to a stop in 4.0 s. How much kinetic energy does the car lose in this time?
- A. 4.8×10^4 J
 - B. 5.9×10^4 J
 - C. 1.2×10^5 J
 - D. 5.8×10^5 J
 - E. 4.8×10^6 J
- ans: B
33. The velocity of a particle moving along the x axis changes from v_i to v_f . For which values of v_i and v_f is the total work done on the particle positive?
- A. $v_i = 5$ m/s, $v_f = 2$ m/s
 - B. $v_i = 5$ m/s, $v_f = -2$ m/s
 - C. $v_i = -5$ m/s, $v_f = -2$ m/s
 - D. $v_i = -5$ m/s, $v_f = 2$ m/s
 - E. $v_i = 2$ m/s, $v_f = -5$ m/s
- ans: E
34. An object is constrained by a cord to move in a circular path of radius 0.5 m on a horizontal frictionless surface. The cord will break if its tension exceeds 16 N. The maximum kinetic energy the object can have is:
- A. 4 J
 - B. 8 J
 - C. 16 J
 - D. 32 J
 - E. 64 J
- ans: A

35. The weight of an object on the moon is one-sixth of its weight on Earth. The ratio of the kinetic energy of a body on Earth moving with speed V to that of the same body moving with speed V on the moon is:

- A. 6:1
- B. 36:1
- C. 1:1
- D. 1:6
- E. 1:36

ans: C

36. Which of the following is the correct combination of dimensions for energy?

- A. MLT
- B. LT^2/m
- C. ML^2/T^2
- D. M^2L^3T
- E. ML/T^2

ans: C

37. The amount of work required to stop a moving object is equal to:

- A. the velocity of the object
- B. the kinetic energy of the object
- C. the mass of the object times its acceleration
- D. the mass of the object times its velocity
- E. the square of the velocity of the object

ans: B

38. A 5.0-kg cart is moving horizontally at 6.0 m/s. In order to change its speed to 10.0 m/s, the net work done on the cart must be:

- A. 40 J
- B. 90 J
- C. 160 J
- D. 400 J
- E. 550 J

ans: C

39. A crate is initially at rest on a horizontal frictionless table. A constant horizontal force F is applied. Which of the following five graphs is a correct plot of work W as a function of the crate's speed v ?

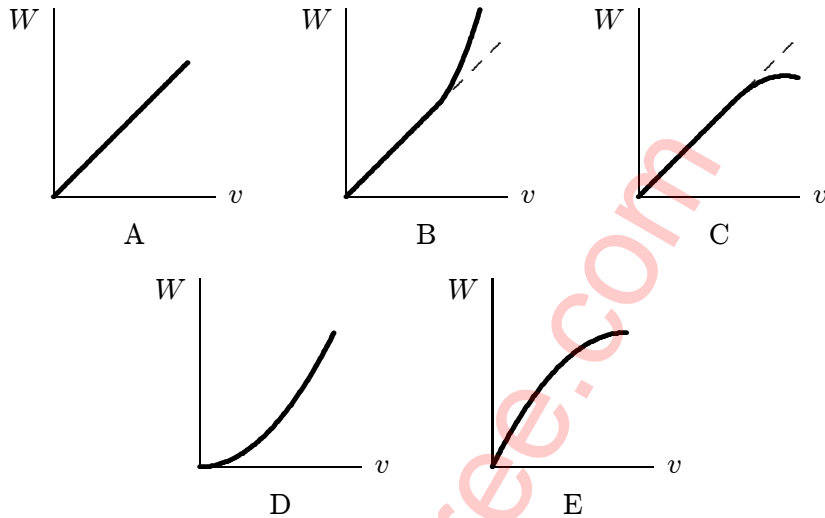

ans: D

40. An 8-N block slides down an incline. It has an initial speed of 7 m/s. The work done by the resultant force on this block is:
- 3 J
 - 6 J
 - 56 J
 - impossible to calculate without more information
 - none of these

ans: D

41. A 4-kg cart starts up an incline with a speed of 3 m/s and comes to rest 2 m up the incline. The total work done on the car is:
- 6 J
 - 8 J
 - 12 J
 - 18 J
 - impossible to calculate without more information

ans: D

42. Two objects with masses of m_1 and m_2 have the same kinetic energy and are both moving to the right. The same constant force \vec{F} is applied to the left to both masses. If $m_1 = 4m_2$, the ratio of the stopping distance of m_1 to that of m_2 is:
- 1:4
 - 4:1
 - 1:2
 - 2:1
 - 1:1

ans: E

43. A Boston Red Sox baseball player catches a ball of mass m that is moving toward him with speed v . While bringing the ball to rest, his hand moves back a distance d . Assuming constant deceleration, the horizontal force exerted on the ball by his hand is:
- A. mv/d
 - B. $mv d$
 - C. mv^2/d
 - D. $2mv/d$
 - E. $mv^2/(2d)$
- ans: E
44. A 0.50-kg object moves on a horizontal circular track with a radius of 2.5 m. An external force of 3.0 N, always tangent to the track, causes the object to speed up as it goes around. If it starts from rest its speed at the end of one revolution is:
- A. 9.8 m/s
 - B. 14 m/s
 - C. 15 m/s
 - D. 19 m/s
 - E. 21 m/s
- ans: B
45. A 0.50-kg object moves on a horizontal frictionless circular track with a radius of 2.5 m. An external force of 3.0 N, always tangent to the track, causes the object to speed up as it goes around. If it starts from rest, then at the end of one revolution the radial component of the force of the track on it is:
- A. 19 N
 - B. 38 N
 - C. 47 N
 - D. 75 N
 - E. 96 N
- ans: B
46. A 2-kg block is attached to a horizontal ideal spring with a spring constant of 200 N/m. When the spring has its equilibrium length the block is given a speed of 5 m/s. What is the maximum elongation of the spring?
- A. 0
 - B. 0.05 m
 - C. 5 m
 - D. 10 m
 - E. 100 m
- ans: C

47. At time $t = 0$ a particle starts moving along the x axis. If its kinetic energy increases uniformly with t the net force acting on it must be:
- A. constant
 - B. proportional to t
 - C. inversely proportional to t
 - D. proportional to \sqrt{t}
 - E. proportional to $1/\sqrt{t}$
- ans: E
48. At time $t = 0$ a 2-kg particle has a velocity of $(4 \text{ m/s})\hat{i} - (3 \text{ m/s})\hat{j}$. At $t = 3 \text{ s}$ its velocity is $(2 \text{ m/s})\hat{i} + (3 \text{ m/s})\hat{j}$. During this time the work done on it was:
- A. 4 J
 - B. -4 J
 - C. -12 J
 - D. -40 J
 - E. $(4 \text{ J})\hat{i} + (36 \text{ J})\hat{j}$
- ans: C
49. A particle starts from rest at time $t = 0$ and moves along the x axis. If the net force on it is proportional to t , its kinetic energy is proportional to:
- A. t
 - B. t^2
 - C. t^4
 - D. $1/t^2$
 - E. none of the above
- ans: C
50. A 1.5-kg crate falls from a height of 2.0 m onto an industrial spring scale with a spring constant of $1.5 \times 10^5 \text{ N/m}$. At its greatest compression the reading on the scale is:
- A. 15 N
 - B. 30 N
 - C. $1.5 \times 10^3 \text{ N}$
 - D. $2.1 \times 10^3 \text{ N}$
 - E. $3.0 \times 10^3 \text{ N}$
- ans: E
51. A particle moving along the x axis is acted upon by a single force $F = F_0 e^{-kx}$, where F_0 and k are constants. The particle is released from rest at $x = 0$. It will attain a maximum kinetic energy of:
- A. F_0/k
 - B. F_0/e^k
 - C. kF_0
 - D. $1/2(kF_0)^2$
 - E. $ke^k F_0$
- ans: A

52. The mechanical advantage of any machine is:
- A. the efficiency of the machine
 - B. the work done by the machine
 - C. the ratio of the work done by the machine to the work expended on it
 - D. the ratio of the force exerted by the machine to the force applied to it
 - E. the ratio of the force applied to the machine to the force exerted by it
- ans: D
53. In raising an object to a given height by means of an inclined plane, as compared with raising the object vertically, there is a reduction in:
- A. work required
 - B. distance pushed
 - C. friction
 - D. force required
 - E. value of the acceleration due to gravity
- ans: D
54. A watt is:
- A. $\text{kg} \cdot \text{m}/\text{s}^3$
 - B. $\text{kg} \cdot \text{m}^2/\text{s}$
 - C. $\text{kg} \cdot \text{m}^2/\text{s}^3$
 - D. $\text{kg} \cdot \text{m}/\text{s}$
 - E. $\text{kg} \cdot \text{m}^2/\text{s}^2$
- ans: C
55. Power has the dimensions of:
- A. ML^2/T^2
 - B. MT/L^2
 - C. ML/T^2
 - D. ML^2/T^3
 - E. none of these
- ans: D
56. Which of the following five units represents a quantity that is NOT the same as the other four?
- A. joule
 - B. erg
 - C. watt
 - D. foot·pound
 - E. newton·meter
- ans: C

57. Which of the following five quantities is NOT an expression for energy? Here m is a mass, g is the acceleration due to gravity, h and d are distances, F is a force, v is a speed, a is an acceleration, P is power, and t is time.

- A. mgh
- B. Fd
- C. $1/2mv^2$
- D. ma
- E. Pt

ans: D

58. A watt-second is a unit of:

- A. force
- B. power
- C. displacement
- D. speed
- E. energy

ans: E

59. A watt per hour is a unit of:

- A. energy
- B. power
- C. force
- D. acceleration
- E. none of these

ans: E

60. A kilowatt-hour is a unit of:

- A. power
- B. energy/time
- C. work
- D. power/time
- E. force/distance

ans: C

61. A man moves the 10-g object shown in a vertical plane from position X to position Y along a circular track of radius 20 m. The process takes 0.75 min. The work done by the man is about:

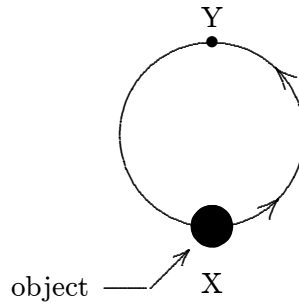

- A. 1 J
- B. 2 J
- C. 4 J
- D. 6 J
- E. 12 J

ans: C

62. A woman lifts a barbell 2.0 m in 5.0 s. If she lifts it the same distance in 10 s, the work done by her is:

- A. four times as great
- B. two times as great
- C. the same
- D. half as great
- E. one-fourth as great

ans: C

63. An escalator is used to move 20 people (60 kg each) per minute from the first floor of a department store to the second floor, 5 m above. Neglecting friction, the power required is approximately:

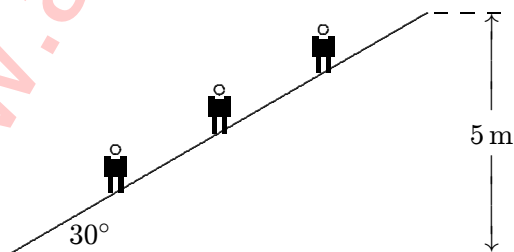

- A. 100 W
- B. 200 W
- C. 1000 W
- D. 2000 W
- E. 60,000 W

ans: C

64. A person holds an 80-N weight 2 m above the floor for 30 seconds. The power required to do this is:
- A. 80 W
 - B. 40 W
 - C. 20 W
 - D. 10 W
 - E. none of these
- ans: E
65. A 50-N force is the only force on a 2-kg object that starts from rest. When the force has been acting for 2 s the rate at which it is doing work is:
- A. 75 W
 - B. 100 W
 - C. 1000 W
 - D. 2500 W
 - E. 5000 W
- ans: D
66. A 50-N force is the only force a 2-kg crate that starts from rest. At the instant the object has gone 2 m the rate at which the force is doing work is:
- A. 2.5 W
 - B. 25 W
 - C. 75 W
 - D. 100 W
 - E. 500 W
- ans: E
67. A particle starts from rest and is acted on by a net force that does work at a rate that is proportional to the time t . The speed of the particle is proportional to:
- A. \sqrt{t}
 - B. t
 - C. t^2
 - D. $1/\sqrt{t}$
 - E. $1/t$
- ans: A

Chapter 8: POTENTIAL ENERGY AND CONSERVATION OF ENERGY

1. Only if a force on a particle is conservative:
 - A. is its work zero when the particle moves exactly once around any closed path
 - B. is its work always equal to the change in the kinetic energy of the particle
 - C. does it obey Newton's second law
 - D. does it obey Newton's third law
 - E. is it not a frictional forceans: A

2. A nonconservative force:
 - A. violates Newton's second law
 - B. violates Newton's third law
 - C. cannot do any work
 - D. must be perpendicular to the velocity of the particle on which it acts
 - E. none of the aboveans: E

3. The sum of the kinetic and potential energies of a system of objects is conserved:
 - A. only when no external force acts on the objects
 - B. only when the objects move along closed paths
 - C. only when the work done by the resultant external force is zero
 - D. always
 - E. none of the aboveans: E

4. A force on a particle is conservative if:
 - A. its work equals the change in the kinetic energy of the particle
 - B. it obeys Newton's second law
 - C. it obeys Newton's third law
 - D. its work depends on the end points of every motion, not on the path between
 - E. it is not a frictional forceans: D

5. Two particles interact by conservative forces. In addition, an external force acts on each particle. They complete round trips, ending at the points where they started. Which of the following must have the same values at the beginning and end of this trip?
 - A. the total kinetic energy of the two-particle system
 - B. the potential energy of the two-particle system
 - C. the mechanical energy of the two-particle system
 - D. the total linear momentum of the two-particle system
 - E. none of the aboveans: B

6. Two objects interact with each other and with no other objects. Initially object A has a speed of 5 m/s and object B has a speed of 10 m/s. In the course of their motion they return to their initial positions. Then A has a speed of 4 m/s and B has a speed of 7 m/s. We can conclude:
- A. the potential energy changed from the beginning to the end of the trip
 - B. mechanical energy was increased by nonconservative forces
 - C. mechanical energy was decreased by nonconservative forces
 - D. mechanical energy was increased by conservative forces
 - E. mechanical energy was decreased by conservative forces

ans: C

7. A good example of kinetic energy is provided by:

- A. a wound clock spring
- B. the raised weights of a grandfather's clock
- C. a tornado
- D. a gallon of gasoline
- E. an automobile storage battery

ans: C

8. No kinetic energy is possessed by:

- A. a shooting star
- B. a rotating propeller on a moving airplane
- C. a pendulum at the bottom of its swing
- D. an elevator standing at the fifth floor
- E. a cyclone

ans: D

9. The wound spring of a clock possesses:

- A. kinetic but no potential energy
- B. potential but no kinetic energy
- C. both potential and kinetic energy in equal amounts
- D. neither potential nor kinetic energy
- E. both potential and kinetic energy, but more kinetic energy than potential energy

ans: B

10. A body at rest in a system is capable of doing work if:

- A. the potential energy of the system is positive
- B. the potential energy of the system is negative
- C. it is free to move in such a way as to decrease its kinetic energy
- D. it is free to move in such a way as to decrease the potential energy of the system
- E. it is free to move in such a way as to increase the potential energy of the system

ans: D

11. Which one of the following five quantities CANNOT be used as a unit of potential energy?
- watt·second
 - gram·cm/s²
 - joule
 - kg·m²/s²
 - ft·lb

ans: B

12. Suppose that the fundamental dimensions are taken to be: force (F), velocity (V) and time (T). The dimensions of potential energy are then:

- F/T
- FVT
- FV/T
- F/T²
- FV²/T²

ans: B

13. The graphs below show the magnitude of the force on a particle as the particle moves along the positive x axis from the origin to $x = x_1$. The force is parallel to the x axis and is conservative. The maximum magnitude F_1 has the same value for all graphs. Rank the situations according to the change in the potential energy associated with the force, least (or most negative) to greatest (or most positive).

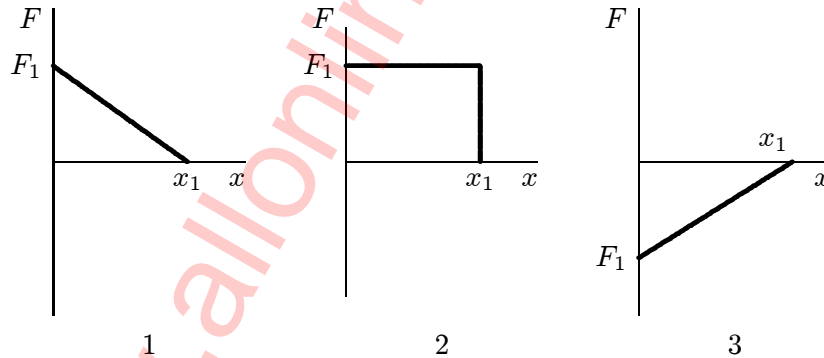

- 1, 2, 3
- 1, 3, 2
- 2, 3, 1
- 3, 2, 1
- 2, 1, 3

ans: E

14. A golf ball is struck by a golf club and falls on a green three meters above the tee. The potential energy of the Earth-ball system is greatest:
- just before the ball is struck
 - just after the ball is struck
 - just after the ball lands on the green
 - when the ball comes to rest on the green
 - when the ball reaches the highest point in its flight

ans: E

15. A ball is held at a height H above a floor. It is then released and falls to the floor. If air resistance can be ignored, which of the five graphs below correctly gives the mechanical energy E of the Earth-ball system as a function of the altitude y of the ball?

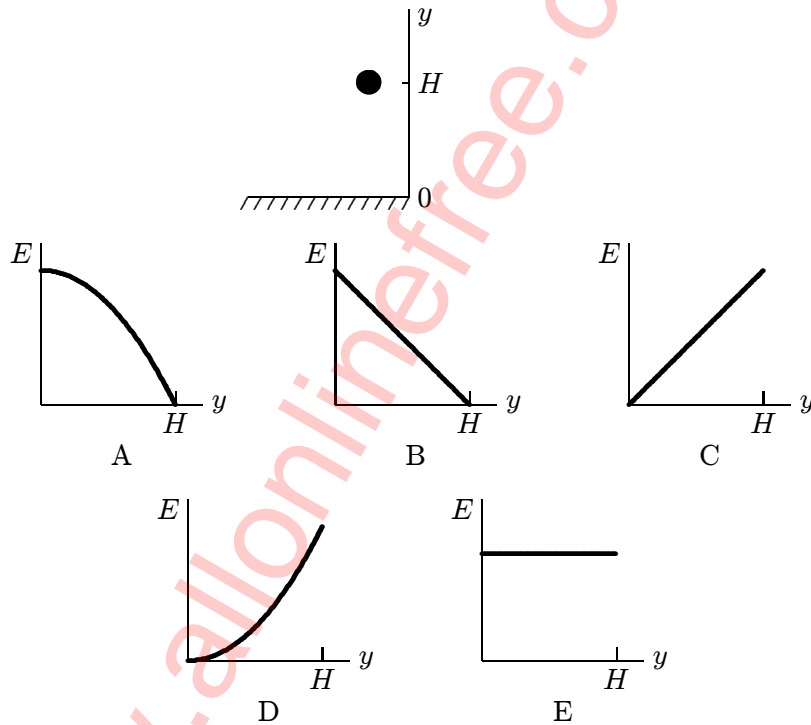

ans: E

16. A 6.0-kg block is released from rest 80 m above the ground. When it has fallen 60 m its kinetic energy is approximately:
- 4800 J
 - 3500 J
 - 1200 J
 - 120 J
 - 60 J

ans: B

17. A 2-kg block is thrown upward from a point 20 m above Earth's surface. At what height above Earth's surface will the gravitational potential energy of the Earth-block system have increased by 500 J?
- 5 m
 - 25 m
 - 46 m
 - 70 m
 - 270 m

ans: C

18. An elevator is rising at constant speed. Consider the following statements:
- the upward cable force is constant
 - the kinetic energy of the elevator is constant
 - the gravitational potential energy of the Earth-elevator system is constant
 - the acceleration of the elevator is zero
 - the mechanical energy of the Earth-elevator system is constant
- all five are true
 - only II and V are true
 - only IV and V are true
 - only I, II, and III are true
 - only I, II, and IV are true

ans: E

19. A projectile of mass 0.50 kg is fired with an initial speed of 10 m/s at an angle of 60° above the horizontal. The potential energy of the projectile-Earth system (relative potential energy when the projectile is at ground level) is:
- 25 J
 - 18.75 J
 - 12.5 J
 - 6.25 J
 - none of these

ans: B

20. For a block of mass m to slide without friction up the rise of height h shown, it must have a minimum initial kinetic energy of:

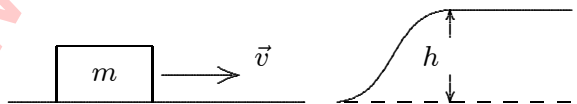

- gh
- mgh
- $gh/2$
- $mgh/2$
- $2mgh$

ans: B

21. A 2.2-kg block starts from rest on a rough inclined plane that makes an angle of 25° with the horizontal. The coefficient of kinetic friction is 0.25. As the block goes 2.0 m down the plane, the mechanical energy of the Earth-block system changes by:
- A. 0
 - B. -9.8 J
 - C. 9.8 J
 - D. -18 J
 - E. 18 J
- ans: B

22. A simple pendulum consists of a 2.0-kg mass attached to a string. It is released from rest at X as shown. Its speed at the lowest point Y is about:

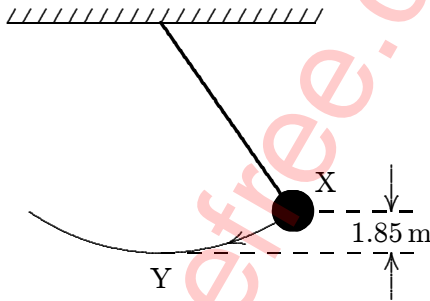

- A. 0.90 m/s
 - B. $\sqrt{3.6} \text{ m/s}$
 - C. 3.6 m/s
 - D. 6.0 m/s
 - E. 36 m/s
- ans: D

23. The long pendulum shown is drawn aside until the ball has risen 0.50 m. It is then given an initial speed of 3.0 m/s . The speed of the ball at its lowest position is:

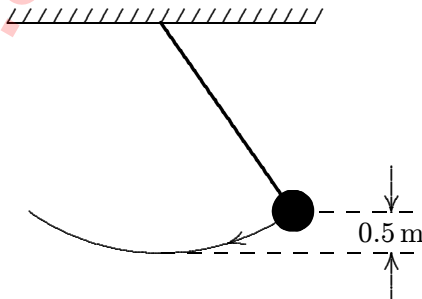

- A. zero
 - B. 0.89 m/s
 - C. 3.1 m/s
 - D. 3.7 m/s
 - E. 4.3 m/s
- ans: E

24. A particle moves along the x axis under the influence of a stationary object. The net force on the particle is given by $F = (8\text{N/m}^3)x^3$. If the potential energy is taken to be zero for $x = 0$ then the potential energy is given by:

- A. $(2\text{J/m}^4)x^4$
- B. $(-2\text{J/m}^4)x^4$
- C. $(24\text{J/m}^2)x^2$
- D. $(-24\text{J/m}^2)x^2$
- E. $5\text{J} - (2\text{J/m}^4)x^4$

ans: B

25. A 0.20-kg particle moves along the x axis under the influence of a stationary object. The potential energy is given by

$$U(x) = (8.0\text{J/m}^2)x^2 + (2.0\text{J/m}^4)x^4,$$

where x is in coordinate of the particle. If the particle has a speed of 5.0 m/s when it is at $x = 1.0$ m, its speed when it is at the origin is:

- A. 0
- B. 2.5 m/s
- C. 5.7 m/s
- D. 7.9 m/s
- E. 11 m/s

ans: E

26. Which of the five graphs correctly shows the potential energy of a spring as a function of its elongation x ?

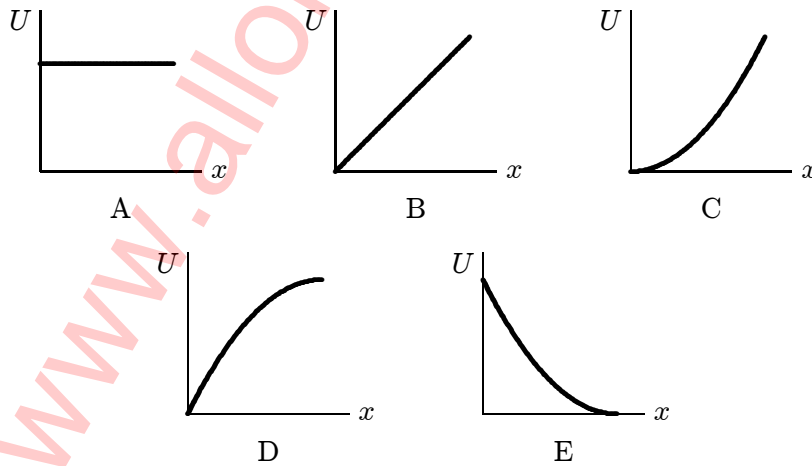

ans: C

27. A force of 10 N holds an ideal spring with a 20-N/m spring constant in compression. The potential energy stored in the spring is:
- A. 0.5 J
 - B. 2.5 J
 - C. 5 J
 - D. 10 J
 - E. 200 J
- ans: B
28. An ideal spring is used to fire a 15.0-g pellet horizontally. The spring has a spring constant of 20 N/m and is initially compressed by 7.0 cm. The kinetic energy of the pellet as it leaves the spring is:
- A. zero
 - B. 2.5×10^{-2} J
 - C. 4.9×10^{-2} J
 - D. 9.8×10^{-2} J
 - E. 1.4 J
- ans: C
29. A 0.50-kg block attached to an ideal spring with a spring constant of 80 N/m oscillates on a horizontal frictionless surface. The total mechanical energy is 0.12 J. The greatest extension of the spring from its equilibrium length is:
- A. 1.5×10^{-3} m
 - B. 3.0×10^{-3} m
 - C. 0.039 m
 - D. 0.054 m
 - E. 18 m
- ans: D
30. A 0.50-kg block attached to an ideal spring with a spring constant of 80 N/m oscillates on a horizontal frictionless surface. The total mechanical energy is 0.12 J. The greatest speed of the block is:
- A. 0.15 m/s
 - B. 0.24 m/s
 - C. 0.49 m/s
 - D. 0.69 m/s
 - E. 1.46 m/s
- ans: D
31. A 0.50-kg block attached to an ideal spring with a spring constant of 80 N/m oscillates on a horizontal frictionless surface. When the spring is 4.0 cm longer than its equilibrium length, the speed of the block is 0.50 m/s. The greatest speed of the block is:
- A. 0.23 m/s
 - B. 0.32 m/s
 - C. 0.55 m/s
 - D. 0.71 m/s
 - E. 0.93 m/s
- ans: D

32. A 0.5-kg block slides along a horizontal frictionless surface at 2 m/s. It is brought to rest by compressing a very long spring of spring constant 800 N/m. The maximum spring compression is:
- A. 0
 - B. 3 cm
 - C. 5 cm
 - D. 80 cm
 - E. 80 m

ans: C

33. A block of mass m is initially moving to the right on a horizontal frictionless surface at a speed v . It then compresses a spring of spring constant k . At the instant when the kinetic energy of the block is equal to the potential energy of the spring, the spring is compressed a distance of:
- A. $v\sqrt{m/2k}$
 - B. $(1/2)mv^2$
 - C. $(1/4)mv^2$
 - D. $mv^2/4k$
 - E. $(1/4)\sqrt{mv/k}$

ans: A

34. A 700-N man jumps out of a window into a fire net 10 m below. The net stretches 2 m before bringing the man to rest and tossing him back into the air. The maximum potential energy of the net, compared to its unstretched potential energy, is:
- A. 300 J
 - B. 710 J
 - C. 850 J
 - D. 7000 J
 - E. 8400 J

ans: E

35. A toy cork gun contains a spring whose spring constant is 10.0 N/m. The spring is compressed 5.00 cm and then used to propel a 6.00-g cork. The cork, however, sticks to the spring for 1.00 cm beyond its unstretched length before separation occurs. The muzzle velocity of this cork is:

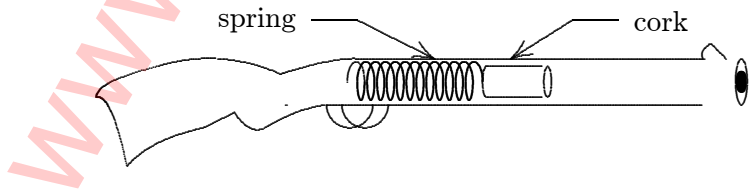

- A. 1.02 m/s
- B. 1.41 m/s
- C. 2.00 m/s
- D. 2.04 m/s
- E. 4.00 m/s

ans: C

36. A small object of mass m , on the end of a light cord, is held horizontally at a distance r from a fixed support as shown. The object is then released. What is the tension force of the cord when the object is at the lowest point of its swing?

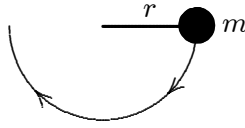

- A. $mg/2$
 B. mg
 C. $2mg$
 D. $3mg$
 E. mgr

ans: D

37. The string in the figure is 50 cm long. When the ball is released from rest, it swings along the dotted arc. How fast is it going at the lowest point in its swing?

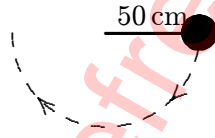

- A. 2.0 m/s
 B. 2.2 m/s
 C. 3.1 m/s
 D. 4.4 m/s
 E. 6.0 m/s

ans: C

38. A block is released from rest at point P and slides along the frictionless track shown. At point Q, its speed is:

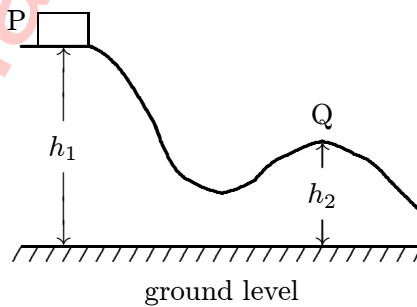

- A. $2g\sqrt{h_1 - h_2}$
 B. $2g(h_1 - h_2)$
 C. $(h_1 - h_2)/2g$
 D. $\sqrt{2g(h_1 - h_2)}$
 E. $(h_1 - h_2)^2/2g$

ans: D

39. A small object of mass m starts from rest at the position shown and slides along the frictionless loop-the-loop track of radius R . What is the smallest value of y such that the object will slide without losing contact with the track?

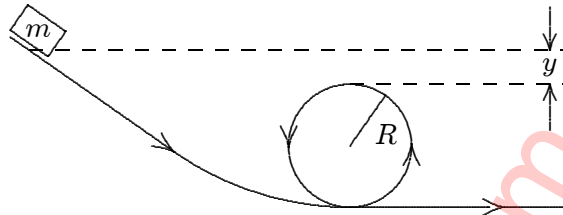

- A. $R/4$
- B. $R/2$
- C. R
- D. $2R$
- E. zero

ans: B

40. A small object slides along the frictionless loop-the-loop with a diameter of 3 m. What minimum speed must it have at the top of the loop?

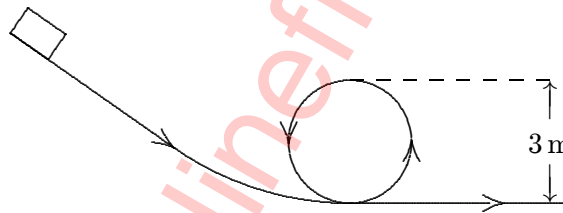

- A. 1.9 m/s
- B. 3.8 m/s
- C. 5.4 m/s
- D. 15 m/s
- E. 29 m/s

ans: B

41. A rectangular block is moving along a frictionless path when it encounters the circular loop as shown. The block passes points 1, 2, 3, 4, 1 before returning to the horizontal track. At point 3:

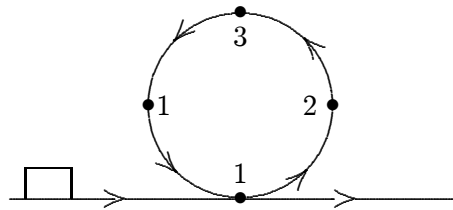

- A. its mechanical energy is a minimum
- B. the forces on it are balanced
- C. it is not accelerating
- D. its speed is a minimum
- E. it experiences a net upward force

ans: D

42. A ball of mass m , at one end of a string of length L , rotates in a vertical circle just fast enough to prevent the string from going slack at the top of the circle. The speed of the ball at the bottom of the circle is:

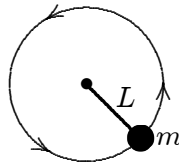

- A. $\sqrt{2gL}$
 B. $\sqrt{3gL}$
 C. $\sqrt{4gL}$
 D. $\sqrt{5gL}$
 E. $\sqrt{7gL}$

ans: D

43. A particle is released from rest at the point $x = a$ and moves along the x axis subject to the potential energy function $U(x)$ shown. The particle:

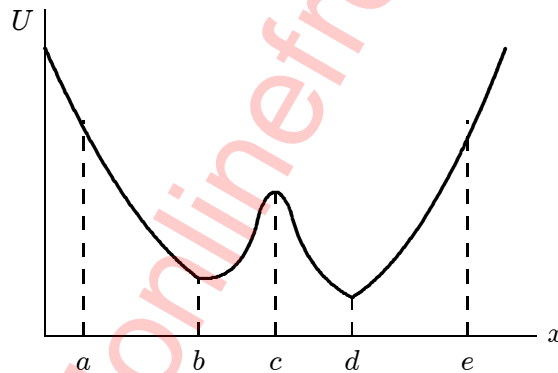

- A. moves to a point to the left of $x = e$, stops, and remains at rest
 B. moves to a point to $x = e$, then moves to the left
 C. moves to infinity at varying speed
 D. moves to $x = b$, where it remains at rest
 E. moves to $x = e$ and then to $x = d$, where it remains at rest

ans: B

44. The potential energy of a particle moving along the x axis is given by

$$U(x) = (8.0 \text{ J/m}^2)x^2 + (2.0 \text{ J/m}^4)x^4.$$

If the total mechanical energy is 9.0 J, the limits of motion are:

- A. $-0.96 \text{ m}; +0.96 \text{ m}$
 B. $-2.2 \text{ m}; +2.2 \text{ m}$
 C. $-1.6 \text{ m}; +1.6 \text{ m}$
 D. $-0.96 \text{ m}; +2.2 \text{ m}$
 E. $-0.96 \text{ m}; +1.6 \text{ m}$

ans: A

45. The potential energy of a 0.20-kg particle moving along the x axis is given by

$$U(x) = (8.0 \text{ J/m}^2)x^2 + (2.0 \text{ J/m}^4)x^4.$$

When the particle is at $x = 1.0 \text{ m}$ it is traveling in the positive x direction with a speed of 5.0 m/s . It next stops momentarily to turn around at $x =$

- A. 0
- B. -1.1 m
- C. 1.1 m
- D. -2.3 m
- E. 2.3 m

ans: C

46. Given a potential energy function $U(x)$, the corresponding force \vec{F} is in the positive x direction if:

- A. U is positive
- B. U is negative
- C. U is an increasing function of x
- D. U is a decreasing function of x
- E. it is impossible to obtain the direction of \vec{F} from U

ans: D

47. As a particle moves along the x axis it is acted upon by a conservative force. The potential energy is shown below as a function of the coordinate x of the particle. Rank the labeled regions according to the magnitude of the force, least to greatest.

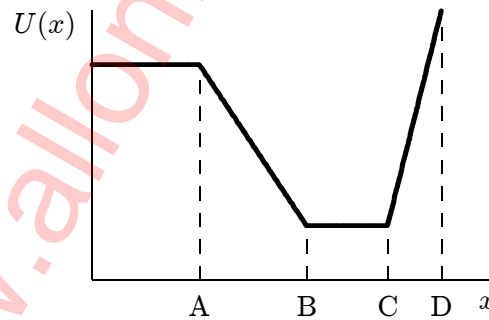

- A. AB, BC, CD
- B. AB, CD, BC
- C. BC, CD, AB
- D. BC, AB, CD
- E. CD, BC, AB

ans: D

48. The first graph shows the potential energy $U(x)$ for a particle moving on the x axis. Which of the other five graphs correctly gives the force F exerted on the particle?

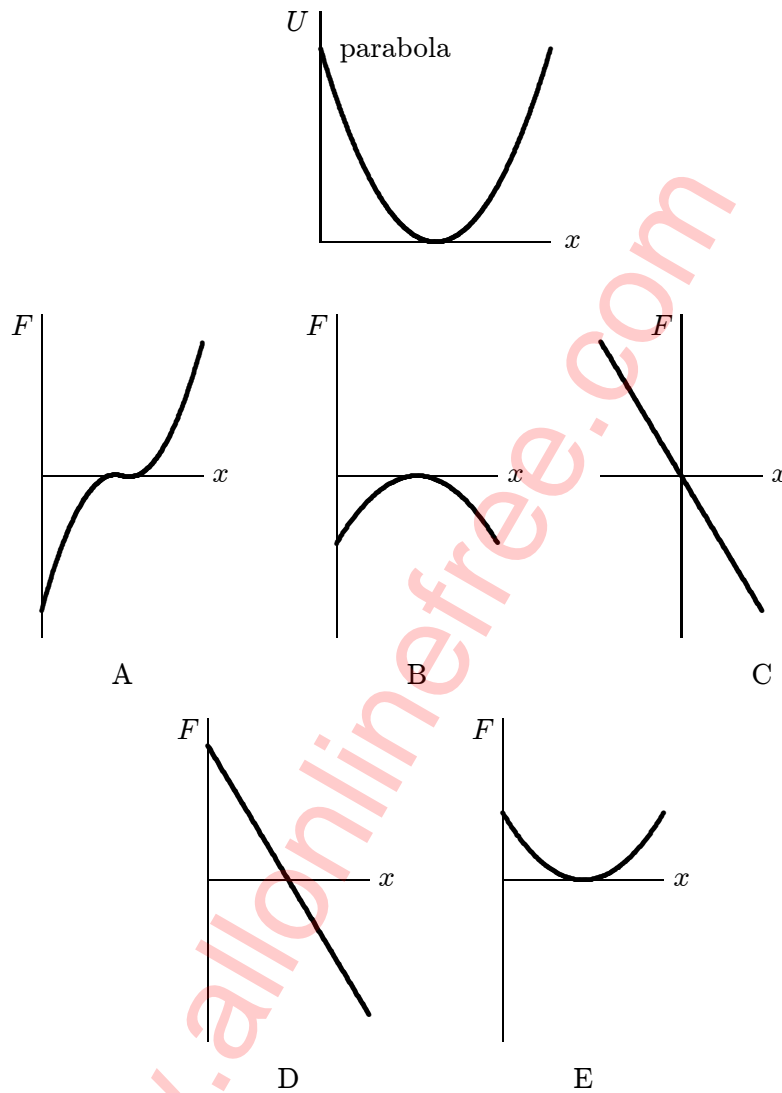

ans: D

49. The diagram shows a plot of the potential energy as a function of x for a particle moving along the x axis. The points of stable equilibrium are:

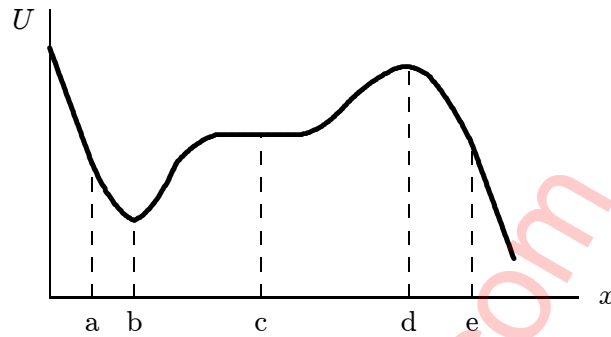

- A. only a
 B. only b
 C. only c
 D. only d
 E. b and d

ans: B

50. The diagram shows a plot of the potential energy as a function of x for a particle moving along the x axis. The points of unstable equilibrium are:

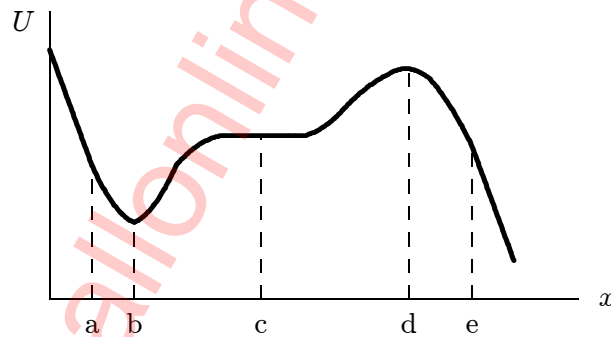

- A. only a
 B. only b
 C. only c
 D. only d
 E. b and d

ans: D

51. The diagram shows a plot of the potential energy as a function of x for a particle moving along the x axis. Of the labeled points, the points of neutral equilibrium are:

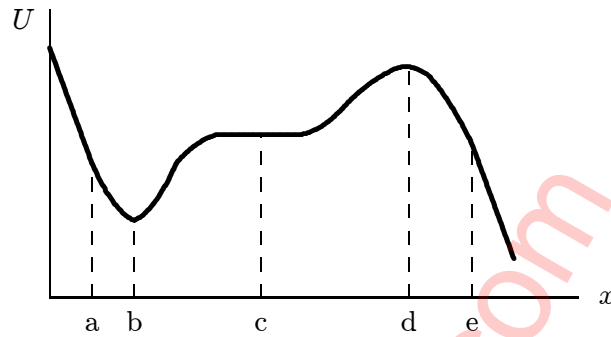

- A. only a
 B. only b
 C. only c
 D. only d
 E. b and d

ans: C

52. The potential energy of a body of mass m is given by $U = -mgx + \frac{1}{2}kx^2$. The corresponding force is:

- A. $-mgx^2/2 + kx^3/6$
 B. $mgx^2/2 - kx^3/6$
 C. $-mg + kx/2$
 D. $-mg + kx$
 E. $mg - kx$

ans: E

53. The potential energy of a 0.20-kg particle moving along the x axis is given by

$$U(x) = (8.0 \text{ J/m}^2)x^2 + (2.0 \text{ J/m}^4)x^4.$$

When the particle is at $x = 1.0$ m the magnitude of its acceleration is:

- A. 0
 B. -8 m/s^2
 C. 8 m/s^2
 D. -40 m/s^2
 E. 40 m/s^2

ans: D

54. The potential energy for the interaction between the two atoms in a diatomic molecule is $U = A/x^{12} - B/x^6$, where A and B are constants and x is the interatomic distance. The magnitude of the force of one atom on the other is:

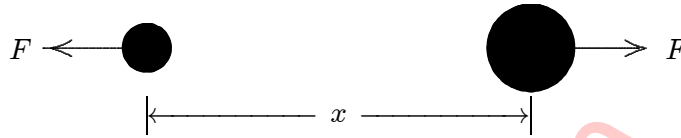

- A. $12A/|x|^{13} - 6B/|x|^7$
 B. $-13A/|x|^{13} + 7B/|x|^7$
 C. $-11A/|x|^{11} + 5B/|x|^5$
 D. $72A/|x|^{12} - 72B/|x|^6$
 E. $A/|x|^{13} - B/|x|^7$

ans: A

55. The thermal energy of a system consisting of a thrown ball, Earth, and the air is most closely associated with:

- A. the gravitational interaction of Earth and the ball
 B. the kinetic energy of the ball as a whole
 C. motions of the individual particles within the ball
 D. motions of individual particles within the ball and the air
 E. the kinetic energy of Earth as a whole

ans: D

56. Three identical blocks move either on a horizontal surface, up a plane, or down a plane, as shown below. They start with different speeds and continue to move until brought to rest by friction. They all move the same distance. Rank the three situations according to the initial speeds, least to greatest.

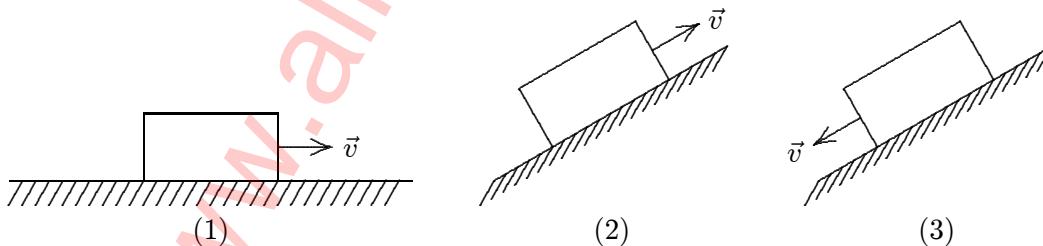

- A. The same for all cases
 B. 1, 2, 3
 C. 1, then 2 and 3 tie
 D. 3, 1, 2
 E. 2, 1, 3

ans: D

57. Objects A and B interact with each other via both conservative and nonconservative forces. Let K_A and K_B be the kinetic energies, U be the potential energy, and E_{int} be the thermal energy. If no external agent does work on the objects then:
- A. $K_A + U$ is conserved
 - B. $K_A + U + E_{\text{int}}$ is conserved
 - C. $K_A + K_B + E_{\text{int}}$ is conserved
 - D. $K_A + K_B + U$ is conserved
 - E. $K_A + K_B + U + E_{\text{int}}$ is conserved
- ans: E
58. A block slides across a rough horizontal table top. The work done by friction changes:
- A. only the kinetic energy
 - B. only the potential energy
 - C. only the internal energy
 - D. only the kinetic and potential energies
 - E. only the kinetic and internal energies
- ans: E
59. A 25-g ball is released from rest 80 m above the surface of Earth. During the fall the total internal energy of the ball and air increases by 15 J. Just before it hits the surface its speed is
- A. 19 m/s
 - B. 36 m/s
 - C. 40 m/s
 - D. 45 m/s
 - E. 53 m/s
- ans: A
60. A 5-kg projectile is fired over level ground with a velocity of 200 m/s at an angle of 25° above the horizontal. Just before it hits the ground its speed is 150 m/s. Over the entire trip the change in the internal energy of the projectile and air is:
- A. +19,000 J
 - B. -19,000 J
 - C. +44,000 J
 - D. -44,000 J
 - E. 0
- ans: C
61. A 0.75-kg block slides on a rough horizontal table top. Just before it hits a horizontal ideal spring its speed is 3.5 m/s. It compresses the spring 5.7 cm before coming to rest. If the spring constant is 1200 N/m, the internal energy of the block and the table top must have:
- A. not changed
 - B. decreased by 1.9 J
 - C. decreased by 2.6 J
 - D. increased by 1.9 J
 - E. increased by 2.6 J
- ans: C

Chapter 9: CENTER OF MASS AND LINEAR MOMENTUM

1. Which one of the following statements is true?
- A. the center of mass of an object must lie within the object
 - B. all the mass of an object is actually concentrated at its center of mass
 - C. the center of mass of an object cannot move if there is zero net force on the object
 - D. the center of mass of a cylinder must lie on its axis
 - E. none of the above

ans: E

2. The x and y coordinates of the center of mass of the three-particle system shown below are:

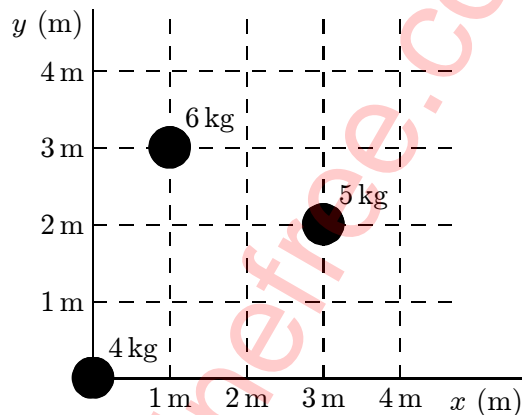

- A. 0, 0
- B. 1.3 m, 1.7 m
- C. 1.4 m, 1.9 m
- D. 1.9 m, 2.5 m
- E. 1.4 m, 2.5 m

ans: C

3. The center of mass of a uniform disk of radius R is located:
- A. on the rim
 - B. a distance $R/2$ from the center
 - C. a distance $R/3$ from the center
 - D. a distance $2R/3$ from the center
 - E. at the center

ans: E

4. The center of mass of the system consisting of Earth, the Sun, and the planet Mars is:
- A. closer to Earth than to either of the other bodies
 - B. closer to the Sun than to either of the other bodies
 - C. closer to Mars than to either of the other bodies
 - D. at the geometric center of the triangle formed by the three bodies
 - E. at the center of the line joining Earth and Mars

ans: B

5. The center of mass of Earth's atmosphere is:
- a little less than halfway between Earth's surface and the outer boundary of the atmosphere
 - near the surface of Earth
 - near the outer boundary of the atmosphere
 - near the center of Earth
 - none of the above

ans: D

6. A thick uniform wire is bent into the shape of the letter "U" as shown. Which point indicates the location of the center of mass of this wire?

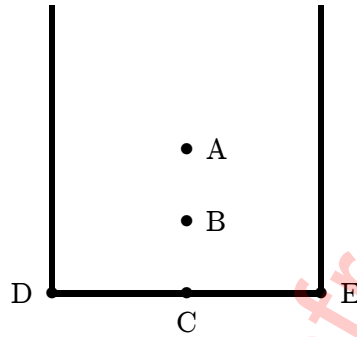

ans: B

7. A machinist starts with three identical square plates but cuts one corner from one of them, two corners from the second, and three corners from the third. Rank the three plates according to the x coordinate of their centers of mass, from smallest to largest.

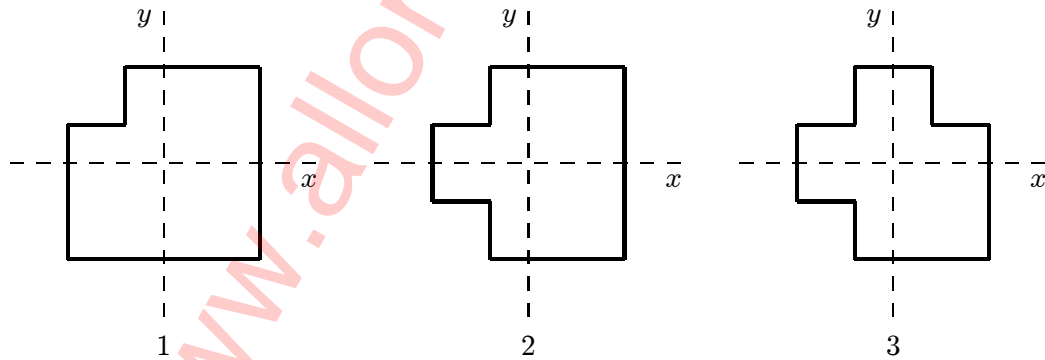

- 1, 2, 3
- 1 and 2 tie, then 3
- 1, then 2 and 3 tie
- 3, 2, 1
- 1 and 3 tie, then 2

ans: E

8. Block A, with a mass of 4 kg, is moving with a speed of 2.0 m/s while block B, with a mass of 8 kg, is moving in the opposite direction with a speed of 3 m/s. The center of mass of the two block-system is moving with a velocity of:
- A. 1.3 m/s in the same direction as A
 - B. 1.3 m/s in the same direction as B
 - C. 2.7 m/s in the same direction as A
 - D. 1.0 m/s in the same direction as B
 - E. 5.0 m/s in the same direction as A

ans: B

9. At the same instant that a 0.50-kg ball is dropped from 25 m above Earth, a second ball, with a mass of 0.25 kg, is thrown straight upward from Earth's surface with an initial speed of 15 m/s. They move along nearby lines and pass each other without colliding. At the end of 2.0 s the height above Earth's surface of the center of mass of the two-ball system is:

- A. 2.9 m
- B. 4.0 m
- C. 5.0 m
- D. 7.1 m
- E. 10.4 m

ans: D

10. At the same instant that a 0.50-kg ball is dropped from 25 m above Earth, a second ball, with a mass of 0.25 kg, is thrown straight upward from Earth's surface with an initial speed of 15 m/s. They move along nearby lines and pass without colliding. At the end of 2.0 s the velocity of the center of mass of the two-ball system is:

- A. 11 m/s, down
- B. 11 m/s, up
- C. 15 m/s, down
- D. 15 m/s, up
- E. 20 m/s, down

ans: C

11. At the same instant that a 0.50-kg ball is dropped from 25 m above Earth, a second ball, with a mass of 0.25 kg, is thrown straight upward from Earth's surface with an initial speed of 15 m/s. They move along nearby lines and pass without colliding. At the end of 2.0 s the magnitude of the acceleration of the center of mass of the two-ball system is:

- A. $0.25g$
- B. $0.50g$
- C. $0.75g$
- D. g
- E. $g/0.75$

ans: D

12. A light rope passes over a light frictionless pulley attached to the ceiling. An object with a large mass is tied to one end and an object with a smaller mass is tied to the other end. Starting from rest the heavier object moves downward and the lighter object moves upward with the same magnitude acceleration. Which of the following statements is true for the system consisting of the two masses?
- A. The center of mass remains at rest.
 - B. The net external force is zero.
 - C. The velocity of the center of mass is a constant.
 - D. The acceleration of the center of mass is g , downward.
 - E. None of the above statements are true.

ans: E

13. Two 4.0-kg blocks are tied together with a compressed spring between them. They are thrown from the ground with an initial velocity of 35 m/s, 45° above the horizontal. At the highest point of the trajectory they become untied and spring apart. About how far below the highest point is the center of mass of the two-block system 2.0 s later, before either fragment has hit the ground?
- A. 12 m
 - B. 20 m
 - C. 31 m
 - D. Can't tell because the velocities of the fragments are not given.
 - E. Can't tell because the coordinates of the highest point are not given.

ans: B

14. The center of mass of a system of particles has a constant velocity if:
- A. the forces exerted by the particles on each other sum to zero
 - B. the external forces acting on particles of the system sum to zero
 - C. the velocity of the center of mass is initially zero
 - D. the particles are distributed symmetrically around the center of mass
 - E. the center of mass is at the geometric center of the system

ans: B

15. The center of mass of a system of particles remains at the same place if:
- A. it is initially at rest and the external forces sum to zero
 - B. it is initially at rest and the internal forces sum to zero
 - C. the sum of the external forces is less than the maximum force of static friction
 - D. no friction acts internally
 - E. none of the above

ans: A

16. A man sits in the back of a canoe in still water. He then moves to the front of the canoe and sits there. Afterwards the canoe:
- A. is forward of its original position and moving forward
 - B. is forward of its original position and moving backward
 - C. is rearward of its original position and moving forward
 - D. is rearward of its original position and moving backward
 - E. is rearward of its original position and not moving

ans: E

17. A 640-N hunter gets a rope around a 3200-N polar bear. They are stationary, 20 m apart, on frictionless level ice. When the hunter pulls the polar bear to him, the polar bear will move:
- 1.0 m
 - 3.3 m
 - 10 m
 - 12 m
 - 17 m
- ans: B

18. Two boys, with masses of 40 kg and 60 kg, respectively, stand on a horizontal frictionless surface holding the ends of a light 10-m long rod. The boys pull themselves together along the rod. When they meet the 60-kg boy will have moved what distance?
- 4 m
 - 5 m
 - 6 m
 - 10 m
 - need to know the forces they exert
- ans: A

19. The center of mass of a system of particles obeys an equation similar to Newton's second law $\vec{F} = m\vec{a}_{\text{com}}$, where:
- \vec{F} is the net internal force and m is the total mass of the system
 - \vec{F} is the net internal force and m is the mass acting on the system
 - \vec{F} is the net external force and m is the total mass of the system
 - \vec{F} is the force of gravity and m is the mass of Earth
 - \vec{F} is the force of gravity and m is the total mass of the system
- ans: C

20. A large wedge with a mass of 10 kg rests on a horizontal frictionless surface, as shown. A block with a mass of 5.0 kg starts from rest and slides down the inclined surface of the wedge, which is rough. At one instant the vertical component of the block's velocity is 3.0 m/s and the horizontal component is 6.0 m/s. At that instant the velocity of the wedge is:

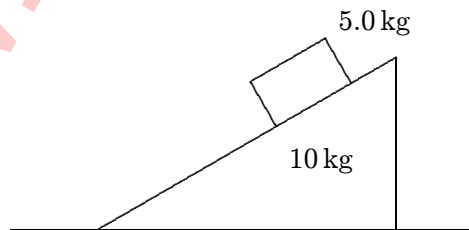

- 3.0 m/s to the left
 - 3.0 m/s to the right
 - 6.0 m/s to the right
 - 6.0 m/s to the left
 - 17 m/s to the right
- ans: B

21. A 2.0-kg block is attached to one end of a spring with a spring constant of 100 N/m and a 4.0-kg block is attached to the other end. The blocks are placed on a horizontal frictionless surface and set into motion. At one instant the 2.0-kg block is observed to be traveling to the right with a speed of 0.50 m/s and the 4.0-kg block is observed to be traveling to the left with a speed of 0.30 m/s. Since the only forces on the blocks are the force of gravity, the normal force of the surface, and the force of the spring, we conclude that:
- A. the spring is compressed at the time of the observation
 - B. the spring is not compressed at the time of observation
 - C. the motion was started with the masses at rest
 - D. the motion was started with at least one of masses moving
 - E. the motion was started by compressing the spring

ans: D

22. A 2.0-kg mass is attached to one end of a spring with a spring constant of 100 N/m and a 4.0-kg mass is attached to the other end. The masses are placed on a horizontal frictionless surface and the spring is compressed 10 cm. The spring is then released with the masses at rest and the masses oscillate. When the spring has its equilibrium length for the first time the 2.0-kg mass has a speed of 0.36 m/s. The mechanical energy that has been lost to the instant is:
- A. zero
 - B. 0.31 J
 - C. 0.61 J
 - D. 0.81 J
 - E. 1.2 J

ans: B

23. Momentum may be expressed in:
- A. kg/m
 - B. gram·s
 - C. N·s
 - D. kg/(m·s)
 - E. N/s

ans: C

24. The momentum of an object at a given instant is independent of its:
- A. inertia
 - B. mass
 - C. speed
 - D. velocity
 - E. acceleration

ans: E

25. Two bodies, A and B, have equal kinetic energies. The mass of A is nine times that of B. The ratio of the momentum of A to that of B is:
- 1:9
 - 1:3
 - 1:1
 - 3:1
 - 9:1

ans: D

26. Two objects, P and Q, have the same momentum. Q has more kinetic energy than P if it:
- weighs more than P
 - is moving faster than P
 - weighs the same as P
 - is moving slower than P
 - is moving at the same speed as P

ans: B

27. A particle moves along the x axis. Its momentum is graphed below as a function of time. Rank the numbered regions according to the magnitude of the force acting on the particle, least to greatest.

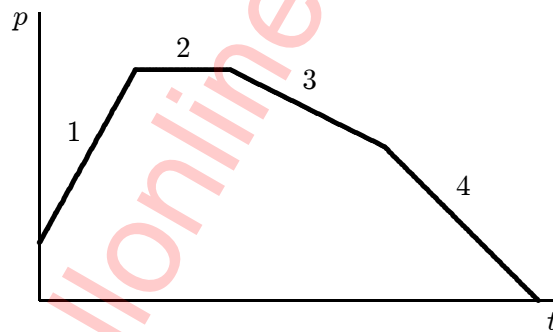

- 1, 2, 3, 4
- 2, 3, 4, 1
- 1, 4, 3, 2
- 1, 3, 4, 2
- 2, 4, 3, 1

ans: B

28. A 1.0-kg ball moving at 2.0 m/s perpendicular to a wall rebounds from the wall at 1.5 m/s. The change in the momentum of the ball is:
- zero
 - $0.5 \text{ N} \cdot \text{s}$ away from wall
 - $0.5 \text{ N} \cdot \text{s}$ toward wall
 - $3.5 \text{ N} \cdot \text{s}$ away from wall
 - $3.5 \text{ N} \cdot \text{s}$ toward wall

ans: D

29. If the total momentum of a system is changing:
- A. particles of the system must be exerting forces on each other
 - B. the system must be under the influence of gravity
 - C. the center of mass must have constant velocity
 - D. a net external force must be acting on the system
 - E. none of the above
- ans: D
30. When you step on the accelerator to increase the speed of your car, the force that accelerates the car is:
- A. the force of your foot on the accelerator
 - B. the force of friction of the road on the tires
 - C. the force of the engine on the drive shaft
 - D. the normal force of the road on the tires
 - E. none of the above
- ans: B
31. A 2.5-kg stone is released from rest and falls toward Earth. After 4.0 s, the magnitude of its momentum is:
- A. 98 kg · m/s
 - B. 78 kg · m/s
 - C. 39 kg · m/s
 - D. 24 kg · m/s
 - E. zero
- ans: A
32. A 64-kg woman stands on frictionless level ice with a 0.10-kg stone at her feet. She kicks the stone with her foot so that she acquires a velocity of 0.0017 m/s in the forward direction. The velocity acquired by the stone is:
- A. 1.1 m/s forward
 - B. 1.1 m/s backward
 - C. 0.0017 m/s forward
 - D. 0.0017 m/s backward
 - E. none of these
- ans: B
33. A man is marooned at rest on level frictionless ice. In desperation, he hurls his shoe to the right at 15 m/s. If the man weighs 720 N and the shoe weighs 4.0 N, the man moves to the left with a speed of:
- A. 0
 - B. 2.1×10^{-2} m/s
 - C. 8.3×10^{-2} m/s
 - D. 15 m/s
 - E. 2.7×10^3 m/s
- ans: C

34. Two spacemen are floating together with zero speed in a gravity-free region of space. The mass of spaceman A is 120 kg and that of spaceman B is 90 kg. Spaceman A pushes B away from him with B attaining a final speed of 0.5 m/s. The final recoil speed of A is:
- A. zero
 - B. 0.38 m/s
 - C. 0.5 m/s
 - D. 0.67 m/s
 - E. 1.0 m/s
- ans: B
35. A projectile in flight explodes into several fragments. The total momentum of the fragments immediately after this explosion:
- A. is the same as the momentum of the projectile immediately before the explosion
 - B. has been changed into kinetic energy of the fragments
 - C. is less than the momentum of the projectile immediately before the explosion
 - D. is more than the momentum of the projectile immediately before the explosion
 - E. has been changed into radiant energy
- ans: A
36. A rifle of mass M is initially at rest but free to recoil. It fires a bullet of mass m and velocity v (relative to the ground). After firing, the velocity of the rifle (relative to the ground) is:
- A. $-mv$
 - B. $-Mv/m$
 - C. $-mv/M$
 - D. $-v$
 - E. mv/M
- ans: C
37. Bullets from two revolvers are fired with the same velocity. The bullet from gun #1 is twice as heavy as the bullet from gun #2. Gun #1 weighs three times as much as gun #2. The ratio of the momentum imparted to gun #1 to that imparted to gun #2 is:
- A. 2:3
 - B. 3:2
 - C. 2:1
 - D. 3:1
 - E. 6:1
- ans: C

38. A 5-kg object can move along the x axis. It is subjected to a force \vec{F} in the positive x direction; a graph of F as a function of time t is shown below. Over the time the force is applied the change in the velocity of the object is:

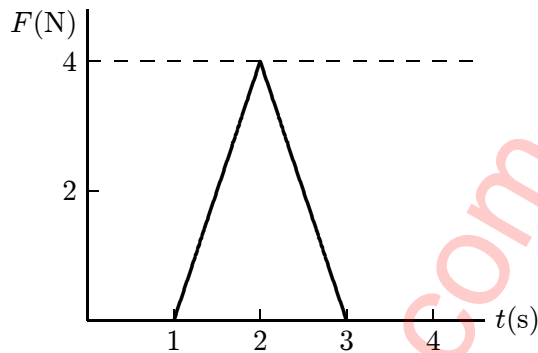

- A. 0.8 m/s
B. 1.1 m/s
C. 1.6 m/s
D. 2.3 m/s
E. 4.0 m/s
ans: A
39. Force:
A. equals the negative integral (with respect to distance) of the potential energy function
B. is the ability to do work
C. is the rate of change of doing work
D. equals the time rate of change of momentum
E. has dimensions of momentum multiplied by time
ans: D
40. Cart A, with a mass of 0.20 kg, travels on a horizontal air track at 3.0 m/s and hits cart B, which has a mass of 0.40 kg and is initially traveling away from A at 2.0 m/s. After the collision the center of mass of the two cart system has a speed of:
A. zero
B. 0.33 m/s
C. 2.3 m/s
D. 2.5 m/s
E. 5.0 m/s
ans: B

41. A 500-kg sack of coal is dropped on a 2000-kg railroad flatcar which was initially moving at 3 m/s as shown. After the sack rests on the flatcar, the speed of the flatcar is:



- A. 0.6 m/s
 B. 1.2 m/s
 C. 1.8 m/s
 D. 2.4 m/s
 E. 3.6 m/s
 ans: D
42. A cart loaded with sand slides forward along a horizontal frictionless track. As the cart moves, sand trickles out at a constant rate through a hole in the back of the cart. The acceleration of the cart is:
- A. constant and in the forward direction
 B. constant and in the backward direction
 C. variable and in the forward direction
 D. variable and in the backward direction
 E. zero
 ans: E
43. The thrust of a rocket is:
- A. a gravitational force acting on the rocket
 B. the force of the exiting fuel gases on the rocket
 C. any force that is external to the rocket-fuel system
 D. a force that arises from the reduction in mass of the rocket-fuel system
 E. none of the above
 ans: B:
44. At one instant of time a rocket is traveling in outer space at 2500 m/s and is exhausting fuel at a rate of 100 kg/s. If the speed of the fuel as it leaves the rocket is 1500 m/s, relative to the rocket, the thrust is:
- A. 0
 B. 1.0×10^5 N
 C. 1.5×10^5 N
 D. 2.9×10^5 N
 E. 2.5×10^5 N
 ans: C

45. A rocket exhausts fuel with a velocity of 1500 m/s , relative to the rocket. It starts from rest in outer space with fuel comprising 80 per cent of the total mass. When all the fuel has been exhausted its speed is:
- A. 3600 m/s
 - B. 2400 m/s
 - C. 1200 m/s
 - D. 880 m/s
 - E. 400 m/s
- ans: B

46. A 1000-kg space probe is motionless in space. To start moving, its main engine is fired for 5 s during which time it ejects exhaust gases at 5000 m/s . At the end of this process it is moving at 20 m/s . The approximate mass of the ejected gas is:

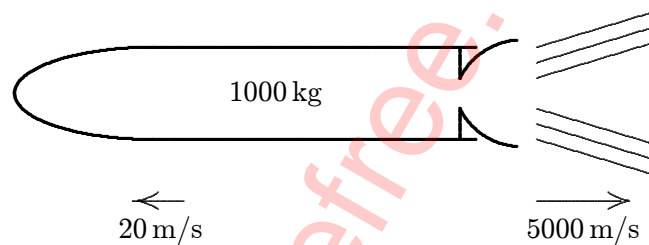

- A. 0.8 kg
 - B. 4 kg
 - C. 5 kg
 - D. 20 kg
 - E. 25 kg
- ans: B
47. The physical quantity “impulse” has the same dimensions as that of:
- A. force
 - B. power
 - C. energy
 - D. momentum
 - E. work
- ans: D
48. The law of conservation of momentum applies to a system of colliding objects only if:
- A. there is no change in kinetic energy of the system
 - B. the coefficient of restitution is one
 - C. the coefficient of restitution is zero
 - D. the net external impulse is zero
 - E. the collisions are all elastic
- ans: D

49. Sphere X, of mass 2 kg, is moving to the right at 10 m/s. Sphere Y, of mass 4 kg, is moving to the left at 10 m/s. The two spheres collide head-on. The magnitude of the impulse of X on Y is:
- A. twice the magnitude of the impulse of Y on X
 - B. half the magnitude of the impulse of Y on X
 - C. one-fourth the magnitude of the impulse of Y on X
 - D. four times the magnitude of the impulse of Y on X
 - E. the same as the magnitude of the impulse of Y on X
- ans: E
50. Two bodies of unequal mass, placed at rest on a frictionless surface, are acted on by equal horizontal forces for equal times. Just after these forces are removed, the body of greater mass will have:
- A. the greater speed
 - B. the greater acceleration
 - C. the smaller momentum
 - D. the greater momentum
 - E. the same momentum as the other body
- ans: E
51. A 0.2-kg rubber ball is dropped from the window of a building. It strikes the sidewalk below at 30 m/s and rebounds up at 20 m/s. The impulse on the ball during the collision is:
- A. 10 N · s upward
 - B. 10 N · s downward
 - C. 2.0 N · s upward
 - D. 2.0 N · s downward
 - E. 9.8 N · s upward
- ans: A
52. A 10-kg block of ice is at rest on a frictionless horizontal surface. A 1.0-N force is applied in an easterly direction for 1.0 s. During this time interval, the block:
- A. acquires a speed of 1 m/s
 - B. moves 10 cm
 - C. acquires a momentum of 1.0 kg · m/s
 - D. acquires a kinetic energy of 0.1 J
 - E. none of the above
- ans: C

53. A uniform narrow bar, resting on ice, is given a transverse horizontal impulse \vec{J} at one end as shown. The center of mass of the bar COM will then:

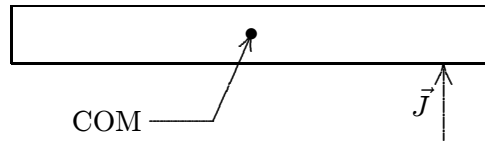

- A. remain at rest
B. move in a circle
C. move in a straight line
D. move in a parabola
E. move along some other curve
ans: C
54. What magnitude impulse will give a 2.0-kg object a momentum change of magnitude $+ 50 \text{ kg} \cdot \text{m/s}$?
- A. $+25 \text{ N} \cdot \text{s}$
B. $-25 \text{ N} \cdot \text{s}$
C. $+50 \text{ N} \cdot \text{s}$
D. $-50 \text{ N} \cdot \text{s}$
E. $+100 \text{ N} \cdot \text{s}$
ans: C
55. A student's life was saved in an automobile accident because an airbag expanded in front of his head. If the car had not been equipped with an airbag, the windshield would have stopped the motion of his head in a much shorter time. Compared to the windshield, the airbag:
- A. causes a much smaller change in momentum
B. exerts a much smaller impulse
C. causes a much smaller change in kinetic energy
D. exerts a much smaller force
E. does much more work
ans: D

56. A ball hits a wall and rebounds with the same speed, as diagramed below. The changes in the components of the momentum of the ball are:

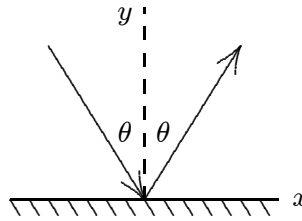

- A. $\Delta p_x > 0, \Delta p_y > 0$
- B. $\Delta p_x < 0, \Delta p_y > 0$
- C. $\Delta p_x = 0, \Delta p_y > 0$
- D. $\Delta p_x = 0, \Delta p_y < 0$
- E. $\Delta p_x > 0, \Delta p_y < 0$

ans: C

57. A golf ball of mass m is hit by a golf club so that the ball leaves the tee with speed v . The club is in contact with the ball for time T . The magnitude of the average force on the club on the ball during the time T is:

- A. mvT
- B. mv/T
- C. $(1/2)mv^2T$
- D. $mv^2/(2T)$
- E. $mT^2/(2v)$

ans: B

58. A 640-N acrobat falls 5.0 m from rest into a net. The net tosses him back up with the same speed he had just before he hit the net. The magnitude of the average upward force exerted on him by the net during this collision is:

- A. 32 N
- B. 64 N
- C. 320 N
- D. 640 N
- E. impossible to determine from given data

ans: E

59. Whenever an object strikes a stationary object of equal mass:

- A. the two objects cannot stick together
- B. the collision must be elastic
- C. the first object must stop
- D. momentum is not necessarily conserved
- E. none of the above

ans: E

60. For a two-body collision involving objects with different masses, a frame of reference which has the same velocity relative to the laboratory as does the center of mass of the two objects is:
- A. a frame for which the momentum of the incident object is zero
 - B. a frame for which the momentum of the target object is zero
 - C. a frame for which the average momentum of the two objects is zero
 - D. a frame for which the total momentum of the two objects is zero
 - E. none of the above
- ans: D
61. An inelastic collision is one in which:
- A. momentum is not conserved but kinetic energy is conserved
 - B. total mass is not conserved but momentum is conserved
 - C. neither kinetic energy nor momentum is conserved
 - D. momentum is conserved but kinetic energy is not conserved
 - E. the total impulse is equal to the change in kinetic energy
- ans: D
62. A 4.0-N puck is traveling at 3.0 m/s. It strikes a 8.0-N puck, which is stationary. The two pucks stick together. Their common final speed is:
- A. 1.0 m/s
 - B. 1.5 m/s
 - C. 2.0 m/s
 - D. 2.3 m/s
 - E. 3.0 m/s
- ans: A
63. A 3.00-g bullet traveling horizontally at 400 m/s hits a 3.00-kg wooden block, which is initially at rest on a smooth horizontal table. The bullet buries itself in the block without passing through. The speed of the block after the collision is:
- A. 1.33 m/s
 - B. 0.40 m/s
 - C. 12.0 m/s
 - D. 40.0 m/s
 - E. 160 m/s
- ans: B
64. A 2-kg cart, traveling on a horizontal air track with a speed of 3 m/s, collides with a stationary 4-kg cart. The carts stick together. The impulse exerted by one cart on the other has a magnitude of:
- A. 0
 - B. $4 \text{ N} \cdot \text{s}$
 - C. $6 \text{ N} \cdot \text{s}$
 - D. $9 \text{ N} \cdot \text{s}$
 - E. $12 \text{ N} \cdot \text{s}$
- ans: B

65. A 3-g bullet is fired horizontally into a 10-kg block of wood suspended by a rope from the ceiling. The block swings in an arc, rising 3 mm above its lowest position. The velocity of the bullet was:
- A. unknown since the heat generated in the collision was not given
 - B. 8.0×10^2 m/s
 - C. 24.0 m/s
 - D. 8.00 m/s
 - E. 2.4×10^4 m/s
- ans: B
66. A 3.0-kg and a 2.0-kg cart approach each other on a horizontal air track. They collide and stick together. After the collision their total kinetic energy is 40 J. The speed of their center of mass is:
- A. zero
 - B. 2.8 m/s
 - C. 4.0 m/s
 - D. 5.2 m/s
 - E. 6.3 m/s
- ans: C
67. Blocks A and B are moving toward each other. A has a mass of 2.0 kg and a velocity of 50 m/s, while B has a mass of 4.0 kg and a velocity of -25 m/s. They suffer a completely inelastic collision. The kinetic energy lost during the collision is:
- A. 0
 - B. 1250 J
 - C. 3750 J
 - D. 5000 J
 - E. 5600 J
- ans: C
68. For a completely inelastic two-body collision the kinetic energy retained by the objects is the same as:
- A. the total kinetic energy before the collision
 - B. the difference in the kinetic energies of the objects before the collision
 - C. $\frac{1}{2}Mv_{\text{com}}^2$, where M is the total mass and v_{com} is the velocity of the center of mass
 - D. the kinetic energy of the more massive body before the collision
 - E. the kinetic energy of the less massive body before the collision
- ans: C
69. A 75-kg man is riding in a 30-kg cart at 2.0 m/s. He jumps off in such a way as to land on the ground with no horizontal velocity. The resulting change in speed of the cart is:
- A. zero
 - B. 2.0 m/s
 - C. 3.0 m/s
 - D. 5.0 m/s
 - E. 7.0 m/s
- ans: D

70. An elastic collision is one in which:
- A. momentum is not conserved but kinetic energy is conserved
 - B. total mass is not conserved but momentum is conserved
 - C. kinetic energy and momentum are both conserved
 - D. momentum is conserved but kinetic energy is not conserved
 - E. the total impulse is equal to the change in kinetic energy
- ans: C
71. Object A strikes the stationary object B head-on in an elastic collision. The mass of A is fixed, you may choose the mass of B appropriately. Then:
- A. for B to have the greatest recoil speed, choose $m_B = m_A$
 - B. for B to have the greatest recoil momentum, choose $m_B \ll m_A$
 - C. for B to have the greatest recoil kinetic energy, choose $m_B \ll m_A$
 - D. for B to have the least recoil speed, choose $m_B = m_A$
 - E. for B to have the greatest recoil kinetic energy, choose $m_B = m_A$
- ans: E
72. Block A, with a mass of 2.0 kg, moves along the x axis with a velocity of 5.0 m/s in the positive x direction. It suffers an elastic collision with block B, initially at rest, and the blocks leave the collision along the x axis. If B is much more massive than A, the speed of A after the collision is:
- A. 0
 - B. +5.0 m/s
 - C. -5.0 m/s
 - D. +10 m/s
 - E. -10 m/s
- ans: C
73. A very massive object traveling at 10 m/s strikes a very light object, initially at rest, and the light object moves off in the direction of travel of the heavy object. If the collision is elastic, the speed of the lighter object is:
- A. 5.0 m/s
 - B. 10 m/s
 - C. 15 m/s
 - D. 20 m/s
 - E. Can't tell from the information given.
- ans: D
74. Sphere A has mass m and is moving with velocity v . It makes a head-on elastic collision with a stationary sphere B of mass $2m$. After the collision their speeds (v_A and v_B) are:
- A. 0, $v/2$
 - B. $-v/3$, $2v/3$
 - C. $-v$, v
 - D. $-2v/3$, $v/3$
 - E. none of these
- ans: B

75. Blocks A and B are moving toward each other along the x axis. A has a mass of 2.0 kg and a velocity of 50 m/s, while B has a mass of 4.0 kg and a velocity of -25 m/s. They suffer an elastic collision and move off along the x axis. The kinetic energy transferred from A to B during the collision is:
- A. 0
 - B. 2500 J
 - C. 5000 J
 - D. 7500 J
 - E. 10000 J

ans: A

76. When a particle suffers a head-on elastic collision with another particle, initially at rest, the greatest fraction of kinetic energy is transferred if:
- A. the incident particle is initially traveling very fast
 - B. the incident particle is traveling very slowly
 - C. the incident particle is much more massive than the target particle
 - D. the incident particle is much less massive than the target particle
 - E. the incident and target particle have the same mass

ans: E

77. Two objects, X and Y, are held at rest on a horizontal frictionless surface and a spring is compressed between them. The mass of X is $\frac{2}{5}$ times the mass of Y. Immediately after the spring is released, X has a kinetic energy of 50 J and Y has a kinetic energy of:
- A. 20 J
 - B. 8 J
 - C. 310 J
 - D. 125 J
 - E. 50 J

ans: D

78. Two carts (A and B), having spring bumpers, collide as shown. Cart A has a mass of 2 kg and is initially moving to the right. Cart B has a mass of 3 kg and is initially stationary. When the separation between the carts is a minimum:

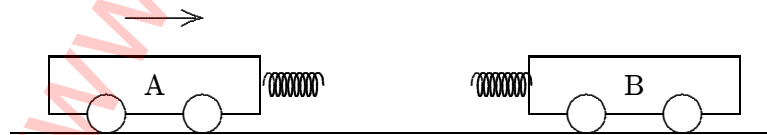

- A. cart B is still at rest
- B. cart A has come to rest
- C. the carts have the same momentum
- D. the carts have the same kinetic energy
- E. the kinetic energy of the system is at a minimum

ans: E

79. Two identical carts travel at 1 m/s in opposite directions on a common horizontal surface. They collide head-on and are reported to rebound, each with a speed of 2 m/s. Then:
- momentum was not conserved; therefore, the report must be false
 - if some other form of energy were changed to kinetic during the collision, the report could be true
 - if the collision were elastic, the report could be true
 - if friction were present, the report could be true
 - if the duration of the collision were long enough, the report could be true

ans: B

80. A block moves at 5.0 m/s in the positive x direction and hits an identical block, initially at rest. A small amount of gunpowder had been placed on one of the blocks. The explosion does not harm the blocks but it doubles their total kinetic energy. After the explosion the blocks move along the x axis and the incident block has a speed in of:

- 1.8 m/s
- 5.0 m/s
- 6.8 m/s
- 7.1 m/s
- 11.8 m/s

ans: A

81. A stream of gas consists of n molecules. Each molecule has mass m and speed v . The stream is reflected elastically from a rigid surface as shown. The magnitude of the change in the total momentum of the stream is:

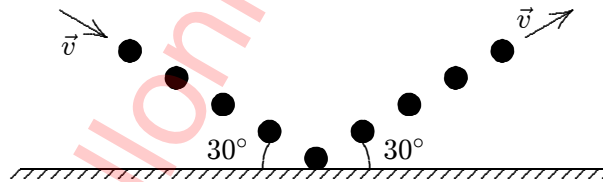

- $2mnv$
- $2mnv \sin 30^\circ$
- $mnv \sin 30^\circ$
- $mnv \cos 30^\circ$
- mnv

ans: B

Chapter 10: ROTATION

1. A radian is about:

- A. 25°
- B. 37°
- C. 45°
- D. 57°
- E. 90°

ans: D

2. One revolution is the same as:

- A. 1 rad
- B. 57 rad
- C. $\pi/2$ rad
- D. π rad
- E. 2π rad

ans: E

3. One revolution per minute is about:

- A. 0.0524 rad/s
- B. 0.105 rad/s
- C. 0.95 rad/s
- D. 1.57 rad/s
- E. 6.28 rad/s

ans: B

4. If a wheel turns with constant angular speed then:

- A. each point on its rim moves with constant velocity
- B. each point on its rim moves with constant acceleration
- C. the wheel turns through equal angles in equal times
- D. the angle through which the wheel turns in each second increases as time goes on
- E. the angle through which the wheel turns in each second decreases as time goes on

ans: C

5. If a wheel is turning at 3.0 rad/s, the time it takes to complete one revolution is about:

- A. 0.33 s
- B. 0.67 s
- C. 1.0 s
- D. 1.3 s
- E. 2.1 s

ans: E

6. If wheel turning at a constant rate completes 100 revolutions in 10 s its angular speed is:
- A. 0.31 rad/s
 - B. 0.63 rad/s
 - C. 10 rad/s
 - D. 31 rad/s
 - E. 63 rad/s

ans: E

7. The angular speed of the second hand of a watch is:

- A. $(\pi/1800)$ rad/s
- B. $(\pi/60)$ m/s
- C. $(\pi/30)$ m/s
- D. (2π) m/s
- E. (60) m/s

ans: C

8. The angular speed of the minute hand of a watch is:

- A. $(60/\pi)$ m/s
- B. $(1800/\pi)$ m/s
- C. (π) m/s
- D. $(\pi/1800)$ m/s
- E. $(\pi/60)$ m/s

ans: D

9. A flywheel is initially rotating at 20 rad/s and has a constant angular acceleration. After 9.0 s it has rotated through 450 rad. Its angular acceleration is:

- A. 3.3 rad/s
- B. 4.4 rad/s
- C. 5.6 rad/s
- D. 6.7 rad/s
- E. 11 rad/s

ans: D

10. Ten seconds after an electric fan is turned on, the fan rotates at 300 rev/min. Its average angular acceleration is:

- A. 3.14 rad/s^2
- B. 30 rad/s^2
- C. 30 rev/s^2
- D. 50 rev/min^2
- E. 1800 rev/s^2

ans: A

11. A wheel rotates with a constant angular acceleration of $\pi \text{ rad/s}^2$. During a certain time interval its angular displacement is $\pi \text{ rad}$. At the end of the interval its angular velocity is $2\pi \text{ rad/s}$. Its angular velocity at the beginning of the interval is:
- A. zero
 - B. 1 rad/s
 - C. $\pi \text{ rad/s}$
 - D. $\pi\sqrt{2} \text{ rad/s}$
 - E. $2\pi \text{ rad/s}$
- ans: D
12. A flywheel rotating at 12 rev/s is brought to rest in 6 s . The magnitude of the average angular acceleration in rad/s^2 of the wheel during this process is:
- A. $1/\pi$
 - B. 2
 - C. 4
 - D. 4π
 - E. 72
- ans: D
13. A phonograph turntable, initially rotating at 0.75 rev/s , slows down and stops in 30 s . The magnitude of its average angular acceleration in rad/s^2 for this process is:
- A. 1.5
 - B. 1.5π
 - C. $\pi/40$
 - D. $\pi/20$
 - E. 0.75
- ans: D
14. The angular velocity of a rotating wheel increases by 2 rev/s every minute. The angular acceleration in rad/s^2 of this wheel is:
- A. $4\pi^2$
 - B. 2π
 - C. $1/30$
 - D. $\pi/15$
 - E. 4π
- ans: D
15. A wheel initially has an angular velocity of 18 rad/s . It has a constant angular acceleration of 2.0 rad/s^2 and is slowing at first. What time elapses before its angular velocity is 18 rad/s in the direction opposite to its initial angular velocity?
- A. 3.0 s
 - B. 6.0 s
 - C. 9.0 s
 - D. 18 s
 - E. 36 s
- ans: D

16. A wheel initially has an angular velocity of 36 rad/s but after 6.0 s its angular velocity is 24 rad/s . If its angular acceleration is constant its value is:
- A. 2.0 rad/s^2
 - B. -2.0 rad/s^2
 - C. 3.0 rad/s^2
 - D. -3.0 rad/s^2
 - E. 6.0 rad/s^2
- ans: B
17. A wheel initially has an angular velocity of -36 rad/s but after 6.0 s its angular velocity is -24 rad/s . If its angular acceleration is constant the value is:
- A. 2.0 rad/s^2
 - B. -2.0 rad/s^2
 - C. 3.0 rad/s^2
 - D. -3.0 rad/s^2
 - E. -6.0 rad/s^2
- ans: A
18. A wheel initially has an angular velocity of 18 rad/s but it is slowing at a rate of 2.0 rad/s^2 . By the time it stops it will have turned through:
- A. 81 rad
 - B. 160 rad
 - C. 245 rad
 - D. 330 rad
 - E. 410 rad
- ans: A
19. A wheel starts from rest and has an angular acceleration of 4.0 rad/s^2 . When it has made 10 rev its angular velocity is:
- A. 16 rad/s
 - B. 22 rad/s
 - C. 32 rad/s
 - D. 250 rad/s
 - E. 500 rad/s
- ans: B
20. A wheel starts from rest and has an angular acceleration of 4.0 rad/s^2 . The time it takes to make 10 rev is:
- A. 0.50 s
 - B. 0.71 s
 - C. 2.2 s
 - D. 2.8 s
 - E. 5.6 s
- ans: E

21. A wheel starts from rest and has an angular acceleration that is given by $\alpha(t) = (6 \text{ rad/s}^4)t^2$. The angle through which it turns in time t is given by:
- A. $[(1/8)t^4] \text{ rad}$
 - B. $[(1/4)t^4] \text{ rad}$
 - C. $[(1/2)t^4] \text{ rad}$
 - D. $(t^4) \text{ rad}$
 - E. 12 rad
- ans: C
22. A wheel starts from rest and has an angular acceleration that is given by $\alpha(t) = (6.0 \text{ rad/s}^4)t^2$. The time it takes to make 10 rev is:
- A. 2.8 s
 - B. 3.3 s
 - C. 4.0 s
 - D. 4.7 s
 - E. 5.3 s
- ans: B
23. A wheel starts from rest and has an angular acceleration that is given by $\alpha(t) = (6.0 \text{ rad/s}^4)t^2$. After it has turned through 10 rev its angular velocity is:
- A. 63 rad/s
 - B. 75 rad/s
 - C. 89 rad/s
 - D. 130 rad/s
 - E. 210 rad/s
- ans: B
24. A wheel is spinning at 27 rad/s but is slowing with an angular acceleration that has a magnitude given by $(3.0 \text{ rad/s}^4)t^2$. It stops in a time of:
- A. 1.7 s
 - B. 2.6 s
 - C. 3.0 s
 - D. 4.4 s
 - E. 7.3 s
- ans: C
25. If the angular velocity vector of a spinning body points out of the page then, when viewed from above the page, the body is spinning:
- A. clockwise about an axis that is perpendicular to the page
 - B. counterclockwise about an axis that is perpendicular to the page
 - C. about an axis that is parallel to the page
 - D. about an axis that is changing orientation
 - E. about an axis that is getting longer
- ans: B

26. The angular velocity vector of a spinning body points out of the page. If the angular acceleration vector points into the page then:
- A. the body is slowing down
 - B. the body is speeding up
 - C. the body is starting to turn in the opposite direction
 - D. the axis of rotation is changing orientation
 - E. none of the above

ans: A

27. A child, riding on a large merry-go-round, travels a distance of 3000 m in a circle of diameter 40 m. The total angle through which she revolves is:
- A. 50 rad
 - B. 75 rad
 - C. 150 rad
 - D. 314 rad
 - E. none of these

ans: C

28. The figure shows a cylinder of radius 0.7 m rotating about its axis at 10 rad/s. The speed of the point P is:



- A. 7.0 m/s
- B. 14π rad/s
- C. 7.0π rad/s
- D. 0.70 m/s
- E. none of these

ans: A

29. The fan shown has been turned on and is now slowing as it rotates clockwise. The direction of the acceleration of the point X on the fan tip could be:

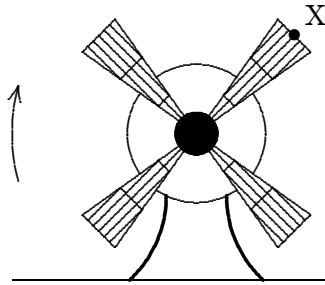

- A. ↙
 B. ↘
 C. ↓
 D. ←
 E. →

ans: D

30. A wheel of diameter 3.0 cm has a 4.0-m cord wrapped around its periphery. Starting from rest, the wheel is given a constant angular acceleration of 2.0 rad/s^2 . The cord will unwind in:

- A. 0.82 s
 B. 2.0 s
 C. 8.0 s
 D. 16 s
 E. 130 s

ans: D

31. A particle moves in a circular path of radius 0.10 m with a constant angular speed of 5 rev/s. The acceleration of the particle is:

- A. $0.10\pi \text{ m/s}^2$
 B. 0.50 m/s^2
 C. $500\pi \text{ m/s}^2$
 D. $1000\pi^2 \text{ m/s}^2$
 E. $10\pi^2 \text{ m/s}^2$

ans: E

32. A car travels north at constant velocity. It goes over a piece of mud, which sticks to the tire. The initial acceleration of the mud, as it leaves the ground, is:

- A. vertically upward
 B. horizontally to the north
 C. horizontally to the south
 D. zero
 E. upward and forward at 45° to the horizontal

ans: A

33. Wrapping paper is being from a 5.0-cm radius tube, free to rotate on its axis. If it is pulled at the constant rate of 10 cm/s and does not slip on the tube, the angular velocity of the tube is:
- A. 2.0 rad/s
 - B. 5.0 rad/s
 - C. 10 rad/s
 - D. 25 rad/s
 - E. 50 rad/s
- ans: A
34. String is wrapped around the periphery of a 5.0-cm radius cylinder, free to rotate on its axis. The string is pulled straight out at a constant rate of 10 cm/s and does not slip on the cylinder. As each small segment of string leaves the cylinder, its acceleration changes by:
- A. 0
 - B. 0.010 m/s^2
 - C. 0.020 m/s^2
 - D. 0.10 m/s^2
 - E. 0.20 m/s^2
- ans: E
35. A flywheel of diameter 1.2 m has a constant angular acceleration of 5.0 rad/s^2 . The tangential acceleration of a point on its rim is:
- A. 5.0 rad/s^2
 - B. 3.0 m/s^2
 - C. 5.0 m/s^2
 - D. 6.0 m/s^2
 - E. 12 m/s^2
- ans: B
36. For a wheel spinning with constant angular acceleration on an axis through its center, the ratio of the speed of a point on the rim to the speed of a point halfway between the center and the rim is:
- A. 1
 - B. 2
 - C. $1/2$
 - D. 4
 - E. $1/4$
- ans: B
37. For a wheel spinning on an axis through its center, the ratio of the tangential acceleration of a point on the rim to the tangential acceleration of a point halfway between the center and the rim is:
- A. 1
 - B. 2
 - C. $1/2$
 - D. 4
 - E. $1/4$
- ans: B

38. For a wheel spinning on an axis through its center, the ratio of the radial acceleration of a point on the rim to the radial acceleration of a point halfway between the center and the rim is:
- A. 1
 - B. 2
 - C. $1/2$
 - D. 4
 - E. $1/4$
- ans: B
39. Two wheels are identical but wheel B is spinning with twice the angular speed of wheel A. The ratio of the magnitude of the radial acceleration of a point on the rim of B to the magnitude of the radial acceleration of a point on the rim of A is:
- A. 1
 - B. 2
 - C. $1/2$
 - D. 4
 - E. $1/4$
- ans: D
40. A wheel starts from rest and spins with a constant angular acceleration. As time goes on the acceleration vector for a point on the rim:
- A. decreases in magnitude and becomes more nearly tangent to the rim
 - B. decreases in magnitude and becomes more nearly radial
 - C. increases in magnitude and becomes more nearly tangent to the rim
 - D. increases in magnitude and becomes more nearly radial
 - E. increases in magnitude but retains the same angle with the tangent to the rim
- ans: D
41. The magnitude of the acceleration of a point on a spinning wheel is increased by a factor of 4 if:
- A. the magnitudes of the angular velocity and the angular acceleration are each multiplied by a factor of 4
 - B. the magnitude of the angular velocity is multiplied by a factor of 4 and the angular acceleration is not changed
 - C. the magnitudes of the angular velocity and the angular acceleration are each multiplied by a factor of 2
 - D. the magnitude of the angular velocity is multiplied by a factor of 2 and the angular acceleration is not changed
 - E. the magnitude of the angular velocity is multiplied by a factor of 2 and the magnitude of the angular acceleration is multiplied by a factor of 4
- ans: E

42. Three identical balls are tied by light strings to the same rod and rotate around it, as shown below. Rank the balls according to their rotational inertia, least to greatest.

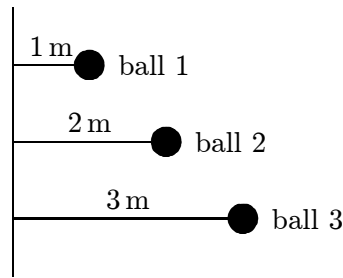

- A. 1, 2, 3
 B. 3, 2, 1
 C. 3, then 1 and 2 tie
 D. 1, 3, 2
 E. All are the same

ans: A

43. Four identical particles, each with mass m , are arranged in the x, y plane as shown. They are connected by light sticks to form a rigid body. If $m = 2.0\text{ kg}$ and $a = 1.0\text{ m}$, the rotational inertia of this array about the y axis is:

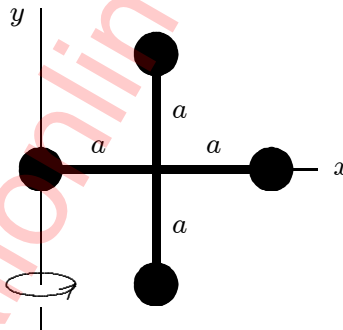

- A. $4.0\text{ kg} \cdot \text{m}^2$
 B. $12\text{ kg} \cdot \text{m}^2$
 C. $9.6\text{ kg} \cdot \text{m}^2$
 D. $4.8\text{ kg} \cdot \text{m}^2$
 E. none of these

ans: B

44. Three identical balls, with masses of M , $2M$, and $3M$, are fastened to a massless rod of length L as shown. The rotational inertia about the left end of the rod is:

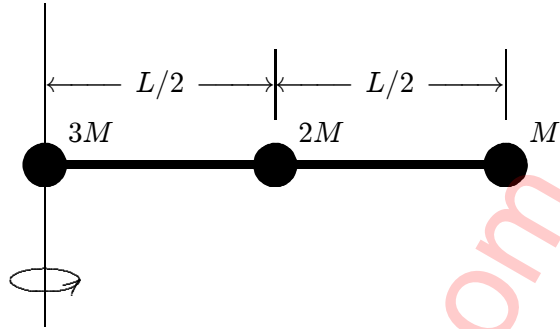

- A. $ML^2/2$
 B. ML^2
 C. $3ML^2/2$
 D. $6ML^2$
 E. $3ML^2/4$

ans: E

45. The rotational inertia of a thin cylindrical shell of mass M , radius R , and length L about its central axis (X-X') is:

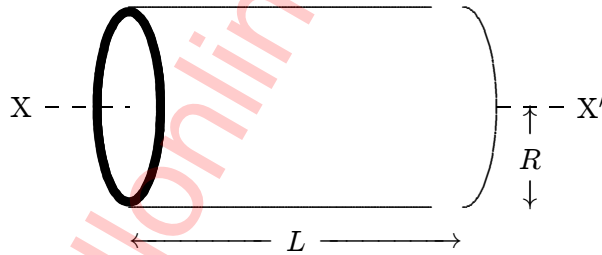

- A. $MR^2/2$
 B. $ML^2/2$
 C. ML^2
 D. MR^2
 E. none of these

ans: D

46. The rotational inertia of a wheel about its axle does not depend upon its:

- A. diameter
 B. mass
 C. distribution of mass
 D. speed of rotation
 E. material composition

ans: D

47. Consider four objects, each having the same mass and the same radius:
1. a solid sphere
 2. a hollow sphere
 3. a flat disk in the x, y plane
 4. a hoop in the x, y plane

The order of increasing rotational inertia about an axis through the center of mass and parallel to the z axis is:

- A. 1, 2, 3, 4
- B. 4, 3, 2, 1
- C. 1, 3, 2, 4
- D. 4, 2, 3, 1
- E. 3, 1, 2, 4

ans: C

48. A and B are two solid cylinders made of aluminum. Their dimensions are shown. The ratio of the rotational inertia of B to that of A about the common axis X-X' is:

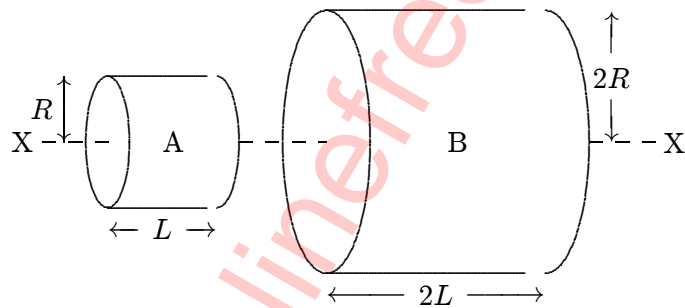

- A. 2
- B. 4
- C. 8
- D. 16
- E. 32

ans: E

49. Two uniform circular disks having the same mass and the same thickness are made from different materials. The disk with the smaller rotational inertia is:
- A. the one made from the more dense material
 - B. the one made from the less dense material
 - C. neither — both rotational inertias are the same
 - D. the disk with the larger angular velocity
 - E. the disk with the larger torque

ans: A

50. A uniform solid cylinder made of lead has the same mass and the same length as a uniform solid cylinder made of wood. The rotational inertia of the lead cylinder compared to the wooden one is:
- A. greater
 - B. less
 - C. same
 - D. unknown unless the radii are given
 - E. unknown unless both the masses and the radii are given
- ans: B
51. To increase the rotational inertia of a solid disk about its axis without changing its mass:
- A. drill holes near the rim and put the material near the axis
 - B. drill holes near the axis and put the material near the rim
 - C. drill holes at points on a circle near the rim and put the material at points between the holes
 - D. drill holes at points on a circle near the axis and put the material at points between the holes
 - E. do none of the above (the rotational inertia cannot be changed without changing the mass)
- ans: B
52. The rotational inertia of a disk about its axis is $0.70 \text{ kg} \cdot \text{m}^2$. When a 2.0-kg weight is added to its rim, 0.40 m from the axis, the rotational inertia becomes:
- A. $0.38 \text{ kg} \cdot \text{m}^2$
 - B. $0.54 \text{ kg} \cdot \text{m}^2$
 - C. $0.70 \text{ kg} \cdot \text{m}^2$
 - D. $0.86 \text{ kg} \cdot \text{m}^2$
 - E. $1.0 \text{ kg} \cdot \text{m}^2$
- ans: E
53. When a thin uniform stick of mass M and length L is pivoted about its midpoint, its rotational inertia is $ML^2/12$. When pivoted about a parallel axis through one end, its rotational inertia is:
- A. $ML^2/12$
 - B. $ML^2/6$
 - C. $ML^2/3$
 - D. $7ML^2/12$
 - E. $13ML^2/12$
- ans: C
54. The rotational inertia of a solid uniform sphere about a diameter is $(2/5)MR^2$, where M is its mass and R is its radius. If the sphere is pivoted about an axis that is tangent to its surface, its rotational inertia is:
- A. MR^2
 - B. $(2/5)MR^2$
 - C. $(3/5)MR^2$
 - D. $(5/2)MR^2$
 - E. $(7/5)MR^2$
- ans: E

55. A solid uniform sphere of radius R and mass M has a rotational inertia about a diameter that is given by $(2/5)MR^2$. A light string of length $3R$ is attached to the surface and used to suspend the sphere from the ceiling. Its rotational inertia about the point of attachment at the ceiling is:
- $(2/5)MR^2$
 - $9MR^2$
 - $16MR^2$
 - $(47/5)MR^2$
 - $(82/5)MR^2$

ans: E

56. A force with a given magnitude is to be applied to a wheel. The torque can be maximized by:
- applying the force near the axle, radially outward from the axle
 - applying the force near the rim, radially outward from the axle
 - applying the force near the axle, parallel to a tangent to the wheel
 - applying the force at the rim, tangent to the rim
 - applying the force at the rim, at 45° to the tangent

ans: D

57. The meter stick shown below rotates about an axis through the point marked \bullet , 20 cm from one end. Five forces act on the stick: one at each end, one at the pivot point, and two 40 cm from one end, as shown. The magnitudes of the forces are all the same. Rank the forces according to the magnitudes of the torques they produce about the pivot point, least to greatest.

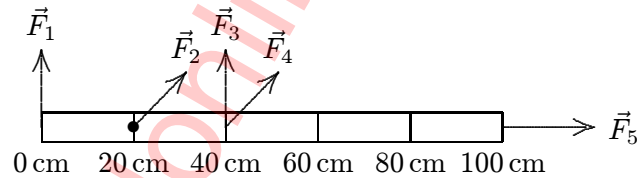

- $\vec{F}_1, \vec{F}_2, \vec{F}_3, \vec{F}_4, \vec{F}_5$
- \vec{F}_1 and \vec{F}_2 tie, then $\vec{F}_3, \vec{F}_4, \vec{F}_5$
- \vec{F}_2 and \vec{F}_5 tie, then $\vec{F}_4, \vec{F}_1, \vec{F}_3$
- $\vec{F}_2, \vec{F}_5, \vec{F}_1$ and \vec{F}_3 tie, then \vec{F}_4
- \vec{F}_2 and \vec{F}_5 tie, then \vec{F}_4 , then \vec{F}_1 and \vec{F}_3 tie

ans: E

58. A rod is pivoted about its center. A 5-N force is applied 4 m from the pivot and another 5-N force is applied 2 m from the pivot, as shown. The magnitude of the total torque about the pivot (in N·m) is:

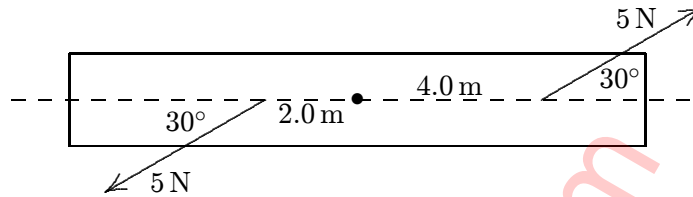

- A. 0
 B. 5
 C. 8.7
 D. 15
 E. 26

ans: D

59. $\tau = I\alpha$ for an object rotating about a fixed axis, where τ is the net torque acting on it, I is its rotational inertia, and α is its angular acceleration. This expression:
- A. is the definition of torque
 B. is the definition of rotational inertia
 C. is the definition of angular acceleration
 D. follows directly from Newton's second law
 E. depends on a principle of physics that is unrelated to Newton's second law

ans: D

60. A meter stick on a horizontal frictionless table top is pivoted at the 80-cm mark. It is initially at rest. A horizontal force \vec{F}_1 is applied perpendicularly to the end of the stick at 0 cm, as shown. A second horizontal force \vec{F}_2 (not shown) is applied at the 100-cm end of the stick. If the stick does not rotate:

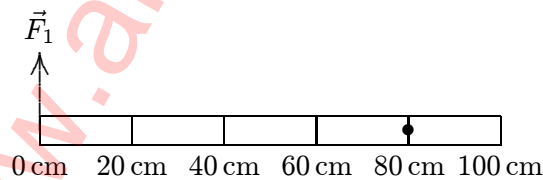

- A. $|\vec{F}_2| > |\vec{F}_1|$ for all orientations of \vec{F}_2
 B. $|\vec{F}_2| < |\vec{F}_1|$ for all orientations of \vec{F}_2
 C. $|\vec{F}_2| = |\vec{F}_1|$ for all orientations of \vec{F}_2
 D. $|\vec{F}_2| > |\vec{F}_1|$ for some orientations of \vec{F}_2 and $|\vec{F}_2| < |\vec{F}_1|$ for others
 E. $|\vec{F}_2| > |\vec{F}_1|$ for some orientations of \vec{F}_2 and $|\vec{F}_2| = |\vec{F}_1|$ for others

ans: A

61. A uniform disk, a thin hoop, and a uniform sphere, all with the same mass and same outer radius, are each free to rotate about a fixed axis through its center. Assume the hoop is connected to the rotation axis by light spokes. With the objects starting from rest, identical forces are simultaneously applied to the rims, as shown. Rank the objects according to their angular accelerations, least to greatest.

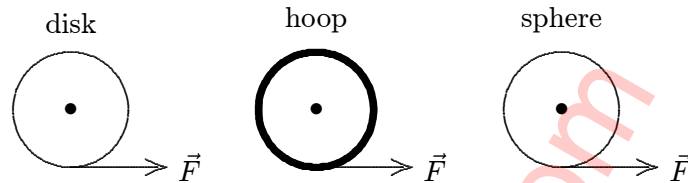

- A. disk, hoop, sphere
 B. hoop, disk, sphere
 C. hoop, sphere, disk
 D. hoop, disk, sphere
 E. sphere, disk, hoop
 ans: D
62. A disk is free to rotate on a fixed axis. A force of given magnitude F , in the plane of the disk, is to be applied. Of the following alternatives the greatest angular acceleration is obtained if the force is:
- A. applied tangentially halfway between the axis and the rim
 B. applied tangentially at the rim
 C. applied radially halfway between the axis and the rim
 D. applied radially at the rim
 E. applied at the rim but neither radially nor tangentially
 ans: B
63. A cylinder is 0.10 m in radius and 0.20 m in length. Its rotational inertia, about the cylinder axis on which it is mounted, is $0.020 \text{ kg} \cdot \text{m}^2$. A string is wound around the cylinder and pulled with a force of 1.0 N. The angular acceleration of the cylinder is:
- A. 2.5 rad/s^2
 B. 5.0 rad/s^2
 C. 10 rad/s^2
 D. 15 rad/s^2
 E. 20 rad/s^2
 ans: B

64. A disk with a rotational inertia of $2.0 \text{ kg} \cdot \text{m}^2$ and a radius of 0.40 m rotates on a frictionless fixed axis perpendicular to the disk faces and through its center. A force of 5.0 N is applied tangentially to the rim. The angular acceleration of the disk is:
- A. 0.40 rad/s^2
 - B. 0.60 rad/s^2
 - C. 1.0 rad/s^2
 - D. 2.5 rad/s^2
 - E. 10 rad/s^2
- ans: C
65. A disk with a rotational inertia of $5.0 \text{ kg} \cdot \text{m}^2$ and a radius of 0.25 m rotates on a frictionless fixed axis perpendicular to the disk and through its center. A force of 8.0 N is applied along the rotation axis. The angular acceleration of the disk is:
- A. 0
 - B. 0.40 rad/s^2
 - C. 0.60 rad/s^2
 - D. 1.0 rad/s^2
 - E. 2.5 rad/s^2
- ans: A
66. A disk with a rotational inertia of $5.0 \text{ kg} \cdot \text{m}^2$ and a radius of 0.25 m rotates on a frictionless fixed axis perpendicular to the disk and through its center. A force of 8.0 N is applied tangentially to the rim. If the disk starts at rest, then after it has turned through half a revolution its angular velocity is:
- A. 0.57 rad/s
 - B. 0.64 rad/s
 - C. 0.80 rad/s
 - D. 1.6 rad/s
 - E. 3.2 rad/s
- ans: D
67. A thin circular hoop of mass 1.0 kg and radius 2.0 m is rotating about an axis through its center and perpendicular to its plane. It is slowing down at the rate of 7.0 rad/s^2 . The net torque acting on it is:
- A. $7.0 \text{ N} \cdot \text{m}$
 - B. $14.0 \text{ N} \cdot \text{m}$
 - C. $28.0 \text{ N} \cdot \text{m}$
 - D. $44.0 \text{ N} \cdot \text{m}$
 - E. none of these
- ans: C

68. A certain wheel has a rotational inertia of $12 \text{ kg} \cdot \text{m}^2$. As it turns through 5.0 rev its angular velocity increases from 5.0 rad/s to 6.0 rad/s . If the net torque is constant its value is:
- A. $0.016 \text{ N} \cdot \text{m}$
 - B. $0.18 \text{ N} \cdot \text{m}$
 - C. $0.57 \text{ N} \cdot \text{m}$
 - D. $2.1 \text{ N} \cdot \text{m}$
 - E. $3.6 \text{ N} \cdot \text{m}$
- ans: D

69. A 16-kg block is attached to a cord that is wrapped around the rim of a flywheel of diameter 0.40 m and hangs vertically, as shown. The rotational inertia of the flywheel is $0.50 \text{ kg} \cdot \text{m}^2$. When the block is released and the cord unwinds, the acceleration of the block is:

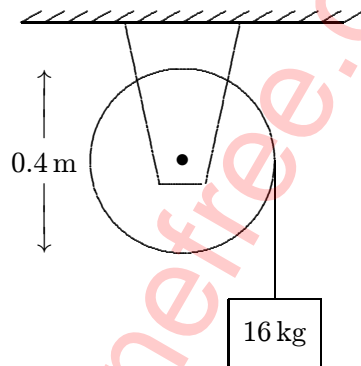

- A. $0.15g$
 - B. $0.56g$
 - C. $0.84g$
 - D. g
 - E. $1.3g$
- ans: B
70. A 8.0-cm radius disk with a rotational inertia of $0.12 \text{ kg} \cdot \text{m}^2$ is free to rotate on a horizontal axis. A string is fastened to the surface of the disk and a 10-kg mass hangs from the other end. The mass is raised by using a crank to apply a $9.0\text{-N}\cdot\text{m}$ torque to the disk. The acceleration of the mass is:
- A. 0.50 m/s^2
 - B. 1.7 m/s^2
 - C. 6.2 m/s^2
 - D. 12 m/s^2
 - E. 20 m/s^2
- ans: A

71. A 0.70-kg disk with a rotational inertia given by $MR^2/2$ is free to rotate on a fixed horizontal axis suspended from the ceiling. A string is wrapped around the disk and a 2.0-kg mass hangs from the free end. If the string does not slip, then as the mass falls and the cylinder rotates, the suspension holding the cylinder pulls up on the cylinder with a force of:
- 6.9 N
 - 9.8 N
 - 16 N
 - 26 N
 - 29 N

ans: B

72. A small disk of radius R_1 is mounted coaxially with a larger disk of radius R_2 . The disks are securely fastened to each other and the combination is free to rotate on a fixed axle that is perpendicular to a horizontal frictionless table top, as shown in the overhead view below. The rotational inertia of the combination is I . A string is wrapped around the larger disk and attached to a block of mass m , on the table. Another string is wrapped around the smaller disk and is pulled with a force \vec{F} as shown. The acceleration of the block is:

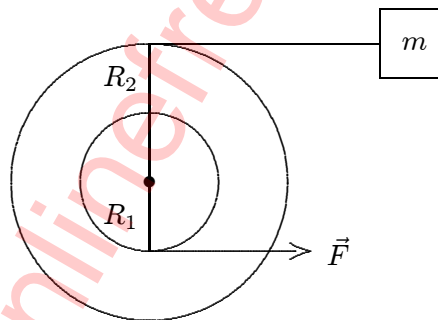

- $R_1 F / m R_2$
- $R_1 R_2 F / (I - m R_2^2)$
- $R_1 R_2 F / (I + m R_2^2)$
- $R_1 R_2 F / (I - m R_1 R_2)$
- $R_1 R_2 F / (I + m R_1 R_2)$

ans: C

73. A small disk of radius R_1 is fastened coaxially to a larger disk of radius R_2 . The combination is free to rotate on a fixed axle, which is perpendicular to a horizontal frictionless table top, as shown in the overhead view below. The rotational inertia of the combination is I . A string is wrapped around the larger disk and attached to a block of mass m , on the table. Another string is wrapped around the smaller disk and is pulled with a force \vec{F} as shown. The tension in the string pulling the block is:

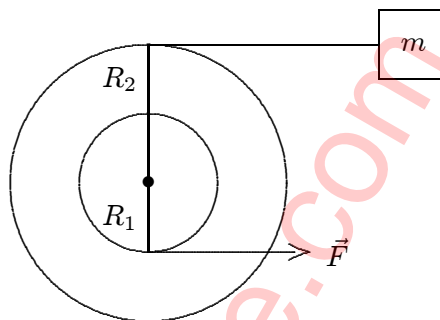

- A. $R_1 F / R_2$
 B. $m R_1 R_2 F / (I - m R_2^2)$
 C. $m R_1 R_2 F / (I + m R_2^2)$
 D. $m R_1 R_2 F / (I - m R_1 R_2)$
 E. $m R_1 R_2 F / (I + m R_1 R_2)$
 ans: C
74. A block is attached to each end of a rope that passes over a pulley suspended from the ceiling. The blocks do not have the same mass. If the rope does not slip on the pulley, then at any instant after the blocks start moving, the rope:
- A. pulls on both blocks, but exerts a greater force on the heavier block
 B. pulls on both blocks, but exerts a greater force on the lighter block
 C. pulls on both blocks and exerts the same magnitude force on both
 D. does not pull on either block
 E. pulls only on the lighter block
 ans: A
75. A pulley with a radius of 3.0 cm and a rotational inertia of $4.5 \times 10^{-3} \text{ kg} \cdot \text{m}^2$ is suspended from the ceiling. A rope passes over it with a 2.0-kg block attached to one end and a 4.0-kg block attached to the other. The rope does not slip on the pulley. When the speed of the heavier block is 2.0 m/s the kinetic energy of the pulley is:
- A. 0.15 J
 B. 0.30 J
 C. 1.0 J
 D. 10 J
 E. 20 J
 ans: D

76. A pulley with a radius of 3.0 cm and a rotational inertia of $4.5 \times 10^{-3} \text{ kg} \cdot \text{m}^2$ is suspended from the ceiling. A rope passes over it with a 2.0-kg block attached to one end and a 4.0-kg block attached to the other. The rope does not slip on the pulley. At any instant after the blocks start moving, the object with the greatest kinetic energy is:
- A. the heavier block
 - B. the lighter block
 - C. the pulley
 - D. either block (the two blocks have the same kinetic energy)
 - E. none (all three objects have the same kinetic energy)
- ans: C
77. A disk with a rotational inertia of $5.0 \text{ kg} \cdot \text{m}^2$ and a radius of 0.25 m rotates on a fixed axis perpendicular to the disk and through its center. A force of 2.0 N is applied tangentially to the rim. As the disk turns through half a revolution the work done by the force is:
- A. 1.6 J
 - B. 2.5 J
 - C. 6.3 J
 - D. 10 J
 - E. 40 J
- ans: A
78. A circular saw is powered by a motor. When the saw is used to cut wood, the wood exerts a torque of $0.80 \text{ N} \cdot \text{m}$ on the saw blade. If the blade rotates with a constant angular velocity of 20 rad/s the work done on the blade by the motor in 1.0 min is:
- A. 0
 - B. 480 J
 - C. 960 J
 - D. 1400 J
 - E. 1800 J
- ans: C
79. A disk has a rotational inertia of $6.0 \text{ kg} \cdot \text{m}^2$ and a constant angular acceleration of 2.0 rad/s^2 . If it starts from rest the work done during the first 5.0 s by the net torque acting on it is:
- A. 0
 - B. 30 J
 - C. 60 J
 - D. 300 J
 - E. 600 J
- ans: D
80. A disk starts from rest and rotates around a fixed axis, subject to a constant net torque. The work done by the torque during the second 5 s is _____ as the work done during the first 5 s.
- A. the same
 - B. twice as much
 - C. half as much
 - D. four times as much
 - E. one-fourth as much
- ans: D

81. A disk starts from rest and rotates about a fixed axis, subject to a constant net torque. The work done by the torque during the second revolution is _____ as the work done during the first revolution.
- A. the same
 - B. twice as much
 - C. half as much
 - D. four times as much
 - E. one-fourth as much

ans: A

www.allonlinefree.com

Chapter 11: ROLLING, TORQUE, AND ANGULAR MOMENTUM

1. A wheel rolls without sliding along a horizontal road as shown. The velocity of the center of the wheel is represented by \rightarrow . Point P is painted on the rim of the wheel. The instantaneous velocity of point P is:

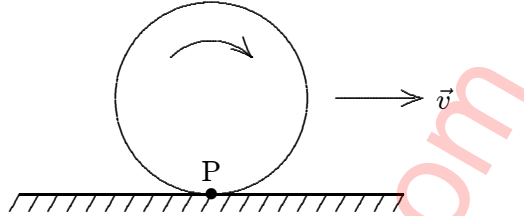

- A. \rightarrow
- B. \leftarrow
- C. \uparrow
- D. \nearrow
- E. zero

ans: E

2. A wheel of radius 0.5 m rolls without sliding on a horizontal surface as shown. Starting from rest, the wheel moves with constant angular acceleration 6 rad/s^2 . The distance traveled by the center of the wheel from $t = 0$ to $t = 3 \text{ s}$ is:

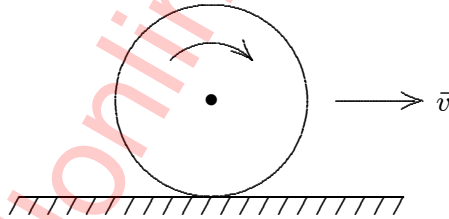

- A. zero
- B. 27 m
- C. 13.5 m
- D. 18 m
- E. none of these

ans: C

3. Two wheels roll side-by-side without sliding, at the same speed. The radius of wheel 2 is twice the radius of wheel 1. The angular velocity of wheel 2 is:
- A. twice the angular velocity of wheel 1
 - B. the same as the angular velocity of wheel 1
 - C. half the angular velocity of wheel 1
 - D. more than twice the angular velocity of wheel 1
 - E. less than half the angular velocity of wheel 1

ans: C

4. A forward force on the axle accelerates a rolling wheel on a horizontal surface. If the wheel does not slide the frictional force of the surface on the wheel is:
- A. zero
 - B. in the forward direction
 - C. in the backward direction
 - D. in the upward direction
 - E. in the downward direction

ans: D

5. When the speed of a rear-drive car is increasing on a horizontal road the direction of the frictional force on the tires is:
- A. forward for all tires
 - B. backward for all tires
 - C. forward for the front tires and backward for the rear tires
 - D. backward for the front tires and forward for the rear tires
 - E. zero

ans: D

6. A solid wheel with mass M , radius R , and rotational inertia $MR^2/2$, rolls without sliding on a horizontal surface. A horizontal force F is applied to the axle and the center of mass has an acceleration a . The magnitudes of the applied force F and the frictional force f of the surface, respectively, are:
- A. $F = Ma, f = 0$
 - B. $F = Ma, f = Ma/2$
 - C. $F = 2Ma, f = Ma$
 - D. $F = 2Ma, f = Ma/2$
 - E. $F = 3Ma/2, f = Ma/2$

ans: E

7. The coefficient of static friction between a certain cylinder and a horizontal floor is 0.40. If the rotational inertia of the cylinder about its symmetry axis is given by $I = (1/2)MR^2$, then the magnitude of the maximum acceleration the cylinder can have without sliding is:
- A. $0.1g$
 - B. $0.2g$
 - C. $0.4g$
 - D. $0.8g$
 - E. g

ans: D

8. A thin-walled hollow tube rolls without sliding along the floor. The ratio of its translational kinetic energy to its rotational kinetic energy (about an axis through its center of mass) is:
- A. 1
 - B. 2
 - C. 3
 - D. $1/2$
 - E. $1/3$

ans: A

9. A sphere and a cylinder of equal mass and radius are simultaneously released from rest on the same inclined plane and roll without sliding down the incline. Then:
- A. the sphere reaches the bottom first because it has the greater inertia
 - B. the cylinder reaches the bottom first because it picks up more rotational energy
 - C. the sphere reaches the bottom first because it picks up more rotational energy
 - D. they reach the bottom together
 - E. none of the above are true
- ans: E
10. A hoop, a uniform disk, and a uniform sphere, all with the same mass and outer radius, start with the same speed and roll without sliding up identical inclines. Rank the objects according to how high they go, least to greatest.
- A. hoop, disk, sphere
 - B. disk, hoop, sphere
 - C. sphere, hoop, disk
 - D. sphere, disk, hoop
 - E. hoop, sphere, disk
- ans: A
11. A hoop rolls with constant velocity and without sliding along level ground. Its rotational kinetic energy is:
- A. half its translational kinetic energy
 - B. the same as its translational kinetic energy
 - C. twice its translational kinetic energy
 - D. four times its translational kinetic energy
 - E. one-third its translational kinetic energy
- ans: B
12. Two identical disks, with rotational inertia $I (= \frac{1}{2}MR^2)$, roll without sliding across a horizontal floor with the same speed and then up inclines. Disk A rolls up its incline without sliding. On the other hand, disk B rolls up a frictionless incline. Otherwise the inclines are identical. Disk A reaches a height 12 cm above the floor before rolling down again. Disk B reaches a height above the floor of:
- A. 24 cm
 - B. 18 cm
 - C. 12 cm
 - D. 8 cm
 - E. 6 cm
- ans: D

13. A yo-yo, arranged as shown, rests on a frictionless surface. When a force \vec{F} is applied to the string as shown, the yo-yo:

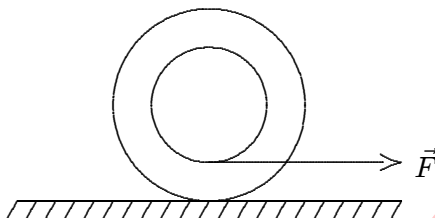

- A. moves to the left and rotates counterclockwise
B. moves to the right and rotates counterclockwise
C. moves to the left and rotates clockwise
D. moves to the right and rotates clockwise
E. moves to the right and does not rotate
ans: B
14. When we apply the energy conservation principle to a cylinder rolling down an incline without sliding, we exclude the work done by friction because:
A. there is no friction present
B. the angular velocity of the center of mass about the point of contact is zero
C. the coefficient of kinetic friction is zero
D. the linear velocity of the point of contact (relative to the inclined surface) is zero
E. the coefficient of static and kinetic friction are equal
ans: D
15. Two uniform cylinders have different masses and different rotational inertias. They simultaneously start from rest at the top of an inclined plane and roll without sliding down the plane. The cylinder that gets to the bottom first is:
A. the one with the larger mass
B. the one with the smaller mass
C. the one with the larger rotational inertia
D. the one with the smaller rotational inertia
E. neither (they arrive together)
ans: E
16. A 5.0-kg ball rolls without sliding from rest down an inclined plane. A 4.0-kg block, mounted on roller bearings totaling 100 g, rolls from rest down the same plane. At the bottom, the block has:
A. greater speed than the ball
B. less speed than the ball
C. the same speed as the ball
D. greater or less speed than the ball, depending on the angle of inclination
E. greater or less speed than the ball, depending on the radius of the ball
ans: A

17. A cylinder of radius $R = 6.0$ cm is on a rough horizontal surface. The coefficient of kinetic friction between the cylinder and the surface is 0.30 and the rotational inertia for rotation about the axis is given by $MR^2/2$, where M is its mass. Initially it is not rotating but its center of mass has a speed of 7.0 m/s. After 2.0 s the speed of its center of mass and its angular velocity about its center of mass, respectively, are:
- A. 1.1 m/s, 0
 - B. 1.1 m/s, 19 rad/s
 - C. 1.1 m/s, 98 rad/s
 - D. 1.1 m/s, 200 rad/s
 - E. 5.9 m/s, 98 rad/s
- ans: D
18. The fundamental dimensions of angular momentum are:
- A. mass·length·time⁻¹
 - B. mass·length⁻²·time⁻²
 - C. mass²·time⁻¹
 - D. mass·length²·time⁻²
 - E. none of these
- ans: E
19. Possible units of angular momentum are:
- A. kg·m/s
 - B. kg·m²/s²
 - C. kg·m/s²
 - D. kg·m²/s
 - E. none of these
- ans: D
20. The unit kg·m²/s can be used for:
- A. angular momentum
 - B. rotational kinetic energy
 - C. rotational inertia
 - D. torque
 - E. power
- ans: A
21. The newton-second is a unit of:
- A. work
 - B. angular momentum
 - C. power
 - D. linear momentum
 - E. none of these
- ans: D

22. A 2.0-kg block travels around a 0.50-m radius circle with an angular velocity of 12 rad/s. The magnitude of its angular momentum about the center of the circle is:
- A. $6.0 \text{ kg} \cdot \text{m}^2/\text{s}$
 - B. $12 \text{ kg} \cdot \text{m}^2/\text{s}$
 - C. $48 \text{ kg}/\text{m}^2 \cdot \text{s}$
 - D. $72 \text{ kg} \cdot \text{m}^2/\text{s}^2$
 - E. $576 \text{ kg}/\text{m}^2 \cdot \text{s}^2$
- ans: A

23. The angular momentum vector of Earth about its rotation axis, due to its daily rotation, is directed:
- A. tangent to the equator toward the east
 - B. tangent to the equator toward the west
 - C. north
 - D. south
 - E. toward the Sun
- ans: C

24. A 6.0-kg particle moves to the right at 4.0 m/s as shown. The magnitude of its angular momentum about the point O is:

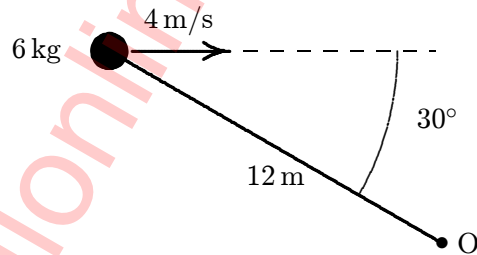

- A. zero
 - B. $288 \text{ kg} \cdot \text{m}^2/\text{s}$
 - C. $144 \text{ kg} \cdot \text{m}^2/\text{s}$
 - D. $24 \text{ kg} \cdot \text{m}^2/\text{s}$
 - E. $249 \text{ kg} \cdot \text{m}^2/\text{s}$
- ans: C

25. Two objects are moving in the x, y plane as shown. The magnitude of their total angular momentum (about the origin O) is:

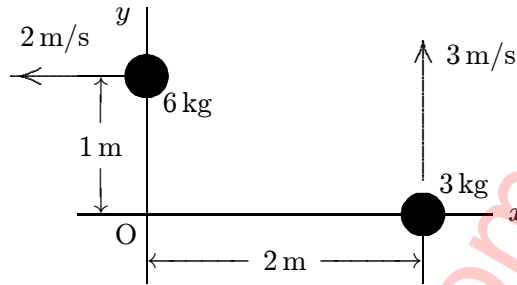

- A. zero
 B. $6 \text{ kg} \cdot \text{m}^2/\text{s}$
 C. $12 \text{ kg} \cdot \text{m}^2/\text{s}$
 D. $30 \text{ kg} \cdot \text{m}^2/\text{s}$
 E. $78 \text{ kg} \cdot \text{m}^2/\text{s}$
 ans: D
26. A 2.0-kg block starts from rest on the positive x axis 3.0 m from the origin and thereafter has an acceleration given by $\vec{a} = (4.0 \text{ m/s}^2)\hat{i} - (3.0 \text{ m/s}^2)\hat{j}$. At the end of 2.0 s its angular momentum about the origin is:
- A. 0
 B. $(-36 \text{ kg} \cdot \text{m}^2/\text{s})\hat{k}$
 C. $(+48 \text{ kg} \cdot \text{m}^2/\text{s})\hat{k}$
 D. $(-96 \text{ kg} \cdot \text{m}^2/\text{s})\hat{k}$
 E. $(+96 \text{ kg} \cdot \text{m}^2/\text{s})\hat{k}$
 ans: B
27. A 15-g paper clip is attached to the rim of a phonograph record with a radius of 30 cm, spinning at 3.5 rad/s. The magnitude of its angular momentum is:
- A. $1.4 \times 10^{-3} \text{ kg} \cdot \text{m}^2/\text{s}$
 B. $4.7 \times 10^{-3} \text{ kg} \cdot \text{m}^2/\text{s}$
 C. $1.6 \times 10^{-2} \text{ kg} \cdot \text{m}^2/\text{s}$
 D. $3.2 \times 10^{-1} \text{ kg} \cdot \text{m}^2/\text{s}$
 E. $1.1 \text{ kg} \cdot \text{m}^2/\text{s}$
 ans: B
28. As a 2.0-kg block travels around a 0.50-m radius circle it has an angular speed of 12 rad/s. The circle is parallel to the xy plane and is centered on the z axis, 0.75 m from the origin. The magnitude of its angular momentum around the origin is:
- A. $6.0 \text{ kg} \cdot \text{m}^2/\text{s}$
 B. $9.0 \text{ kg} \cdot \text{m}^2/\text{s}$
 C. $11 \text{ kg} \cdot \text{m}^2/\text{s}$
 D. $14 \text{ kg} \cdot \text{m}^2/\text{s}$
 E. $20 \text{ kg} \cdot \text{m}^2/\text{s}$
 ans: C

29. As a 2.0-kg block travels around a 0.50-m radius circle it has an angular speed of 12 rad/s. The circle is parallel to the xy plane and is centered on the z axis, a distance of 0.75 m from the origin. The z component of the angular momentum around the origin is:
- $6.0 \text{ kg} \cdot \text{m}^2/\text{s}$
 - $9.0 \text{ kg} \cdot \text{m}^2/\text{s}$
 - $11 \text{ kg} \cdot \text{m}^2/\text{s}$
 - $14 \text{ kg} \cdot \text{m}^2/\text{s}$
 - $20 \text{ kg} \cdot \text{m}^2/\text{s}$
- ans: A
30. As a 2.0-kg block travels around a 0.50-m radius circle it has an angular speed of 12 rad/s. The circle is parallel to the xy plane and is centered on the z axis, 0.75 m from the origin. The component in the xy plane of the angular momentum around the origin has a magnitude of:
- 0
 - $6.0 \text{ kg} \cdot \text{m}^2/\text{s}$
 - $9.0 \text{ kg} \cdot \text{m}^2/\text{s}$
 - $11 \text{ kg} \cdot \text{m}^2/\text{s}$
 - $14 \text{ kg} \cdot \text{m}^2/\text{s}$
- ans: C
31. A uniform disk has radius R and mass M . When it is spinning with angular velocity ω about an axis through its center and perpendicular to its face its angular momentum is $I\omega$. When it is spinning with the same angular velocity about a parallel axis a distance h away its angular momentum is:
- $I\omega$
 - $(I + Mh^2)\omega$
 - $(I - Mh^2)\omega$
 - $(I + MR^2)\omega$
 - $(I - MR^2)\omega$
- ans: B
32. A pulley with radius R and rotational inertia I is free to rotate on a horizontal fixed axis through its center. A string passes over the pulley. A block of mass m_1 is attached to one end and a block of mass m_2 is attached to the other. At one time the block with mass m_1 is moving downward with speed v . If the string does not slip on the pulley, the magnitude of the total angular momentum, about the pulley center, of the blocks and pulley, considered as a system, is given by:
- $(m_1 - m_2)vR + Iv/R$
 - $(m_1 + m_2)vR + Iv/R$
 - $(m_1 - m_2)vR + Iv/R^2$
 - $(m_1 + m_2)vR + Iv/R^2$
 - none of the above
- ans: B

33. A single force acts on a particle situated on the positive x axis. The torque about the origin is in the negative z direction. The force might be:
- A. in the positive y direction
 - B. in the negative y direction
 - C. in the positive x direction
 - D. in the negative x direction
 - E. in the positive z direction
- ans: B

34. A rod rests on frictionless ice. Forces that are equal in magnitude and opposite in direction are then simultaneously applied to its ends as shown. The quantity that vanishes is its:

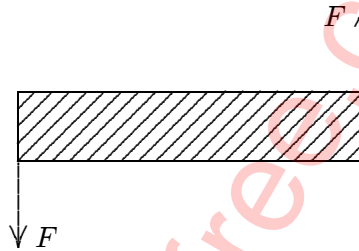

- A. angular momentum
 - B. angular acceleration
 - C. total linear momentum
 - D. kinetic energy
 - E. rotational inertia
- ans: C
35. A 2.0-kg stone is tied to a 0.50-m long string and swung around a circle at a constant angular velocity of 12 rad/s. The net torque on the stone about the center of the circle is:
- A. 0
 - B. $6.0 \text{ N} \cdot \text{m}$
 - C. $12 \text{ N} \cdot \text{m}$
 - D. $72 \text{ N} \cdot \text{m}$
 - E. $140 \text{ N} \cdot \text{m}$
- ans: A
36. A 2.0-kg stone is tied to a 0.50-m long string and swung around a circle at a constant angular velocity of 12 rad/s. The circle is parallel to the xy plane and is centered on the z axis, 0.75 m from the origin. The magnitude of the torque about the origin is:
- A. 0
 - B. $6.0 \text{ N} \cdot \text{m}$
 - C. $14 \text{ N} \cdot \text{m}$
 - D. $72 \text{ N} \cdot \text{m}$
 - E. $108 \text{ N} \cdot \text{m}$
- ans: E

37. A 2.0-kg block starts from rest on the positive x axis 3.0 m from the origin and thereafter has an acceleration given by $\vec{a} = (4.0 \text{ m/s}^2)\hat{i} - (3.0 \text{ m/s}^2)\hat{j}$. The torque, relative to the origin, acting on it at the end of 2.0 s is:
- 0
 - $(-18 \text{ N} \cdot \text{m})\hat{k}$
 - $(+24 \text{ N} \cdot \text{m})\hat{k}$
 - $(-144 \text{ N} \cdot \text{m})\hat{k}$
 - $(+144 \text{ N} \cdot \text{m})\hat{k}$
- ans: B

38. A uniform disk, a thin hoop, and a uniform sphere, all with the same mass and same outer radius, are each free to rotate about a fixed axis through its center. Assume the hoop is connected to the rotation axis by light spokes. With the objects starting from rest, identical forces are simultaneously applied to the rims, as shown. Rank the objects according to their angular momenta after a given time t , least to greatest.

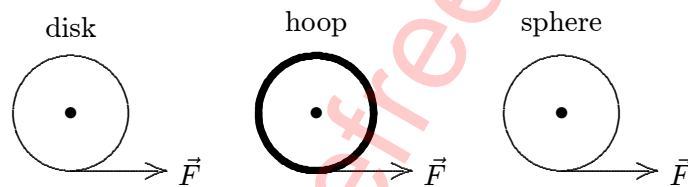

- all tie
 - disk, hoop, sphere
 - hoop, disk, sphere
 - hoop, sphere, disk
 - hoop, disk, sphere
- ans: A
39. A single force acts on a particle P. Rank each of the orientations of the force shown below according to the magnitude of the time rate of change of the particle's angular momentum about the point O, least to greatest.

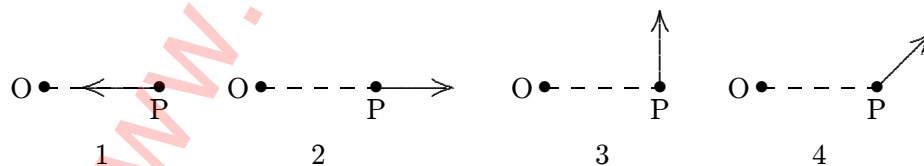

- 1, 2, 3, 4
 - 1 and 2 tie, then 3, 4
 - 1 and 2 tie, then 4, 3
 - 1 and 2 tie, then 3 and 4 tie
 - All are the same
- ans: C

40. A pulley with radius R is free to rotate on a horizontal fixed axis through its center. A string passes over the pulley. Mass m_1 is attached to one end and mass m_2 is attached to the other. The portion of the string attached to m_1 has tension T_1 and the portion attached to m_2 has tension T_2 . The magnitude of the total external torque, about the pulley center, acting on the masses and pulley, considered as a system, is given by:
- $|m_1 - m_2|gR$
 - $(m_1 + m_2)gR$
 - $|m_1 - m_2|gR + (T_1 + T_2)R$
 - $(m_1 + m_2)gR + (T_1 - T_2)R$
 - $|m_1 - m_2|gR + (T_2 - T_1)R$
- ans: A
41. An ice skater with rotational inertia I_0 is spinning with angular speed ω_0 . She pulls her arms in, thereby increasing her angular speed to $4\omega_0$. Her rotational inertia is then:
- I_0
 - $I_0/2$
 - $2I_0$
 - $I_0/4$
 - $4I_0$
- ans: D
42. A man, with his arms at his sides, is spinning on a light frictionless turntable. When he extends his arms:
- his angular velocity increases
 - his angular velocity remains the same
 - his rotational inertia decreases
 - his rotational kinetic energy increases
 - his angular momentum remains the same
- ans: E
43. A man, holding a weight in each hand, stands at the center of a horizontal frictionless rotating turntable. The effect of the weights is to double the rotational inertia of the system. As he is rotating, the man opens his hands and drops the two weights. They fall outside the turntable. Then:
- his angular velocity doubles
 - his angular velocity remains about the same
 - his angular velocity is halved
 - the direction of his angular momentum vector changes
 - his rotational kinetic energy increases
- ans: B

44. A uniform sphere of radius R rotates about a diameter with an angular momentum of magnitude L . Under the action of internal forces the sphere collapses to a uniform sphere of radius $R/2$. The magnitude of its new angular momentum is:
- $L/4$
 - $L/2$
 - L
 - $2L$
 - $4L$

ans: C

45. When a man on a frictionless rotating stool extends his arms horizontally, his rotational kinetic energy:
- must increase
 - must decrease
 - must remain the same
 - may increase or decrease depending on his initial angular velocity
 - may increase or decrease depending on his angular acceleration

ans: B

46. When a woman on a frictionless rotating turntable extends her arms out horizontally, her angular momentum:
- must increase
 - must decrease
 - must remain the same
 - may increase or decrease depending on her initial angular velocity
 - tilts away from the vertical

ans: C

47. Two disks are mounted on low-friction bearings on a common shaft. The first disc has rotational inertia I and is spinning with angular velocity ω . The second disc has rotational inertia $2I$ and is spinning in the same direction as the first disc with angular velocity 2ω as shown. The two disks are slowly forced toward each other along the shaft until they couple and have a final common angular velocity of:

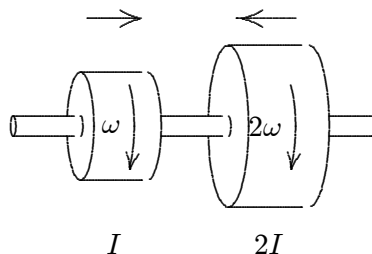

- $5\omega/3$
- $\omega\sqrt{3}$
- $\omega\sqrt{7/3}$
- ω
- 3ω

ans: A

48. A wheel with rotational inertia I , mounted on a vertical shaft with negligible rotational inertia, is rotating with angular speed ω_0 . A nonrotating wheel with rotational inertia $2I$ is suddenly dropped onto the same shaft as shown. The resultant combination of the two wheels and shaft will rotate at:

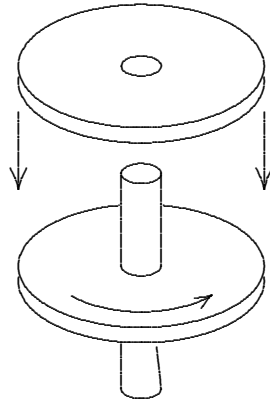

- A. $\omega_0/2$
 B. $2\omega_0$
 C. $\omega_0/3$
 D. $3\omega_0$
 E. $\omega_0/4$

ans: C

49. A phonograph record is dropped onto a freely spinning turntable. Then:
- A. neither angular momentum nor mechanical energy is conserved because of the frictional forces between record and turntable
 B. the frictional force between record and turntable increases the total angular momentum
 C. the frictional force between record and turntable decreases the total angular momentum
 D. the total angular momentum remains constant
 E. the sum of the angular momentum and rotational kinetic energy remains constant

ans: D

50. A playground merry-go-round has a radius R and a rotational inertia I . When the merry-go-round is at rest, a child with mass m runs with speed v along a line tangent to the rim and jumps on. The angular velocity of the merry-go-round is then:

- A. mv/I
 B. v/R
 C. mRv/I
 D. $2mRv/I$
 E. $mRv/(mR^2 + I)$

ans: E

51. A playground merry-go-round has a radius of 3.0 m and a rotational inertia of $600 \text{ kg} \cdot \text{m}^2$. It is initially spinning at 0.80 rad/s when a 20-kg child crawls from the center to the rim. When the child reaches the rim the angular velocity of the merry-go-round is:
- 0.62 rad/s
 - 0.73 rad/s
 - 0.80 rad/s
 - 0.89 rad/s
 - 1.1 rad/s
- ans: A

52. Two pendulum bobs of unequal mass are suspended from the same fixed point by strings of equal length. The lighter bob is drawn aside and then released so that it collides with the other bob on reaching the vertical position. The collision is elastic. What quantities are conserved in the collision?
- Both kinetic energy and angular momentum of the system
 - Only kinetic energy
 - Only angular momentum
 - Angular speed of lighter bob
 - None of the above
- ans: A

53. A particle, held by a string whose other end is attached to a fixed point C, moves in a circle on a horizontal frictionless surface. If the string is cut, the angular momentum of the particle about the point C:
- increases
 - decreases
 - does not change
 - changes direction but not magnitude
 - none of these
- ans: C

54. A block with mass M , on the end of a string, moves in a circle on a horizontal frictionless table as shown. As the string is slowly pulled through a small hole in the table:

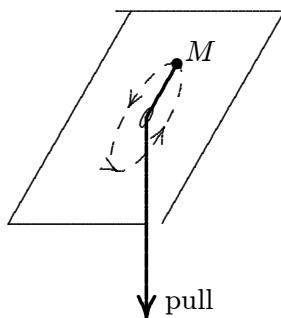

- the angular momentum of the block remains constant
 - the angular momentum of the block decreases
 - the kinetic energy of the block remains constant
 - the kinetic energy of the block decreases
 - none of the above
- ans: A

Chapter 12: EQUILIBRIUM AND ELASTICITY

1. A net torque applied to a rigid object always tends to produce:
 - A. linear acceleration
 - B. rotational equilibrium
 - C. angular acceleration
 - D. rotational inertia
 - E. none of theseans: C
2. The conditions that the net force and the net torque both vanish:
 - A. hold for every rigid body in equilibrium
 - B. hold only for elastic solid bodies in equilibrium
 - C. hold for every solid body
 - D. are always sufficient to calculate the forces on a solid object in equilibrium
 - E. are sufficient to calculate the forces on a solid object in equilibrium only if the object is elasticans: A
3. For an object in equilibrium the net torque acting on it vanishes only if each torque is calculated about:
 - A. the center of mass
 - B. the center of gravity
 - C. the geometrical center
 - D. the point of application of the force
 - E. the same pointans: E
4. For a body to be in equilibrium under the combined action of several forces:
 - A. all the forces must be applied at the same point
 - B. all of the forces form pairs of equal and opposite forces
 - C. the sum of the components of all the forces in any direction must equal zero
 - D. any two of these forces must be balanced by a third force
 - E. the lines of action of all the forces must pass through the center of gravity of the bodyans: C
5. For a body to be in equilibrium under the combined action of several forces:
 - A. all the forces must be applied at the same point
 - B. all of the forces form pairs of equal and opposite forces
 - C. any two of these forces must be balanced by a third force
 - D. the sum of the torques about any point must equal zero
 - E. the lines of action of all the forces must pass through the center of gravity of the bodyans: D

6. To determine if a rigid body is in equilibrium the vector sum of the gravitational forces acting on the particles of the body can be replaced by a single force acting at:
- A. the center of mass
 - B. the geometrical center
 - C. the center of gravity
 - D. a point on the boundary
 - E. none of the above

ans: C

7. The center of gravity coincides with the center of mass:
- A. always
 - B. never
 - C. if the center of mass is at the geometrical center of the body
 - D. if the acceleration due to gravity is uniform over the body
 - E. if the body has a uniform distribution of mass

ans: D

8. The location of which of the following points within an object might depend on the orientation of the object?
- A. Its center of mass
 - B. Its center of gravity
 - C. Its geometrical center
 - D. Its center of momentum
 - E. None of the above

ans: B

9. A cylinder placed so it can roll on a horizontal table top, with its center of gravity above its geometrical center, is:
- A. in stable equilibrium
 - B. in unstable equilibrium
 - C. in neutral equilibrium
 - D. not in equilibrium
 - E. none of the above

ans: B

10. A cylinder placed so it can roll on a horizontal table top, with its center of gravity below its geometrical center, is:
- A. in stable equilibrium
 - B. in unstable equilibrium
 - C. in neutral equilibrium
 - D. not in equilibrium
 - E. none of the above

ans: A

11. A cube balanced with one edge in contact with a table top and with its center of gravity directly above the edge is in _____ equilibrium with respect to rotation about the edge and in _____ equilibrium with respect to rotation about a horizontal axis that is perpendicular to the edge.
- A. stable, stable
 B. stable, unstable
 C. unstable, stable
 D. unstable, unstable
 E. unstable, neutral
- ans: C

12. A meter stick on a horizontal frictionless table top is pivoted at the 80-cm mark. A force \vec{F}_1 is applied perpendicularly to the end of the stick at 0 cm, as shown. A second force \vec{F}_2 (not shown) is applied perpendicularly at the 100-cm end of the stick. The forces are horizontal. If the stick does not move, the force exerted by the pivot on the stick:

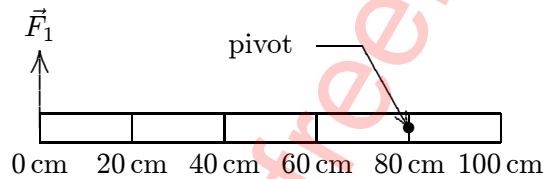

- A. must be zero
 B. must be in the same direction as \vec{F}_1 and have magnitude $|\vec{F}_2| - |\vec{F}_1|$
 C. must be directed opposite to \vec{F}_1 and have magnitude $|\vec{F}_2| - |\vec{F}_1|$
 D. must be in the same direction as \vec{F}_1 and have magnitude $|\vec{F}_2| + |\vec{F}_1|$
 E. must be directed opposite to \vec{F}_1 and have magnitude $|\vec{F}_2| + |\vec{F}_1|$
- ans: E
13. A meter stick on a horizontal frictionless table top is pivoted at the 80-cm mark. A force \vec{F}_1 is applied perpendicularly to the end of the stick at 0 cm, as shown. A second force \vec{F}_2 (not shown) is applied perpendicularly at the 60-cm mark. The forces are horizontal. If the stick does not move, the force exerted by the pivot on the stick:

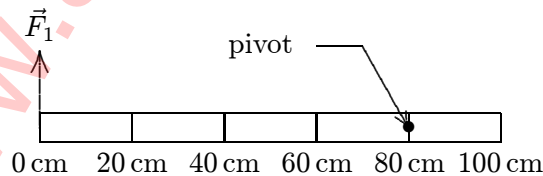

- A. must be zero
 B. must be in the same direction as \vec{F}_1 and have magnitude $|\vec{F}_2| - |\vec{F}_1|$
 C. must be directed opposite to \vec{F}_1 and have magnitude $|\vec{F}_2| - |\vec{F}_1|$
 D. must be in the same direction as \vec{F}_1 and have magnitude $|\vec{F}_2| + |\vec{F}_1|$
 E. must be directed opposite to \vec{F}_1 and have magnitude $|\vec{F}_2| + |\vec{F}_1|$
- ans: B

14. Three identical uniform rods are each acted on by two or more forces, all perpendicular to the rods and all equal in magnitude. Which of the rods could be in static equilibrium if an additional force is applied at the center of mass of the rod?

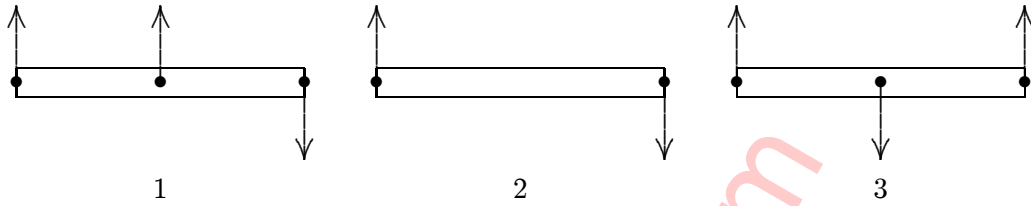

- A. Only 1
 B. Only 2
 C. Only 3
 D. Only 1 and 2
 E. All three

ans: C

15. A 160-N child sits on a light swing and is pulled back and held with a horizontal force of 100 N. The magnitude of the tension force of each of the two supporting ropes is:

- A. 60 N
 B. 94 N
 C. 120 N
 D. 190 N
 E. 260 N

ans: B

16. The diagram shows a stationary 5-kg uniform rod (AC), 1 m long, held against a wall by a rope (AE) and friction between the rod and the wall. To use a single equation to find the force exerted on the rod by the rope at which point should you place the reference point for computing torque?

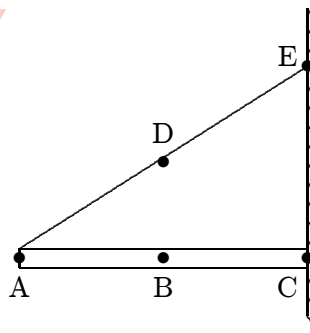

ans: C

17. A picture P of weight W is hung by two strings as shown. The magnitude of the tension force of each string is T . The total upward pull of the strings on the picture is:

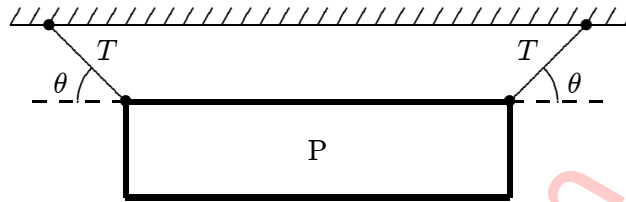

- A. $2W \cos \theta$
 B. $T \sin \theta$
 C. $T \cos \theta$
 D. $2T \sin \theta$
 E. $2T \cos \theta$

ans: D

18. A picture can be hung on a wall with string in three different ways, as shown. The magnitude of the tension force of the string is:

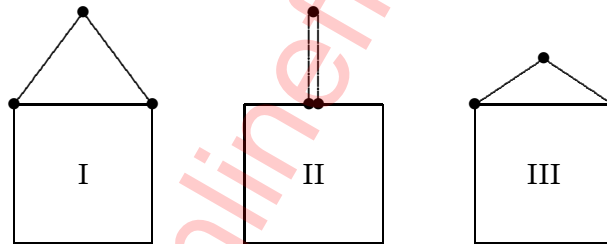

- A. least in I
 B. greatest in I
 C. greatest in II
 D. least in III
 E. greatest in III

ans: E

19. A uniform plank is supported by two equal 120-N forces at X and Y, as shown. The support at X is then moved to Z (half-way to the plank center). The supporting forces at Y and Z are then:

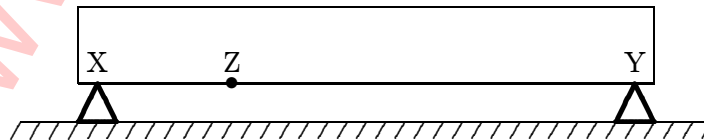

- A. $F_Y = 240 \text{ N}$, $F_Z = 120 \text{ N}$
 B. $F_Y = 200 \text{ N}$, $F_Z = 40 \text{ N}$
 C. $F_Y = 40 \text{ N}$, $F_Z = 200 \text{ N}$
 D. $F_Y = 80 \text{ N}$, $F_Z = 160 \text{ N}$
 E. $F_Y = 160 \text{ N}$, $F_Z = 80 \text{ N}$

ans: D

20. A uniform rod AB is 1.2 m long and weighs 16 N. It is suspended by strings AC and BD as shown. A block P weighing 96 N is attached at E, 0.30 m from A. The magnitude of the tension force of the string BD is:

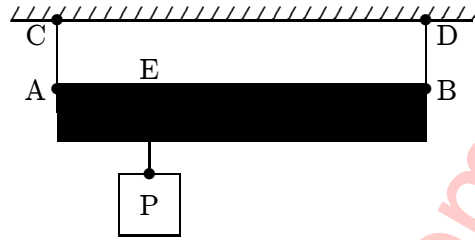

- A. 8.0 N
 B. 24 N
 C. 32 N
 D. 48 N
 E. 80 N

ans: C

21. A 5.0-m weightless strut, hinged to a wall, is used to support an 800-N block as shown. The horizontal and vertical components of the force of the hinge on the strut are:

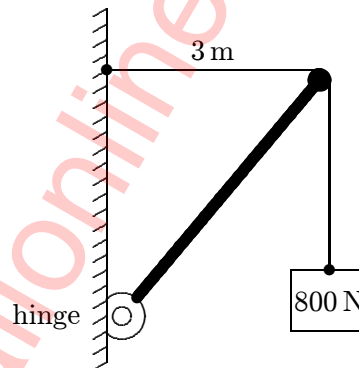

- A. $F_H = 800 \text{ N}$, $F_Y = 800 \text{ N}$
 B. $F_H = 600 \text{ N}$, $F_Y = 800 \text{ N}$
 C. $F_H = 800 \text{ N}$, $F_Y = 600 \text{ N}$
 D. $F_H = 1200 \text{ N}$, $F_Y = 800 \text{ N}$
 E. $F_H = 0$, $F_Y = 800 \text{ N}$

ans: B

22. A uniform plank is 6.0 m long and weighs 80 N. It is balanced on a sawhorse at its center. An additional 160 N weight is now placed on the left end of the plank. To keep the plank balanced, it must be moved what distance to the left?

- A. 6.0 m
 B. 2.0 m
 C. 1.5 m
 D. 1.0 m
 E. 0.50 m

ans: B

23. A uniform 240-g meter stick can be balanced by a 240-g weight placed at the 100-cm mark if the fulcrum is placed at the point marked:
- A. 75 cm
 - B. 60 cm
 - C. 50 cm
 - D. 40 cm
 - E. 80 cm
- ans: A

24. A ladder leans against a wall. If the ladder is not to slip, which one of the following must be true?

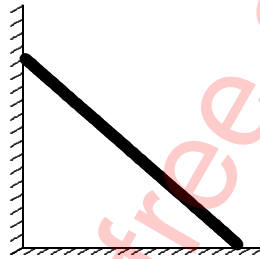

- A. The coefficient of friction between the ladder and the wall must not be zero
 - B. The coefficient of friction between the ladder and the floor must not be zero
 - C. Both A and B
 - D. Either A or B
 - E. Neither A nor B
- ans: B

25. An 80-N uniform plank leans against a frictionless wall as shown. The magnitude of the torque (about point P) applied to the plank by the wall is:

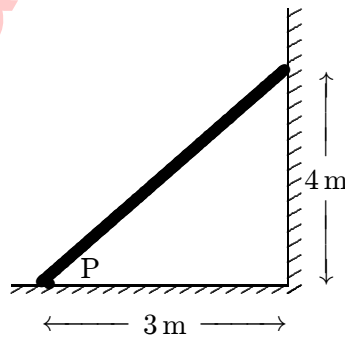

- A. $40 \text{ N} \cdot \text{m}$
 - B. $60 \text{ N} \cdot \text{m}$
 - C. $120 \text{ N} \cdot \text{m}$
 - D. $160 \text{ N} \cdot \text{m}$
 - E. $240 \text{ N} \cdot \text{m}$
- ans: C

26. An 800-N man stands halfway up a 5.0-m long ladder of negligible weight. The base of the ladder is 3.0 m from the wall as shown. Assuming that the wall-ladder contact is frictionless, the wall pushes against the ladder with a force of magnitude:

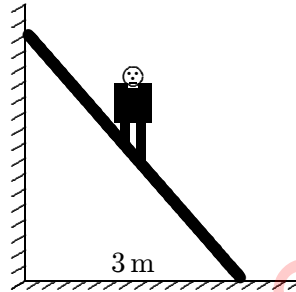

- A. 150 N
- B. 300 N
- C. 400 N
- D. 600 N
- E. 800 N

ans: B

27. A uniform ladder is 10 m long and weighs 400 N. It rests with its upper end against a frictionless vertical wall. Its lower end rests on the ground and is prevented from slipping by a peg driven into the ground. The ladder makes a 30° angle with the horizontal. The magnitude of the force exerted on the peg by the ladder is:

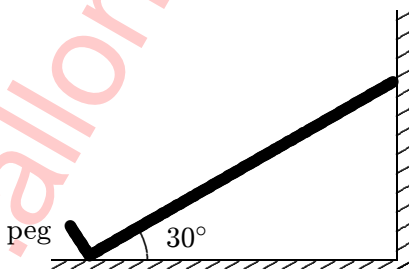

- A. zero
- B. 200 N
- C. 400 N
- D. 470 N
- E. 670 N

ans: D

28. A window washer attempts to lean a ladder against a frictionless wall. He finds that the ladder slips on the ground when it is placed at an angle of less than 75° to the ground but remains in place when the angle is greater than 75° . The coefficient of static friction between the ladder and the ground:
- A. is about 0.13
 - B. is about 0.27
 - C. is about 1.0
 - D. depends on the mass of the ladder
 - E. depends on the length of the ladder

ans: A

29. The 600-N ball shown is suspended on a string AB and rests against a frictionless vertical wall. The string makes an angle of 30° with the wall. The magnitude of the tension force of the string is:

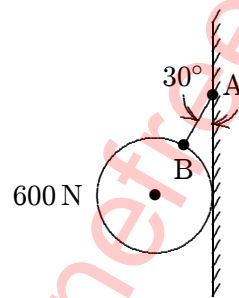

- A. 690 N
- B. 1200 N
- C. 2100 N
- D. 2400 N
- E. none of these

ans: A

30. The 600-N ball shown is suspended on a string AB and rests against a frictionless vertical wall. The string makes an angle of 30° with the wall. The ball presses against the wall with a force of magnitude:

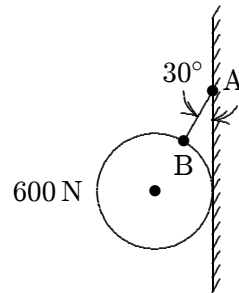

- A. 120 N
- B. 300 N
- C. 350 N
- D. 600 N
- E. 690 N

ans: C

31. The uniform rod shown below is held in place by the rope and wall. Suppose you know the weight of the rod and all dimensions. Then you can solve a single equation for the force of the rope on the rod, provided you write expressions for the torques about the point:

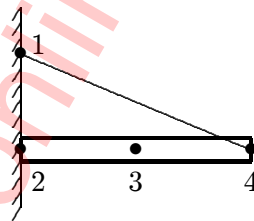

- A. 1
- B. 2
- C. 3
- D. 4
- E. 1, 2, or 3

ans: B

32. A 240-N weight is hung from two ropes as shown. The tension force of the horizontal rope has magnitude:

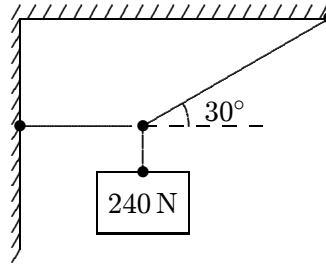

- A. 0
 B. 656 N
 C. 480 N
 D. 416 N
 E. 176 N
 ans: D

33. A 960-N block is suspended as shown. The beam AB is weightless and is hinged to the wall at A. The tension force of the cable BC has magnitude:

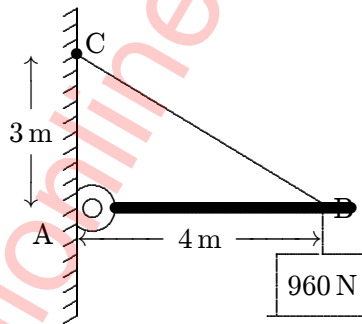

- A. 720 N
 B. 1200 N
 C. 1280 N
 D. 1600 N
 E. none of these
 ans: D

34. A horizontal beam of weight W is supported by a hinge and cable as shown. The force exerted on the beam by the hinge has a vertical component that must be:

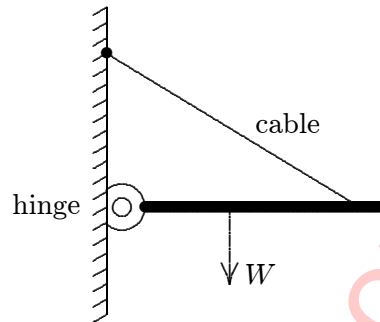

- A. nonzero and up
- B. nonzero and down
- C. nonzero but not enough information given to know whether up or down
- D. zero
- E. equal to W

ans: A

35. A 400-N uniform vertical boom is attached to the ceiling by a hinge, as shown. An 800-N weight W and a horizontal guy wire are attached to the lower end of the boom as indicated. The pulley is massless and frictionless. The tension force T of the horizontal guy wire has magnitude:

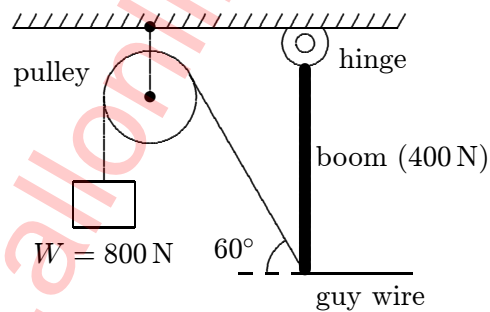

- A. 340 N
- B. 400 N
- C. 690 N
- D. 800 N
- E. 1200 N

ans: B

36. A picture is to be hung from the ceiling by means of two wires. Order the following arrangements of the wires according to the tension force of wire B, from least to greatest.

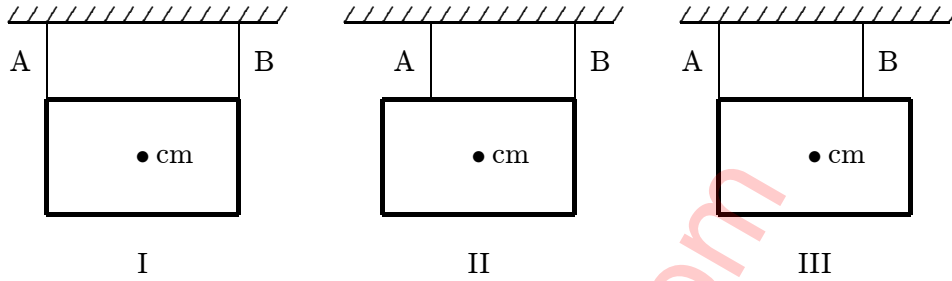

- A. I, II, III
 B. III, II, I
 C. I and II tie, then III
 D. II, I, III
 E. all tie
 ans: D

37. The pull P is just sufficient to keep the 14-N block and the weightless pulleys in equilibrium as shown. The magnitude T of the tension force of the upper cable is:

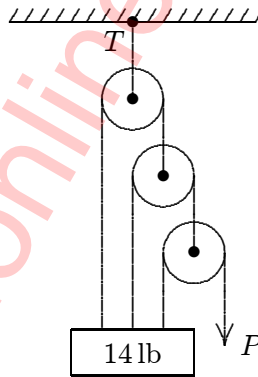

- A. 14 N
 B. 28 N
 C. 16 N
 D. 9.33 N
 E. 18.7 N
 ans: C

38. The ideal mechanical advantage (i.e. the ratio of the weight W to the pull P for equilibrium) of the combination of pulleys shown is:

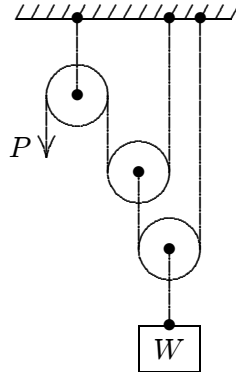

- A. 1
B. 2
C. 3
D. 4
E. 5
ans: D
39. Stress can be measured in:
A. N/m^2
B. $\text{N}\cdot\text{m}^2$
C. N/m
D. $\text{N}\cdot\text{m}$
E. none of these (it is unitless)
ans: A
40. Strain can be measured in:
A. N/m^2
B. $\text{N}\cdot\text{m}^2$
C. N/m
D. $\text{N}\cdot\text{m}$
E. none of these (it is unitless)
ans: E
41. Young's modulus can be correctly given in:
A. $\text{N}\cdot\text{m}$
B. N/m^2
C. $\text{N}\cdot\text{m/s}$
D. N/m
E. joules
ans: B

42. Young's modulus is a proportionality constant that relates the force per unit area applied perpendicularly at the surface of an object to:
- A. the shear
 - B. the fractional change in volume
 - C. the fractional change in length
 - D. the pressure
 - E. the spring constant
- ans: C
43. Young's modulus can be used to calculate the strain for a stress that is:
- A. just below the ultimate strength
 - B. just above the ultimate strength
 - C. well below the yield strength
 - D. well above the yield strength
 - E. none of the above
- ans: C
44. The ultimate strength of a sample is the stress at which the sample:
- A. returns to its original shape when the stress is removed
 - B. remains underwater
 - C. breaks
 - D. bends 180°
 - E. does none of these
- ans: C
45. A certain wire stretches 0.90 cm when outward forces with magnitude F are applied to each end. The same forces are applied to a wire of the same material but with three times the diameter and three times the length. The second wire stretches:
- A. 0.10 cm
 - B. 0.30 cm
 - C. 0.90 cm
 - D. 2.7 cm
 - E. 8.1 cm
- ans: B
46. A force of 5000 N is applied outwardly to each end of a 5.0-m long rod with a radius of 34.0 cm and a Young's modulus of $125 \times 10^8 \text{ N/m}^2$. The elongation of the rod is:
- A. 0.0020 mm
 - B. 0.0040 mm
 - C. 0.14 mm
 - D. 0.55 mm
 - E. 1.42 mm
- ans: D

47. A 4.0-m long steel beam with a cross-sectional area of $1.0 \times 10^{-2} \text{ m}^2$ and a Young's modulus of $2.0 \times 10^{11} \text{ N/m}^2$ is wedged horizontally between two vertical walls. In order to wedge the beam, it is compressed by 0.020 mm. If the coefficient of static friction between the beam and the walls is 0.70 the maximum mass (including its own) it can bear without slipping is:
- A. 0
 - B. 3.6 kg
 - C. 36 kg
 - D. 71 kg
 - E. 710 kg
- ans: E
48. Two supports, made of the same material and initially of equal length, are 2.0 m apart. A stiff board with a length of 4.0 m and a mass of 10 kg is placed on the supports, with one support at the left end and the other at the midpoint. A block is placed on the board a distance of 0.50 m from the left end. As a result the board is horizontal. The mass of the block is:
- A. zero
 - B. 2.3 kg
 - C. 6.6 kg
 - D. 10 kg
 - E. 20 kg
- ans: E
49. The bulk modulus is a proportionality constant that relates the pressure acting on an object to:
- A. the shear
 - B. the fractional change in volume
 - C. the fractional change in length
 - D. Young's modulus
 - E. the spring constant
- ans: B
50. A cube with edges exactly 2 cm long is made of material with a bulk modulus of $3.5 \times 10^9 \text{ N/m}^2$. When it is subjected to a pressure of $3.0 \times 10^5 \text{ Pa}$ its volume is:
- A. 7.31 cm^3
 - B. 7.99931 cm^3
 - C. 8.00069 cm^3
 - D. 8.69 cm^3
 - E. none of these
- ans: B
51. A cube with 2.0-cm sides is made of material with a bulk modulus of $4.7 \times 10^5 \text{ N/m}^2$. When it is subjected to a pressure of $2.0 \times 10^5 \text{ Pa}$ the length of its any of its sides is:
- A. 0.85 cm
 - B. 1.15 cm
 - C. 1.66 cm
 - D. 2.0 cm
 - E. none of these
- ans: C

52. To shear a cube-shaped object, forces of equal magnitude and opposite directions might be applied:
- A. to opposite faces, perpendicular to the faces
 - B. to opposite faces, parallel to the faces
 - C. to adjacent faces, perpendicular to the faces
 - D. to adjacent faces, neither parallel or perpendicular to the faces
 - E. to a single face, in any direction
- ans: B

53. A shearing force of 50 N is applied to an aluminum rod with a length of 10 m, a cross-sectional area of $1.0 \times 10^{-5} \text{ m}^2$, and a shear modulus of $2.5 \times 10^{10} \text{ N/m}^2$. As a result the rod is sheared through a distance of:
- A. zero
 - B. 1.9 mm
 - C. 1.9 cm
 - D. 19 cm
 - E. 1.9 m
- ans: B

Chapter 13: GRAVITATION

- In the formula $F = Gm_1m_2/r^2$, the quantity G :
 - depends on the local value of g
 - is used only when Earth is one of the two masses
 - is greatest at the surface of Earth
 - is a universal constant of nature
 - is related to the Sun in the same way that g is related to Earthans: D
- The magnitude of the acceleration of a planet in orbit around the Sun is proportional to:
 - the mass of the planet
 - the mass of the Sun
 - the distance between the planet and the Sun
 - the reciprocal of the distance between the planet and the Sun
 - the product of the mass of the planet and the mass of the Sunans: B
- Suitable units for the gravitational constant G are:
 - $\text{kg}\cdot\text{m}/\text{s}^2$
 - m/s^2
 - $\text{N}\cdot\text{s}/\text{m}$
 - $\text{kg}\cdot\text{m}/\text{s}$
 - $\text{m}^3/(\text{kg}\cdot\text{s}^2)$ans: E
- The gravitational constant G has the derived units:
 - $\text{N}\cdot\text{m}$
 - $\text{N}\cdot\text{m}/\text{kg}$
 - $\text{N}\cdot\text{kg}/\text{m}$
 - $\text{N}\cdot\text{m}^2/\text{kg}^2$
 - $\text{N}\cdot\text{kg}^2/\text{m}^2$ans: D
- Earth exerts a gravitational force on the Moon, keeping it in its orbit. The reaction to this force, in the sense of Newton's third law, is:
 - the centripetal force on the Moon
 - the nearly circular orbit of the Moon
 - the gravitational force on Earth by the Moon
 - the tides due to the Moon
 - the apple hitting Newton on the head.ans: C

6. A particle might be placed

1. inside a uniform spherical shell of mass M , but not at the center
2. inside a uniform spherical shell of mass M , at the center
3. outside a uniform spherical shell of mass M , a distance r from the center
4. outside a uniform solid sphere of mass M , a distance $2r$ from the center

Rank these situations according to the magnitude of the gravitational force on the particle, least to greatest.

- A. All tie
- B. 1, 2, 3, 4
- C. 1 and 2 tie, then 3 and 4 tie
- D. 1 and 2 tie, then 3, then 4
- E. 1 and 2 tie, then 4, then 3

ans: D

7. Three particles, two with mass m and one with mass M , might be arranged in any of the four configurations known below. Rank the configurations according to the magnitude of the gravitational force on M , least to greatest.

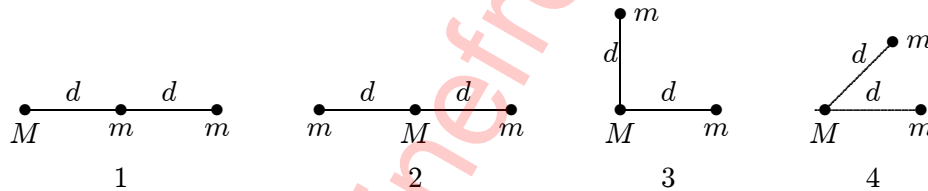

- A. 1, 2, 3, 4
- B. 2, 1, 3, 4
- C. 2, 1, 4, 3
- D. 2, 3, 4, 2
- E. 2, 3, 2, 4

ans: B

8. Four particles, each with mass m are arranged symmetrically about the origin on the x axis. A fifth particle, with mass M , is on the y axis. The direction of the gravitational force on M is:

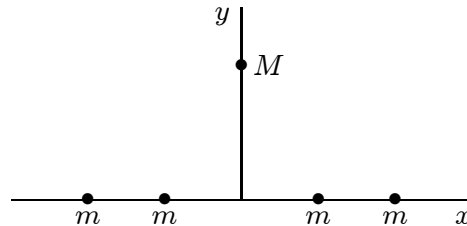

- A. \uparrow
- B. \downarrow
- C. \leftarrow
- D. \rightarrow
- E. none of these directions

ans: B

9. Let F_1 be the magnitude of the gravitational force exerted on the Sun by Earth and F_2 be the magnitude of the force exerted on Earth by the Sun. Then:
- A. F_1 is much greater than F_2
 - B. F_1 is slightly greater than F_2
 - C. F_1 is equal to F_2
 - D. F_1 is slightly less than F_2
 - E. F_1 is much less than F_2

ans: C

10. Let M denote the mass of Earth and let R denote its radius. The ratio g/G at Earth's surface is:
- A. R^2/M
 - B. M/R^2
 - C. MR^2
 - D. M/R
 - E. R/M

ans: B

11. Venus has a mass of about 0.0558 times the mass of Earth and a diameter of about 0.381 times the diameter of Earth. The acceleration of a body falling near the surface of Venus is about:
- A. 0.21 m/s^2
 - B. 1.4 m/s^2
 - C. 2.8 m/s^2
 - D. 3.8 m/s^2
 - E. 25 m/s^2

ans: D

12. The approximate value of g at an altitude above Earth equal to one Earth diameter is:
- A. 9.8 m/s^2
 - B. 4.9 m/s^2
 - C. 2.5 m/s^2
 - D. 1.9 m/s^2
 - E. 1.1 m/s^2

ans: E

13. A rocket ship is coasting toward a planet. Its captain wishes to know the value of g at the surface of the planet. This may be inferred by:
- A. measuring the apparent weight of one of the crew
 - B. measuring the apparent weight of an object of known mass in the ship
 - C. measuring the diameter of the planet
 - D. measuring the density of the planet
 - E. observing the ship's acceleration and correcting for the distance from the center of the planet.

ans: E

14. To measure the mass of a planet with the same radius as Earth, an astronaut drops an object from rest (relative to the planet) from an altitude of one radius above the surface. When the object hits its speed is 4 times what it would be if the same experiment were carried out for Earth. In units of Earth masses, the mass of the planet is:
- A. 2
 - B. 4
 - C. 8
 - D. 16
 - E. 32

ans: D

15. Suppose you have a pendulum clock that keeps correct time on Earth (acceleration due to gravity = 9.8 m/s^2). Without changing the clock, you take it to the Moon (acceleration due to gravity = 1.6 m/s^2). For every hour interval (on Earth) the Moon clock will record:
- A. $(9.8/1.6) \text{ h}$
 - B. 1 h
 - C. $\sqrt{9.8/1.6} \text{ h}$
 - D. $(1.6/9.8) \text{ h}$
 - E. $\sqrt{1.6/9.8} \text{ h}$

ans: E

16. The mass of an object:
- A. is slightly different at different locations on Earth
 - B. is a vector
 - C. is independent of the acceleration due to gravity
 - D. is the same for all objects of the same size and shape
 - E. can be measured directly and accurately on a spring scale

ans: C

17. An astronaut on the Moon simultaneously drops a feather and a hammer. The fact that they land together shows that:
- A. no gravity forces act on a body in a vacuum
 - B. the acceleration due to gravity on the Moon is less than on Earth
 - C. in the absence of air resistance all bodies at a given location fall with the same acceleration
 - D. the feather has a greater weight on the Moon than on Earth
 - E. $G = 0$ on the Moon

ans: C

18. The mass of a hypothetical planet is $1/100$ that of Earth and its radius is $1/4$ that of Earth. If a person weighs 600 N on Earth, what would he weigh on this planet?
- A. 24 N
 - B. 48 N
 - C. 96 N
 - D. 192 N
 - E. 600 N

ans: C

19. An object at the surface of Earth (at a distance R from the center of Earth) weighs 90 N. Its weight at a distance $3R$ from the center of Earth is:
- A. 10 N
 - B. 30 N
 - C. 90 N
 - D. 270 N
 - E. 810 N
- ans: A
20. An object is raised from the surface of Earth to a height of two Earth radii above Earth. Then:
- A. its mass increases and its weight remains constant
 - B. both its mass and weight remain constant
 - C. its mass remains constant and its weight decreases
 - D. both its mass and its weight decrease
 - E. its mass remains constant and its weight increases
- ans: C
21. A spring scale, calibrated in newtons, is used to weigh sugar. If it were possible to weigh sugar at the following locations, where will the buyer get the most sugar to a newton?
- A. At the north pole
 - B. At the equator
 - C. At the center of Earth
 - D. On the Moon
 - E. On Jupiter
- ans: C
22. Of the following where would the weight of an object be the least?
- A. 2000 miles above Earth's surface
 - B. At the north pole
 - C. At the equator
 - D. At the center of Earth
 - E. At the south pole
- ans: D
23. If Earth were to rotate only 100 times per year about its axis:
- A. airplanes flying west to east would make better time
 - B. we would fly off Earth's surface
 - C. our apparent weight would slightly increase
 - D. Earth's atmosphere would float into outer space
 - E. our apparent weight would slightly decrease
- ans: C

24. An astronaut in an orbiting spacecraft feels “weightless” because she:
- A. is beyond the range of gravity
 - B. is pulled outward by centrifugal force
 - C. has no acceleration
 - D. has the same acceleration as the spacecraft
 - E. is outside Earth’s atmosphere
- ans: D
25. Each of the four corners of a square with edge a is occupied by a point mass m . There is a fifth mass, also m , at the center of the square. To remove the mass from the center to a point far away the work that must be done by an external agent is given by:
- A. $4Gm^2/a$
 - B. $-4Gm^2/a$
 - C. $4\sqrt{2}Gm^2/a$
 - D. $-4\sqrt{2}Gm^2/a$
 - E. $4Gm^2/a^2$
- ans: C
26. Two particles, each of mass m , are a distance d apart. To bring a third particle, with mass $2m$, from far away to a resting point midway between the two particles the work done by an external agent is given by:
- A. $4Gm^2/d$
 - B. $-4Gm^2/d$
 - C. $8Gm^2/d^2$
 - D. $-8Gm^2/d^2$
 - E. zero
- ans: D
27. The escape speed at the surface of Earth is approximately 8 km/s. What is the mass, in units of Earth’s mass, of a planet with twice the radius of Earth for which the escape speed is twice that for Earth?
- A. 2
 - B. 4
 - C. 8
 - D. 1/2
 - E. 1/4
- ans: C
28. Neglecting air resistance, a 1.0-kg projectile has an escape velocity of about 11 km/s at the surface of Earth. The corresponding escape velocity for a 2.0 kg projectile is:
- A. 3.5 km/s
 - B. 5.5 km/s
 - C. 7.1 km/s
 - D. 10 km/s
 - E. 11 km/s
- ans: E

29. Neglecting air resistance, the escape speed from a certain planet for an empty space vehicle is 1.12×10^4 m/s. What is the corresponding escape speed for the fully loaded vehicle, which has triple the mass of the empty one?
- A. 3.73×10^3 m/s
 - B. 1.12×10^4 m/s
 - C. 3.36×10^4 m/s
 - D. 9.98×10^4 m/s
 - E. 1.40×10^{12} m/s
- ans: B
30. An object is dropped from an altitude of one Earth radius above Earth's surface. If M is the mass of Earth and R is its radius the speed of the object just before it hits Earth is given by:
- A. $\sqrt{GM/R}$
 - B. $\sqrt{GM/2R}$
 - C. $\sqrt{2GM/R}$
 - D. $\sqrt{GM/R^2}$
 - E. $\sqrt{GM/2R^2}$
- ans: A
31. A projectile is fired straight upward from Earth's surface with a speed that is half the escape speed. If R is the radius of Earth, the highest altitude reached, measured from the surface, is:
- A. $R/4$
 - B. $R/3$
 - C. $R/2$
 - D. R
 - E. $2R$
- ans: B
32. The mass density of a certain planet has spherical symmetry but varies in such a way that the mass inside every spherical surface with center at the center of the planet is proportional to the radius of the surface. If r is the distance from the center of the planet to a point mass inside the planet, the gravitational force on the mass is:
- A. not dependent on r
 - B. proportional to r^2
 - C. proportional to r
 - D. proportional to $1/r$
 - E. proportional to $1/r^2$
- ans: D

33. A spherical shell has inner radius R_1 , outer radius R_2 , and mass M , distributed uniformly throughout the shell. The magnitude of the gravitational force exerted on the shell by a point mass particle of m , located a distance d from the center, inside the inner radius, is:
- 0
 - GMm/R_1^2
 - GMm/d^2
 - $GMm/(R_2^2 - d^2)$
 - $GMm/(R_1 - d)^2$
- ans: A
34. A spherical shell has inner radius R_1 , outer radius R_2 , and mass M , distributed uniformly throughout the shell. The magnitude of the gravitational force exerted on the shell by a point mass m , located a distance d from the center, outside the outer radius, is:
- 0
 - GMm/R_1^2
 - GMm/d^2
 - $GMm/(R_2^2 - d^2)$
 - $GMm/(R_1 - d)^2$
- ans: C
35. A spherical shell has inner radius R_1 , outer radius R_2 , and mass M , distributed uniformly throughout the shell. The magnitude of the gravitational force exerted on the shell by a point particle of mass m located a distance d from the center, outside the inner radius and inside the outer radius, is:
- 0
 - GMm/d^2
 - $GMm/(R_2^3 - d^3)$
 - $GMm(d^3 - R_1^3)/d^2(R_2^3 - R_1^3)$
 - $GMm/(d^3 - R_1^3)$
- ans: D
36. An artificial satellite of Earth releases a bomb. Neglecting air resistance, the bomb will:
- strike Earth under the satellite at the instant of release
 - strike Earth under the satellite at the instant of impact
 - strike Earth ahead of the satellite at the instant of impact
 - strike Earth behind the satellite at the instant of impact
 - never strike Earth
- ans: E
37. An astronaut finishes some work on the outside of his satellite, which is in circular orbit around Earth. He leaves his wrench outside the satellite. The wrench will:
- fall directly down to Earth
 - continue in orbit at reduced speed
 - continue in orbit with the satellite
 - fly off tangentially into space
 - spiral down to Earth
- ans: C

38. The elliptical orbit of a planet around the Sun is shown on the diagram. Which of the following statements is true?

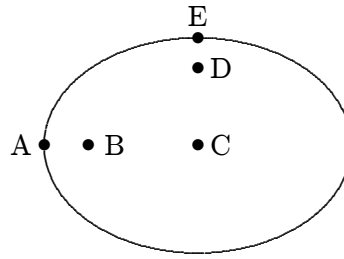

- A. the eccentricity of the orbit is less than zero
 - B. the eccentricity of the orbit is greater than 1
 - C. the sun might be at point C
 - D. the sun might be at point D
 - E. the sun might be at point B
- ans: E
39. Consider the statement: “Earth moves in a stable orbit around the Sun and is therefore in equilibrium”. The statement is:
- A. false, because no moving body can be in equilibrium
 - B. true, because Earth does not fall into or fly away from the Sun
 - C. false, because Earth is rotating on its axis and no rotating body can be in equilibrium
 - D. false, because Earth has a considerable acceleration
 - E. true, because if it were not in equilibrium then buildings and structures would not be stable
- ans: D
40. A planet travels in an elliptical orbit about a star X as shown. The magnitude of the acceleration of the planet is:

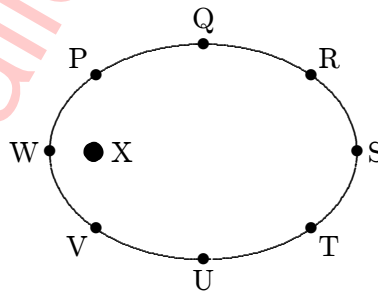

- A. greatest at point Q
 - B. greatest at point S
 - C. greatest at point U
 - D. greatest at point W
 - E. the same at all points
- ans: D

41. In planetary motion the line from the star to the planet sweeps out equal areas in equal times. This is a direct consequence of:
- A. the conservation of energy
 - B. the conservation of momentum
 - C. the conservation of angular momentum
 - D. the conservation of mass
 - E. none of the above

ans: C

42. The speed of a comet in an elliptical orbit about the Sun:
- A. decreases while it is receding from the Sun
 - B. is constant
 - C. is greatest when farthest from the Sun
 - D. varies sinusoidally with time
 - E. equals $L/(mr)$, where L is its angular momentum, m is its mass, and r is its distance from the Sun

ans: A

43. A planet travels in an elliptical orbit about a star as shown. At what pair of points is the speed of the planet the same?

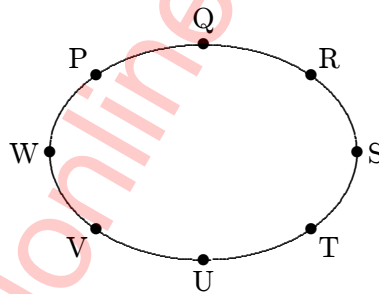

- A. W and S
- B. P and T
- C. P and R
- D. Q and U
- E. V and R

ans: D

44. Planet 1 and planet 2 are both in circular orbits around the same central star. The orbit of planet 2 has a radius that is much larger than the radius of the orbit of planet 1. This means that:
- the period of planet 1 is greater than the period of planet 2 and the speed of planet 1 is greater than the speed of planet 2
 - the period of planet 1 is greater than the period of planet 2 and the speed of planet 1 is less than the speed of planet 2
 - the period of planet 1 is less than the period of planet 2 and the speed of planet 1 is less than the speed of planet 2
 - the period of planet 1 is less than the period of planet 2 and the speed of planet 1 is greater than the speed of planet 2
 - the planets have the same speed and the same period
- ans: D
45. For a planet in orbit around a star the perihelion distance is r_p and its speed at perihelion is v_p . The aphelion distance is r_a and its speed at aphelion is v_a . Which of the following is true?
- $v_a = v_p$
 - $v_a/r_a = v_p/r_p$
 - $v_a r_a = v_p r_p$
 - $v_a/r_a^2 = v_p/r_p^2$
 - $v_a r_a^2 = v_p r_p^2$
- ans: C
46. A planet is in circular orbit around the Sun. Its distance from the Sun is four times the average distance of Earth from the Sun. The period of this planet, in Earth years, is:
- 4
 - 8
 - 16
 - 64
 - 2.52
- ans: B
47. Two planets are orbiting a star in a distant galaxy. The first has a semimajor axis of 150×10^6 km, an eccentricity of 0.20, and a period of 1.0 Earth years. The second has a semimajor axis of 250×10^6 km, an eccentricity of 0.30, and a period of:
- 0.46 Earth years
 - 0.57 Earth years
 - 1.4 Earth years
 - 1.8 Earth years
 - 2.2 Earth years
- ans: E

48. A small satellite is in elliptical orbit around Earth as shown. If L denotes the magnitude of its angular momentum and K denotes kinetic energy:

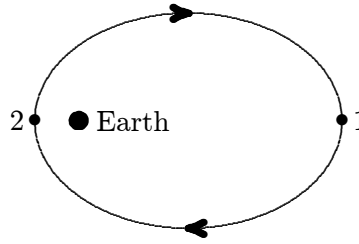

- A. $L_2 > L_1$ and $K_2 > K_1$
 B. $L_2 > L_1$ and $K_2 = K_1$
 C. $L_2 = L_1$ and $K_2 = K_1$
 D. $L_2 < L_1$ and $K_2 = K_1$
 E. $L_2 = L_1$ and $K_2 > K_1$

ans: E

49. Assume that Earth is in circular orbit around the Sun with kinetic energy K and potential energy U , taken to be zero for infinite separation. Then, the relationship between K and U :

- A. is $K = U$
 B. is $K = -U$
 C. is $K = U/2$
 D. is $K = -U/2$
 E. depends on the radius of the orbit

ans: D

50. An artificial Earth satellite is moved from a circular orbit with radius R to a circular orbit with radius $2R$. During this move:

- A. the gravitational force does positive work, the kinetic energy of the satellite increases, and the potential energy of the Earth-satellite system increases
 B. the gravitational force does positive work, the kinetic energy of the satellite increases, and the potential energy of the Earth-satellite system decreases
 C. the gravitational force does positive work, the kinetic energy of the satellite decreases, and the potential energy of the Earth-satellite system increases
 D. the gravitational force does negative work, the kinetic energy of the satellite increases, and the potential energy of the Earth-satellite system decreases
 E. the gravitational force does negative work, the kinetic energy of the satellite decreases, and the potential energy of the Earth-satellite system increases

ans: E

51. An artificial satellite of Earth nears the end of its life due to air resistance. While still in orbit:

- A. it moves faster as the orbit lowers
 B. it moves slower as the orbit lowers
 C. it slowly spirals away from Earth
 D. it moves slower in the same orbit but with a decreasing period
 E. it moves faster in the same orbit but with an increasing period

ans: A

52. A spaceship is returning to Earth with its engine turned off. Consider only the gravitational field of Earth and let M be the mass of Earth, m be the mass of the spaceship, and R be the distance from the center of Earth. In moving from position 1 to position 2 the kinetic energy of the spaceship increases by:
- $GMm \left[\frac{1}{R_2^2} - \frac{1}{R_1^2} \right] GMm/R_2$
 - $GMm \left[\frac{1}{R_1^2} + \frac{1}{R_2^2} \right]$
 - $GMm \frac{R_1 - R_2}{R_1^2}$
 - $GMm \frac{R_1 - R_2}{R_1 R_2}$
 - $GMm \frac{R_1 - R_2}{R_1^2 R_2^2}$
- ans: D
53. Given the perihelion distance, aphelion distance, and speed at perihelion of a planet, which of the following CANNOT be calculated?
- The mass of the star
 - The mass of the planet
 - The speed of the planet at aphelion
 - The period of orbit
 - The semimajor axis of the orbit
- ans: B
54. The orbit of a certain satellite has a semimajor axis of 1.5×10^7 m and an eccentricity of 0.20. Its perigee (minimum distance) and apogee (maximum distance) are respectively:
- 1.2×10^7 m, 1.8×10^7 m
 - 3.0×10^6 m, 1.2×10^7 m
 - 9.6×10^6 m, 1.0×10^7 m
 - 1.0×10^7 m, 1.2×10^7 m
 - 9.6×10^6 m, 1.8×10^7 m
- ans: A
55. A planet in another solar system orbits a star with a mass of 4.0×10^{30} kg. At one point in its orbit it is 250×10^6 km from the star and is moving at 35 km/s. Take the universal gravitational constant to be $6.67 \times 10^{-11} \text{ m}^2/\text{s}^2 \cdot \text{kg}$ and calculate the semimajor axis of the planet's orbit. The result is:
- 79×10^6 km
 - 160×10^6 km
 - 290×10^6 km
 - 320×10^6 km
 - 590×10^6 km
- ans: C

Chapter 14: FLUIDS

- All fluids are:
 - gases
 - liquids
 - gases or liquids
 - non-metallic
 - transparentans: C
- Gases may be distinguished from other forms of matter by their:
 - lack of color
 - small atomic weights
 - inability to form free surfaces
 - ability to flow
 - ability to exert a buoyant forceans: C
- 1 Pa is:
 - 1 N/m
 - 1 m/N
 - 1 kg/m · s
 - 1 kg/m · s²
 - 1 N/m · sans: D
- Mercury is a convenient liquid to use in a barometer because:
 - it is a metal
 - it has a high boiling point
 - it expands little with temperature
 - it has a high density
 - it looks silveryans: D
- To obtain the absolute pressure from the gauge pressure:
 - subtract atmospheric pressure
 - add atmospheric pressure
 - subtract 273
 - add 273
 - convert to N/m²ans: B

6. Barometers and open-tube manometers are two instruments that are used to measure pressure.
- Both measure gauge pressure
 - Both measure absolute pressure
 - Barometers measure gauge pressure and manometers measure absolute pressure
 - Barometers measure absolute pressure and manometers measure gauge pressure
 - Both measure an average of the absolute and gauge pressures

ans: D

7. To measure moderately low pressures oil with a density of $8.5 \times 10^2 \text{ kg/m}^3$ is used in place of mercury in a barometer. A change in the height of the oil column of 1.0 mm indicates a change in pressure of about:

- $1.2 \times 10^{-7} \text{ Pa}$
- $1.2 \times 10^{-5} \text{ Pa}$
- 0.85 Pa
- 1.2 Pa
- 8.3 Pa

ans: E

8. The pressure exerted on the ground by a man is greatest when:

- he stands with both feet flat on the ground
- he stands flat on one foot
- he stands on the toes of one foot
- he lies down on the ground
- all of the above yield the same pressure

ans: C

9. The vessels shown below all contain water to the same height. Rank them according to the pressure exerted by the water on the vessel bottoms, least to greatest.

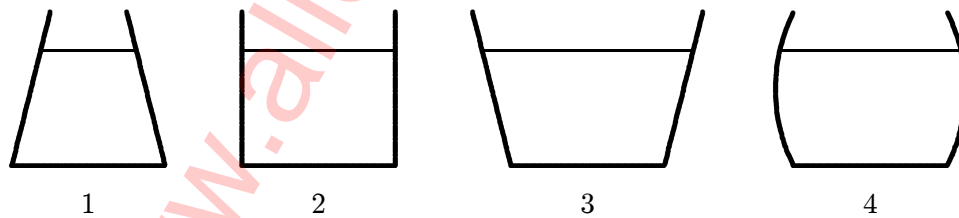

- 1, 2, 3, 4
- 3, 4, 2, 1
- 4, 3, 2, 1
- 2, 3, 4, 1
- All pressures are the same

ans: E

10. In a stationary homogeneous liquid:
- pressure is the same at all points
 - pressure depends on the direction
 - pressure is independent of any atmospheric pressure on the upper surface of the liquid
 - pressure is the same at all points at the same level
 - none of the above
- ans: D
11. Which of the following five statements, concerning the upper surface pressure of a liquid, is FALSE?
- It is independent of the surface area
 - It is the same for all points on that surface
 - It would not increase if the liquid depth were increased
 - It would increase if the liquid density were increased
 - It would increase if the atmospheric pressure increased
- ans: D
12. Several cans of different sizes and shapes are all filled with the same liquid to the same depth. Then:
- the weight of the liquid is the same for all cans
 - the force of the liquid on the bottom of each can is the same
 - the least pressure is at the bottom of the can with the largest bottom area
 - the greatest pressure is at the bottom of the can with the largest bottom area
 - the pressure on the bottom of each can is the same
- ans: E
13. An airtight box, having a lid of area 80 cm^2 , is partially evacuated. Atmospheric pressure is $1.01 \times 10^5 \text{ Pa}$. A force of 600 N is required to pull the lid off the box. The pressure in the box was:
- $2.60 \times 10^4 \text{ Pa}$
 - $6.35 \times 10^4 \text{ Pa}$
 - $7.50 \times 10^4 \text{ Pa}$
 - $1.38 \times 10^5 \text{ Pa}$
 - $1.76 \times 10^5 \text{ Pa}$
- ans: A
14. A closed hemispherical shell of radius R is filled with fluid at uniform pressure p . The net force of the fluid on the curved portion of the shell is given by:
- $2\pi R^2 p$
 - $\pi R^2 p$
 - $4\pi R^2 p$
 - $(4/3)\pi R^2 p$
 - $(4/3)\pi R^3 p$
- ans: B

15. The diagram shows a U-tube with cross-sectional area A and partially filled with oil of density ρ . A solid cylinder, which fits the tube tightly but can slide without friction, is placed in the right arm. The system is in equilibrium. The weight of the cylinder is:

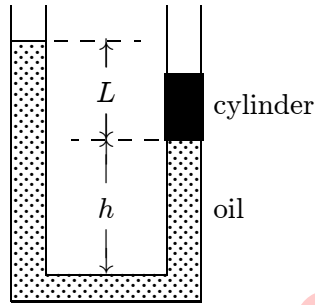

- A. $AL\rho g$
 B. $L^3\rho g$
 C. $A\rho(L+h)g$
 D. $A\rho(L-h)g$
 E. none of these

ans: A

16. The density of water is 1.0 g/cm^3 . The density of the oil in the left column of the U-tube shown below is:

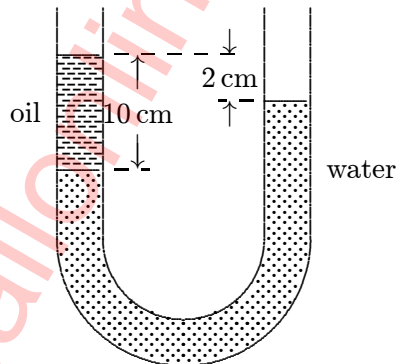

- A. 0.20 g/cm^3
 B. 0.80 g/cm^3
 C. 1.0 g/cm^3
 D. 1.3 g/cm^3
 E. 5.0 g/cm^3

ans: B

17. A uniform U-tube is partially filled with water. Oil, of density 0.75 g/cm^3 , is poured into the right arm until the water level in the left arm rises 3 cm. The length of the oil column is then:
- A. 2.25 cm
 - B. 8 cm
 - C. 6 cm
 - D. 4 cm
 - E. need to know the cross-sectional area of the U-tube

ans: B

18. A long U-tube contains mercury (density = $14 \times 10^3 \text{ kg/m}^3$). When 10 cm of water (density = $1.0 \times 10^3 \text{ kg/m}^3$) is poured into the left arm, the mercury in the right arm rises above its original level by:
- A. 0.36 cm
 - B. 0.72 cm
 - C. 14 cm
 - D. 35 cm
 - E. 70 cm

ans: A

19. A bucket of water is pushed from left to right with increasing speed across a horizontal surface. Consider the pressure at two points at the same level in the water.
- A. It is the same
 - B. It is higher at the point on the left
 - C. It is higher at the point on the right
 - D. At first it is higher at the point on the left but as the bucket speeds up it is lower there
 - E. At first it is higher at the point on the right but as the bucket speeds up it is lower there

ans: B

20. A bucket resting on the floor of an elevator contains an incompressible fluid of density ρ . When the elevator has an upward acceleration of magnitude a the pressure difference between two points in a fluid separated by a vertical distance Δh , is given by:
- A. $\rho a \Delta h$
 - B. $\rho g \Delta h$
 - C. $\rho(g + a) \Delta h$
 - D. $\rho(g - a) \Delta h$
 - E. $\rho g a \Delta h$

ans: C

21. A bucket resting on the floor of an elevator contains an incompressible fluid of density ρ . When the elevator has a downward acceleration of magnitude a the pressure difference between two points in a fluid, separated by a vertical distance Δh , is given by:
- A. $\rho a \Delta h$
 - B. $\rho g \Delta h$
 - C. $\rho(g + a) \Delta h$
 - D. $\rho(g - a) \Delta h$
 - E. $\rho g a \Delta h$

ans: D

22. "An object completely submerged in a fluid displaces its own volume of fluid". This is:
- A. Pascal's paradox
 - B. Archimedes' principle
 - C. Pascal's principle
 - D. true, but none of the above
 - E. false

ans: D

23. A certain object floats in fluids of density

- 1. $0.9\rho_0$
- 2. ρ_0
- 3. $1.1\rho_0$

Which of the following statements is true?

- A. the buoyant force of fluid 1 is greater than the buoyant forces of the other two fluids
- B. the buoyant force of fluid 3 is greater than the buoyant forces of the other two fluids
- C. the three fluids exert the same buoyant force
- D. the object displaces the same volume of all three fluids
- E. none of these are true

ans: C

24. A certain object floats in fluids of density

- 1. $0.9\rho_0$
- 2. ρ_0
- 3. $1.1\rho_0$

Rank these fluids according to the volume displaced by the object, least to greatest.

- A. 1, 2, 3
- B. 3, 2, 1
- C. 2, 3, 1
- D. 3, 1, 2
- E. All are the same

ans: B

25. Two identical blocks of ice float in water as shown. Then:

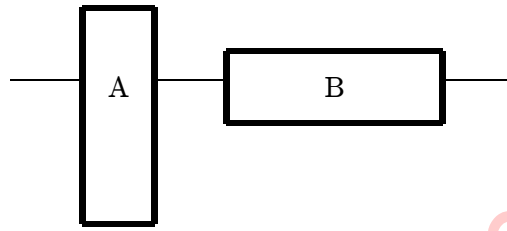

- A. block A displaces a greater volume of water since the pressure acts on a smaller bottom area
B. block B displaces a greater volume of water since the pressure is less on its bottom
C. the two blocks displace equal volumes of water since they have the same weight
D. block A displaces a greater volume of water since its submerged end is lower in the water
E. block B displaces a greater volume of water since its submerged end has a greater area
ans: C
26. A block of ice at 0°C is floating on the surface of ice water in a beaker. The surface of the water just comes to the top of the beaker. When the ice melts the water level will:
A. rise and overflow will occur
B. remain the same
C. fall
D. depend on the initial ratio of water to ice
E. depend on the shape of the block of ice
ans: B
27. A block of ice at 0°C containing a piece of cork is floating on the surface of ice water in a beaker. When the ice has melted the water level:
A. is higher
B. is lower
C. is the same
D. depends on the initial ratio of water to ice
E. depends on the shape of the ice block
ans: C
28. A pirate chest rests at the bottom of an ocean. If the water is still, the net force it exerts on the chest:
A. is upward
B. is downward
C. is zero
D. depends on the mass of the chest
E. depends on the contents of the chest
ans: B

29. A small steel ball floats in a half-full container of mercury. When water is added:
- A. the ball will float on the water
 - B. the ball will rise slightly
 - C. the mercury will float on the water
 - D. the ball will sink to the bottom of the container
 - E. the ball will lower slightly more into the mercury
- ans: B
30. A cork floats on the surface of an incompressible liquid in a container exposed to atmospheric pressure. The container is then sealed and the air above the liquid is evacuated. The cork:
- A. sinks slightly
 - B. rises slightly
 - C. floats at the same height
 - D. bobs up and down about its old position
 - E. behaves erratically
- ans: C
31. An object hangs from a spring balance. The balance indicates 30 N in air and 20 N when the object is submerged in water. What does the balance indicate when the object is submerged in a liquid with a density that is half that of water?
- A. 20 N
 - B. 25 N
 - C. 30 N
 - D. 35 N
 - E. 40 N
- ans: B
32. A fir wood board floats in fresh water with 60% of its volume under water. The density of the wood in g/cm^3 is:
- A. 0.4
 - B. 0.5
 - C. 0.6
 - D. less than 0.4
 - E. more than 0.6
- ans: C
33. A boat floating in fresh water displaces 16,000 N of water. How many newtons of saltwater would it displace if it floats in saltwater of specific gravity 1.17?
- A. 14,500
 - B. 17,600
 - C. 16,000
 - D. 284
 - E. 234
- ans: C

34. A rock, which weighs 1400 N in air, has an apparent weight of 900 N when submerged in fresh water (998 kg/m^3). The volume of the rock is:
- A. 0.14 m^3
 - B. 0.60 m^3
 - C. 0.90 m^3
 - D. $5.1 \times 10^{-2} \text{ m}^3$
 - E. $9.2 \times 10^{-2} \text{ m}^3$
- ans: D
35. A loaded ship passes from a lake (fresh water) to the ocean (saltwater). Saltwater is more dense than fresh water and as a result the ship will:
- A. ride higher in the water
 - B. settle lower in the water
 - C. ride at the same level in the water
 - D. experience an increase in buoyant force
 - E. experience a decrease in buoyant force
- ans: A
36. The dimensions of a wooden raft (density = 150 kg/m^3) are $3.0 \text{ m} \times 3.0 \text{ m} \times 1.0 \text{ m}$. What maximum load can it carry in seawater (density = 1020 kg/m^3)?
- A. 1350 kg
 - B. 7800 kg
 - C. 9200 kg
 - D. 19,500 kg
 - E. 24,300 kg
- ans: B
37. A tin can has a volume of 1000 cm^3 and a mass of 100 g. Approximately what mass of lead shot can it carry without sinking in water?
- A. 900 g
 - B. 100 g
 - C. 1000 g
 - D. 1100 g
 - E. 980 g
- ans: A
38. A block of wood weighs 160 N and has a specific gravity of 0.60. To sink it in fresh water requires an additional downward force of:
- A. 54 N
 - B. 64 N
 - C. 96 N
 - D. 110 N
 - E. 240 N
- ans: D

39. A student standardizes the concentration of a saltwater solution by slowly adding salt until an egg will just float. The procedure is based on the assumption that:
- A. all eggs have the same volume
 - B. all eggs have the same weight
 - C. all eggs have the same density
 - D. all eggs have the same shape
 - E. the salt tends to neutralize the cholesterol in the egg
- ans: C
40. A solid has a volume of 8 cm^3 . When weighed on a spring scale calibrated in grams, the scale indicates 20 g. What does the scale indicate if the object is weighed while immersed in a liquid of density 2 g/cm^3 ?
- A. 4 g
 - B. 10 g
 - C. 12 g
 - D. 16 g
 - E. Zero, since the object will float
- ans: A
41. A 210-g object apparently loses 30 g when suspended in a liquid of density 2.0 g/cm^3 . The density of the object is:
- A. 7.0 g/cm^3
 - B. 3.5 g/cm^3
 - C. 1.4 g/cm^3
 - D. 14 g/cm^3
 - E. none of these
- ans: D
42. A steel ax and an aluminum piston have the same apparent weight in water. When they are weighed in air:
- A. they weigh the same
 - B. the ax is heavier
 - C. the piston is heavier
 - D. both weigh less than they did in water
 - E. depends on their shapes
- ans: C
43. The apparent weight of a steel sphere immersed in various liquids is measured using a spring scale. The greatest reading is obtained for that liquid:
- A. having the smallest density
 - B. having the largest density
 - C. subject to the greatest atmospheric pressure
 - D. having the greatest volume
 - E. in which the sphere was submerged deepest
- ans: A

44. A 0.50-N metal sinker appears (as measured using a spring scale) to have a weight of 0.45 N when submerged in water. The specific gravity of the metal is:
- A. 6
 - B. 8
 - C. 9
 - D. 10
 - E. 12
- ans: D
45. An object floats on the surface of a fluid. For purposes of calculating the torque on it, the buoyant force is taken to act at:
- A. the center of the bottom surface of the object
 - B. the center of gravity of the object
 - C. the center of gravity of the fluid that the object replaced
 - D. the geometric center of the object
 - E. none of the above
- ans: C
46. A blast of wind tips a sailboat in the clockwise direction when viewed from the stern. When the wind ceases the boat rotates back toward the upright position if, when it is tilted, the center of buoyancy:
- A. is above the center of gravity
 - B. is below the center of gravity
 - C. is to the right of the center of gravity
 - D. is to the left of the center of gravity
 - E. coincides with the center of gravity
- ans: C
47. A cork floats in water in a bucket resting on the floor of an elevator. The elevator then accelerates upward. During the acceleration:
- A. the cork is immersed more
 - B. the cork is immersed less
 - C. the cork is immersed the same amount
 - D. at first the cork is immersed less but as the elevator speeds up it is immersed more
 - E. at first the cork is immersed more but as the elevator speeds up it is immersed less
- ans: C
48. Two balls have the same shape and size but one is denser than the other. If frictional forces are negligible when they are dropped in air, which has the greater acceleration?
- A. The heavier ball
 - B. The lighter ball
 - C. They have the same acceleration
 - D. The heavier ball if atmospheric pressure is high, the lighter ball if it is low
 - E. The lighter ball if atmospheric pressure is high, the heavier ball if it is low
- ans: A

49. The principle of fluid pressure that is used in hydraulic brakes or lifts is that:
- A. pressure is the same at all levels in a fluid
 - B. increases of pressure are transmitted equally to all parts of a fluid
 - C. the pressure at a point in a fluid is due to the weight of the fluid above it
 - D. increases of pressure can only be transmitted through fluids
 - E. the pressure at a given depth is proportional to the depth in the fluid
- ans: B
50. Which of the following statements about Pascal's principle is true?
- A. It is valid only for incompressible fluids
 - B. It explains why light objects float
 - C. It explains why the pressure is greater at the bottom of a lake than at the surface
 - D. It is valid only for objects that are less dense than water
 - E. None of the above are true
- ans: E
51. The hydraulic automobile jack illustrates:
- A. Archimedes' principle
 - B. Pascal's principle
 - C. Hooke's law
 - D. Newton's third law
 - E. Newton's second law
- ans: B
52. One piston in a hydraulic lift has an area that is twice the area of the other. When the pressure at the smaller piston is increased by Δp the pressure at the larger piston:
- A. increases by $2\Delta p$
 - B. increases by $\Delta p/2$
 - C. increases by Δp
 - D. increases by $4\Delta p$
 - E. does not change
- ans: C
53. A hydraulic press has one piston of diameter 2.0 cm and the other piston of diameter 8.0 cm. What force must be applied to the smaller piston to obtain a force of 1600 N at the larger piston?
- A. 6.25 N
 - B. 25 N
 - C. 100 N
 - D. 400 N
 - E. 1600 N
- ans: C

54. The two arms of a U-tube are not identical, one having twice the diameter of the other. A cork in the narrow arm requires a force of 16 N to remove it. The tube is filled with water and the wide arm is fitted with a piston. The minimum force that must be applied to the piston to push the cork out is:
- A. 4 N
 - B. 8 N
 - C. 16 N
 - D. 32 N
 - E. 64 N

ans: E

55. A U-tube has dissimilar arms, one having twice the diameter of the other. It contains an incompressible fluid and is fitted with a sliding piston in each arm, with each piston in contact with the fluid. When the piston in the narrow arm is pushed down a distance d , the piston in the wide arm rises a distance:
- A. d
 - B. $2d$
 - C. $d/2$
 - D. $4d$
 - E. $d/4$

ans: E

56. A U-tube has dissimilar arms, one having twice the diameter of the other. It contains an incompressible fluid and is fitted with a sliding piston in each arm, with each piston in contact with the fluid. When an applied force does work W in pushing the piston in the narrow arm down, the fluid does work _____ on the piston in the wide arm.
- A. W
 - B. $2W$
 - C. $W/2$
 - D. $4W$
 - E. $W/4$

ans: A

57. A fluid is undergoing "incompressible" flow. This means that:
- A. the pressure at a given point cannot change with time
 - B. the velocity at a given point cannot change with time
 - C. the velocity must be the same everywhere
 - D. the pressure must be the same everywhere
 - E. the density cannot change with time or location

ans: E

58. A fluid is undergoing steady flow. Therefore:
- A. the velocity of any given molecule of fluid does not change
 - B. the pressure does not vary from point to point
 - C. the velocity at any given point does not vary with time
 - D. the density does not vary from point to point
 - E. the flow is not uphill or downhill

ans: C

59. If p is a pressure and ρ is a density then p/ρ has units of:
- A. m^2
 - B. m^2/s^2
 - C. N/m^2
 - D. kg/m^2
 - E. m^3/kg
- ans: B
60. One end of a cylindrical pipe has a radius of 1.5 cm. Water (density = $1.0 \times 10^3 \text{ kg}/\text{m}^3$) streams steadily out at 7.0 m/s. The rate at which mass is leaving the pipe is:
- A. 2.5 kg/s
 - B. 4.9 kg/s
 - C. 7.0 kg/s
 - D. 48 kg/s
 - E. $7.0 \times 10^3 \text{ kg}/\text{s}$
- ans: B
61. One end of a cylindrical pipe has a radius of 1.5 cm. Water (density = $1.0 \times 10^3 \text{ kg}/\text{m}^3$) streams steadily out at 7.0 m/s. The volume flow rate is:
- A. $4.9 \times 10^{-3} \text{ m}^3/\text{s}$
 - B. $2.5 \text{ m}^3/\text{s}$
 - C. $4.9 \text{ m}^3/\text{s}$
 - D. $7.0 \text{ m}^3/\text{s}$
 - E. $48 \text{ m}^3/\text{s}$
- ans: A
62. The equation of continuity for fluid flow can be derived from the conservation of:
- A. energy
 - B. mass
 - C. angular momentum
 - D. volume
 - E. pressure
- ans: B

63. The diagram shows a pipe of uniform cross section in which water is flowing. The directions of flow and the volume flow rates (in cm^3/s) are shown for various portions of the pipe. The direction of flow and the volume flow rate in the portion marked A are:

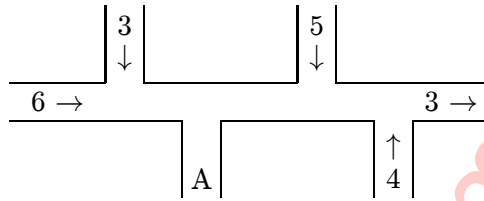

- A. \downarrow and $3 \text{ cm}^3/\text{s}$
 B. \uparrow and $7 \text{ cm}^3/\text{s}$
 C. \downarrow and $9 \text{ cm}^3/\text{s}$
 D. \uparrow and $11 \text{ cm}^3/\text{s}$
 E. \downarrow and $15 \text{ cm}^3/\text{s}$

ans: E

64. An incompressible liquid flows along the pipe as shown. The ratio of the speeds v_2/v_1 is:

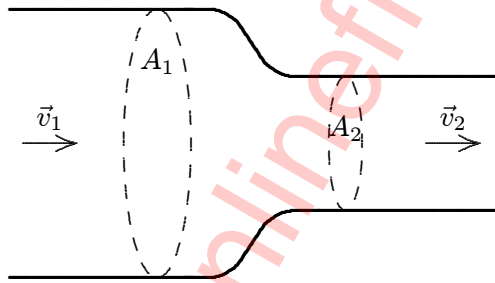

- A. A_1/A_2
 B. A_2/A_1
 C. $\sqrt{A_1/A_2}$
 D. $\sqrt{A_2/A_1}$
 E. v_1/v_2

ans: A

65. Water flows through a cylindrical pipe of varying cross section. The velocity is 3.0 m/s at a point where the pipe diameter is 1.0 cm . At a point where the pipe diameter is 3.0 cm , the velocity is:

- A. 9 m/s
 B. 3 m/s
 C. 1 m/s
 D. 0.33 m/s
 E. 0.11 m/s

ans: D

66. A constriction in a pipe reduces its diameter from 4.0 cm to 2.0 cm. Where the pipe is narrow the water speed is 8.0 m/s. Where it is wide the water speed is:
- A. 2.0 m/s
 - B. 4.0 m/s
 - C. 8.0 m/s
 - D. 16 m/s
 - E. 32 m/s
- ans: C
67. Water flows from a 6.0-cm diameter pipe into an 8.0-cm diameter pipe. The speed in the 6.0-cm pipe is 5.0 m/s. The speed in the 8.0-cm pipe is:
- A. 2.8 m/s
 - B. 3.7 m/s
 - C. 6.6 m/s
 - D. 8.8 m/s
 - E. 9.9 m/s
- ans: A
68. A lawn sprinkler is made of a 1.0-cm diameter garden hose with one end closed and 25 holes, each with a diameter of 0.050 cm, cut near the closed end. If water flows at 2.0 m/s in the hose, the speed of the water leaving a hole is:
- A. 2.0 m/s
 - B. 32 m/s
 - C. 40 m/s
 - D. 600 m/s
 - E. 800 m/s
- ans: B
69. Bernoulli's equation can be derived from the conservation of:
- A. energy
 - B. mass
 - C. angular momentum
 - D. volume
 - E. pressure
- ans: A
70. Which of the following assumptions is NOT made in the derivation of Bernoulli's equation?
- A. Assume streamline flow
 - B. Neglect viscosity
 - C. Neglect friction
 - D. Neglect gravity
 - E. Neglect turbulence
- ans: D

71. The quantity y appearing in Bernoulli's equation MUST be measured:
- A. upward from the center of Earth
 - B. upward from the surface of Earth
 - C. upward from the lowest point in the flow
 - D. downward from the highest point in the flow
 - E. upward from any convenient level
- ans: E
72. Water flows through a constriction in a horizontal pipe. As it enters the constriction, the water's:
- A. speed increases and pressure decreases
 - B. speed increases and pressure remains constant
 - C. speed increases and pressure increases
 - D. speed decreases and pressure increases
 - E. speed decreases and pressure decreases
- ans: A
73. Water is pumped through the hose shown below, from a lower level to an upper level. Compared to the water at point 1, the water at point 2:

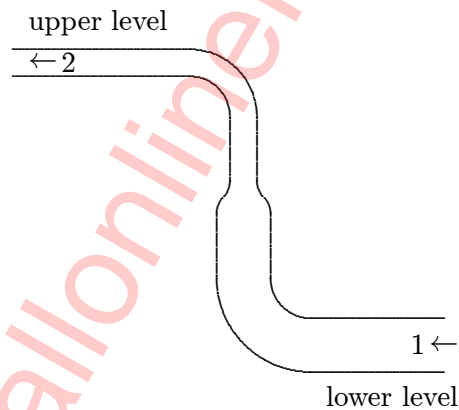

- A. has greater speed and greater pressure
 - B. has greater speed and less pressure
 - C. has less speed and less pressure
 - D. has less speed and greater pressure
 - E. has greater speed and the same pressure
- ans: B

74. A non-viscous incompressible liquid is flowing through a horizontal pipe of constant cross section. Bernoulli's equation and the equation of continuity predict that the drop in pressure along the pipe:
- A. is zero
 - B. depends on the length of the pipe
 - C. depends on the fluid velocity
 - D. depends on the cross-sectional area of the pipe
 - E. depends on the height of the pipe
- ans: A
75. A non-viscous incompressible fluid is pumped steadily into the narrow end of a long tapered pipe and emerges from the wide end. The pressure at the input is greater than at the output. A possible explanation is:
- A. the fluid speed increases from input to output
 - B. the fluid speed is the same at the two ends
 - C. the fluid is flowing uphill
 - D. the fluid is flowing downhill
 - E. the fluid is flowing horizontally
- ans: C
76. Water is pumped into one end of a long pipe at the rate of 40 L/min. It emerges at the other end at 24 L/min. A possible reason for this decrease in flow is:
- A. the water is being pumped uphill
 - B. the water is being pumped downhill
 - C. the diameter of the pipe is not the same at the two ends
 - D. friction in the pipe
 - E. a leak in the pipe
- ans: E
77. Consider a pipe containing a fluid, with the fluid being at rest. To apply Bernoulli's equation to this situation:
- A. set v equal to zero because there is no motion
 - B. set g equal to zero because there is no acceleration
 - C. set v and g both equal to zero
 - D. set p equal to the atmospheric pressure
 - E. cannot be done, Bernoulli's equation applies only to fluids in motion
- ans: A
78. Water (density = $1.0 \times 10^3 \text{ kg/m}^3$) flows through a horizontal tapered pipe. At the wide end its speed is 4.0 m/s. The difference in pressure between the two ends is $4.5 \times 10^3 \text{ Pa}$. The speed of the water at the narrow end is:
- A. 2.6 m/s
 - B. 3.4 m/s
 - C. 4.0 m/s
 - D. 4.5 m/s
 - E. 5.0 m/s
- ans: E

79. Water is streaming downward from a faucet opening with an area of $3.0 \times 10^{-5} \text{ m}^2$. It leaves the faucet with a speed of 5.0 m/s . The cross-sectional area of the stream 0.50 m below the faucet is:
- A. $1.5 \times 10^{-5} \text{ m}^2$
 - B. $2.0 \times 10^{-5} \text{ m}^2$
 - C. $2.5 \times 10^{-5} \text{ m}^2$
 - D. $3.0 \times 10^{-5} \text{ m}^2$
 - E. $3.5 \times 10^{-5} \text{ m}^2$

ans: C

80. A large water tank, open at the top, has a small hole in the bottom. When the water level is 30 m above the bottom of the tank, the speed of the water leaking from the hole:
- A. is 2.5 m/s
 - B. is 24 m/s
 - C. is 44 m/s
 - D. cannot be calculated unless the area of the hole is given
 - E. cannot be calculated unless the areas of the hole and tank are given

ans: B

81. A large tank filled with water has two holes in the bottom, one with twice the radius of the other. In steady flow the speed of water leaving the larger hole is _____ the speed of the water leaving the smaller.
- A. twice
 - B. four times
 - C. half
 - D. one-fourth
 - E. the same as

ans: E

82. A non-viscous incompressible fluid is pumped steadily up a vertical pipe with uniform cross section. The difference in pressure between points at the top and bottom:
- A. is the same as it would be if the fluid were motionless
 - B. is greater at higher flow rates than at lower flow rates
 - C. is less at higher flow rates than at lower flow rates
 - D. does not depend on the density of the fluid
 - E. is zero

ans: A

83. A water line enters a house 2.0 m below ground. A smaller diameter pipe carries water to a faucet 5.0 m above ground, on the second floor. Water flows at 2.0 m/s in the main line and at 7.0 m/s on the second floor. Take the density of water to be $1.0 \times 10^3 \text{ kg/m}^3$. The difference in pressure between the main line and the second floor is:
- A. $7.15 \times 10^4 \text{ Pa}$ with the main line at the higher pressure
 - B. $2.65 \times 10^4 \text{ Pa}$ with the main line at the higher pressure
 - C. $7.15 \times 10^4 \text{ Pa}$ with the main line at the lower pressure
 - D. $2.65 \times 10^4 \text{ Pa}$ with the main line at the lower pressure
 - E. $9.4 \times 10^4 \text{ Pa}$ with the main line at the higher pressure

ans: A

84. A person blows across the top of one arm of a U-tube partially filled with water. The water in that arm:
- A. rises slightly
 - B. drops slightly
 - C. remains at the same height
 - D. rises if the blowing is soft but drops if it is hard
 - E. rises if the blowing is hard but drops if it is soft

ans: A

Chapter 15: OSCILLATIONS

- In simple harmonic motion, the restoring force must be proportional to the:
 - amplitude
 - frequency
 - velocity
 - displacement
 - displacement squaredans: D
- An oscillatory motion must be simple harmonic if:
 - the amplitude is small
 - the potential energy is equal to the kinetic energy
 - the motion is along the arc of a circle
 - the acceleration varies sinusoidally with time
 - the derivative, dU/dx , of the potential energy is negativeans: D
- In simple harmonic motion, the magnitude of the acceleration is:
 - constant
 - proportional to the displacement
 - inversely proportional to the displacement
 - greatest when the velocity is greatest
 - never greater than gans: B
- A particle is in simple harmonic motion with period T . At time $t = 0$ it is at the equilibrium point. Of the following times, at which time is it furthest from the equilibrium point?
 - $0.5T$
 - $0.7T$
 - T
 - $1.4T$
 - $1.5T$ans: B
- A particle moves back and forth along the x axis from $x = -x_m$ to $x = +x_m$, in simple harmonic motion with period T . At time $t = 0$ it is at $x = +x_m$. When $t = 0.75T$:
 - it is at $x = 0$ and is traveling toward $x = +x_m$
 - it is at $x = 0$ and is traveling toward $x = -x_m$
 - it at $x = +x_m$ and is at rest
 - it is between $x = 0$ and $x = +x_m$ and is traveling toward $x = -x_m$
 - it is between $x = 0$ and $x = -x_m$ and is traveling toward $x = -x_m$ans: A

6. A particle oscillating in simple harmonic motion is:
- A. never in equilibrium because it is in motion
 - B. never in equilibrium because there is always a force
 - C. in equilibrium at the ends of its path because its velocity is zero there
 - D. in equilibrium at the center of its path because the acceleration is zero there
 - E. in equilibrium at the ends of its path because the acceleration is zero there
- ans: D
7. An object is undergoing simple harmonic motion. Throughout a complete cycle it:
- A. has constant speed
 - B. has varying amplitude
 - C. has varying period
 - D. has varying acceleration
 - E. has varying mass
- ans: D
8. When a body executes simple harmonic motion, its acceleration at the ends of its path must be:
- A. zero
 - B. less than g
 - C. more than g
 - D. suddenly changing in sign
 - E. none of these
- ans: E
9. A particle is in simple harmonic motion with period T . At time $t = 0$ it is halfway between the equilibrium point and an end point of its motion, traveling toward the end point. The next time it is at the same place is:
- A. $t = T$
 - B. $t = T/2$
 - C. $t = T/4$
 - D. $t = T/8$
 - E. none of the above
- ans: E
10. An object attached to one end of a spring makes 20 complete oscillations in 10 s. Its period is:
- A. 2 Hz
 - B. 10 s
 - C. 0.5 Hz
 - D. 2 s
 - E. 0.50 s
- ans: E

11. An object attached to one end of a spring makes 20 vibrations in 10 s. Its frequency is:
- A. 2 Hz
 - B. 10 s
 - C. 0.05 Hz
 - D. 2 s
 - E. 0.50 s
- ans: A
12. An object attached to one end of a spring makes 20 vibrations in 10 s. Its angular frequency is:
- A. 0.79 rad/s
 - B. 1.57 rad/s
 - C. 2.0 rad/s
 - D. 6.3 rad/s
 - E. 12.6 rad/s
- ans: E
13. Frequency f and angular frequency ω are related by
- A. $f = \pi\omega$
 - B. $f = 2\pi\omega$
 - C. $f = \omega/\pi$
 - D. $f = \omega/2\pi$
 - E. $f = 2\omega/\pi$
- ans: D
14. A block attached to a spring oscillates in simple harmonic motion along the x axis. The limits of its motion are $x = 10$ cm and $x = 50$ cm and it goes from one of these extremes to the other in 0.25 s. Its amplitude and frequency are:
- A. 40 cm, 2 Hz
 - B. 20 cm, 4 Hz
 - C. 40 cm, 2 Hz
 - D. 25 cm, 4 Hz
 - E. 20 cm, 2 Hz
- ans: B
15. A weight suspended from an ideal spring oscillates up and down with a period T . If the amplitude of the oscillation is doubled, the period will be:
- A. T
 - D. $1.5T$
 - B. $2T$
 - C. $T/2$
 - E. $4T$
- ans: A

16. In simple harmonic motion, the magnitude of the acceleration is greatest when:
- A. the displacement is zero
 - B. the displacement is maximum
 - C. the speed is maximum
 - D. the force is zero
 - E. the speed is between zero and its maximum
- ans: B
17. In simple harmonic motion, the displacement is maximum when the:
- A. acceleration is zero
 - B. velocity is maximum
 - C. velocity is zero
 - D. kinetic energy is maximum
 - E. momentum is maximum
- ans: C
18. In simple harmonic motion:
- A. the acceleration is greatest at the maximum displacement
 - B. the velocity is greatest at the maximum displacement
 - C. the period depends on the amplitude
 - D. the acceleration is constant
 - E. the acceleration is greatest at zero displacement
- ans: A
19. The amplitude and phase constant of an oscillator are determined by:
- A. the frequency
 - B. the angular frequency
 - C. the initial displacement alone
 - D. the initial velocity alone
 - E. both the initial displacement and velocity
- ans: E
20. Two identical undamped oscillators have the same amplitude of oscillation only if:
- A. they are started with the same displacement x_0
 - B. they are started with the same velocity v_0
 - C. they are started with the same phase
 - D. they are started so the combination $\omega^2 x_0^2 + v_0^2$ is the same
 - E. they are started so the combination $x_0^2 + \omega^2 v_0^2$ is the same
- ans: D
21. The amplitude of any oscillator can be doubled by:
- A. doubling only the initial displacement
 - B. doubling only the initial speed
 - C. doubling the initial displacement and halving the initial speed
 - D. doubling the initial speed and halving the initial displacement
 - E. doubling both the initial displacement and the initial speed
- ans: E

22. It is impossible for two particles, each executing simple harmonic motion, to remain in phase with each other if they have different:
- A. masses
 - B. periods
 - C. amplitudes
 - D. spring constants
 - E. kinetic energies
- ans: B
23. The acceleration of a body executing simple harmonic motion leads the velocity by what phase?
- A. 0
 - B. $\pi/8$ rad
 - C. $\pi/4$ rad
 - D. $\pi/2$ rad
 - E. π rad
- ans: D
24. The displacement of an object oscillating on a spring is given by $x(t) = x_m \cos(\omega t + \phi)$. If the initial displacement is zero and the initial velocity is in the negative x direction, then the phase constant ϕ is:
- A. 0
 - B. $\pi/2$ rad
 - C. π rad
 - D. $3\pi/2$ rad
 - E. 2π rad
- ans: B
25. The displacement of an object oscillating on a spring is given by $x(t) = x_m \cos(\omega t + \phi)$. If the object is initially displaced in the negative x direction and given a negative initial velocity, then the phase constant ϕ is between:
- A. 0 and $\pi/2$ rad
 - B. $\pi/2$ and π rad
 - C. π and $3\pi/2$ rad
 - D. $3\pi/2$ and 2π rad
 - E. none of the above (ϕ is exactly 0, $\pi/2$, π , or $3\pi/2$ rad)
- ans: B
26. A certain spring elongates 9.0 mm when it is suspended vertically and a block of mass M is hung on it. The natural angular frequency of this block-spring system:
- A. is 0.088 rad/s
 - B. is 33 rad/s
 - C. is 200 rad/s
 - D. is 1140 rad/s
 - E. cannot be computed unless the value of M is given
- ans: B

27. An object of mass m , oscillating on the end of a spring with spring constant k , has amplitude A . Its maximum speed is:

A. $A\sqrt{k/m}$
B. A^2k/m
C. $A\sqrt{m/k}$
D. Am/k
E. A^2m/k

ans: A

28. A 0.20-kg object attached to a spring whose spring constant is 500 N/m executes simple harmonic motion. If its maximum speed is 5.0 m/s, the amplitude of its oscillation is:

A. 0.0020 m
B. 0.10 m
C. 0.20 m
D. 25 m
E. 250 m

ans: B

29. A simple harmonic oscillator consists of a particle of mass m and an ideal spring with spring constant k . Particle oscillates as shown in (i) with period T . If the spring is cut in half and used with the same particle, as shown in (ii), the period will be:

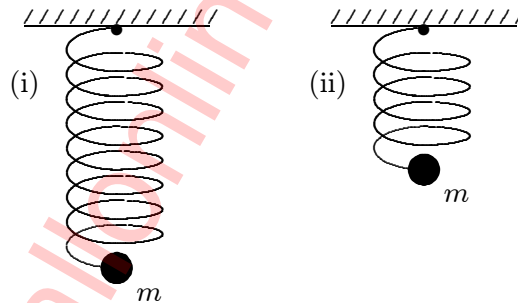

A. $2T$
B. $\sqrt{2}T$
C. $T/\sqrt{2}$
D. T
E. $T/2$

ans: C

30. A particle moves in simple harmonic motion according to $x = 2 \cos(50t)$, where x is in meters and t is in seconds. Its maximum velocity in m/s is:

A. $100 \sin(50t)$
B. $100 \cos(50t)$
C. 100
D. 200
E. none of these

ans: C

31. A 3-kg block, attached to a spring, executes simple harmonic motion according to $x = 2 \cos(50t)$ where x is in meters and t is in seconds. The spring constant of the spring is:
- A. 1 N/m
 - B. 100 N/m
 - C. 150 N/m
 - D. 7500 N/m
 - E. none of these
- ans: D
32. Let U be the potential energy (with the zero at zero displacement) and K be the kinetic energy of a simple harmonic oscillator. U_{avg} and K_{avg} are the average values over a cycle. Then:
- A. $K_{\text{avg}} > U_{\text{avg}}$
 - B. $K_{\text{avg}} < U_{\text{avg}}$
 - C. $K_{\text{avg}} = U_{\text{avg}}$
 - D. $K = 0$ when $U = 0$
 - E. $K + U = 0$
- ans: C
33. A particle is in simple harmonic motion along the x axis. The amplitude of the motion is x_m . At one point in its motion its kinetic energy is $K = 5 \text{ J}$ and its potential energy (measured with $U = 0$ at $x = 0$) is $U = 3 \text{ J}$. When it is at $x = x_m$, the kinetic and potential energies are:
- A. $K = 5 \text{ J}$ and $U = 3 \text{ J}$
 - B. $K = 5 \text{ J}$ and $U = -3 \text{ J}$
 - C. $K = 8 \text{ J}$ and $U = 0$
 - D. $K = 0$ and $U = 8 \text{ J}$
 - E. $K = 0$ and $U = -8 \text{ J}$
- ans: D
34. A particle is in simple harmonic motion along the x axis. The amplitude of the motion is x_m . When it is at $x = x_1$, its kinetic energy is $K = 5 \text{ J}$ and its potential energy (measured with $U = 0$ at $x = 0$) is $U = 3 \text{ J}$. When it is at $x = -\frac{1}{2}x_1$, the kinetic and potential energies are:
- A. $K = 5 \text{ J}$ and $U = 3 \text{ J}$
 - B. $K = 5 \text{ J}$ and $U = -3 \text{ J}$
 - C. $K = 8 \text{ J}$ and $U = 0$
 - D. $K = 0$ and $U = 8 \text{ J}$
 - E. $K = 0$ and $U = -8 \text{ J}$
- ans: A
35. A 0.25-kg block oscillates on the end of the spring with a spring constant of 200 N/m. If the system has an energy of 6.0 J, then the amplitude of the oscillation is:
- A. 0.06 m
 - B. 0.17 m
 - C. 0.24 m
 - D. 4.9 m
 - E. 6.9 m
- ans: C

36. A 0.25-kg block oscillates on the end of the spring with a spring constant of 200 N/m. If the system has an energy of 6.0 J, then the maximum speed of the block is:
- A. 0.06 m/s
 - B. 0.17 m/s
 - C. 0.24 m/s
 - D. 4.9 m/s
 - E. 6.9 m/s
- ans: E
37. A 0.25-kg block oscillates on the end of the spring with a spring constant of 200 N/m. If the oscillation is started by elongating the spring 0.15 m and giving the block a speed of 3.0 m/s, then the maximum speed of the block is:
- A. 0.13 m/s
 - B. 0.18 m/s
 - C. 3.7 m/s
 - D. 5.2 m/s
 - E. 13 m/s
- ans: D
38. A 0.25-kg block oscillates on the end of the spring with a spring constant of 200 N/m. If the oscillation is started by elongating the spring 0.15 m and giving the block a speed of 3.0 m/s, then the amplitude of the oscillation is:
- A. 0.13 m
 - B. 0.18 m
 - C. 3.7 m
 - D. 5.2 m
 - E. 13 m
- ans: B
39. An object on the end of a spring is set into oscillation by giving it an initial velocity while it is at its equilibrium position. In the first trial the initial velocity is v_0 and in the second it is $4v_0$. In the second trial:
- A. the amplitude is half as great and the maximum acceleration is twice as great
 - B. the amplitude is twice as great and the maximum acceleration is half as great
 - C. both the amplitude and the maximum acceleration are twice as great
 - D. both the amplitude and the maximum acceleration are four times as great
 - E. the amplitude is four times as great and the maximum acceleration is twice as great
- ans: C
40. A block attached to a spring undergoes simple harmonic motion on a horizontal frictionless surface. Its total energy is 50 J. When the displacement is half the amplitude, the kinetic energy is:
- A. zero
 - B. 12.5 J
 - C. 25 J
 - D. 37.5 J
 - E. 50 J
- ans: D

41. A mass-spring system is oscillating with amplitude A . The kinetic energy will equal the potential energy only when the displacement is:
- A. zero
 - B. $\pm A/4$
 - C. $\pm A/\sqrt{2}$
 - D. $\pm A/2$
 - E. anywhere between $-A$ and $+A$
- ans: C
42. If the length of a simple pendulum is doubled, its period will:
- A. halve
 - B. be greater by a factor of $\sqrt{2}$
 - C. be less by a factor of $\sqrt{2}$
 - D. double
 - E. remain the same
- ans: B
43. The period of a simple pendulum is 1 s on Earth. When brought to a planet where g is one-tenth that on Earth, its period becomes:
- A. 1 s
 - B. $1/\sqrt{10}$ s
 - C. $1/10$ s
 - D. $\sqrt{10}$ s
 - E. 10 s
- ans: D
44. The amplitude of oscillation of a simple pendulum is increased from 1° to 4° . Its maximum acceleration changes by a factor of:
- A. $1/4$
 - B. $1/2$
 - C. 2
 - D. 4
 - E. 16
- ans: D
45. A simple pendulum of length L and mass M has frequency f . To increase its frequency to $2f$:
- A. increase its length to $4L$
 - B. increase its length to $2L$
 - C. decrease its length to $L/2$
 - D. decrease its length to $L/4$
 - E. decrease its mass to $< M/4$
- ans: D

46. A simple pendulum consists of a small ball tied to a string and set in oscillation. As the pendulum swings the tension force of the string is:
- A. constant
 - B. a sinusoidal function of time
 - C. the square of a sinusoidal function of time
 - D. the reciprocal of a sinusoidal function of time
 - E. none of the above
- ans: E
47. A simple pendulum has length L and period T . As it passes through its equilibrium position, the string is suddenly clamped at its midpoint. The period then becomes:
- A. $2T$
 - B. T
 - C. $T/2$
 - D. $T/4$
 - E. none of these
- ans: E
48. A simple pendulum is suspended from the ceiling of an elevator. The elevator is accelerating upwards with acceleration a . The period of this pendulum, in terms of its length L , g , and a is:
- A. $2\pi\sqrt{L/g}$
 - B. $2\pi\sqrt{L/(g+a)}$
 - C. $2\pi\sqrt{L/(g-a)}$
 - D. $2\pi\sqrt{L/a}$
 - E. $(1/2\pi)\sqrt{g/L}$
- ans: B
49. Three physical pendulums, with masses m_1 , $m_2 = 2m_1$, and $m_3 = 3m_1$, have the same shape and size and are suspended at the same point. Rank them according to their periods, from shortest to longest.
- A. 1, 2, 3
 - B. 3, 2, 1
 - C. 2, 3, 1
 - D. 2, 1, 3
 - E. All the same
- ans: E

50. Five hoops are each pivoted at a point on the rim and allowed to swing as physical pendulums. The masses and radii are
- hoop 1: $M = 150$ g and $R = 50$ cm
 - hoop 2: $M = 200$ g and $R = 40$ cm
 - hoop 3: $M = 250$ g and $R = 30$ cm
 - hoop 4: $M = 300$ g and $R = 20$ cm
 - hoop 5: $M = 350$ g and $R = 10$ cm
- Order the hoops according to the periods of their motions, smallest to largest.
- A. 1, 2, 3, 4, 5
 - B. 5, 4, 3, 2, 1
 - C. 1, 2, 3, 5, 4
 - D. 1, 2, 5, 4, 3
 - E. 5, 4, 1, 2, 3
- ans: B
51. A meter stick is pivoted at a point a distance a from its center and swings as a physical pendulum. Of the following values for a , which results in the shortest period of oscillation?
- A. $a = 0.1$ m
 - B. $a = 0.2$ m
 - C. $a = 0.3$ m
 - D. $a = 0.4$ m
 - E. $a = 0.5$ m
- ans: C
52. The rotational inertia of a uniform thin rod about its end is $ML^2/3$, where M is the mass and L is the length. Such a rod is hung vertically from one end and set into small amplitude oscillation. If $L = 1.0$ m this rod will have the same period as a simple pendulum of length:
- A. 33 cm
 - B. 50 cm
 - C. 67 cm
 - D. 100 cm
 - E. 150 cm
- ans: C
53. Two uniform spheres are pivoted on horizontal axes that are tangent to their surfaces. The one with the longer period of oscillation is the one with:
- A. the larger mass
 - B. the smaller mass
 - C. the larger rotational inertia
 - D. the smaller rotational inertia
 - E. the larger radius
- ans: E

54. The x and y coordinates of a point each execute simple harmonic motion. The result might be a circular orbit if:
- A. the amplitudes are the same but the frequencies are different
 - B. the amplitudes and frequencies are both the same
 - C. the amplitudes and frequencies are both different
 - D. the phase constants are the same but the amplitudes are different
 - E. the amplitudes and the phase constants are both different
- ans: B
55. The x and y coordinates of a point each execute simple harmonic motion. The frequencies are the same but the amplitudes are different. The resulting orbit might be:
- A. an ellipse
 - B. a circle
 - C. a parabola
 - D. a hyperbola
 - E. a square
- ans: A
56. For an oscillator subjected to a damping force proportional to its velocity:
- A. the displacement is a sinusoidal function of time.
 - B. the velocity is a sinusoidal function of time.
 - C. the frequency is a decreasing function of time.
 - D. the mechanical energy is constant.
 - E. none of the above is true.
- ans: E
57. Five particles undergo damped harmonic motion. Values for the spring constant k , the damping constant b , and the mass m are given below. Which leads to the smallest rate of loss of mechanical energy?
- A. $k = 100 \text{ N/m}$, $m = 50 \text{ g}$, $b = 8 \text{ g/s}$
 - B. $k = 150 \text{ N/m}$, $m = 50 \text{ g}$, $b = 5 \text{ g/s}$
 - C. $k = 150 \text{ N/m}$, $m = 10 \text{ g}$, $b = 8 \text{ g/s}$
 - D. $k = 200 \text{ N/m}$, $m = 8 \text{ g}$, $b = 6 \text{ g/s}$
 - E. $k = 100 \text{ N/m}$, $m = 2 \text{ g}$, $b = 4 \text{ g/s}$
- ans: B
58. A sinusoidal force with a given amplitude is applied to an oscillator. To maintain the largest amplitude oscillation the frequency of the applied force should be:
- A. half the natural frequency of the oscillator
 - B. the same as the natural frequency of the oscillator
 - C. twice the natural frequency of the oscillator
 - D. unrelated to the natural frequency of the oscillator
 - E. determined from the maximum speed desired
- ans: B

59. A sinusoidal force with a given amplitude is applied to an oscillator. At resonance the amplitude of the oscillation is limited by:
- the damping force
 - the initial amplitude
 - the initial velocity
 - the force of gravity
 - none of the above

ans: A

60. An oscillator is subjected to a damping force that is proportional to its velocity. A sinusoidal force is applied to it. After a long time:
- its amplitude is an increasing function of time
 - its amplitude is a decreasing function of time
 - its amplitude is constant
 - its amplitude is a decreasing function of time only if the damping constant is large
 - its amplitude increases over some portions of a cycle and decreases over other portions

ans: C

61. A block on a spring is subjected to a damping force that is proportional to its velocity and to an applied sinusoidal force. The energy dissipated by damping is supplied by:
- the potential energy of the spring
 - the kinetic energy of the mass
 - gravity
 - friction
 - the applied force

ans: E

62. The table below gives the values of the spring constant k , damping constant b , and mass m for a particle in damped harmonic motion. Which of these takes the longest time for its mechanical energy to decrease to one-fourth of its initial value?

	k	b	m
A	k_0	b_0	m_0
B	$3k_0$	$2b_0$	m_0
C	$k_0/2$	$6b_0$	$2m_0$
D	$4k_0$	b_0	$2m_0$
E	k_0	b_0	$10m_0$

ans: E

Chapter 16: WAVES — I

1. For a transverse wave on a string the string displacement is described by $y(x, t) = f(x - at)$, where f is a given function and a is a positive constant. Which of the following does NOT necessarily follow from this statement?
 - A. The shape of the string at time $t = 0$ is given by $f(x)$.
 - B. The shape of the waveform does not change as it moves along the string.
 - C. The waveform moves in the positive x direction.
 - D. The speed of the waveform is a .
 - E. The speed of the waveform is x/t .

ans: E

2. A sinusoidal wave is traveling toward the right as shown. Which letter correctly labels the amplitude of the wave?

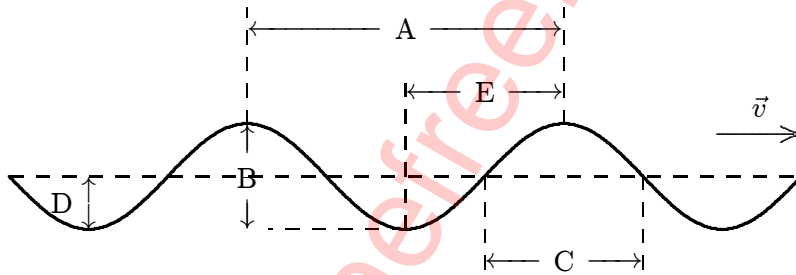

ans: D

3. A sinusoidal wave is traveling toward the right as shown. Which letter correctly labels the wavelength of the wave?

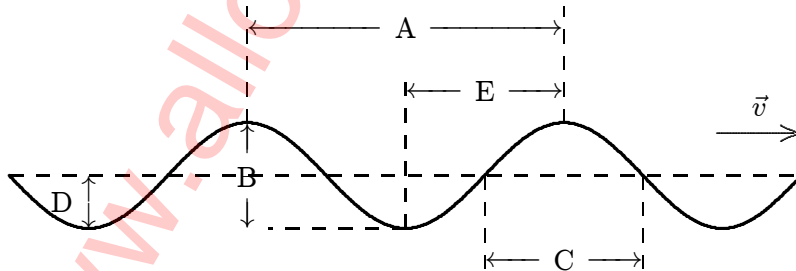

ans: A

4. In the diagram below, the interval PQ represents:

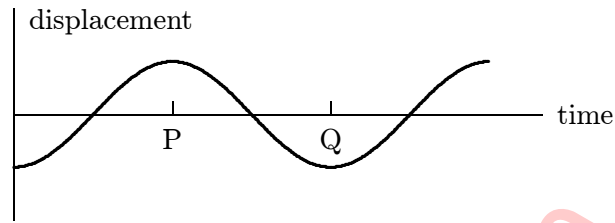

- A. wavelength/2
- B. wavelength
- C. $2 \times$ amplitude
- D. period/2
- E. period

ans: D

5. Let f be the frequency, v the speed, and T the period of a sinusoidal traveling wave. The correct relationship is:

- A. $f = 1/T$
- B. $f = v + T$
- C. $f = vT$
- D. $f = v/T$
- E. $f = T/v$

ans: A

6. Let f be the frequency, v the speed, and T the period of a sinusoidal traveling wave. The angular frequency is given by:

- A. $1/T$
- B. $2\pi/T$
- C. vT
- D. f/T
- E. T/f

ans: B

7. The displacement of a string is given by

$$y(x, t) = y_m \sin(kx + \omega t).$$

The wavelength of the wave is:

- A. $2\pi k/\omega$
- B. k/ω
- C. ωk
- D. $2\pi/k$
- E. $k/2\pi$

ans: D

8. Three traveling sinusoidal waves are on identical strings, with the same tension. The mathematical forms of the waves are $y_1(x, t) = y_m \sin(3x - 6t)$, $y_2(x, t) = y_m \sin(4x - 8t)$, and $y_3(x, t) = y_m \sin(6x - 12t)$, where x is in meters and t is in seconds. Match each mathematical form to the appropriate graph below.

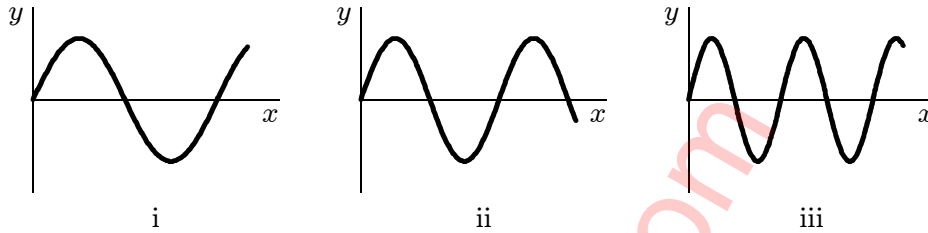

- A. y_1 : i, y_2 : ii, y_3 : iii
 B. y_1 : iii, y_2 : ii, y_3 : i
 C. y_1 : i, y_2 : iii, y_3 : ii
 D. y_1 : ii, y_2 : i, y_3 : iii
 E. y_1 : iii, y_2 : i, y_3 : ii

ans: A

9. The displacement of a string is given by

$$y(x, t) = y_m \sin(kx + \omega t).$$

The speed of the wave is:

- A. $2\pi k/\omega$
 B. ω/k
 C. ωk
 D. $2\pi/k$
 E. $k/2\pi$

ans: B

10. A wave is described by $y(x, t) = 0.1 \sin(3x + 10t)$, where x is in meters, y is in centimeters, and t is in seconds. The angular wave number is:

- A. 0.10 rad/m
 B. 3π rad/m
 C. 10 rad/m
 D. 10π rad/m
 E. 3.0 rad/cm

ans: E

11. A wave is described by $y(x, t) = 0.1 \sin(3x - 10t)$, where x is in meters, y is in centimeters, and t is in seconds. The angular frequency is:

- A. 0.10 rad/s
 B. 3.0π rad/s
 C. 10π rad/s
 D. 20π rad/s
 E. 10 rad/s

ans: E

12. Water waves in the sea are observed to have a wavelength of 300 m and a frequency of 0.07 Hz. The speed of these waves is:
- A. 0.00021 m/s
 - B. 2.1 m/s
 - C. 21 m/s
 - D. 210 m/s
 - E. none of these
- ans: C

13. Sinusoidal water waves are generated in a large ripple tank. The waves travel at 20 cm/s and their adjacent crests are 5.0 cm apart. The time required for each new whole cycle to be generated is:
- A. 100 s
 - B. 4.0 s
 - C. 2.0 s
 - D. 0.5 s
 - E. 0.25 s
- ans: E

14. A traveling sinusoidal wave is shown below. At which point is the motion 180° out of phase with the motion at point P?

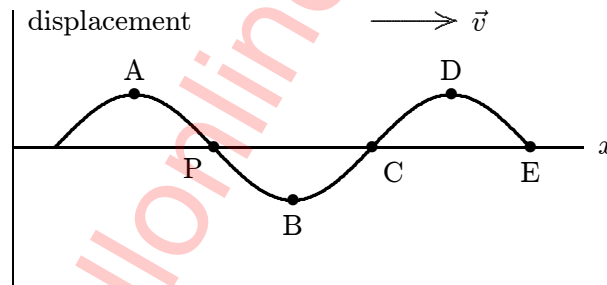

ans: C

15. The displacement of a string carrying a traveling sinusoidal wave is given by

$$y(x, t) = y_m \sin(kx - \omega t - \phi).$$

At time $t = 0$ the point at $x = 0$ has a displacement of 0 and is moving in the positive y direction. The phase constant ϕ is:

- A. 45°
- B. 90°
- C. 135°
- D. 180°
- E. 270°

ans: D

16. The displacement of a string carrying a traveling sinusoidal wave is given by

$$y(x, t) = y_m \sin(kx - \omega t - \phi).$$

At time $t = 0$ the point at $x = 0$ has a velocity of 0 and a positive displacement. The phase constant ϕ is:

- A. 45°
- B. 90°
- C. 135°
- D. 180°
- E. 270°

ans: E

17. The displacement of a string carrying a traveling sinusoidal wave is given by

$$y(x, t) = y_m \sin(kx - \omega t - \phi).$$

At time $t = 0$ the point at $x = 0$ has velocity v_0 and displacement y_0 . The phase constant ϕ is given by $\tan \phi =$:

- A. $v_0/\omega y_0$
- B. $\omega y_0/v_0$
- C. $\omega v_0/y_0$
- D. $y_0/\omega v_0$
- E. $\omega v_0 y_0$

ans: B

18. A sinusoidal transverse wave is traveling on a string. Any point on the string:

- A. moves in the same direction as the wave
- B. moves in simple harmonic motion with a different frequency than that of the wave
- C. moves in simple harmonic motion with the same angular frequency as the wave
- D. moves in uniform circular motion with a different angular speed than the wave
- E. moves in uniform circular motion with the same angular speed as the wave

ans: C

19. Here are the equations for three waves traveling on separate strings. Rank them according to the maximum transverse speed, least to greatest.

wave 1: $y(x, t) = (2.0 \text{ mm}) \sin[(4.0 \text{ m}^{-1})x - (3.0 \text{ s}^{-1})t]$

wave 2: $y(x, t) = (1.0 \text{ mm}) \sin[(8.0 \text{ m}^{-1})x - (4.0 \text{ s}^{-1})t]$

wave 3: $y(x, t) = (1.0 \text{ mm}) \sin[(4.0 \text{ m}^{-1})x - (8.0 \text{ s}^{-1})t]$

- A. 1, 2, 3
- B. 1, 3, 2
- C. 2, 1, 3
- D. 2, 3, 1
- E. 3, 1, 2

ans: C

20. The transverse wave shown is traveling from left to right in a medium. The direction of the instantaneous velocity of the medium at point P is:

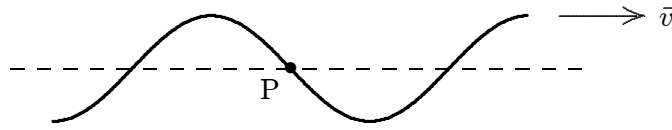

- A. \uparrow
 B. \downarrow
 C. \rightarrow
 D. \nearrow
 E. no direction since $v = 0$

ans: A

21. A wave traveling to the right on a stretched string is shown below. The direction of the instantaneous velocity of the point P on the string is:

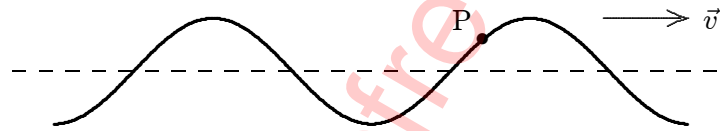

- A. \uparrow
 B. \downarrow
 C. \rightarrow
 D. \nearrow
 E. no direction since $v = 0$

ans: B

22. Sinusoidal waves travel on five different strings, all with the same tension. Four of the strings have the same linear mass density, but the fifth has a different linear mass density. Use the mathematical forms of the waves, given below, to identify the string with the different linear mass density. In the expressions x and y are in centimeters and t is in seconds.

- A. $y(x, t) = (2 \text{ cm}) \sin(2x - 4t)$
 B. $y(x, t) = (2 \text{ cm}) \sin(4x - 10t)$
 C. $y(x, t) = (2 \text{ cm}) \sin(6x - 12t)$
 D. $y(x, t) = (2 \text{ cm}) \sin(8x - 16t)$
 E. $y(x, t) = (2 \text{ cm}) \sin(10x - 20t)$

ans: B

23. Any point on a string carrying a sinusoidal wave is moving with its maximum speed when:

- A. the magnitude of its acceleration is a maximum
 B. the magnitude of its displacement is a maximum
 C. the magnitude of its displacement is a minimum
 D. the magnitude of its displacement is half the amplitude
 E. the magnitude of its displacement is one-fourth the amplitude

ans: C

24. The mathematical forms for three sinusoidal traveling waves are given by

wave 1: $y(x, t) = (2 \text{ cm}) \sin(3x - 6t)$

wave 2: $y(x, t) = (3 \text{ cm}) \sin(4x - 12t)$

wave 3: $y(x, t) = (4 \text{ cm}) \sin(5x - 11t)$

where x is in meters and t is in seconds. Of these waves:

- A. wave 1 has the greatest wave speed and the greatest maximum transverse string speed
- B. wave 2 has the greatest wave speed and wave 1 has the greatest maximum transverse string speed
- C. wave 3 has the greatest wave speed and the greatest maximum transverse string speed
- D. wave 2 has the greatest wave speed and wave 3 has the greatest maximum transverse string speed
- E. wave 3 has the greatest wave speed and wave 2 has the greatest maximum transverse string speed

ans: D

25. Suppose the maximum speed of a string carrying a sinusoidal wave is v_s . When the displacement of a point on the string is half its maximum, the speed of the point is:

- A. $v_s/2$
- B. $2v_s$
- C. $v_s/4$
- D. $3v_s/4$
- E. $\sqrt{3}v_s/2$

ans: E

26. A string carries a sinusoidal wave with an amplitude of 2.0 cm and a frequency of 100 Hz. The maximum speed of any point on the string is:

- A. 2.0 m/s
- B. 4.0 m/s
- C. 6.3 m/s
- D. 13 m/s
- E. unknown (not enough information is given)

ans: D

27. A transverse traveling sinusoidal wave on a string has a frequency of 100 Hz, a wavelength of 0.040 m, and an amplitude of 2.0 mm. The maximum velocity in m/s of any point on the string is:

- A. 0.2
- B. 1.3
- C. 4
- D. 15
- E. 25

ans: B

28. A transverse traveling sinusoidal wave on a string has a frequency of 100 Hz, a wavelength of 0.040 m, and an amplitude of 2.0 mm. The maximum acceleration in m/s^2 of any point on the string is:
- 0
 - 130
 - 395
 - 790
 - 1600

ans: D

29. The speed of a sinusoidal wave on a string depends on:
- the frequency of the wave
 - the wavelength of the wave
 - the length of the string
 - the tension in the string
 - the amplitude of the wave

ans: D

30. The time required for a small pulse to travel from A to B on a stretched cord shown is NOT altered by changing:
- the linear mass density of the cord
 - the length between A and B
 - the shape of the pulse
 - the tension in the cord
 - none of the above (changes in all alter the time)

ans: C

31. The diagrams show three identical strings that have been put under tension by suspending blocks of 5 kg each. For which is the wave speed the greatest?

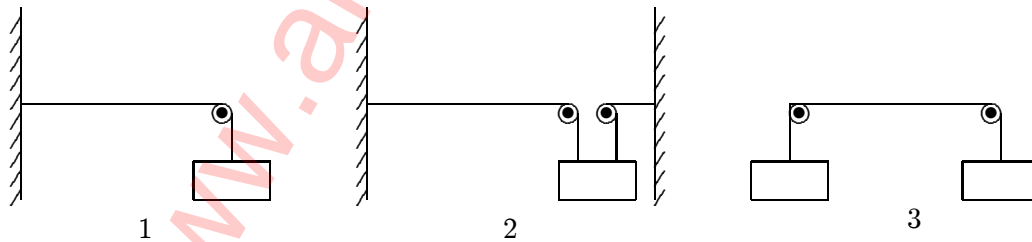

- 1
- 2
- 3
- 1 and 3 tie
- 2 and 3 tie

ans: D

32. For a given medium, the frequency of a wave is:
- A. independent of wavelength
 - B. proportional to wavelength
 - C. inversely proportional to wavelength
 - D. proportional to the amplitude
 - E. inversely proportional to the amplitude
- ans: C
33. The tension in a string with a linear mass density of 0.0010 kg/m is 0.40 N . A sinusoidal wave with a wavelength of 20 cm on this string has a frequency of:
- A. 0.0125 Hz
 - B. 0.25 Hz
 - C. 100 Hz
 - D. 630 Hz
 - E. 2000 Hz
- ans: C
34. When a 100-Hz oscillator is used to generate a sinusoidal wave on a certain string the wavelength is 10 cm . When the tension in the string is doubled the generator produces a wave with a frequency and wavelength of:
- A. 200 Hz and 20 cm
 - B. 141 Hz and 10 cm
 - C. 100 Hz and 20 cm
 - D. 100 Hz and 14 cm
 - E. 50 Hz and 14 cm
- ans: D
35. A source of frequency f sends waves of wavelength λ traveling with speed v in some medium. If the frequency is changed from f to $2f$, then the new wavelength and new speed are (respectively):
- A. $2\lambda, v$
 - B. $\lambda/2, v$
 - C. $\lambda, 2v$
 - D. $\lambda, v/2$
 - E. $\lambda/2, 2v$
- ans: B
36. A long string is constructed by joining the ends of two shorter strings. The tension in the strings is the same but string I has 4 times the linear mass density of string II. When a sinusoidal wave passes from string I to string II:
- A. the frequency decreases by a factor of 4
 - B. the frequency decreases by a factor of 2
 - C. the wavelength decreases by a factor of 4
 - D. the wavelength decreases by a factor of 2
 - E. the wavelength increases by a factor of 2
- ans: D

37. Three separate strings are made of the same material. String 1 has length L and tension τ , string 2 has length $2L$ and tension 2τ , and string 3 has length $3L$ and tension 3τ . A pulse is started at one end of each string. If the pulses start at the same time, the order in which they reach the other end is:
- A. 1, 2, 3
 - B. 3, 2, 1
 - C. 2, 3, 1
 - D. 3, 1, 2
 - E. they all take the same time
- ans: A
38. A long string is constructed by joining the ends of two shorter strings. The tension in the strings is the same but string I has 4 times the linear mass density of string II. When a sinusoidal wave passes from string I to string II:
- A. the frequency decreases by a factor of 4
 - B. the frequency decreases by a factor of 2
 - C. the wave speed decreases by a factor of 4
 - D. the wave speed decreases by a factor of 2
 - E. the wave speed increases by a factor of 2
- ans: E
39. Two identical but separate strings, with the same tension, carry sinusoidal waves with the same frequency. Wave A has a amplitude that is twice that of wave B and transmits energy at a rate that is _____ that of wave B.
- A. half
 - B. twice
 - C. one-fourth
 - D. four times
 - E. eight times
- ans: D
40. Two identical but separate strings, with the same tension, carry sinusoidal waves with the same frequency. Wave A has an amplitude that is twice that of wave B and transmits energy at a rate that is _____ that of wave B.
- A. half
 - B. twice
 - C. one-fourth
 - D. four times
 - E. eight times
- ans: D

41. A sinusoidal wave is generated by moving the end of a string up and down periodically. The generator must supply the greatest power when the end of the string
- A. has its greatest acceleration
 - B. has its greatest displacement
 - C. has half its greatest displacement
 - D. has one-fourth its greatest displacement
 - E. has its least displacement

ans: E

42. A sinusoidal wave is generated by moving the end of a string up and down periodically. The generator does not supply any power when the end of the string
- A. has its least acceleration
 - B. has its greatest displacement
 - C. has half its greatest displacement
 - D. has one-fourth its greatest displacement
 - E. has its least displacement

ans: B

43. The sum of two sinusoidal traveling waves is a sinusoidal traveling wave only if:
- A. their amplitudes are the same and they travel in the same direction.
 - B. their amplitudes are the same and they travel in opposite directions.
 - C. their frequencies are the same and they travel in the same direction.
 - D. their frequencies are the same and they travel in opposite directions.
 - E. their frequencies are the same and their amplitudes are the same.

ans: C

44. Two traveling sinusoidal waves interfere to produce a wave with the mathematical form

$$y(x, t) = y_m \sin(kx + \omega t + \alpha).$$

If the value of ϕ is appropriately chosen, the two waves might be:

- A. $y_1(x, t) = (y_m/3) \sin(kx + \omega t)$ and $y_2(x, t) = (y_m/3) \sin(kx + \omega t + \phi)$
- B. $y_1(x, t) = 0.7y_m \sin(kx - \omega t)$ and $y_2(x, t) = 0.7y_m \sin(kx - \omega t + \phi)$
- C. $y_1(x, t) = 0.7y_m \sin(kx - \omega t)$ and $y_2(x, t) = 0.7y_m \sin(kx + \omega t + \phi)$
- D. $y_1(x, t) = 0.7y_m \sin[(kx/2) - (\omega t/2)]$ and $y_2(x, t) = 0.7y_m \sin[(kx/2) - (\omega t/2) + \phi]$
- E. $y_1(x, t) = 0.7y_m \sin(kx + \omega t)$ and $y_2(x, t) = 0.7y_m \sin(kx + \omega t + \phi)$

ans: E

45. Fully constructive interference between two sinusoidal waves of the same frequency occurs only if they:
- A. travel in opposite directions and are in phase
 - B. travel in opposite directions and are 180° out of phase
 - C. travel in the same direction and are in phase
 - D. travel in the same direction and are 180° out of phase
 - E. travel in the same direction and are 90° out of phase

ans: C

46. Fully destructive interference between two sinusoidal waves of the same frequency and amplitude occurs only if they:
- A. travel in opposite directions and are in phase
 - B. travel in opposite directions and are 180° out of phase
 - C. travel in the same direction and are in phase
 - D. travel in the same direction and are 180° out of phase
 - E. travel in the same direction and are 90° out of phase
- ans: D
47. Two sinusoidal waves travel in the same direction and have the same frequency. Their amplitudes are y_{1m} and y_{2m} . The smallest possible amplitude of the resultant wave is:
- A. $y_{1m} + y_{2m}$ and occurs if they are 180° out of phase
 - B. $|y_{1m} - y_{2m}|$ and occurs if they are 180° out of phase
 - C. $y_{1m} + y_{2m}$ and occurs if they are in phase
 - D. $|y_{1m} - y_{2m}|$ and occurs if they are in phase
 - E. $|y_{1m} - y_{2m}|$ and occurs if they are 90° out of phase
- ans: B
48. Two sinusoidal waves have the same angular frequency, the same amplitude y_m , and travel in the same direction in the same medium. If they differ in phase by 50° , the amplitude of the resultant wave is given by:
- A. $0.64y_m$
 - B. $1.3y_m$
 - C. $0.91y_m$
 - D. $1.8y_m$
 - E. $0.35y_m$
- ans: D
49. Two separated sources emit sinusoidal traveling waves that have the same wavelength λ and are in phase at their respective sources. One travels a distance ℓ_1 to get to the observation point while the other travels a distance ℓ_2 . The amplitude is a minimum at the observation point if $\ell_1 - \ell_2$ is:
- A. an odd multiple of $\lambda/2$
 - B. an odd multiple of $\lambda/4$
 - C. a multiple of λ
 - D. an odd multiple of $\pi/2$
 - E. a multiple of π
- ans: A

50. Two separated sources emit sinusoidal traveling waves that have the same wavelength λ and are in phase at their respective sources. One travels a distance ℓ_1 to get to the observation point while the other travels a distance ℓ_2 . The amplitude is a maximum at the observation point if $\ell_1 - \ell_2$ is:
- an odd multiple of $\lambda/2$
 - an odd multiple of $\lambda/4$
 - a multiple of λ
 - an odd multiple of $\pi/2$
 - a multiple of π

ans: C

51. Two sources, S_1 and S_2 , each emit waves of wavelength λ in the same medium. The phase difference between the two waves, at the point P shown, is $(2\pi/\lambda)(\ell_2 - \ell_1) + \epsilon$. The quantity ϵ is:

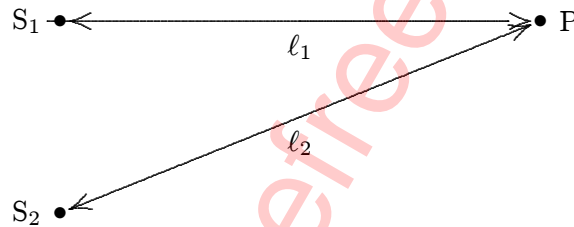

- the distance S_1S_2
- the angle S_1PS_2
- $\pi/2$
- the phase difference between the two sources
- zero for transverse waves, π for longitudinal waves

ans: D

52. A wave on a stretched string is reflected from a fixed end P of the string. The phase difference, at P, between the incident and reflected waves is:
- zero
 - π rad
 - $\pi/2$ rad
 - depends on the velocity of the wave
 - depends on the frequency of the wave

ans: B

53. The sinusoidal wave

$$y(x, t) = y_m \sin(kx - \omega t)$$

is incident on the fixed end of a string at $x = L$. The reflected wave is given by:

- $y_m \sin(kx + \omega t)$
- $-y_m \sin(kx + \omega t)$
- $y_m \sin(kx + \omega t - kL)$
- $y_m \sin(kx + \omega t - 2kL)$
- $-y_m \sin(kx + \omega t + 2kL)$

ans: D

54. A wave on a string is reflected from a fixed end. The reflected wave:
- is in phase with the original wave at the end
 - is 180° out of phase with the original wave at the end
 - has a larger amplitude than the original wave
 - has a larger speed than the original wave
 - cannot be transverse
- ans: B
55. A standing wave:
- can be constructed from two similar waves traveling in opposite directions
 - must be transverse
 - must be longitudinal
 - has motionless points that are closer than half a wavelength
 - has a wave velocity that differs by a factor of two from what it would be for a traveling wave
- ans: A
56. Which of the following represents a standing wave?
- $y = (6.0 \text{ mm}) \sin[(3.0 \text{ m}^{-1})x + (2.0 \text{ s}^{-1})t] - (6.0 \text{ mm}) \cos[(3.0 \text{ m}^{-1})x + 2.0]$
 - $y = (6.0 \text{ mm}) \cos[(3.0 \text{ m}^{-1})x - (2.0 \text{ s}^{-1})t] + (6.0 \text{ mm}) \cos[(2.0 \text{ s}^{-1})t + 3.0 \text{ m}^{-1}x]$
 - $y = (6.0 \text{ mm}) \cos[(3.0 \text{ m}^{-1})x - (2.0 \text{ s}^{-1})t] - (6.0 \text{ mm}) \sin[(2.0 \text{ s}^{-1})t - 3.0]$
 - $y = (6.0 \text{ mm}) \sin[(3.0 \text{ m}^{-1})x - (2.0 \text{ s}^{-1})t] - (6.0 \text{ mm}) \cos[(2.0 \text{ s}^{-1})t + 3.0 \text{ m}^{-1}x]$
 - $y = (6.0 \text{ mm}) \sin[(3.0 \text{ m}^{-1})x] + (6.0 \text{ mm}) \cos[(2.0 \text{ s}^{-1})t]$
- ans: B
57. When a certain string is clamped at both ends, the lowest four resonant frequencies are 50, 100, 150, and 200 Hz. When the string is also clamped at its midpoint, the lowest four resonant frequencies are:
- 50, 100, 150, and 200 Hz
 - 50, 150, 250, and 300 Hz
 - 100, 200, 300, and 400 Hz
 - 25, 50, 75, and 100 Hz
 - 75, 150, 225, and 300 Hz
- ans: C
58. When a certain string is clamped at both ends, the lowest four resonant frequencies are measured to be 100, 150, 200, and 250 Hz. One of the resonant frequencies (below 200 Hz) is missing. What is it?
- 25 Hz
 - 50 Hz
 - 75 Hz
 - 125 Hz
 - 225 Hz
- ans: B

59. Two traveling waves $y_1 = A \sin[k(x - vt)]$ and $y_2 = A \sin[k(x + vt)]$ are superposed on the same string. The distance between the adjacent nodes is:
- vt/π
 - $vt/2\pi$
 - $\pi/2k$
 - π/k
 - $2\pi/k$
- ans: D

60. If λ is the wavelength of each of the component sinusoidal traveling waves that form a standing wave, the distance between adjacent nodes in the standing wave is:
- $\lambda/4$
 - $\lambda/2$
 - $3\lambda/4$
 - λ
 - 2λ
- ans: B

61. A standing wave pattern is established in a string as shown. The wavelength of one of the component traveling waves is:

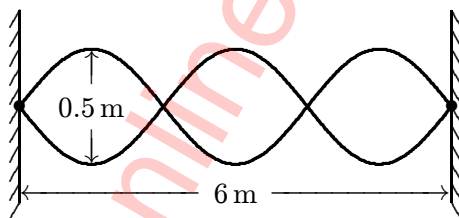

- 0.25 m
 - 0.5 m
 - 1 m
 - 2 m
 - 4 m
- ans: E
62. Standing waves are produced by the interference of two traveling sinusoidal waves, each of frequency 100 Hz. The distance from the second node to the fifth node is 60 cm. The wavelength of each of the two original waves is:
- 50 cm
 - 40 cm
 - 30 cm
 - 20 cm
 - 15 cm
- ans: B

63. A string of length 100 cm is held fixed at both ends and vibrates in a standing wave pattern. The wavelengths of the constituent traveling waves CANNOT be:
- A. 400 cm
 - B. 200 cm
 - C. 100 cm
 - D. 66.7 cm
 - E. 50 cm
- ans: A
64. A string of length L is clamped at each end and vibrates in a standing wave pattern. The wavelengths of the constituent traveling waves CANNOT be:
- A. L
 - B. $2L$
 - C. $L/2$
 - D. $2L/3$
 - E. $4L$
- ans: E
65. Two sinusoidal waves, each of wavelength 5 m and amplitude 10 cm, travel in opposite directions on a 20-m long stretched string that is clamped at each end. Excluding the nodes at the ends of the string, how many nodes appear in the resulting standing wave?
- A. 3
 - B. 4
 - C. 5
 - D. 7
 - E. 8
- ans: D
66. A string, clamped at its ends, vibrates in three segments. The string is 100 cm long. The wavelength is:
- A. 33.3 cm
 - B. 66.7 cm
 - C. 150 cm
 - D. 300 cm
 - E. need to know the frequency
- ans: B
67. A stretched string, clamped at its ends, vibrates in its fundamental frequency. To double the fundamental frequency, one can change the string tension by a factor of:
- A. 2
 - B. 4
 - C. $\sqrt{2}$
 - D. $1/2$
 - E. $1/\sqrt{2}$
- ans: B

68. When a string is vibrating in a standing wave pattern the power transmitted across an antinode, compared to the power transmitted across a node, is:
- A. more
 - B. less
 - C. the same (zero)
 - D. the same (non-zero)
 - E. sometimes more, sometimes less, and sometimes the same
- ans: C
69. A 40-cm long string, with one end clamped and the other free to move transversely, is vibrating in its fundamental standing wave mode. The wavelength of the constituent traveling waves is:
- A. 10 cm
 - B. 20 cm
 - C. 40 cm
 - D. 80 cm
 - E. 160 cm
- ans: E
70. A 30-cm long string, with one end clamped and the other free to move transversely, is vibrating in its second harmonic. The wavelength of the constituent traveling waves is:
- A. 10 cm
 - B. 30 cm
 - C. 40 cm
 - D. 60 cm
 - E. 120 cm
- ans: C
71. A 40-cm long string, with one end clamped and the other free to move transversely, is vibrating in its fundamental standing wave mode. If the wave speed is 320 cm/s the frequency is:
- A. 32 Hz
 - B. 16 Hz
 - C. 8 Hz
 - D. 4 Hz
 - E. 2 Hz
- ans: E

Chapter 17: WAVES — II

- The speed of a sound wave is determined by:
 - its amplitude
 - its intensity
 - its pitch
 - number of harmonics present
 - the transmitting mediumans: E
- Take the speed of sound to be 340 m/s. A thunder clap is heard about 3 s after the lightning is seen. The source of both light and sound is:
 - moving overhead faster than the speed of sound
 - emitting a much higher frequency than is heard
 - emitting a much lower frequency than is heard
 - about 1000 m away
 - much more than 1000 m awayans: D
- A sound wave has a wavelength of 3.0 m. The distance from a compression center to the adjacent rarefaction center is:
 - 0.75 m
 - 1.5 m
 - 3.0 m
 - need to know wave speed
 - need to know frequencyans: B
- A fire whistle emits a tone of 170 Hz. Take the speed of sound in air to be 340 m/s. The wavelength of this sound is about:
 - 0.5 m
 - 1.0 m
 - 2.0 m
 - 3.0 m
 - 340 mans: C
- During a time interval of exactly one period of vibration of a tuning fork, the emitted sound travels a distance:
 - equal to the length of the tuning fork
 - equal to twice the length of the tuning fork
 - of about 330 m
 - which decreases with time
 - of one wavelength in airans: E

6. At points in a sound wave where the gas is maximally compressed, the pressure
- A. is a maximum
 - B. is a minimum
 - C. is equal to the ambient value
 - D. is greater than the ambient value but less than the maximum
 - E. is less than the ambient value but greater than the minimum

ans: A

7. You are listening to an “A” note played on a violin string. Let the subscript “s” refer to the violin string and “a” refer to the air. Then:
- A. $f_s = f_a$ but $\lambda_s \neq \lambda_a$
 - B. $f_s = f_a$ and $\lambda_s = \lambda_a$
 - C. $\lambda_s = \lambda_a$ but $f_s \neq f_a$
 - D. $\lambda_s \neq \lambda_a$ and $f_s \neq f_a$
 - E. linear density of string = volume density of air

ans: A

8. “Beats” in sound refer to:
- A. interference of two waves of the same frequency
 - B. combination of two waves of slightly different frequency
 - C. reversal of phase of reflected wave relative to incident wave
 - D. two media having slightly different sound velocities
 - E. effect of relative motion of source and observer

ans: B

9. To produce beats it is necessary to use two waves:
- A. traveling in opposite directions
 - B. of slightly different frequencies
 - C. of equal wavelengths
 - D. of equal amplitudes
 - E. whose ratio of frequencies is an integer

ans: B

10. In order for two sound waves to produce audible beats, it is essential that the two waves have:
- A. the same amplitude
 - B. the same frequency
 - C. the same number of harmonics
 - D. slightly different amplitudes
 - E. slightly different frequencies

ans: E

11. The largest number of beats per second will be heard from which pair of tuning forks?
- A. 200 and 201 Hz
 - B. 256 and 260 Hz
 - C. 534 and 540 Hz
 - D. 763 and 774 Hz
 - E. 8420 and 8422 Hz
- ans: D
12. Two stationary tuning forks (350 and 352 Hz) are struck simultaneously. The resulting sound is observed to:
- A. beat with a frequency of 2 beats/s
 - B. beat with a frequency of 351 beats/s
 - C. be loud but not beat
 - D. be Doppler shifted by 2 Hz
 - E. have a frequency of 702 Hz
- ans: A
13. When listening to tuning forks of frequency 256 Hz and 260 Hz, one hears the following number of beats per second:
- A. zero
 - B. 2
 - C. 4
 - D. 8
 - E. 258
- ans: C
14. Two identical tuning forks vibrate at 256 Hz. One of them is then loaded with a drop of wax, after which 6 beats/s are heard. The period of the loaded tuning fork is:
- A. 0.006 s
 - B. 0.005 s
 - C. 0.004 s
 - D. 0.003 s
 - E. none of these
- ans: C
15. Which of the following properties of a sound wave determine its “pitch”?
- A. Amplitude
 - B. Distance from source to detector
 - C. Frequency
 - D. Phase
 - E. Speed
- ans: C

16. Two notes are an “octave” apart. The ratio of their frequencies is:
- A. 8
 - B. 10
 - C. $\sqrt{8}$
 - D. 2
 - E. $\sqrt{2}$
- ans: D
17. Consider two imaginary spherical surfaces with different radii, each centered on a point sound source emitting spherical waves. The power transmitted across the larger sphere is _____ the power transmitted across the smaller and the intensity at a point on the larger sphere is _____ the intensity at a point on the smaller.
- A. greater than, the same as
 - B. greater than, greater than
 - C. greater than, less than
 - D. the same as, less than
 - E. the same as, the same as
- ans: D
18. The sound intensity 5.0 m from a point source is 0.50 W/m^2 . The power output of the source is:
- A. 39 W
 - B. 160 W
 - C. 266 W
 - D. 320 W
 - E. 390 W
- ans: B
19. The standard reference sound level is about:
- A. the threshold of human hearing at 1000 Hz
 - B. the threshold of pain for human hearing at 1000 Hz
 - C. the level of sound produced when the 1 kg standard mass is dropped 1 m onto a concrete floor
 - D. the level of normal conversation
 - E. the level of sound emitted by a standard 60 Hz tuning fork
- ans: A
20. The intensity of sound wave A is 100 times that of sound wave B. Relative to wave B the sound level of wave A is:
- A. -2 db
 - B. $+2 \text{ db}$
 - C. $+10 \text{ db}$
 - D. $+20 \text{ db}$
 - E. $+100 \text{ db}$
- ans: D

21. The intensity of a certain sound wave is $6 \mu\text{W}/\text{cm}^2$. If its intensity is raised by 10 db, the new intensity (in $\mu\text{W}/\text{cm}^2$) is:
- A. 60
 - B. 6.6
 - C. 6.06
 - D. 600
 - E. 12
- ans: A
22. If the sound level is increased by 10 db the intensity increases by a factor of:
- A. 2
 - B. 5
 - C. 10
 - D. 20
 - E. 100
- ans: C
23. The sound level at a point P is 14 db below the sound level at a point 1.0 m from a point source. The distance from the source to point P is:
- A. 4.0 cm
 - B. 20.2 m
 - C. 2.0 m
 - D. 5.0 m
 - E. 25 m
- ans: D
24. To raise the pitch of a certain piano string, the piano tuner:
- A. loosens the string
 - B. tightens the string
 - C. shortens the string
 - D. lengthens the string
 - E. removes some mass
- ans: B
25. A piano wire has length L and mass M . If its fundamental frequency is f , its tension is:
- A. $2Lf/m$
 - B. $4MLf$
 - C. $2Mf^2/L$
 - D. $4f^2L^3/M$
 - E. $4LMf^2$
- ans: E

26. If the length of a piano wire (of given density) is increased by 5%, what approximate change in tension is necessary to keep its fundamental frequency unchanged?
- Decrease of 10%
 - Decrease of 5%
 - Increase of 5%
 - Increase of 10%
 - Increase of 20%

ans: C

27. A piano wire has a length of 81 cm and a mass of 2.0 g. If its fundamental frequency is to be 394 Hz, its tension must be:
- 0.32 N
 - 63 N
 - 130 N
 - 250 N
 - none of these

ans: B

28. A stretched wire of length 1.0 m is clamped at both ends. It is plucked at its center as shown. The three longest wavelengths in the wire are (in meters):

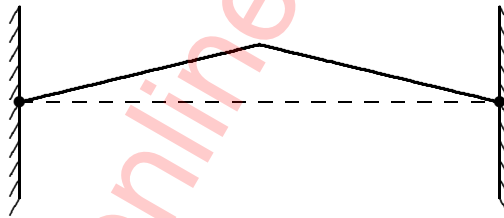

- 4, 2, 1
- 2, 1, 0.5
- 2, 0.67, 0.4
- 1, 0.5, 0.33
- 1, 0.67, 0.5

ans: C

29. Two identical strings, A and B, have nearly the same tension. When they both vibrate in their fundamental resonant modes, there is a beat frequency of 3 Hz. When string B is tightened slightly, to increase the tension, the beat frequency becomes 6 Hz. This means:
- that before tightening A had a higher frequency than B, but after tightening, B has a higher frequency than A
 - that before tightening B had a higher frequency than A, but after tightening, A has a higher frequency than B
 - that before and after tightening A has a higher frequency than B
 - that before and after tightening B has a higher frequency than A
 - none of the above

ans: D

30. Two pipes are each open at one end and closed at the other. Pipe A has length L and pipe B has length $2L$. Which harmonic of pipe B matches in frequency the fundamental of pipe A?
- A. The fundamental
 - B. The second
 - C. The third
 - D. The fourth
 - E. There are none

ans: E

31. A column of argon is open at one end and closed at the other. The shortest length of such a column that will resonate with a 200 Hz tuning fork is 42.5 cm. The speed of sound in argon must be:
- A. 85.0 m/s
 - B. 170 m/s
 - C. 340 m/s
 - D. 470 m/s
 - E. 940 m/s

ans: C

32. A tuning fork produces sound waves of wavelength λ in air. This sound is used to cause resonance in an air column, closed at one end and open at the other. The length of this column CANNOT be:
- A. $\lambda/4$
 - B. $2\lambda/4$
 - C. $3\lambda/4$
 - D. $5\lambda/4$
 - E. $7\lambda/4$

ans: B

33. A 1024 Hz tuning fork is used to obtain a series of resonance levels in a gas column of variable length, with one end closed and the other open. The length of the column changes by 20 cm from resonance to resonance. From this data, the speed of sound in this gas is:
- A. 20 cm/s
 - B. 51 cm/s
 - C. 102 cm/s
 - D. 205 m/s
 - E. 410 m/s

ans: E

34. A vibrating tuning fork is held over a water column with one end closed and the other open. As the water level is allowed to fall, a loud sound is heard for water levels separated by 17 cm. If the speed of sound in air is 340 m/s, the frequency of the tuning fork is:
- A. 500 Hz
 - B. 1000 Hz
 - C. 2000 Hz
 - D. 5780 Hz
 - E. 578,000 Hz

ans: B

35. An organ pipe with one end open and the other closed is operating at one of its resonant frequencies. The open and closed ends are respectively:
- A. pressure node, pressure node
 - B. pressure node, displacement node
 - C. displacement antinode, pressure node
 - D. displacement node, displacement node
 - E. pressure antinode, pressure node
- ans: B
36. An organ pipe with one end closed and the other open has length L . Its fundamental frequency is proportional to:
- A. L
 - B. $1/L$
 - C. $1/L^2$
 - D. L^2
 - E. \sqrt{L}
- ans: B
37. Five organ pipes are described below. Which one has the highest frequency fundamental?
- A. A 2.3-m pipe with one end open and the other closed
 - B. A 3.3-m pipe with one end open and the other closed
 - C. A 1.6-m pipe with both ends open
 - D. A 3.0-m pipe with both ends open
 - E. A pipe in which the displacement nodes are 5 m apart
- ans: C
38. If the speed of sound is 340 m/s, the length of the shortest closed pipe that resonates at 218 Hz is:
- A. 23 cm
 - B. 17 cm
 - C. 39 cm
 - D. 78 cm
 - E. 1.56 cm
- ans: C
39. The lowest tone produced by a certain organ comes from a 3.0-m pipe with both ends open. If the speed of sound is 340 m/s, the frequency of this tone is approximately:
- A. 7 Hz
 - B. 14 Hz
 - C. 28 Hz
 - D. 57 Hz
 - E. 70 Hz
- ans: D

40. The speed of sound in air is 340 m/s. The length of the shortest pipe, closed at one end, that will respond to a 512 Hz tuning fork is approximately:
- A. 4.2 cm
 - B. 9.4 cm
 - C. 17 cm
 - D. 33 cm
 - E. 66 cm
- ans: C

41. If the speed of sound is 340 m/s, the two lowest frequencies of an 0.5-m organ pipe, closed at one end, are approximately:
- A. 170 and 340 Hz
 - B. 170 and 510 Hz
 - C. 340 and 680 Hz
 - D. 340 and 1020 Hz
 - E. 57 and 170 Hz
- ans: B

42. Organ pipe Y (open at both ends) is half as long as organ pipe X (open at one end) as shown. The ratio of their fundamental frequencies $f_X:f_Y$ is:

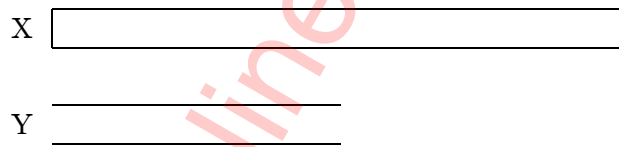

- A. 1:1
 - B. 1:2
 - C. 2:1
 - D. 1:4
 - E. 4:1
- ans: A
43. A 200-cm organ pipe with one end open is in resonance with a sound wave of wavelength 270 cm. The pipe is operating in its:
- A. fundamental frequency
 - B. second harmonic
 - C. third harmonic
 - D. fourth harmonic
 - E. fifth harmonic
- ans: B

44. An organ pipe with both ends open is 0.85 m long. Assuming that the speed of sound is 340 m/s, the frequency of the third harmonic of this pipe is:
- 200 Hz
 - 300 Hz
 - 400 Hz
 - 600 Hz
 - none of these

ans: D

45. The “A” on a trumpet and a clarinet have the same pitch, but the two are clearly distinguishable. Which property is most important in enabling one to distinguish between these two instruments?
- Intensity
 - Fundamental frequency
 - Displacement amplitude
 - Pressure amplitude
 - Harmonic content

ans: E

46. The valves of a trumpet and the slide of a trombone are for the purpose of:
- playing short (staccato) notes
 - tuning the instruments
 - changing the harmonic content
 - changing the length of the air column
 - producing gradations in loudness

ans: D

47. Two small identical speakers are connected (in phase) to the same source. The speakers are 3 m apart and at ear level. An observer stands at X, 4 m in front of one speaker as shown. If the amplitudes are not changed, the sound he hears will be most intense if the wavelength is:

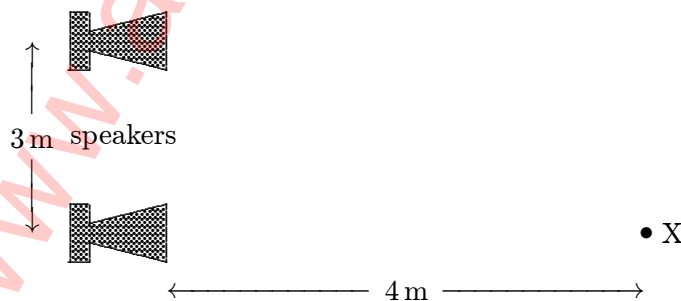

- 1 m
- 2 m
- 3 m
- 4 m
- 5 m

ans: A

48. Two small identical speakers are connected (in phase) to the same source. The speakers are 3 m apart and at ear level. An observer stands at X, 4 m in front of one speaker as shown. The sound she hears will be most intense if the wavelength is:

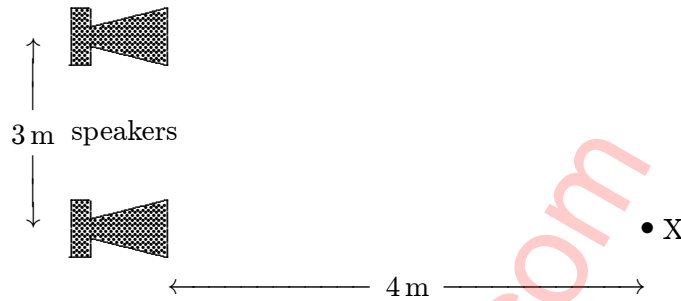

- A. 5 m
- B. 4 m
- C. 3 m
- D. 2 m
- E. 1 m

ans: E

49. The rise in pitch of an approaching siren is an apparent increase in its:
- A. speed
 - B. amplitude
 - C. frequency
 - D. wavelength
 - E. number of harmonics

ans: C

50. The diagram shows four situations in which a source of sound S with variable frequency and a detector D are either moving or stationary. The arrows indicate the directions of motion. The speeds are all the same. Detector 3 is stationary. The frequency detected is the same. Rank the situations according to the frequency of the source, lowest to highest.



- A. 1, 2, 3, 4
- B. 4, 3, 2, 1
- C. 1, 3, 4, 2
- D. 2, 1, 2, 3
- E. None of the above

ans: B

51. A stationary source generates 5.0 Hz water waves whose speed is 2.0 m/s. A boat is approaching the source at 10 m/s. The frequency of these waves, as observed by a person in the boat, is:
- A. 5.0 Hz
 - B. 15 Hz
 - C. 20 Hz
 - D. 25 Hz
 - E. 30 Hz
- ans: E
52. A stationary source S generates circular outgoing waves on a lake. The wave speed is 5.0 m/s and the crest-to-crest distance is 2.0 m. A person in a motor boat heads directly toward S at 3.0 m/s. To this person, the frequency of these waves is:
- A. 1.0 Hz
 - B. 1.5 Hz
 - C. 2.0 Hz
 - D. 4.0 Hz
 - E. 8.0 Hz
- ans: D
53. A stationary source emits a sound wave of frequency f . If it were possible for a man to travel toward the source at the speed of sound, he would observe the emitted sound to have a frequency of:
- A. zero
 - B. $f/2$
 - C. $2f/3$
 - D. $2f$
 - E. infinity
- ans: D
54. A source emits sound with a frequency of 1000 Hz. It and an observer are moving in the same direction with the same speed, 100 m/s. If the speed of sound is 340 m/s, the observer hears sound with a frequency of:
- A. 294 Hz
 - B. 545 Hz
 - C. 1000 Hz
 - D. 1830 Hz
 - E. 3400 Hz
- ans: C
55. A source emits sound with a frequency of 1000 Hz. It and an observer are moving toward each other, each with a speed of 100 m/s. If the speed of sound is 340 m/s, the observer hears sound with a frequency of:
- A. 294 Hz
 - B. 545 Hz
 - C. 1000 Hz
 - D. 1830 Hz
 - E. 3400 Hz
- ans: D

56. A source emits sound with a frequency of 1000 Hz. It is moving at 20 m/s toward a stationary reflecting wall. If the speed of sound is 340 m/s an observer at rest directly behind the source hears a beat frequency of:
- 11 Hz
 - 86 Hz
 - 97 Hz
 - 118 Hz
 - 183 Hz

ans: D

57. In each of the following two situations a source emits sound with a frequency of 1000 Hz. In situation I the source is moving at 100 m/s toward an observer at rest. In situation II the observer is moving at 100 m/s toward the source, which is stationary. The speed of sound is 340 m/s. The frequencies heard by the observers in the two situations are:

- I: 1417 Hz; II: 1294 Hz
- I: 1417 Hz; II: 1417 Hz
- I: 1294 Hz; II: 1294 Hz
- I: 773 Hz; II: 706 Hz
- I: 773 Hz; II: 773 Hz

ans: A

58. The Doppler shift formula for the frequency detected is

$$f = f' \frac{v \pm v_D}{v \mp v_S},$$

where f' is the frequency emitted, v is the speed of sound, v_D is the speed of the detector, and v_S is the speed of the source. Suppose the source is traveling at 5 m/s away from the detector, the detector is traveling at 7 m/s toward the source, and there is a 3-m/s wind blowing from the source toward the detector. The values that should be substituted into the Doppler shift equation are:

- $v_D = 7$ m/s and $v_S = 5$ m/s
- $v_D = 10$ m/s and $v_S = 8$ m/s
- $v_D = 4$ m/s and $v_S = 2$ m/s
- $v_D = 10$ m/s and $v_S = 2$ m/s
- $v_D = 4$ m/s and $v_S = 8$ m/s

ans: B

59. A plane produces a sonic boom only when:
- it emits sound waves of very long wavelength
 - it emits sound waves of high frequency
 - it flies at high altitudes
 - it flies on a curved path
 - it flies faster than the speed of sound

ans: E

60. If the speed of sound is 340 m/s a plane flying at 400 m/s creates a conical shock wave with an apex half angle of:
- A. 0 (no shock wave)
 - B. 32°
 - C. 40°
 - D. 50°
 - E. 58°
- ans: E

61. The speed of sound is 340 m/s. A plane flies horizontally at an altitude of 10,000 m and a speed of 400 m/s. When an observer on the ground hears the sonic boom the horizontal distance from the point on its path directly above the observer to the plane is:
- A. 5800 m
 - B. 6200 m
 - C. 8400 m
 - D. 12,000 m
 - E. 16,000 m
- ans: B

www.allonlinefree.com

**Chapter 19: TEMPERATURE, HEAT,
AND THE FIRST LAW OF THERMODYNAMICS**

1. If two objects are in thermal equilibrium with each other:
 - A. they cannot be moving
 - B. they cannot be undergoing an elastic collision
 - C. they cannot have different pressures
 - D. they cannot be at different temperatures
 - E. they cannot be falling in Earth's gravitational fieldans: D

2. When two gases separated by a diathermal wall are in thermal equilibrium with each other:
 - A. only their pressures must be the same
 - B. only their volumes must be the same
 - C. they must have the same number of particles
 - D. they must have the same pressure and the same volume
 - E. only their temperatures must be the sameans: E

3. A balloon is filled with cold air and placed in a warm room. It is NOT in thermal equilibrium with the air of the room until:
 - A. it rises to the ceiling
 - B. it sinks to the floor
 - C. it stops expanding
 - D. it starts to contract
 - E. none of the aboveans: C

4. Suppose object C is in thermal equilibrium with object A and with object B. The zeroth law of thermodynamics states:
 - A. that C will always be in thermal equilibrium with both A and B
 - B. that C must transfer energy to both A and B
 - C. that A is in thermal equilibrium with B
 - D. that A cannot be in thermal equilibrium with B
 - E. nothing about the relationship between A and Bans: C

5. The zeroth law of thermodynamics allows us to define:
 - A. work
 - B. pressure
 - C. temperature
 - D. thermal equilibrium
 - E. internal energyans: C

6. If the zeroth law of thermodynamics were not valid, which of the following could not be considered a property of an object?
- A. Pressure
 - B. Center of mass energy
 - C. Internal energy
 - D. Momentum
 - E. Temperature
- ans: E
7. The international standard thermometer is kept:
- A. near Washington, D.C.
 - B. near Paris, France
 - C. near the north pole
 - D. near Rome, Italy
 - E. nowhere (there is none)
- ans: E
8. In constructing a thermometer it is NECESSARY to use a substance that:
- A. expands with rising temperature
 - B. expands linearly with rising temperature
 - C. will not freeze
 - D. will not boil
 - E. undergoes some change when heated or cooled
- ans: E
9. The “triple point” of a substance is that point for which the temperature and pressure are such that:
- A. only solid and liquid are in equilibrium
 - B. only liquid and vapor are in equilibrium
 - C. only solid and vapor are in equilibrium
 - D. solid, liquid, and vapor are all in equilibrium
 - E. the temperature, pressure and density are all numerically equal
- ans: D
10. Constant-volume gas thermometers using different gases all indicate nearly the same temperature when in contact with the same object if:
- A. the volumes are all extremely large
 - B. the volumes are all the same
 - D. the pressures are all extremely large
 - C. the pressures are the same
 - E. the particle concentrations are all extremely small
- ans: E

11. A constant-volume gas thermometer is used to measure the temperature of an object. When the thermometer is in contact with water at its triple point (273.16 K) the pressure in the thermometer is 8.500×10^4 Pa. When it is in contact with the object the pressure is 9.650×10^4 Pa. The temperature of the object is:
- 37.0 K
 - 241 K
 - 310 K
 - 314 K
 - 2020 K
- ans: C

12. When a certain constant-volume gas thermometer is in thermal contact with water at its triple point (273.16 K) the pressure is 6.30×10^4 Pa. For this thermometer a kelvin corresponds to a change in pressure of about:
- 4.34×10^2 Pa
 - 2.31×10^2 Pa
 - 1.72×10^3 Pa
 - 2.31×10^3 Pa
 - 1.72×10^7 Pa
- ans: B

13. The diagram shows four thermometers, labeled W, X, Y, and Z. The freezing and boiling points of water are indicated. Rank the thermometers according to the size of a degree on their scales, smallest to largest.

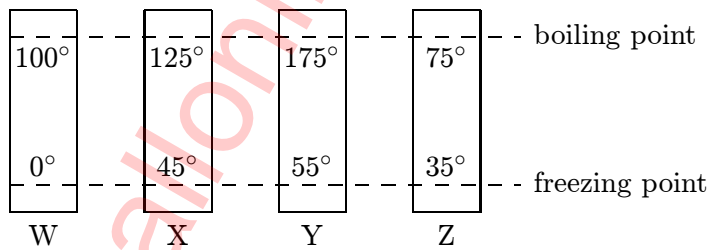

- W, X, Y, Z
 - Z, Y, X, W
 - Z, Y, W, X
 - Z, X, W, Y
 - W, Y, Z, X
- ans: D
14. There is a temperature at which the reading on the Kelvin scale is numerically:
- equal to that on the Celsius scale
 - lower than that on the Celsius scale
 - equal to that on the Fahrenheit scale
 - less than zero
 - none of the above
- ans: C

15. Fahrenheit and Kelvin scales agree numerically at a reading of:
- A. -40
 - B. 0
 - C. 273
 - D. 301
 - E. 574
- ans: E
16. Which one of the following statements is true?
- A. Temperatures differing by 25° on the Fahrenheit scale must differ by 45° on the Celsius scale
 - B. 40 K corresponds to -40°C
 - C. Temperatures which differ by 10° on the Celsius scale must differ by 18° on the Fahrenheit scale
 - D. Water at 90°C is warmer than water at 202°F
 - E. 0°F corresponds to -32°C
- ans: C
17. A Kelvin thermometer and a Fahrenheit thermometer both give the same reading for a certain sample. The corresponding Celsius temperature is:
- A. 574°C
 - B. 232°C
 - C. 301°C
 - D. 614°C
 - E. 276°C
- ans: C
18. Room temperature is about 20 degrees on the:
- A. Kelvin scale
 - B. Celsius scale
 - C. Fahrenheit scale
 - D. absolute scale
 - E. C major scale
- ans: B
19. A thermometer indicates 98.6°C . It may be:
- A. outdoors on a cold day
 - B. in a comfortable room
 - C. in a cup of hot tea
 - D. in a normal person's mouth
 - E. in liquid air
- ans: C

20. The air temperature on a summer day might be about:
- A. 0°C
 - B. 10°C
 - C. 25°C
 - D. 80°C
 - E. 125°C
- ans: C
21. The two metallic strips that constitute some thermostats must differ in:
- A. length
 - B. thickness
 - C. mass
 - D. rate at which they conduct heat
 - E. coefficient of linear expansion
- ans: E
22. Thin strips of iron and zinc are riveted together to form a bimetallic strip that bends when heated. The iron is on the inside of the bend because:
- A. it has a higher coefficient of linear expansion
 - B. it has a lower coefficient of linear expansion
 - C. it has a higher specific heat
 - D. it has a lower specific heat
 - E. it conducts heat better
- ans: B
23. It is more difficult to measure the coefficient of volume expansion of a liquid than that of a solid because:
- A. no relation exists between linear and volume expansion coefficients
 - B. a liquid tends to evaporate
 - C. a liquid expands too much when heated
 - D. a liquid expands too little when heated
 - E. the containing vessel also expands
- ans: E
24. A surveyor's 30-m steel tape is correct at 68°F . On a hot day the tape has expanded to 30.01 m. On that day, the tape indicates a distance of 15.52 m between two points. The true distance between these points is:
- A. 15.50 m
 - B. 15.51 m
 - C. 15.52 m
 - D. 15.53 m
 - E. 15.54 m
- ans: B

25. The figure shows a rectangular brass plate at 0°C in which there is cut a rectangular hole of dimensions indicated. If the temperature of the plate is raised to 150°C :

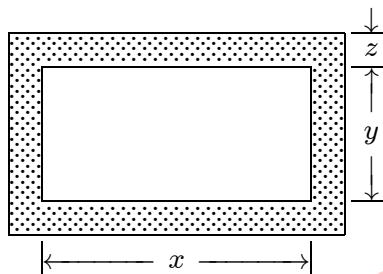

- A. x will increase and y will decrease
 B. both x and y will decrease
 C. x will decrease and y will increase
 D. both x and y will increase
 E. the changes in x and y depend on the dimension z
- ans: D
26. The Stanford linear accelerator contains hundreds of brass disks tightly fitted into a steel tube (see figure). The coefficient of linear expansion of the brass is 2.00×10^{-5} per $^\circ\text{C}$. The system was assembled by cooling the disks in dry ice (-57°C) to enable them to just slide into the close-fitting tube. If the diameter of a disk is 80.00 mm at 43°C , what is its diameter in the dry ice?

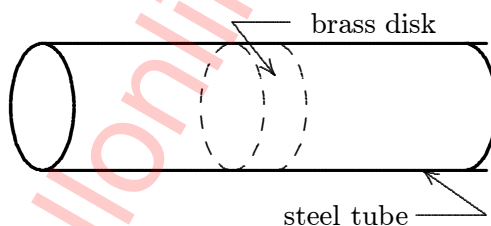

- A. 78.40 mm
 B. 79.68 mm
 C. 80.16 mm
 D. 79.84 mm
 E. None of these
- ans: D
27. When the temperature of a copper penny is increased by 100°C , its diameter increases by 0.17% . The area of one of its faces increases by:
- A. 0.17%
 B. 0.34%
 C. 0.51%
 D. 0.13%
 E. 0.27%
- ans: B

28. An annular ring of aluminum is cut from an aluminum sheet as shown. When this ring is heated:

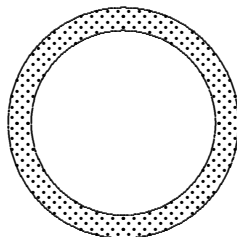

- A. the aluminum expands outward and the hole remains the same in size
B. the hole decreases in diameter
C. the area of the hole expands the same percent as any area of the aluminum
D. the area of the hole expands a greater percent than any area of the aluminum
E. linear expansion forces the shape of the hole to be slightly elliptical
ans: C
29. Possible units for the coefficient of volume expansion are:
A. mm/C°
B. $\text{mm}^3/\text{C}^\circ$
C. $(\text{C}^\circ)^3$
D. $1/(\text{C}^\circ)^3$
E. $1/\text{C}^\circ$
ans: E
30. The mercury column in an ordinary medical thermometer doubles in length when its temperature changes from 95°F to 105°F . Choose the correct statement:
A. the coefficient of volume expansion of mercury is 0.1 per F°
B. the coefficient of volume expansion of mercury is 0.3 per F°
C. the coefficient of volume expansion of mercury is $(0.1/3)$ per F°
D. the vacuum above the column helps to “pull up” the mercury this large amount
E. none of the above is true
ans: E
31. The coefficient of linear expansion of iron is 1.0×10^{-5} per C° . The surface area of an iron cube, with an edge length of 5.0 cm, will increase by what amount if it is heated from 10°C to 60°C ?
A. 0.0125 cm^2
B. 0.025 cm^2
C. 0.075 cm^2
D. 0.15 cm^2
E. 0.30 cm^2
ans: D

32. The diagram shows four rectangular plates and their dimensions. All are made of the same material. The temperature now increases. Of these plates:

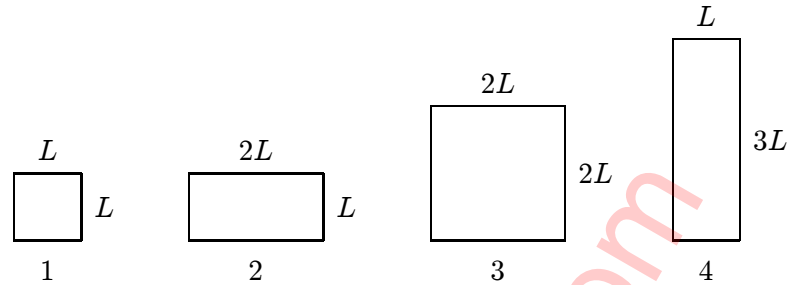

- A. the vertical dimension of plate 1 increases the most and the area of plate 1 increases the most
 B. the vertical dimension of plate 2 increases the most and the area of plate 4 increases the most
 C. the vertical dimension of plate 3 increases the most and the area of plate 1 increases the most
 D. the vertical dimension of plate 4 increases the most and the area of plate 3 increases the most
 E. the vertical dimension of plate 4 increases the most and the area of plate 4 increases the most
 ans: D
33. The coefficient of linear expansion of steel is 11×10^{-6} per $^{\circ}\text{C}$. A steel ball has a volume of exactly 100 cm^3 at 0°C . When heated to 100°C , its volume becomes:
 A. 100.33 cm^3
 B. 100.0011 cm^3
 C. 100.0033 cm^3
 D. 100.000011 cm^3
 E. none of these
 ans: A
34. The coefficient of linear expansion of a certain steel is 0.000012 per $^{\circ}\text{C}$. The coefficient of volume expansion, in $(^{\circ}\text{C})^{-1}$, is:
 A. $(0.000012)^3$
 B. $(4\pi/3)(0.000012)^3$
 C. 3×0.000012
 D. 0.000012
 E. depends on the shape of the volume to which it will be applied
 ans: C
35. Metal pipes, used to carry water, sometimes burst in the winter because:
 A. metal contracts more than water
 B. outside of the pipe contracts more than the inside
 C. metal becomes brittle when cold
 D. ice expands when it melts
 E. water expands when it freezes
 ans: E

36. A gram of distilled water at 4°C :
- A. will increase slightly in weight when heated to 6°C
 - B. will decrease slightly in weight when heated to 6°C
 - C. will increase slightly in volume when heated to 6°C
 - D. will decrease slightly in volume when heated to 6°C
 - E. will not change in either volume or weight
- ans: D
37. Heat is:
- A. energy transferred by virtue of a temperature difference
 - B. energy transferred by macroscopic work
 - C. energy content of an object
 - D. a temperature difference
 - E. a property objects have by virtue of their temperatures
- ans: A
38. Heat has the same units as:
- A. temperature
 - B. work
 - C. energy/time
 - D. heat capacity
 - E. energy/volume
- ans: B
39. A calorie is about:
- A. 0.24 J
 - B. 8.3 J
 - C. 250 J
 - D. 4.2 J
 - E. 4200 J
- ans: D
40. The heat capacity of an object is:
- A. the amount of heat energy that raises its temperature by 1°C
 - B. the amount of heat energy that changes its state without changing its temperature
 - C. the amount of heat energy per kilogram that raises its temperature by 1°C
 - D. the ratio of its specific heat to that of water
 - E. the change in its temperature caused by adding 1 J of heat
- ans: A

41. The specific heat of a substance is:
- A. the amount of heat energy to change the state of one gram of the substance
 - B. the amount of heat energy per unit mass emitted by oxidizing the substance
 - C. the amount of heat energy per unit mass to raise the substance from its freezing to its boiling point
 - D. the amount of heat energy per unit mass to raise the temperature of the substance by 1°C
 - E. the temperature of the object divided by its mass
- ans: D
42. Two different samples have the same mass and temperature. Equal quantities of energy are absorbed as heat by each. Their final temperatures may be different because the samples have different:
- A. thermal conductivities
 - B. coefficients of expansion
 - C. densities
 - D. volumes
 - E. heat capacities
- ans: E
43. The same energy Q enters five different substances as heat.
- The temperature of 3 g of substance A increases by 10 K
 - The temperature of 4 g of substance B increases by 4 K
 - The temperature of 6 g of substance C increases by 15 K
 - The temperature of 8 g of substance D increases by 6 K
 - The temperature of 10 g of substance E increases by 10 K
- Which substance has the greatest specific heat?
- ans: B
44. For constant-volume processes the heat capacity of gas A is greater than the heat capacity of gas B. We conclude that when they both absorb the same energy as heat at constant volume:
- A. the temperature of A increases more than the temperature of B
 - B. the temperature of B increases more than the temperature of A
 - C. the internal energy of A increases more than the internal energy of B
 - D. the internal energy of B increases more than the internal energy of A
 - E. A does more positive work than B
- ans: B
45. The heat capacity at constant volume and the heat capacity at constant pressure have different values because:
- A. heat increases the temperature at constant volume but not at constant pressure
 - B. heat increases the temperature at constant pressure but not at constant volume
 - C. the system does work at constant volume but not at constant pressure
 - D. the system does work at constant pressure but not at constant volume
 - E. the system does more work at constant volume than at constant pressure
- ans: D

46. A cube of aluminum has an edge length of 20 cm. Aluminum has a density 2.7 times that of water (1 g/cm^3) and a specific heat 0.217 times that of water ($1 \text{ cal/g} \cdot \text{C}^\circ$). When the internal energy of the cube increases by 47000 cal its temperature increases by:
- A. 5 C°
 - B. 10 C°
 - C. 20 C°
 - D. 100 C°
 - E. 200 C°
- ans: B
47. An insulated container, filled with water, contains a thermometer and a paddle wheel. The paddle wheel can be rotated by an external source. This apparatus can be used to determine:
- A. specific heat of water
 - B. relation between kinetic energy and absolute temperature
 - C. thermal conductivity of water
 - D. efficiency of changing work into heat
 - E. mechanical equivalent of heat
- ans: E
48. Take the mechanical equivalent of heat as 4 J/cal . A 10-g bullet moving at 2000 m/s plunges into 1 kg of paraffin wax (specific heat $0.7 \text{ cal/g} \cdot \text{C}^\circ$). The wax was initially at 20° C . Assuming that all the bullet's energy heats the wax, its final temperature (in $^\circ \text{ C}$) is:
- A. 20.14
 - B. 23.5
 - C. 20.006
 - D. 27.1
 - E. 30.23
- ans: D
49. The energy given off as heat by 300 g of an alloy as it cools through 50 C° raises the temperature of 300 g of water from 30° C to 40° C . The specific heat of the alloy (in $\text{cal/g} \cdot \text{C}^\circ$) is:
- A. 0.015
 - B. 0.10
 - C. 0.15
 - D. 0.20
 - E. 0.50
- ans: D
50. The specific heat of lead is $0.030 \text{ cal/g} \cdot \text{C}^\circ$. 300 g of lead shot at 100° C is mixed with 100 g of water at 70° C in an insulated container. The final temperature of the mixture is:
- A. 100° C
 - B. 85.5° C
 - C. 79.5° C
 - D. 74.5° C
 - E. 72.5° C
- ans: E

51. Object A, with heat capacity C_A and initially at temperature T_A , is placed in thermal contact with object B, with heat capacity C_B and initially at temperature T_B . The combination is thermally isolated. If the heat capacities are independent of the temperature and no phase changes occur, the final temperature of both objects is:

- A. $(C_A T_A - C_B T_B)/(C_A + C_B)$
- B. $(C_A T_A + C_B T_B)/(C_A + C_B)$
- C. $(C_A T_A - C_B T_B)/(C_A - C_B)$
- D. $(C_A - C_B)|T_A - T_B|$
- E. $(C_A + C_B)|T_A - T_B|$

ans: B

52. The heat capacity of object B is twice that of object A. Initially A is at 300 K and B is at 450 K. They are placed in thermal contact and the combination is isolated. The final temperature of both objects is:

- A. 200 K
- B. 300 K
- C. 400 K
- D. 450 K
- E. 600 K

ans: C

53. A heat of transformation of a substance is:

- A. the energy absorbed as heat during a phase transformation
- B. the energy per unit mass absorbed as heat during a phase transformation
- C. the same as the heat capacity
- D. the same as the specific heat
- E. the same as the molar specific heat

ans: B

54. The heat of fusion of water is cal/g. This means 80 cal of energy are required to:

- A. raise the temperature of 1 g of water by 1 K
- B. turn 1 g of water to steam
- C. raise the temperature of 1 g of ice by 1 K
- D. melt 1 g of ice
- E. increase the internal energy of 80 g of water by 1 cal

ans: D

55. Solid A, with mass M , is at its melting point T_A . It is placed in thermal contact with solid B, with heat capacity C_B and initially at temperature T_B ($T_B > T_A$). The combination is thermally isolated. A has latent heat of fusion L and when it has melted has heat capacity C_A . If A completely melts the final temperature of both A and B is:

- A. $(C_A T_A + C_B T_B - ML)/(C_A + C_B)$
- B. $(C_A T_A - C_B T_B + ML)/(C_A + C_B)$
- C. $(C_A T_A - C_B T_B - ML)/(C_A + C_B)$
- D. $(C_A T_A + C_B T_B + ML)/(C_A - C_B)$
- E. $(C_A T_A + C_B T_B + ML)/(C_A - C_B)$

ans: A

56. During the time that latent heat is involved in a change of state:
- A. the temperature does not change
 - B. the substance always expands
 - C. a chemical reaction takes place
 - D. molecular activity remains constant
 - E. kinetic energy changes into potential energy
- ans: A
57. The formation of ice from water is accompanied by:
- A. absorption of energy as heat
 - B. temperature increase
 - C. decrease in volume
 - D. an evolution of heat
 - E. temperature decrease
- ans: A
58. How many calories are required to change one gram of 0°C ice to 100°C steam? The latent heat of fusion is 80 cal/g and the latent heat of vaporization is 540 cal/g . The specific heat of water is $1.00\text{ cal/g}\cdot\text{K}$.
- A. 100
 - B. 540
 - C. 620
 - D. 720
 - E. 900
- ans: D
59. Ten grams of ice at -20°C is to be changed to steam at 130°C . The specific heat of both ice and steam is $0.5\text{ cal/g}\cdot\text{C}^{\circ}$. The heat of fusion is 80 cal/g and the heat of vaporization is 540 cal/g . The entire process requires:
- A. 750 cal
 - B. 1250 cal
 - C. 6950 cal
 - D. 7450 cal
 - E. 7700 cal
- ans: D
60. Steam at 1 atm and 100°C enters a radiator and leaves as water at 1 atm and 80°C . Take the heat of vaporization to be 540 cal/g . Of the total energy given off as heat, what percent arises from the cooling of the water?
- A. 100
 - B. 54
 - C. 26
 - D. 14
 - E. 3.6
- ans: E

61. A certain humidifier operates by raising water to the boiling point and then evaporating it. Every minute 30 g of water at 20° C are added to replace the 30 g that are evaporated. The heat of fusion of water is 333 kJ/kg, the heat of vaporization is 2256 kJ/kg, and the specific heat is 4190 J/kg · K. How many joules of energy per minute does this humidifier require?
- A. 3.0×10^4
 - B. 8.8×10^4
 - C. 7.8×10^4
 - D. 1.1×10^5
 - E. 2.0×10^4
- ans: B
62. A metal sample of mass M requires a power input P to just remain molten. When the heater is turned off, the metal solidifies in a time T . The specific latent heat of fusion of this metal is:
- A. P/MT
 - B. T/PM
 - C. PM/T
 - D. PMT
 - E. PT/M
- ans: E
63. Fifty grams of ice at 0° C is placed in a thermos bottle containing one hundred grams of water at 6° C. How many grams of ice will melt? The heat of fusion of water is 333 kJ/kg and the specific heat is 4190 J/kg · K.
- A. 7.5
 - B. 2.0
 - C. 8.3
 - D. 17
 - E. 50
- ans: A
64. According to the first law of thermodynamics, applied to a gas, the increase in the internal energy during any process:
- A. equals the heat input minus the work done on the gas
 - B. equals the heat input plus the work done on the gas
 - C. equals the work done on the gas minus the heat input
 - D. is independent of the heat input
 - E. is independent of the work done on the gas
- ans: B

65. Pressure versus volume graphs for a certain gas undergoing five different cyclic processes are shown below. During which cycle does the gas do the greatest positive work?

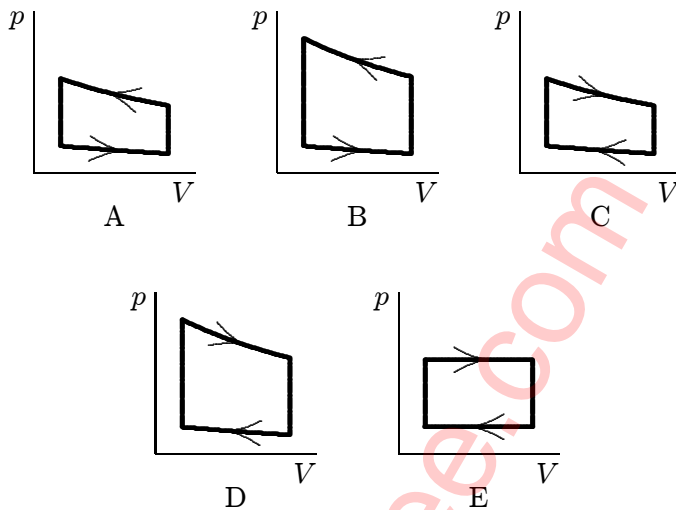

ans: D

66. During an adiabatic process an object does 100 J of work and its temperature decreases by 5 K. During another process it does 25 J of work and its temperature decreases by 5 K. Its heat capacity for the second process is:

- A. 20 J/K
- B. 24 J/K
- C. 5 J/K
- D. 15 J/K
- E. 100 J/K

ans: D

67. A system undergoes an adiabatic process in which its internal energy increases by 20 J. Which of the following statements is true?

- A. 20 J of work was done on the system
- B. 20 J of work was done by the system
- C. the system received 20 J of energy as heat
- D. the system lost 20 J of energy as heat
- E. none of the above are true

ans: A

68. In an adiabatic process:

- A. the energy absorbed as heat equals the work done by the system on its environment
- B. the energy absorbed as heat equals the work done by the environment on the system
- C. the absorbed as heat equals the change in internal energy
- D. the work done by the environment on the system equals the change in internal energy
- E. the work done by the system on its environment equals to the change in internal energy

ans: D

69. In a certain process a gas ends in its original thermodynamic state. Of the following, which is possible as the net result of the process?
- A. It is adiabatic and the gas does 50 J of work
 - B. The gas does no work but absorbs 50 J of energy as heat
 - C. The gas does no work but loses 50 J of energy as heat
 - D. The gas loses 50 J of energy as heat and does 50 J of work
 - E. The gas absorbs 50 J of energy as heat and does 50 J of work
- ans: E
70. Of the following which might NOT vanish over one cycle of a cyclic process?
- A. the change in the internal energy of the substance
 - B. the change in pressure of the substance
 - C. the work done by the substance
 - D. the change in the volume of the substance
 - E. the change in the temperature of the substance
- ans: C
71. Of the following which might NOT vanish over one cycle of a cyclic process?
- A. the work done by the substance minus the energy absorbed by the substance as heat
 - B. the change in the pressure of the substance
 - C. the energy absorbed by the substance as heat
 - D. the change in the volume of the substance
 - E. the change in the temperature of the substance
- ans: C
72. The unit of thermal conductivity might be:
- A. $\text{cal} \cdot \text{cm}/(\text{s} \cdot \text{C}^\circ)$
 - B. $\text{cal}/(\text{cm} \cdot \text{s} \cdot \text{C}^\circ)$
 - C. $\text{cal} \cdot \text{s}/(\text{cm} \cdot \text{C}^\circ)$
 - D. $\text{cm} \cdot \text{s} \cdot \text{C}^\circ/\text{cal}$
 - E. $\text{C}^\circ/(\text{cal} \cdot \text{cm} \cdot \text{s})$
- ans: B
73. A slab of material has area A , thickness L , and thermal conductivity k . One of its surfaces (P) is maintained at temperature T_1 and the other surface (Q) is maintained at a lower temperature T_2 . The rate of heat flow by conduction from P to Q is:
- A. $kA(T_1 - T_2)/L^2$
 - B. $kL(T_1 - T_2)/A$
 - C. $kA(T_1 - T_2)/L$
 - D. $k(T_1 - T_2)/(LA)$
 - E. $LA(T_1 - T_2)/k$
- ans: C

74. The rate of heat flow by conduction through a slab does NOT depend upon the:
- temperature difference between opposite faces of the slab
 - thermal conductivity of the slab
 - slab thickness
 - cross-sectional area of the slab
 - specific heat of the slab
- ans: E
75. The rate of heat flow by conduction through a slab is P_{cond} . If the slab thickness is doubled, its cross-sectional area is halved, and the temperature difference across it is doubled, then the rate of heat flow becomes:
- $2P_{\text{cond}}$
 - $P_{\text{cond}}/2$
 - P_{cond}
 - $P_{\text{cond}}/8$
 - $8P_{\text{cond}}$
- ans: B

76. The diagram shows four slabs of different materials with equal thickness, placed side by side. Heat flows from left to right and the steady-state temperatures of the interfaces are given. Rank the materials according to their thermal conductivities, smallest to largest.

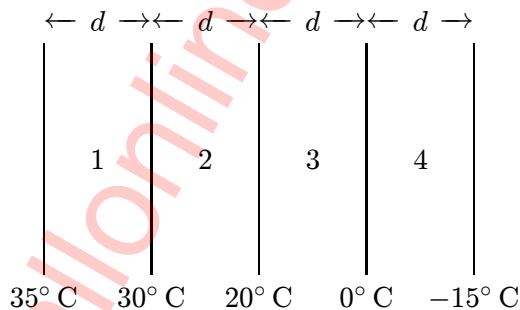

- 1, 2, 3, 4
 - 2, 1, 3, 4
 - 3, 4, 1, 2
 - 3, 4, 2, 1
 - 4, 3, 2, 1
- ans: D
77. Inside a room at a uniform comfortable temperature, metallic objects generally feel cooler to the touch than wooden objects do. This is because:
- a given mass of wood contains more heat than the same mass of metal
 - metal conducts heat better than wood
 - heat tends to flow from metal to wood
 - the equilibrium temperature of metal in the room is lower than that of wood
 - the human body, being organic, resembles wood more closely than it resembles metal
- ans: B

78. On a very cold day, a child puts his tongue against a fence post. It is much more likely that his tongue will stick to a steel post than to a wooden post. This is because:
- A. steel has a higher specific heat
 - B. steel is a better radiator of heat
 - C. steel has a higher specific gravity
 - D. steel is a better heat conductor
 - E. steel is a highly magnetic material
- ans: D
79. An iron stove, used for heating a room by radiation, is more efficient if:
- A. its inner surface is highly polished
 - B. its inner surface is covered with aluminum paint
 - C. its outer surface is covered with aluminum paint
 - D. its outer surface is rough and black
 - E. its outer surface is highly polished
- ans: D
80. To help keep buildings cool in the summer, dark colored window shades have been replaced by light colored shades. This is because light colored shades:
- A. are more pleasing to the eye
 - B. absorb more sunlight
 - C. reflect more sunlight
 - D. transmit more sunlight
 - E. have a lower thermal conductivity
- ans: C
81. Which of the following statements pertaining to a vacuum flask (thermos) is NOT correct?
- A. Silvering reduces radiation loss
 - B. Vacuum reduces conduction loss
 - C. Vacuum reduces convection loss
 - D. Vacuum reduces radiation loss
 - E. Glass walls reduce conduction loss
- ans: D
82. A thermos bottle works well because:
- A. its glass walls are thin
 - B. silvering reduces convection
 - C. vacuum reduces heat radiation
 - D. silver coating is a poor heat conductor
 - E. none of the above
- ans: E

Chapter 19: THE KINETIC THEORY OF GASES

- Evidence that a gas consists mostly of empty space is the fact that:
 - the density of a gas becomes much greater when it is liquefied
 - gases exert pressure on the walls of their containers
 - gases are transparent
 - heating a gas increases the molecular motion
 - nature abhors a vacuumans: A
- Air enters a hot-air furnace at 7°C and leaves at 77°C . If the pressure does not change each entering cubic meter of air expands to:
 - 0.80 m^3
 - 1.25 m^3
 - 1.9 m^3
 - 7.0 m^3
 - 11 m^3ans: B
- 273 cm^3 of an ideal gas is at 0°C . It is heated at constant pressure to 10°C . It will now occupy:
 - 263 cm^3
 - 273 cm^3
 - 283 cm^3
 - 278 cm^3
 - 293 cm^3ans: C
- Two identical rooms in a house are connected by an open doorway. The temperatures in the two rooms are maintained at different values. Which room contains more air?
 - the room with higher temperature
 - the room with lower temperature
 - the room with higher pressure
 - neither because both have the same pressure
 - neither because both have the same volumeans: B
- It is known that 28 g of a certain ideal gas occupy 22.4 liters at standard conditions (0°C , 1 atm). The volume occupied by 42 g of this gas at standard conditions is:
 - 14.9 liters
 - 22.4 liters
 - 33.6 liters
 - 42 liters
 - more data are neededans: C

6. An automobile tire is pumped up to a gauge pressure of 2.0×10^5 Pa when the temperature is 27°C . What is its gauge pressure after the car has been running on a hot day so that the tire temperature is 77°C ? Assume that the volume remains fixed and take atmospheric pressure to be 1.013×10^5 Pa.
- A. 1.6×10^5 Pa
 - B. 2.6×10^5 Pa
 - C. 3.6×10^5 Pa
 - D. 5.9×10^5 Pa
 - E. 7.9×10^5 Pa

ans: A

7. A sample of an ideal gas is compressed by a piston from 10 m^3 to 5 m^3 and simultaneously cooled from 273°C to 0°C . As a result there is:
- A. an increase in pressure
 - B. a decrease in pressure
 - C. a decrease in density
 - D. no change in density
 - E. an increase in density

ans: E

8. A 2-m^3 weather balloon is loosely filled with helium at 1 atm (76 cm Hg) and at 27°C . At an elevation of 20,000 ft, the atmospheric pressure is down to 38 cm Hg and the helium has expanded, being under no constraint from the confining bag. If the temperature at this elevation is -48°C , the gas volume (in m^3) is:
- A. 3
 - B. 4
 - C. 2
 - D. 2.5
 - E. 5.3

ans: A

9. Oxygen (molar mass = 32 g) occupies a volume of 12 liters when its temperature is 20°C and its pressure is 1 atm. Using $R = 0.082$ liter \cdot atm/mol \cdot K, calculate the mass of the oxygen:
- A. 6.4 g
 - B. 10. g
 - C. 16 g
 - D. 32 g
 - E. 64 g

ans: C

10. An ideal gas occupies 12 liters at 293 K and 1 atm (76 cm Hg). Its temperature is now raised to 373 K and its pressure increased to 215 cm Hg. The new volume is:
- A. 0.2 liters
 - B. 5.4 liters
 - C. 13.6 liters
 - D. 20.8 liters
 - E. none of these

ans: B

11. Use $R = 8.2 \times 10^{-5} \text{ m}^3 \cdot \text{atm/mol} \cdot \text{K}$ and $N_A = 6.02 \times 10^{23} \text{ mol}^{-1}$. The approximate number of air molecules in a 1 m^3 volume at room temperature (300 K and atmospheric pressure is:
- A. 41
 - B. 450
 - C. 2.5×10^{25}
 - D. 2.7×10^{26}
 - E. 5.4×10^{26}
- ans: C
12. An air bubble doubles in volume as it rises from the bottom of a lake (1000 kg/m^3). Ignoring any temperature changes, the depth of the lake is:
- A. 21 m
 - B. 0.76 m
 - C. 4.9 m
 - D. 10 m
 - E. 0.99 m
- ans: D
13. An isothermal process for an ideal gas is represented on a p - V diagram by:
- A. a horizontal line
 - B. a vertical line
 - C. a portion of an ellipse
 - D. a portion of a parabola
 - E. a portion of a hyperbola
- ans: E
14. An ideal gas undergoes an isothermal process starting with a pressure of $2 \times 10^5 \text{ Pa}$ and a volume of 6 cm^3 . Which of the following might be the pressure and volume of the final state?
- A. $1 \times 10^5 \text{ Pa}$ and 10 cm^3
 - B. $3 \times 10^5 \text{ Pa}$ and 6 cm^3
 - C. $4 \times 10^5 \text{ Pa}$ and 4 cm^3
 - D. $6 \times 10^5 \text{ Pa}$ and 2 cm^3
 - E. $8 \times 10^5 \text{ Pa}$ and 2 cm^3
- ans: D
15. The pressures p and volumes V of five ideal gases, with the same number of molecules, are given below. Which has the highest temperature?
- A. $p = 1 \times 10^5 \text{ Pa}$ and $V = 10 \text{ cm}^3$
 - B. $p = 3 \times 10^5 \text{ Pa}$ and $V = 6 \text{ cm}^3$
 - C. $p = 4 \times 10^5 \text{ Pa}$ and $V = 4 \text{ cm}^3$
 - D. $p = 6 \times 10^5 \text{ Pa}$ and $V = 2 \text{ cm}^3$
 - E. $p = 8 \times 10^5 \text{ Pa}$ and $V = 2 \text{ cm}^3$
- ans: B

16. During a slow adiabatic expansion of a gas:
- A. the pressure remains constant
 - B. energy is added as heat
 - C. work is done on the gas
 - D. no energy enters or leaves as heat
 - E. the temperature is constant
- ans: D
17. An adiabatic process for an ideal gas is represented on a p - V diagram by:
- A. a horizontal line
 - B. a vertical line
 - C. a hyperbola
 - D. a circle
 - E. none of these
- ans: E
18. A real gas undergoes a process that can be represented as a curve on a p - V diagram. The work done by the gas during this process is:
- A. pV
 - B. $p(V_2 - V_1)$
 - C. $(p_2 - p_1)V$
 - D. $\int p dV$
 - E. $V dp$
- ans: D
19. A real gas is changed slowly from state 1 to state 2. During this process no work is done on or by the gas. This process must be:
- A. isothermal
 - B. adiabatic
 - C. isovolumic
 - D. isobaric
 - E. a closed cycle with state 1 coinciding with state 2
- ans: C
20. A given mass of gas is enclosed in a suitable container so that it may be maintained at constant volume. Under these conditions, there can be no change in what property of the gas?
- A. Pressure
 - B. Density
 - C. Molecular kinetic energy
 - D. Internal energy
 - E. Temperature
- ans: B

21. A quantity of an ideal gas is compressed to half its initial volume. The process may be adiabatic, isothermal, or isobaric. Rank those three processes in order of the work required of an external agent, least to greatest.
- A. adiabatic, isothermal, isobaric
 - B. adiabatic, isobaric, isothermal
 - C. isothermal, adiabatic, isobaric
 - D. isobaric, adiabatic, isothermal
 - E. isobaric, isothermal, adiabatic
- ans: E
22. During a reversible adiabatic expansion of an ideal gas, which of the following is NOT true?
- A. $pV^\gamma = \text{constant}$
 - B. $pV = nRT$
 - C. $TV^{\gamma-1} = \text{constant}$
 - D. $|W| = \int p dV$
 - E. $pV = \text{constant}$
- ans: E
23. In order that a single process be both isothermal and isobaric:
- A. one must use an ideal gas
 - B. such a process is impossible
 - C. a change of phase is essential
 - D. one may use any real gas such as N_2
 - E. one must use a solid
- ans: C
24. Over 1 cycle of a cyclic process in which a system does net work on its environment:
- A. the change in the pressure of the system cannot be zero
 - B. the change in the volume of the system cannot be zero
 - C. the change in the temperature of the system cannot be zero
 - D. the change in the internal energy of the system cannot be zero
 - E. none of the above
- ans: E
25. Evidence that molecules of a gas are in constant motion is:
- A. winds exert pressure
 - B. two gases interdiffuse quickly
 - C. warm air rises
 - D. energy as heat is needed to vaporize a liquid
 - E. gases are easily compressed
- ans: B

26. According to the kinetic theory of gases, the pressure of a gas is due to:
- A. change of kinetic energy of molecules as they strike the wall
 - B. change of momentum of molecules as they strike the wall
 - C. average kinetic energy of the molecules
 - D. force of repulsion between the molecules
 - E. rms speed of the molecules
- ans: B
27. The force on the walls of a vessel of a contained gas is due to:
- A. the repulsive force between gas molecules
 - B. a slight loss in the speed of a gas molecule during a collision with the wall
 - C. a change in momentum of a gas molecule during a collision with the wall
 - D. elastic collisions between gas molecules
 - E. inelastic collisions between gas molecules
- ans: C
28. A gas is confined to a cylindrical container of radius 1 cm and length 1 m. The pressure exerted on an end face, compared with the pressure exerted on the long curved face, is:
- A. smaller because its area is smaller
 - B. smaller because most molecules cannot traverse the length of the cylinder without undergoing collisions
 - C. larger because the face is flat
 - D. larger because the molecules have a greater distance in which to accelerate before they strike the face
 - E. none of these
- ans: E
29. Air is pumped into a bicycle tire at constant temperature. The pressure increases because:
- A. more molecules strike the tire wall per second
 - B. the molecules are larger
 - C. the molecules are farther apart
 - D. each molecule is moving faster
 - E. each molecule has more kinetic energy
- ans: A
30. The temperature of a gas is most closely related to:
- A. the kinetic energy of translation of its molecules
 - B. its total molecular kinetic energy
 - C. the sizes of its molecules
 - D. the potential energy of its molecules
 - E. the total energy of its molecules
- ans: A

31. The temperature of low pressure hydrogen is reduced from 100°C to 20°C . The rms speed of its molecules decreases by approximately:
- A. 80%
 - B. 89%
 - C. 46%
 - D. 21%
 - E. 11%
- ans: E
32. The mass of an oxygen molecule is 16 times that of a hydrogen molecule. At room temperature, the ratio of the rms speed of an oxygen molecule to that of a hydrogen molecule is:
- A. 16
 - B. 4
 - C. 1
 - D. $1/4$
 - E. $1/16$
- ans: D
33. The rms speed of an oxygen molecule at 0°C is 460 m/s . If the molar mass of oxygen is 32 g and that of helium is 4 g , then the rms speed of a helium molecule at 0°C is:
- A. 230 m/s
 - B. 326 m/s
 - C. 650 m/s
 - D. 920 m/s
 - E. 1300 m/s
- ans: E
34. A sample of argon gas (molar mass 40 g) is at four times the absolute temperature of a sample of hydrogen gas (molar mass 2 g). The ratio of the rms speed of the argon molecules to that of the hydrogen is:
- A. 1
 - B. 5
 - C. $1/5$
 - D. $\sqrt{5}$
 - E. $1/\sqrt{5}$
- ans: D
35. If the molecules in a tank of hydrogen have the same rms speed as the molecules in a tank of oxygen, we may be sure that:
- A. the pressures are the same
 - B. the hydrogen is at the higher temperature
 - C. the hydrogen is at the greater pressure
 - D. the temperatures are the same
 - E. the oxygen is at the higher temperature
- ans: E

36. The principle of equipartition of energy states that the internal energy of a gas is shared equally:
- A. among the molecules
 - B. between kinetic and potential energy
 - C. among the relevant degrees of freedom
 - D. between translational and vibrational kinetic energy
 - E. between temperature and pressure
- ans: C
37. The number of degrees of freedom of a rigid diatomic molecule is:
- A. 2
 - B. 3
 - C. 4
 - D. 5
 - E. 6
- ans: D
38. The number of degrees of freedom of a triatomic molecule is:
- A. 1
 - B. 3
 - C. 6
 - D. 8
 - E. 9
- ans: E
39. Five molecules have speeds of 2.8, 3.2, 5.8, 7.3, and 7.4 m/s. Their root-mean-square speed is closest to:
- A. 5.3 m/s
 - B. 5.7 m/s
 - C. 7.3 m/s
 - D. 28 m/s
 - E. 32 m/s
- ans: B
40. The speeds of 25 molecules are distributed as follows: 5 in the range from 2 to 3 m/s, 10 in the range from 3 to 4 m/s, 5 in the range from 4 to 5 m/s, 3 in the range from 5 to 6 m/s, 1 in the range from 6 to 7 m/s, and 1 in the range from 7 to 8 m/s. Their average speed is about:
- A. 2 m/s
 - B. 3 m/s
 - C. 4 m/s
 - D. 5 m/s
 - E. 6 m/s
- ans: C

41. In a system of N gas molecules, the individual speeds are v_1, v_2, \dots, v_N . The rms speed of these molecules is:

A. $\frac{1}{N} \sqrt{v_1 + v_2 + \dots + v_N}$

B. $\frac{1}{N} \sqrt{v_1^2 + v_2^2 + \dots + v_N^2}$

C. $\sqrt{(v_1^2 + v_2^2 + \dots + v_N^2)/N}$

D. $\sqrt{[(v_1 + v_2 + \dots + v_N)/N]^2}$

E. $\sqrt{(v_1 + v_2 + \dots + v_N)^2/N}$

ans: C

42. A system consists of N gas molecules, each with mass m . Their rms speed is v_{rms} . Their total translational kinetic energy is:

A. $(1/2)m(Nv_{\text{rms}})^2$

B. $(1/2)N(mv_{\text{rms}})^2$

C. $(1/2)mv_{\text{rms}}^2$

D. $(1/2)Nmv_{\text{rms}}^2$

E. $N[(1/2)mv_{\text{rms}}]^2$

ans: D

43. The average speeds v and molecular diameters d of five ideal gases are given below. The number of molecules per unit volume is the same for all of them. For which is the collision rate the greatest?

A. $v = v_0$ and $d = d_0$

B. $v = 2v_0$ and $d = d_0/2$

C. $v = 3v_0$ and $d = d_0$

D. $v = v_0$ and $d = 2d_0$

E. $v = 4v_0$ and $d = d_0/2$

ans: D

44. The internal energy of an ideal gas depends on:

A. the temperature only

B. the pressure only

C. the volume only

D. the temperature and pressure only

E. temperature, pressure, and volume

ans: A

45. The diagram shows three isotherms for an ideal gas, with $T_3 - T_2$ the same as $T_2 - T_1$. It also shows five thermodynamic processes carried out on the gas. Rank the processes in order of the change in the internal energy of the gas, least to greatest.

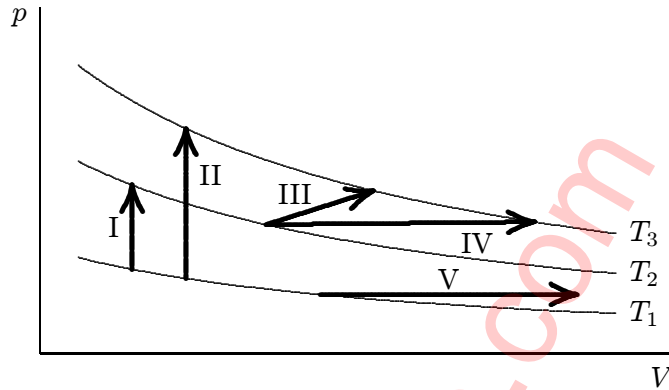

- A. I, II, III, IV, V
 B. V, then I, III, and IV tied, then II
 C. V, I, then III and IV tied, then II
 D. IV, V, III, I, II
 E. II, I, then III, IV, and V tied
- ans: B
46. An ideal gas of N monatomic molecules is in thermal equilibrium with an ideal gas of the same number of diatomic molecules and equilibrium is maintained as the temperature is increased. The ratio of the changes in the internal energies $\Delta E_{\text{dia}}/\Delta E_{\text{mon}}$ is:
- A. $1/2$
 B. $3/5$
 C. 1
 D. $5/3$
 E. 2
- ans: D
47. Two ideal gases, each consisting of N monatomic molecules, are in thermal equilibrium with each other and equilibrium is maintained as the temperature is increased. A molecule of the first gas has mass m and a molecule of the second has mass $4m$. The ratio of the changes in the internal energies $\Delta E_{4m}/\Delta E_m$ is:
- A. $1/4$
 B. $1/2$
 C. 1
 D. 2
 E. 4
- ans: C

48. Three gases, one consisting of monatomic molecules, one consisting of diatomic molecules, and one consisting of polyatomic molecules, are in thermal equilibrium with each other and remain in thermal equilibrium as the temperature is raised. All have the same number of molecules. The gases with the least and greatest change in internal energy are respectively:
- A. polyatomic, monatomic
 - B. monatomic, polyatomic
 - C. diatomic, monatomic
 - D. polyatomic, diatomic
 - E. monatomic, diatomic
- ans: B
49. An ideal gas of N diatomic molecules has temperature T . If the number of molecules is doubled without changing the temperature, the internal energy increases by:
- A. 0
 - B. $(1/2)NkT$
 - C. $(3/2)NkT$
 - D. $(5/2)NkT$
 - E. $3NkT$
- ans: D
50. Both the pressure and volume of an ideal gas of diatomic molecules are doubled. The ratio of the new internal energy to the old, both measured relative to the internal energy at 0 K, is
- A. $1/4$
 - B. $1/2$
 - C. 1
 - D. 2
 - E. 4
- ans: E
51. The pressure of an ideal gas of diatomic molecules is doubled by halving the volume. The ratio of the new internal energy to the old, both measured relative to the internal energy at 0 K, is:
- A. $1/4$
 - B. $1/2$
 - C. 1
 - D. 2
 - E. 4
- ans: C
52. When work W is done on an ideal gas of N diatomic molecules in thermal isolation the temperature increases by:
- A. $W/2Nk$
 - B. $W/3Nk$
 - C. $2W/3Nk$
 - D. $2W/5Nk$
 - E. W/Nk
- ans: D

53. When work W is done on an ideal gas of diatomic molecules in thermal isolation the increase in the total rotational energy of the molecules is:
- A. 0
 - B. $W/3$
 - C. $2W/3$
 - D. $2W/5$
 - E. W
- ans: D
54. When work W is done on an ideal gas of diatomic molecules in thermal isolation the increase in the total translational kinetic energy of the molecules is:
- A. 0
 - B. $2W/3$
 - C. $2W/5$
 - D. $3W/5$
 - E. W
- ans: D
55. The pressure of an ideal gas is doubled in an isothermal process. The root-mean-square speed of the molecules:
- A. does not change
 - B. increases by a factor of $\sqrt{2}$
 - C. decreases by a factor of $1/\sqrt{2}$
 - D. increases by a factor of 2
 - E. decreases by a factor of 1/2
- ans: A
56. The Maxwellian speed distribution provides a direct explanation of:
- A. thermal expansion
 - B. the ideal gas law
 - C. heat
 - D. evaporation
 - E. boiling
- ans: D
57. For a gas at thermal equilibrium the average speed v , the most probable speed v_p , and the root-mean-square speed v_{rms} are in the order:
- A. $v_p < v_{\text{rms}} < v$
 - B. $v_{\text{rms}} < v_p < v$
 - C. $v < v_{\text{rms}} < v_p$
 - D. $v_p < v < v_{\text{rms}}$
 - E. $v < v_p < v_{\text{rms}}$
- ans: D

58. The average speed of air molecules at room temperature is about:
- A. zero
 - B. 2 m/s (walking speed)
 - C. 30 m/s (fast car)
 - D. 500 m/s (supersonic airplane)
 - E. 3×10^8 m/s (speed of light)
- ans: D
59. The root-mean-square speed of molecules in a gas is:
- A. the most probable speed
 - B. that speed such that half the molecules are moving faster than v_{rms} and the other half are moving slower
 - C. the average speed of the molecules
 - D. the square root of the square of the average speed
 - E. none of the above
- ans: E
60. According to the Maxwellian speed distribution, as the temperature increases the number of molecules with speeds within a small interval near the most probable speed:
- A. increases
 - B. decreases
 - C. increases at high temperatures and decreases at low
 - D. decreases at high temperatures and increases at low
 - E. stays the same
- ans: B
61. According to the Maxwellian speed distribution, as the temperature increases the most probable speed:
- A. increases
 - B. decreases
 - C. increases at high temperatures and decreases at low
 - D. decreases at high temperatures and increases at low
 - E. stays the same
- ans: A
62. According to the Maxwellian speed distribution, as the temperature increases the average speed:
- A. increases
 - B. decreases
 - C. increases at high temperatures and decreases at low
 - D. decreases at high temperatures and increases at low
 - E. stays the same
- ans: A

63. As the pressure in an ideal gas is increased isothermally the average molecular speed:
- A. increases
 - B. decreases
 - C. increases at high temperature, decreases at low
 - D. decreases at high temperature, increases at low
 - E. stays the same
- ans: E
64. As the volume of an ideal gas is increased at constant pressure the average molecular speed:
- A. increases
 - B. decreases
 - C. increases at high temperature, decreases at low
 - D. decreases at high temperature, increases at low
 - E. stays the same
- ans: A
65. Two ideal monatomic gases are in thermal equilibrium with each other. Gas A is composed of molecules with mass m while gas B is composed of molecules with mass $4m$. The ratio of the average molecular speeds v_A/v_B is:
- A. $1/4$
 - B. $1/2$
 - C. 1
 - D. 2
 - E. 4
- ans: D
66. Ideal monatomic gas A is composed of molecules with mass m while ideal monatomic gas B is composed of molecules with mass $4m$. The average molecular speeds are the same if the ratio of the temperatures T_A/T_B is:
- A. $1/4$
 - B. $1/2$
 - C. 1
 - D. 2
 - E. 4
- ans: A
67. Two monatomic ideal gases are in thermal equilibrium with each other. Gas A is composed of molecules with mass m while gas B is composed of molecules with mass $4m$. The ratio of the average translational kinetic energies K_A/K_B is:
- A. $1/4$
 - B. $1/2$
 - C. 1
 - D. 2
 - E. 4
- ans: C

68. Ideal monatomic gas A is composed of molecules with mass m while ideal monatomic gas B is composed of molecules with mass $4m$. The average translational kinetic energies are the same if the ratio of the temperatures T_A/T_B is:

- A. $1/4$
- B. $1/2$
- C. 1
- D. 2
- E. 4

ans: C

69. Which of the following change when the pressure of an ideal gas is changed isothermally?

- A. Mean free path
- B. Root-mean-square molecular speed
- C. Internal energy
- D. Most probable kinetic energy
- E. Average speed

ans: A

70. When an ideal gas undergoes a slow isothermal expansion:

- A. the work done by the gas is the same as the energy absorbed as heat
- B. the work done by the environment is the same as the energy absorbed as heat
- C. the increase in internal energy is the same as the energy absorbed as heat
- D. the increase in internal energy is the same as the work done by the gas
- E. the increase in internal energy is the same as the work done by the environment

ans: A

71. The pressure of an ideal gas is doubled during a process in which the energy given up as heat by the gas equals the work done on the gas. As a result, the volume is:

- A. doubled
- B. halved
- C. unchanged
- D. need more information to answer
- E. nonsense; the process is impossible

ans: B

72. The energy absorbed as heat by an ideal gas for an isothermal process equals:

- A. the work done by the gas
- B. the work done on the gas
- C. the change in the internal energy of the gas
- D. the negative of the change in internal energy of the gas
- E. zero since the process is isothermal

ans: A

73. An ideal gas has molar specific heat C_p at constant pressure. When the temperature of n moles is increased by ΔT the increase in the internal energy is:
- $nC_p \Delta T$
 - $n(C_p + R) \Delta T$
 - $n(C_p - R) \Delta T$
 - $n(2C_p + R) \Delta T$
 - $n(2C_p - R) \Delta T$
- ans: C
74. The temperature of n moles of an ideal monatomic gas is increased by ΔT at constant pressure. The energy Q absorbed as heat, change ΔE_{int} in internal energy, and work W done by the environment are given by:
- $Q = (5/2)nR \Delta T, \Delta E_{\text{int}} = 0, W = -nR \Delta T$
 - $Q = (3/2)nR \Delta T, \Delta E_{\text{int}} = (5/2)nR \Delta T, W = -(3/2)nR \Delta T$
 - $Q = (5/2)nR \Delta T, \Delta E_{\text{int}} = (5/2)nR \Delta T, W = 0$
 - $Q = (3/2)nR \Delta T, \Delta E_{\text{int}} = 0, W = -nR \Delta T$
 - $Q = (5/2)nR \Delta T, \Delta E_{\text{int}} = (3/2)nR \Delta T, W = -nR \Delta T$
- ans: E
75. The temperature of n moles of an ideal monatomic gas is increased by ΔT at constant volume. The energy Q absorbed as heat, change ΔE_{int} in internal energy, and work W done by the environment are given by:
- $Q = (5/2)nR \Delta T, \Delta E_{\text{int}} = 0, W = 0$
 - $Q = (3/2)nR \Delta T, \Delta E_{\text{int}} = (3/2)nR \Delta T, W = 0$
 - $Q = (3/2)nR \Delta T, \Delta E_{\text{int}} = (1/2)nR \Delta T, W = -nR \Delta T$
 - $Q = (5/2)nR \Delta T, \Delta E_{\text{int}} = (3/2)nR \Delta T, W = -nR \Delta T$
 - $Q = (3/2)nR \Delta T, \Delta E_{\text{int}} = 0, W = -(3/2)nR \Delta T$
- ans: B
76. The heat capacity at constant volume of an ideal gas depends on:
- the temperature
 - the pressure
 - the volume
 - the number of molecules
 - none of the above
- ans: D
77. The specific heat at constant volume of an ideal gas depends on:
- the temperature
 - the pressure
 - the volume
 - the number of molecules
 - none of the above
- ans: E

78. The difference between the molar specific heat at constant pressure and the molar specific heat at constant volume for an ideal gas is:
- A. the Boltzmann constant k
 - B. the universal gas constant R
 - C. the Avogadro constant N_A
 - D. kT
 - E. RT
- ans: B
79. An ideal monatomic gas has a molar specific heat C_v at constant volume of:
- A. R
 - B. $3R/2$
 - C. $5R/2$
 - D. $7R/2$
 - E. $9R/2$
- ans: B
80. The specific heat C_v at constant volume of a monatomic gas at low pressure is proportional to T^n where the exponent n is:
- A. -1
 - B. 0
 - C. 1
 - D. $1/2$
 - E. 2
- ans: B
81. An ideal diatomic gas has a molar specific heat at constant pressure C_p of:
- A. R
 - B. $3R/2$
 - C. $5R/2$
 - D. $7R/2$
 - E. $9R/2$
- ans: D
82. The specific heat of a polyatomic gas is greater than the specific heat of a monatomic gas because:
- A. the polyatomic gas does more positive work when energy is absorbed as heat
 - B. the monatomic gas does more positive work when energy is absorbed as heat
 - C. the energy absorbed by the polyatomic gas is split among more degrees of freedom
 - D. the pressure is greater in the polyatomic gas
 - E. a monatomic gas cannot hold as much heat
- ans: C

83. The ratio of the specific heat of a gas at constant volume to its specific heat at constant pressure is:
- A. 1
 - B. less than 1
 - C. more than 1
 - D. has units of pressure/volume
 - E. has units of volume/pressure
- ans: B
84. The ratio of the specific heat of an ideal gas at constant volume to its specific heat at constant pressure is:
- A. R
 - B. $1/R$
 - C. dependent on the temperature
 - D. dependent on the pressure
 - E. different for monatomic, diatomic, and polyatomic gases
- ans: E
85. Consider the ratios of the heat capacities $\gamma = C_p/C_v$ for the three types of ideal gases: monatomic, diatomic, and polyatomic.
- A. γ is the greatest for monatomic gases
 - B. γ is the greatest for polyatomic gases
 - C. γ is the same only for diatomic and polyatomic gases
 - D. γ is the same only for monatomic and diatomic gases
 - E. γ is the same for all three
- ans: A
86. $TV^{\gamma-1}$ is constant for an ideal gas undergoing an adiabatic process, where γ is the ratio of heat capacities C_p/C_v . This is a direct consequence of:
- A. the zeroth law of thermodynamics alone
 - B. the zeroth law and the ideal gas equation of state
 - C. the first law of thermodynamics alone
 - D. the ideal gas equation of state alone
 - E. the first law and the equation of state
- ans: E
87. Monatomic, diatomic, and polyatomic ideal gases each undergo slow adiabatic expansions from the same initial volume and the same initial pressure to the same final volume. The magnitude of the work done by the environment on the gas:
- A. is greatest for the polyatomic gas
 - B. is greatest for the diatomic gas
 - C. is greatest for the monatomic gas
 - D. is the same only for the diatomic and polyatomic gases
 - E. is the same for all three gases
- ans: A

88. The mean free path of a gas molecule is:
- A. the shortest dimension of the containing vessel
 - B. the cube root of the volume of the containing vessel
 - C. approximately the diameter of a molecule
 - D. average distance between adjacent molecules
 - E. average distance a molecule travels between intermolecular collisions
- ans: E
89. The mean free path of molecules in a gas is:
- A. the average distance a molecule travels before escaping
 - B. the average distance a molecule travels between collisions
 - C. the greatest distance a molecule travels between collisions
 - D. the shortest distance a molecule travels between collisions
 - E. the average distance a molecule travels before splitting apart
- ans: B
90. The mean free path of air molecules at room temperature and atmospheric pressure is about:
- A. 10^{-3} m
 - B. 10^{-5} m
 - C. 10^{-7} m
 - D. 10^{-9} m
 - E. 10^{-11} m
- ans: C
91. The mean free path of molecules in a gas is proportional to:
- A. the molecular cross-sectional area
 - B. the reciprocal of the molecular cross-sectional area
 - C. the root-mean-square molecular speed
 - D. the square of the average molecular speed
 - E. the molar mass
- ans: B
92. The mean free path of molecules in a gas is proportional to:
- A. the molecular diameter
 - B. the reciprocal of the molecular diameter
 - C. the molecular concentration
 - D. the reciprocal of the molecular concentration
 - E. the average molecular speed
- ans: D

93. In a certain gas the molecules are 5.0×10^{-9} m apart on average, have a mean free path of 5.0×10^{-6} m, and have an average speed of 500 m/s. The rate at which a molecule has collisions with other molecules is about:
- A. 10^{-11} s^{-1}
 - B. 10^{-8} s^{-1}
 - C. 1 s^{-1}
 - D. 10^8 s^{-1}
 - E. 10^{11} s^{-1}
- ans: D
94. If the temperature T of an ideal gas is increased at constant pressure the mean free path:
- A. decreases in proportion to $1/T$
 - B. decreases in proportion to $1/T^2$
 - C. increases in proportion to T
 - D. increases in proportion to T^2
 - E. does not change
- ans: C
95. A certain ideal gas has a temperature 300 K and a pressure 5.0×10^4 Pa. The molecules have a mean free path of 4.0×10^{-7} m. If the temperature is raised to 350 K and the pressure is reduced to 1.0×10^4 Pa the mean free path is then:
- A. 6.9×10^{-8} m
 - B. 9.3×10^{-8} m
 - C. 3.3×10^{-7} m
 - D. 1.7×10^{-6} m
 - E. 2.3×10^{-6} m
- ans: E

Chapter 20: ENTROPY AND THE SECOND LAW OF THERMODYNAMICS

- In a reversible process the system:
 - is always close to equilibrium states
 - is close to equilibrium states only at the beginning and end
 - might never be close to any equilibrium state
 - is close to equilibrium states throughout, except at the beginning and end
 - is none of the aboveans: A
- A slow (quasi-static) process is NOT reversible if:
 - the temperature changes
 - energy is absorbed or emitted as heat
 - work is done on the system
 - friction is present
 - the pressure changesans: D
- The difference in entropy $\Delta S = S_B - S_A$ for two states A and B of a system can be computed as the integral $\int dQ/T$ provided:
 - A and B are on the same adiabat
 - A and B have the same temperature
 - a reversible path is used for the integral
 - the change in internal energy is first computed
 - the energy absorbed as heat by the system is first computedans: C
- Possible units of entropy are:
 - J
 - J/K
 - J⁻¹
 - liter·atm
 - cal/molans: B
- Which of the following is NOT a state variable?
 - Work
 - Internal energy
 - Entropy
 - Temperature
 - Pressureans: A

6. The change in entropy is zero for:
- A. reversible adiabatic processes
 - B. reversible isothermal processes
 - C. reversible processes during which no work is done
 - D. reversible isobaric processes
 - E. all adiabatic processes
- ans: A
7. Which of the following processes leads to a change in entropy of zero for the system undergoing the process?
- A. Non-cyclic isobaric (constant pressure)
 - B. Non-cyclic isochoric (constant volume)
 - C. Non-cyclic isothermal (constant temperature)
 - D. Any closed cycle
 - E. None of these
- ans: D
8. Rank, from smallest to largest, the changes in entropy of a pan of water on a hot plate, as the temperature of the water
- 1. goes from 20° C to 30° C
 - 2. goes from 30° C to 40° C
 - 3. goes from 40° C to 45° C
 - 4. goes from 80° C to 85° C
- A. 1, 2, 3, 4
 - B. 4, 3, 2, 1
 - C. 1 and 2 tie, then 3 and 4 tie
 - D. 3 and 4 tie, then 1 and 2 tie
 - E. 4, 3, 2, 1
- ans: E
9. An ideal gas expands into a vacuum in a rigid vessel. As a result there is:
- A. a change in entropy
 - D. an increase of pressure
 - B. a change in temperature
 - E. a decrease of internal energy
 - C. a change in phase
- ans: A
10. Consider all possible isothermal contractions of an ideal gas. The change in entropy of the gas:
- A. is zero for all of them
 - B. does not decrease for any of them
 - C. does not increase for any of them
 - D. increases for all of them
 - E. decreases for all of them
- ans: E

11. An ideal gas is taken reversibly from state i , at temperature T_1 , to any of the other states labeled I, II, III, IV, and V on the p - V diagram below. All are at the same temperature T_2 . Rank the five processes according to the change in entropy of the gas, least to greatest.

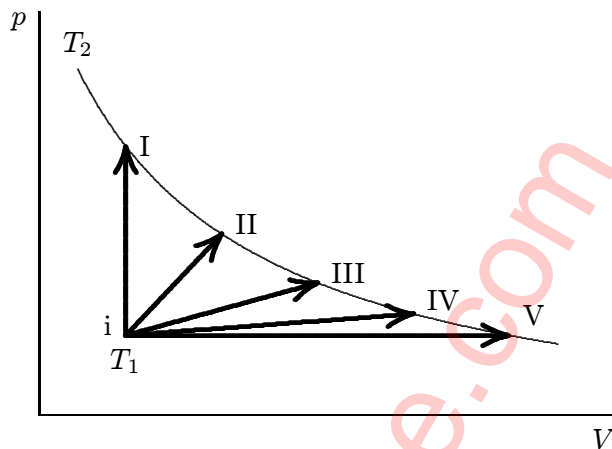

- A. I, II, III, IV, V
 B. V, IV, III, II, I
 C. I, then II, III, IV, and V tied
 D. I, II, III, and IV tied, then V
 E. I and V tied, then II, III, IV

ans: A

12. An ideal gas, consisting of n moles, undergoes a reversible isothermal process during which the volume changes from V_i to V_f . The change in entropy of the thermal reservoir in contact with the gas is given by:

- A. $nR(V_f - V_i)$
 B. $nR \ln(V_f - V_i)$
 C. $nR \ln(V_i/V_f)$
 D. $nR \ln(V_f/V_i)$
 E. none of the above (entropy can't be calculated for a reversible process)

ans: C

13. One mole of an ideal gas expands reversibly and isothermally at temperature T until its volume is doubled. The change of entropy of this gas for this process is:

- A. $R \ln 2$
 B. $(\ln 2)/T$
 C. 0
 D. $RT \ln 2$
 E. $2R$

ans: A

14. An ideal gas, consisting of n moles, undergoes an irreversible process in which the temperature has the same value at the beginning and end. If the volume changes from V_i to V_f , the change in entropy of the gas is given by:
- $nR(V_f - V_i)$
 - $nR \ln(V_f - V_i)$
 - $nR \ln(V_i/V_f)$
 - $nR \ln(V_f/V_i)$
 - none of the above (entropy can't be calculated for an irreversible process)
- ans: D
15. The temperature of n moles of a gas is increased from T_i to T_f at constant volume. If the molar specific heat at constant volume is C_V and is independent of temperature, then change in the entropy of the gas is:
- $nC_V \ln(T_f/T_i)$
 - $nC_V \ln(T_i/T_f)$
 - $nC_V \ln(T_f - T_i)$
 - $nC_V \ln(1 - T_i/T_f)$
 - $nC_V(T_f - T_i)$
- ans: A
16. Consider the following processes: The temperature of two identical gases are increased from the same initial temperature to the same final temperature. Reversible processes are used. For gas A the process is carried out at constant volume while for gas B it is carried out at constant pressure. The change in entropy:
- is the same for A and B
 - is greater for A
 - is greater for B
 - is greater for A only if the initial temperature is low
 - is greater for A only if the initial temperature is high
- ans: C
17. A hot object and a cold object are placed in thermal contact and the combination is isolated. They transfer energy until they reach a common temperature. The change ΔS_h in the entropy of the hot object, the change ΔS_c in the entropy of the cold object, and the change ΔS_{total} in the entropy of the combination are:
- $\Delta S_h > 0, \Delta S_c > 0, \Delta S_{\text{total}} > 0$
 - $\Delta S_h < 0, \Delta S_c > 0, \Delta S_{\text{total}} > 0$
 - $\Delta S_h < 0, \Delta S_c > 0, \Delta S_{\text{total}} < 0$
 - $\Delta S_h > 0, \Delta S_c < 0, \Delta S_{\text{total}} > 0$
 - $\Delta S_h > 0, \Delta S_c < 0, \Delta S_{\text{total}} < 0$
- ans: B

18. Let S_I denote the change in entropy of a sample for an irreversible process from state A to state B. Let S_R denote the change in entropy of the same sample for a reversible process from state A to state B. Then:
- A. $S_I > S_R$
 - B. $S_I = S_R$
 - C. $S_I < S_R$
 - D. $S_I = 0$
 - E. $S_R = 0$
- ans: B
19. For all adiabatic processes:
- A. the entropy of the system does not change
 - B. the entropy of the system increases
 - C. the entropy of the system decreases
 - D. the entropy of the system does not increase
 - E. the entropy of the system does not decrease
- ans: E
20. For all reversible processes involving a system and its environment:
- A. the entropy of the system does not change
 - B. the entropy of the system increases
 - C. the total entropy of the system and its environment does not change
 - D. the total entropy of the system and its environment increases
 - E. none of the above
- ans: C
21. For all irreversible processes involving a system and its environment:
- A. the entropy of the system does not change
 - B. the entropy of the system increases
 - C. the total entropy of the system and its environment does not change
 - D. the total entropy of the system and its environment increases
 - E. none of the above
- ans: D
22. According to the second law of thermodynamics:
- A. heat energy cannot be completely converted to work
 - B. work cannot be completely converted to heat energy
 - C. for all cyclic processes we have $dQ/T < 0$
 - D. the reason all heat engine efficiencies are less than 100% is friction, which is unavoidable
 - E. all of the above are true
- ans: A

23. Consider the following processes:
- I. Energy flows as heat from a hot object to a colder object
 - II. Work is done on a system and an equivalent amount of energy is rejected as heat by the system
 - III. Energy is absorbed as heat by a system and an equivalent amount of work is done by the system
- Which are never found to occur?
- A. Only I
 - B. Only II
 - C. Only III
 - D. Only II and III
 - E. I, II, and III
- ans: C
24. An inventor suggests that a house might be heated by using a refrigerator to draw energy as heat from the ground and reject energy as heat into the house. He claims that the energy supplied to the house as heat can exceed the work required to run the refrigerator. This:
- A. is impossible by first law
 - B. is impossible by second law
 - C. would only work if the ground and the house were at the same temperature
 - D. is impossible since heat energy flows from the (hot) house to the (cold) ground
 - E. is possible
- ans: E
25. In a thermally insulated kitchen, an ordinary refrigerator is turned on and its door is left open. The temperature of the room:
- A. remains constant according to the first law of thermodynamics
 - B. increases according to the first law of thermodynamics
 - C. decreases according to the first law of thermodynamics
 - D. remains constant according to the second law of thermodynamics
 - E. increases according to the second law of thermodynamics
- ans: B
26. A heat engine:
- A. converts heat input to an equivalent amount of work
 - B. converts work to an equivalent amount of heat
 - C. takes heat in, does work, and loses energy as heat
 - D. uses positive work done on the system to transfer heat from a low temperature reservoir to a high temperature reservoir
 - E. uses positive work done on the system to transfer heat from a high temperature reservoir to a low temperature reservoir.
- ans: C

27. A heat engine absorbs energy of magnitude $|Q_H|$ as heat from a high temperature reservoir, does work of magnitude $|W|$, and transfers energy of magnitude $|Q_L|$ as heat to a low temperature reservoir. Its efficiency is:

- A. $|Q_H|/|W|$
- B. $|Q_L|/|W|$
- C. $|Q_H|/|Q_L|$
- D. $|W|/|Q_H|$
- E. $|W|/|Q_L|$

ans: D

28. The temperatures T_C of the cold reservoirs and the temperatures T_H of the hot reservoirs for four Carnot heat engines are

engine 1: $T_C = 400$ K and $T_H = 500$ K

engine 2: $T_C = 500$ K and $T_H = 600$ K

engine 3: $T_C = 400$ K and $T_H = 600$ K

engine 4: $T_C = 600$ K and $T_H = 800$ K

Rank these engines according to their efficiencies, least to greatest

- A. 1, 2, 3, 4
- B. 1 and 2 tie, then 3 and 4 tie
- C. 2, 1, 3, 4
- D. 1, 2, 4, 3
- E. 2, 1, 4, 3

ans: E

29. A Carnot heat engine runs between a cold reservoir at temperature T_C and a hot reservoir at temperature T_H . You want to increase its efficiency. Of the following, which change results in the greatest increase in efficiency? The value of ΔT is the same for all changes.

- A. Raise the temperature of the hot reservoir by ΔT
- B. Raise the temperature of the cold reservoir by ΔT
- C. Lower the temperature of the hot reservoir by ΔT
- D. Lower the temperature of the cold reservoir by ΔT
- E. Lower the temperature of the hot reservoir by $\frac{1}{2}\Delta T$ and raise the temperature of the cold reservoir by $\frac{1}{2}\Delta T$

ans: D

30. 31. A certain heat engine draws 500 cal/s from a water bath at 27° C and transfers 400 cal/s to a reservoir at a lower temperature. The efficiency of this engine is:

- A. 80%
- B. 75%
- C. 55%
- D. 25%
- E. 20%

ans: E

32. A heat engine that in each cycle does positive work and loses energy as heat, with no heat energy input, would violate:
- A. the zeroth law of thermodynamics
 - B. the first law of thermodynamics
 - C. the second law of thermodynamics
 - D. the third law of thermodynamics
 - E. Newton's second law
- ans: B
33. A cyclical process that transfers energy as heat from a high temperature reservoir to a low temperature reservoir with no other change would violate:
- A. the zeroth law of thermodynamics
 - B. the first law of thermodynamics
 - C. the second law of thermodynamics
 - D. the third law of thermodynamics
 - E. none of the above
- ans: E
34. On a warm day a pool of water transfers energy to the air as heat and freezes. This is a direct violation of:
- A. the zeroth law of thermodynamics
 - B. the first law of thermodynamics
 - C. the second law of thermodynamics
 - D. the third law of thermodynamics
 - E. none of the above
- ans: C
35. A heat engine in each cycle absorbs energy of magnitude $|Q_H|$ as heat from a high temperature reservoir, does work of magnitude $|W|$, and then absorbs energy of magnitude $|Q_L|$ as heat from a low temperature reservoir. If $|W| = |Q_H| + |Q_L|$ this engine violates:
- A. the zeroth law of thermodynamics
 - B. the first law of thermodynamics
 - C. the second law of thermodynamics
 - D. the third law of thermodynamics
 - E. none of the above
- ans: C
36. A heat engine in each cycle absorbs energy from a reservoir as heat and does an equivalent amount of work, with no other changes. This engine violates:
- A. the zeroth law of thermodynamics
 - B. the first law of thermodynamics
 - C. the second law of thermodynamics
 - D. the third law of thermodynamics
 - E. none of the above
- ans: C

37. A Carnot cycle:
- A. is bounded by two isotherms and two adiabats on a p - V graph
 - B. consists of two isothermal and two constant volume processes
 - C. is any four-sided process on a p - V graph
 - D. only exists for an ideal gas
 - E. has an efficiency equal to the enclosed area on a p - V diagram
- ans: A
38. According to the second law of thermodynamics:
- A. all heat engines have the same efficiency
 - B. all reversible heat engines have the same efficiency
 - C. the efficiency of any heat engine is independent of its working substance
 - D. the efficiency of a Carnot engine depends only on the temperatures of the two reservoirs
 - E. all Carnot engines theoretically have 100% efficiency
- ans: D
39. A Carnot heat engine operates between 400 K and 500 K. Its efficiency is:
- A. 20%
 - B. 25%
 - C. 44%
 - D. 79%
 - E. 100%
- ans: A
40. A Carnot heat engine operates between a hot reservoir at absolute temperature T_H and a cold reservoir at absolute temperature T_C . Its efficiency is:
- A. T_H/T_C
 - B. T_C/T_H
 - C. $1 - T_H/T_C$
 - D. $1 - T_C/T_H$
 - E. 100%
- ans: D
41. A heat engine operates between a high temperature reservoir at T_H and a low temperature reservoir at T_L . Its efficiency is given by $1 - T_L/T_H$:
- A. only if the working substance is an ideal gas
 - B. only if the engine is reversible
 - C. only if the engine is quasi-static
 - D. only if the engine operates on a Stirling cycle
 - E. no matter what characteristics the engine has
- ans: B

42. The maximum theoretical efficiency of a Carnot heat engine operating between reservoirs at the steam point and at room temperature is about:
- A. 10%
 - B. 20%
 - C. 50%
 - D. 80%
 - E. 99%

ans: B

43. An inventor claims to have a heat engine that has an efficiency of 40% when it operates between a high temperature reservoir of 150°C and a low temperature reservoir of 30°C . This engine:
- A. must violate the zeroth law of thermodynamics
 - B. must violate the first law of thermodynamics
 - C. must violate the second law of thermodynamics
 - D. must violate the third law of thermodynamics
 - E. does not necessarily violate any of the laws of thermodynamics

ans: C

44. A Carnot heat engine and an irreversible heat engine both operate between the same high temperature and low temperature reservoirs. They absorb the same energy from the high temperature reservoir as heat. The irreversible engine:
- A. does more work
 - B. transfers more energy to the low temperature reservoir as heat
 - C. has the greater efficiency
 - D. has the same efficiency as the reversible engine
 - E. cannot absorb the same energy from the high temperature reservoir as heat without violating the second law of thermodynamics

ans: B

45. A perfectly reversible heat pump with a coefficient of performance of 14 supplies energy to a building as heat to maintain its temperature at 27°C . If the pump motor does work at the rate of 1 kW, at what rate does the pump supply energy to the building as heat?
- A. 15 kW
 - B. 3.85 kW
 - C. 1.35 kW
 - D. 1.07 kW
 - E. 1.02 kW

ans: A

46. A heat engine operates between 200 K and 100 K. In each cycle it takes 100 J from the hot reservoir, loses 25 J to the cold reservoir, and does 75 J of work. This heat engine violates:
- A. both the first and second laws of thermodynamics
 - B. the first law but not the second law of thermodynamics
 - C. the second law but not the first law of thermodynamics
 - D. neither the first law nor the second law of thermodynamics
 - E. cannot answer without knowing the mechanical equivalent of heat

ans: C

47. A refrigerator absorbs energy of magnitude $|Q_C|$ as heat from a low temperature reservoir and transfers energy of magnitude $|Q_H|$ as heat to a high temperature reservoir. Work W is done on the working substance. The coefficient of performance is given by:
- A. $|Q_C|/W$
 - B. $|Q_H|/W$
 - C. $(|Q_C| + |Q_H|)/W$
 - D. $W/|Q_C|$
 - E. $W/|Q_H|$
- ans: A
48. A reversible refrigerator operates between a low temperature reservoir at T_C and a high temperature reservoir at T_H . Its coefficient of performance is given by:
- A. $(T_H - T_C)/T_C$
 - B. $T_C/(T_H - T_C)$
 - C. $(T_H - T_C)/T_H$
 - D. $T_H/(T_H - T_C)$
 - E. $T_H(T_H + T_C)$
- ans: B
49. An Carnot refrigerator runs between a cold reservoir at temperature T_C and a hot reservoir at temperature T_H . You want to increase its coefficient of performance. Of the following, which change results in the greatest increase in the coefficient? The value of ΔT is the same for all changes.
- A. Raise the temperature of the hot reservoir by ΔT
 - B. Raise the temperature of the cold reservoir by ΔT
 - C. Lower the temperature of the hot reservoir by ΔT
 - D. Lower the temperature of the cold reservoir by ΔT
 - E. Lower the temperature of the hot reservoir by $\frac{1}{2}\Delta T$ and raise the temperature of the cold reservoir by $\frac{1}{2}\Delta T$
- ans: B
50. For one complete cycle of a reversible heat engine, which of the following quantities is NOT zero?
- A. the change in the entropy of the working gas
 - B. the change in the pressure of the working gas
 - C. the change in the internal energy of the working gas
 - D. the work done by the working gas
 - E. the change in the temperature of the working gas
- ans: D

51. Twenty-five identical molecules are in a box. Microstates are designated by identifying the molecules in the left and right halves of the box. The multiplicity of the configuration with 15 molecules in the right half and 10 molecules in the left half is:
- A. 1.03×10^{23}
 - B. 3.27×10^6
 - C. 150
 - D. 25
 - E. 5
- ans: B
52. Twenty-five identical molecules are in a box. Microstates are designated by identifying the molecules in the left and right halves of the box. The Boltzmann constant is 1.38×10^{-23} J/K. The entropy associated with the configuration for which 15 molecules are in the left half and 10 molecules are in the right half is:
- A. 2.07×10^{-22} J/K
 - B. 7.31×10^{-22} J/K
 - C. 4.44×10^{-23} J/K
 - D. 6.91×10^{-23} J/K
 - E. 2.22×10^{-23} J/K
- ans: A
53. The thermodynamic state of a gas changes from one with 3.8×10^{18} microstates to one with 7.9×10^{19} microstates. The Boltzmann constant is 1.38×10^{-23} J/K. The change in entropy is:
- A. $\Delta S = 0$
 - B. $\Delta S = 1.04 \times 10^{-23}$ J/K
 - C. $\Delta S = -1.04 \times 10^{-23}$ J/K
 - D. $\Delta S = 4.19 \times 10^{-23}$ J/K
 - E. $\Delta S = -4.19 \times 10^{-23}$ J/K
- ans: D
54. Let k be the Boltzmann constant. If the configuration of the molecules in a gas changes so that the multiplicity is reduced to one-third its previous value, the entropy of the gas changes by:
- A. $\Delta S = 0$
 - B. $\Delta S = 3k \ln 2$
 - C. $\Delta S = -3k \ln 2$
 - D. $\Delta S = -k \ln 3$
 - E. $\Delta S = k \ln 3$
- ans: D
55. Let k be the Boltzmann constant. If the configuration of molecules in a gas changes from one with a multiplicity of M_1 to one with a multiplicity of M_2 , then entropy changes by:
- A. $\Delta S = 0$
 - B. $\Delta S = k(M_2 - M_1)$
 - C. $\Delta S = kM_2/M_1$
 - D. $\Delta S = k \ln(M_2 M_1)$
 - E. $\Delta S = k \ln(M_2/M_1)$
- ans: E

56. Let k be the Boltzmann constant. If the thermodynamic state of a gas at temperature T changes isothermally and reversibly to a state with three times the number of microstates as initially, the energy input to the gas as heat is:
- A. $Q = 0$
 - B. $Q = 3kT$
 - C. $Q = -3kT$
 - D. $kT \ln 3$
 - E. $-kT \ln 3$
- ans: D

www.allonlinefree.com

Chapter 21: ELECTRIC CHARGE

1. A coulomb is the same as:
 - A. an ampere/second
 - B. half an ampere-second²
 - C. an ampere/meter²
 - D. an ampere-second
 - E. a newton·meter²ans: D
2. A kiloampere-hour is a unit of:
 - A. current
 - B. charge per time
 - C. power
 - D. charge
 - E. energyans: D
3. The magnitude of the charge on an electron is approximately:
 - A. 10^{23} C
 - B. 10^{-23} C
 - C. 10^{19} C
 - D. 10^{-19} C
 - E. 10^9 Cans: D
4. The total negative charge on the electrons in 1 mol of helium (atomic number 2, molar mass 4) is:
 - A. 4.8×10^4 C
 - B. 9.6×10^4 C
 - C. 1.9×10^5 C
 - D. 3.8×10^5 C
 - E. 7.7×10^5 Cans: C
5. The total negative charge on the electrons in 1 kg of helium (atomic number 2, molar mass 4) is:
 - A. 48 C
 - B. 2.4×10^7 C
 - C. 4.8×10^7 C
 - D. 9.6×10^8 C
 - E. 1.9×10^8 Cans: C

6. A wire carries a steady current of 2 A. The charge that passes a cross section in 2 s is:
- A. 3.2×10^{-19} C
 - B. 6.4×10^{-19} C
 - C. 1 C
 - D. 2 C
 - E. 4 C

ans: E

7. A wire contains a steady current of 2 A. The number of electrons that pass a cross section in 2 s is:
- A. 2
 - B. 4
 - C. 6.3×10^{18}
 - D. 1.3×10^{19}
 - E. 2.5×10^{19}

ans: E

8. The charge on a glass rod that has been rubbed with silk is called positive:
- A. by arbitrary convention
 - B. so that the proton charge will be positive
 - C. to conform to the conventions adopted for G and m in Newton's law of gravitation
 - D. because like charges repel
 - E. because glass is an insulator

ans: A

9. To make an uncharged object have a negative charge we must:
- A. add some atoms
 - B. remove some atoms
 - C. add some electrons
 - D. remove some electrons
 - E. write down a negative sign

ans: C

10. To make an uncharged object have a positive charge:
- A. remove some neutrons
 - B. add some neutrons
 - C. add some electrons
 - D. remove some electrons
 - E. heat it to cause a change of phase

ans: D

11. When a hard rubber rod is given a negative charge by rubbing it with wool:
- A. positive charges are transferred from rod to wool
 - B. negative charges are transferred from rod to wool
 - C. positive charges are transferred from wool to rod
 - D. negative charges are transferred from wool to rod
 - E. negative charges are created and stored on the rod
- ans: D
12. An electrical insulator is a material:
- A. containing no electrons
 - B. through which electrons do not flow easily
 - C. that has more electrons than protons on its surface
 - D. cannot be a pure chemical element
 - E. must be a crystal
- ans: B
13. A conductor is distinguished from an insulator with the same number of atoms by the number of:
- A. nearly free atoms
 - B. electrons
 - C. nearly free electrons
 - D. protons
 - E. molecules
- ans: C
14. The diagram shows two pairs of heavily charged plastic cubes. Cubes 1 and 2 attract each other and cubes 1 and 3 repel each other.

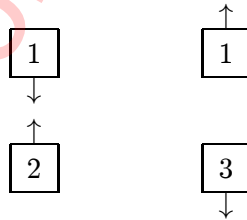

Which of the following illustrates the forces of cube 2 on cube 3 and cube 3 on cube 2?

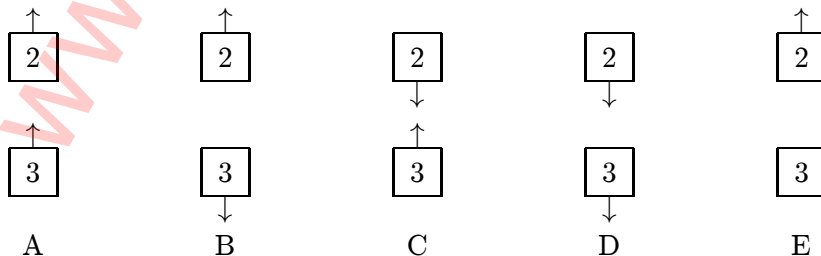

ans: C

15. The diagram shows a pair of heavily charged plastic cubes that attract each other.



Cube 3 is a conductor and is uncharged. Which of the following illustrates the forces between cubes 1 and 3 and between cubes 2 and 3?

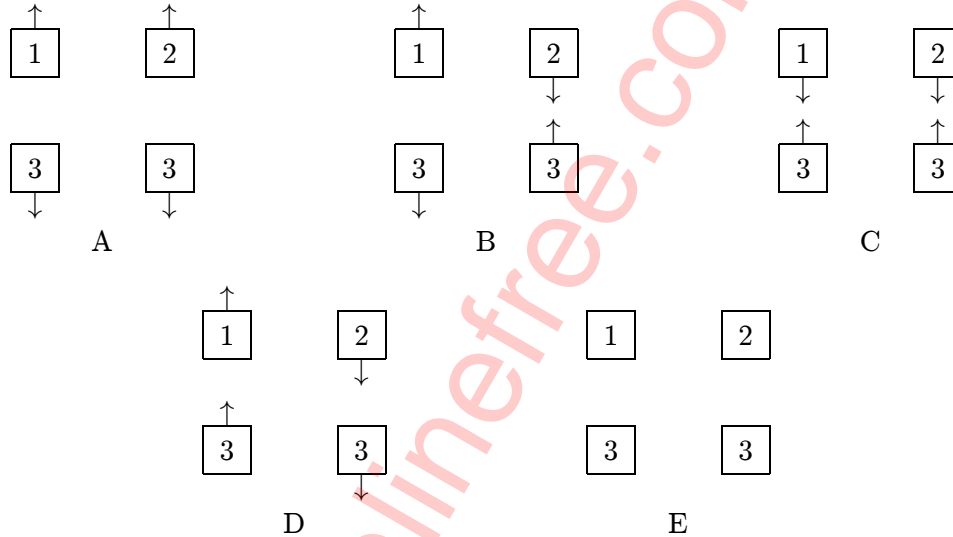

ans: C

16. A neutral metal ball is suspended by a string. A positively charged insulating rod is placed near the ball, which is observed to be attracted to the rod. This is because:
- the ball becomes positively charged by induction
 - the ball becomes negatively charged by induction
 - the number of electrons in the ball is more than the number in the rod
 - the string is not a perfect insulator
 - there is a rearrangement of the electrons in the ball

ans: E

17. A positively charged insulating rod is brought close to an object that is suspended by a string. If the object is attracted toward the rod we can conclude:
- the object is positively charged
 - the object is negatively charged
 - the object is an insulator
 - the object is a conductor
 - none of the above

ans: E

18. A positively charged insulating rod is brought close to an object that is suspended by a string. If the object is repelled away from the rod we can conclude:
- A. the object is positively charged
 - B. the object is negatively charged
 - C. the object is an insulator
 - D. the object is a conductor
 - E. none of the above

ans: A

19. Two uncharged metal spheres, L and M, are in contact. A negatively charged rod is brought close to L, but not touching it, as shown. The two spheres are slightly separated and the rod is then withdrawn. As a result:

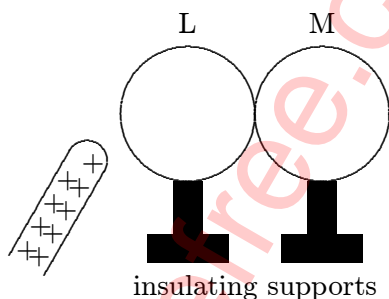

- A. both spheres are neutral
- B. both spheres are positive
- C. both spheres are negative
- D. L is negative and M is positive
- E. L is positive and M is negative

ans: D

20. A positively charged metal sphere A is brought into contact with an uncharged metal sphere B. As a result:
- A. both spheres are positively charged
 - B. A is positively charged and B is neutral
 - C. A is positively charged and B is negatively charged
 - D. A is neutral and B is positively charged
 - E. A is neutral and B is negatively charged

ans: A

21. The leaves of a positively charged electroscope diverge more when an object is brought near the knob of the electroscope. The object must be:
- A. a conductor
 - B. an insulator
 - C. positively charged
 - D. negatively charged
 - E. uncharged

ans: C

22. A negatively charged rubber rod is brought near the knob of a positively charged electroscope. The result is that:
- A. the electroscope leaves will move farther apart
 - B. the rod will lose its charge
 - C. the electroscope leaves will tend to collapse
 - D. the electroscope will become discharged
 - E. nothing noticeable will happen
- ans: C

23. An electroscope is charged by induction using a glass rod that has been made positive by rubbing it with silk. The electroscope leaves:
- A. gain electrons
 - B. gain protons
 - C. lose electrons
 - D. lose protons
 - E. gain an equal number of protons and electrons
- ans: A

24. Consider the following procedural steps:
1. ground an electroscope
 2. remove the ground from the electroscope
 3. touch a charged rod to the electroscope
 4. bring a charged rod near, but not touching, the electroscope
 5. remove the charged rod
- To charge an electroscope by induction, use the sequence:
- A. 1, 4, 5, 2
 - B. 4, 1, 2, 5
 - C. 3, 1, 2, 5
 - D. 4, 1, 5, 2
 - E. 3, 5
- ans: B

25. A charged insulator can be discharged by passing it just above a flame. This is because the flame:
- A. warms it
 - B. dries it
 - C. contains carbon dioxide
 - D. contains ions
 - E. contains more rapidly moving atoms
- ans: D

26. A small object has charge Q . Charge q is removed from it and placed on a second small object. The two objects are placed 1 m apart. For the force that each object exerts on the other to be a maximum, q should be:
- A. $2Q$
 - B. Q
 - C. $Q/2$
 - D. $Q/4$
 - E. 0

ans: C

27. Two small charged objects attract each other with a force F when separated by a distance d . If the charge on each object is reduced to one-fourth of its original value and the distance between them is reduced to $d/2$ the force becomes:
- A. $F/16$
 - B. $F/8$
 - C. $F/4$
 - D. $F/2$
 - E. F

ans: C

28. Two identical conducting spheres A and B carry equal charge. They are separated by a distance much larger than their diameters. A third identical conducting sphere C is uncharged. Sphere C is first touched to A, then to B, and finally removed. As a result, the electrostatic force between A and B, which was originally F , becomes:
- A. $F/2$
 - B. $F/4$
 - C. $3F/8$
 - D. $F/16$
 - E. 0

ans: C

29. Two particles, X and Y, are 4 m apart. X has a charge of $2Q$ and Y has a charge of Q . The force of X on Y:
- A. has twice the magnitude of the force of Y on X
 - B. has half the magnitude of the force of Y on X
 - C. has four times the magnitude of the force of Y on X
 - D. has one-fourth the magnitude of the force of Y on X
 - E. has the same magnitude as the force of Y on X

ans: E

30. The units of $1/4\pi\epsilon_0$ are:
- A. N^2C^2
 - B. $N \cdot m/C$
 - C. $N^2 \cdot m^2/C^2$
 - D. $N \cdot m^2/C^2$
 - E. m^2/C^2

ans: D

31. A 5.0-C charge is 10 m from a -2.0-C charge. The electrostatic force on the positive charge is:
- $9.0 \times 10^8 \text{ N}$ toward the negative charge
 - $9.0 \times 10^8 \text{ N}$ away from the negative charge
 - $9.0 \times 10^9 \text{ N}$ toward the negative charge
 - $9.0 \times 10^9 \text{ N}$ away from the negative charge
 - none of these

ans: A

32. Two identical charges, 2.0 m apart, exert forces of magnitude 4.0 N on each other. The value of either charge is:
- $1.8 \times 10^{-9} \text{ C}$
 - $2.1 \times 10^{-5} \text{ C}$
 - $4.2 \times 10^{-5} \text{ C}$
 - $1.9 \times 10^5 \text{ C}$
 - $3.8 \times 10^5 \text{ C}$

ans: C

33. Two electrons (e_1 and e_2) and a proton (p) lie on a straight line, as shown. The directions of the force of e_2 on e_1 , the force of p on e_1 , and the total force on e_1 , respectively, are:

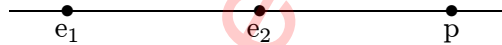

- $\rightarrow, \leftarrow, \rightarrow$
- $\leftarrow, \rightarrow, \rightarrow$
- $\rightarrow, \leftarrow, \leftarrow$
- $\leftarrow, \rightarrow, \leftarrow$
- $\leftarrow, \leftarrow, \leftarrow$

ans: D

34. Two protons (p_1 and p_2) and an electron (e) lie on a straight line, as shown. The directions of the force of p_1 on e , the force of p_2 on e , and the total force on e , respectively, are:

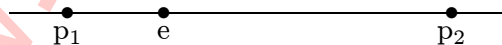

- $\rightarrow, \leftarrow, \rightarrow$
- $\leftarrow, \rightarrow, \rightarrow$
- $\rightarrow, \leftarrow, \leftarrow$
- $\leftarrow, \rightarrow, \leftarrow$
- $\leftarrow, \leftarrow, \leftarrow$

ans: D

35. Two particles have charges Q and $-Q$ (equal magnitude and opposite sign). For a net force of zero to be exerted on a third charge it must be placed:
- A. midway between Q and $-Q$
 - B. on the perpendicular bisector of the line joining Q and $-Q$, but not on that line itself
 - C. on the line joining Q and $-Q$, to the side of Q opposite $-Q$
 - D. on the line joining Q and $-Q$, to the side of $-Q$ opposite Q
 - E. at none of these places (there is no place)
- ans: E
36. Particles 1, with charge q_1 , and 2, with charge q_2 , are on the x axis, with particle 1 at $x = a$ and particle 2 at $x = -2a$. For the net force on a third charged particle, at the origin, to be zero, q_1 and q_2 must be related by $q_2 =$:
- A. $2q_1$
 - B. $4q_1$
 - C. $-2q_1$
 - D. $-4q_1$
 - E. $-q_1/4$
- ans: B
37. Two particles A and B have identical charge Q . For a net force of zero to be exerted on a third charged particle it must be placed:
- A. midway between A and B
 - B. on the perpendicular bisector of the line joining A and B but away from the line
 - C. on the line joining A and B, not between the particles
 - D. on the line joining A and B, closer to one of them than the other
 - E. at none of these places (there is no place)
- ans: A
38. A particle with charge $2\text{-}\mu\text{C}$ is placed at the origin, an identical particle, with the same charge, is placed 2 m from the origin on the x axis, and a third identical particle, with the same charge, is placed 2 m from the origin on the y axis. The magnitude of the force on the particle at the origin is:
- A. $9.0 \times 10^{-3} \text{ N}$
 - B. $6.4 \times 10^{-3} \text{ N}$
 - C. $1.3 \times 10^{-2} \text{ N}$
 - D. $1.8 \times 10^{-2} \text{ N}$
 - E. $3.6 \times 10^{-2} \text{ N}$
- ans: C
39. Charge Q is spread uniformly along the circumference of a circle of radius R . A point particle with charge q is placed at the center of this circle. The total force exerted on the particle can be calculated by Coulomb's law:
- A. just use R for the distance
 - B. just use $2R$ for the distance
 - C. just use $2\pi R$ for the distance
 - D. the result of the calculation is zero
 - E. none of the above
- ans: D

40. Two particles, each with charge Q , and a third particle, with charge q , are placed at the vertices of an equilateral triangle as shown. The total force on the particle with charge q is:

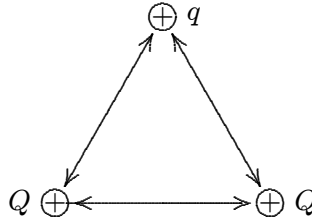

- A. parallel to the left side of the triangle
 B. parallel to the right side of the triangle
 C. parallel to the bottom side of the triangle
 D. perpendicular to the bottom side of the triangle
 E. perpendicular to the left side of the triangle

ans: D

41. A particle with charge Q is on the y axis a distance a from the origin and a particle with charge q is on the x axis a distance d from the origin. The value of d for which the x component of the force on the second particle is the greatest is:

- A. 0
 B. a
 C. $\sqrt{2}a$
 D. $a/2$
 E. $a/\sqrt{2}$

ans: E

42. In the Rutherford model of the hydrogen atom, a proton (mass M , charge Q) is the nucleus and an electron (mass m , charge q) moves around the proton in a circle of radius r . Let k denote the Coulomb force constant ($1/4\pi\epsilon_0$) and G the universal gravitational constant. The ratio of the electrostatic force to the gravitational force between electron and proton is:

- A. $kQq/GMmr^2$
 B. GQq/kMm
 C. kMm/GQq
 D. GMm/kQq
 E. kQq/GMm

ans: E

43. A particle with a charge of 5×10^{-6} C and a mass of 20 g moves uniformly with a speed of 7 m/s in a circular orbit around a stationary particle with a charge of -5×10^{-6} C. The radius of the orbit is:

- A. 0
 B. 0.23 m
 C. 0.62 m
 D. 1.6
 E. 4.4 m

ans: B

44. Charge is distributed uniformly on the surface of a spherical balloon (an insulator). A point particle with charge q is inside. The electrical force on the particle is greatest when:
- A. it is near the inside surface of the balloon
 - B. it is at the center of the balloon
 - C. it is halfway between the balloon center and the inside surface
 - D. it is anywhere inside (the force is same everywhere and is not zero)
 - E. it is anywhere inside (the force is zero everywhere)
- ans: E

45. Charge is distributed on the surface of a spherical conducting shell. A point particle with charge q is inside. If polarization effects are negligible the electrical force on the particle is greatest when:
- A. it is near the inside surface of the balloon
 - B. it is at the center of the balloon
 - C. it is halfway between the balloon center and the inside surface
 - D. it is anywhere inside (the force is same everywhere and is not zero)
 - E. it is anywhere inside (the force is zero everywhere)
- ans: A

Chapter 22: ELECTRIC FIELDS

- An electric field is most directly related to:
 - the momentum of a test charge
 - the kinetic energy of a test charge
 - the potential energy of a test charge
 - the force acting on a test charge
 - the charge carried by a test chargeans: D
- As used in the definition of electric field, a “test charge”:
 - has zero charge
 - has charge of magnitude 1 C
 - has charge of magnitude 1.6×10^{-19} C
 - must be an electron
 - none of the aboveans: E
- Experimenter A uses a test charge q_0 and experimenter B uses a test charge $-2q_0$ to measure an electric field produced by stationary charges. A finds a field that is:
 - the same in both magnitude and direction as the field found by B
 - greater in magnitude than the field found by B
 - less in magnitude than the field found by B
 - opposite in direction to the field found by B
 - either greater or less than the field found by B, depending on the accelerations of the test chargesans: A
- The units of the electric field are:
 - $\text{N} \cdot \text{C}^2$
 - C/N
 - N
 - N/C
 - C/m^2ans: D
- The units of the electric field are:
 - $\text{J}/(\text{C} \cdot \text{m})$
 - J/C
 - $\text{J} \cdot \text{C}$
 - J/m
 - none of theseans: A

6. Electric field lines:
- A. are trajectories of a test charge
 - B. are vectors in the direction of the electric field
 - C. form closed loops
 - D. cross each other in the region between two point charges
 - E. are none of the above

ans: E

7. Two thin spherical shells, one with radius R and the other with radius $2R$, surround an isolated charged point particle. The ratio of the number of field lines through the larger sphere to the number through the smaller is:

- A. 1
- B. 2
- C. 4
- D. $1/2$
- E. $1/4$

ans: A

8. A certain physics textbook shows a region of space in which two electric field lines cross each other. We conclude that:

- A. at least two point charges are present
- B. an electrical conductor is present
- C. an insulator is present
- D. the field points in two directions at the same place
- E. the author made a mistake

ans: E

9. Choose the correct statement concerning electric field lines:

- A. field lines may cross
- B. field lines are close together where the field is large
- C. field lines point away from a negatively charged particle
- D. a charged point particle released from rest moves along a field line
- E. none of these are correct

ans: B

10. The diagram shows the electric field lines due to two charged parallel metal plates. We conclude that:

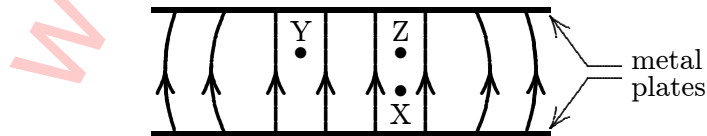

- A. the upper plate is positive and the lower plate is negative
- B. a proton at X would experience the same force if it were placed at Y
- C. a proton at X experiences a greater force than if it were placed at Z
- D. a proton at X experiences less force than if it were placed at Z
- E. an electron at X could have its weight balanced by the electrical force

ans: B

11. Let k denote $1/4\pi\epsilon_0$. The magnitude of the electric field at a distance r from an isolated point particle with charge q is:
- A. kq/r
 - B. kr/q
 - C. kq/r^3
 - D. kq/r^2
 - E. kq^2/r^2
- ans: D

12. The diagram shows the electric field lines in a region of space containing two small charged spheres (Y and Z). Then:

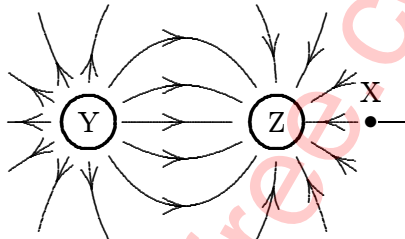

- A. Y is negative and Z is positive
 - B. the magnitude of the electric field is the same everywhere
 - C. the electric field is strongest midway between Y and Z
 - D. the electric field is not zero anywhere (except infinitely far from the spheres)
 - E. Y and Z must have the same sign
- ans: D
13. The diagram shows the electric field lines in a region of space containing two small charged spheres (Y and Z). Then:

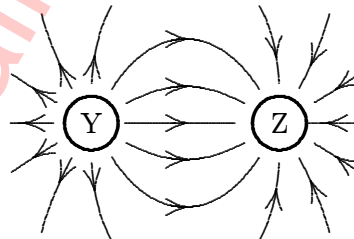

- A. Y is negative and Z is positive
 - B. the magnitude of the electric field is the same everywhere
 - C. the electric field is strongest midway between Y and Z
 - D. Y is positive and Z is negative
 - E. Y and Z must have the same sign
- ans: D

14. The electric field at a distance of 10 cm from an isolated point particle with a charge of 2×10^{-9} C is:
- 1.8 N/C
 - 180 N/C
 - 18 N/C
 - 1800 N/C
 - none of these

ans: D

15. An isolated charged point particle produces an electric field with magnitude E at a point 2 m away from the charge. A point at which the field magnitude is $E/4$ is:
- 1 m away from the particle
 - 0.5 m away from the particle
 - 2 m away from the particle
 - 4 m away from the particle
 - 8 m away from the particle

ans: D

16. An isolated charged point particle produces an electric field with magnitude E at a point 2 m away. At a point 1 m from the particle the magnitude of the field is:
- E
 - $2E$
 - $4E$
 - $E/2$
 - $E/4$

ans: C

17. Two protons (p_1 and p_2) are on the x axis, as shown below. The directions of the electric field at points 1, 2, and 3, respectively, are:

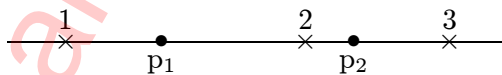

- $\rightarrow, \leftarrow, \rightarrow$
- $\leftarrow, \rightarrow, \leftarrow$
- $\leftarrow, \rightarrow, \rightarrow$
- $\leftarrow, \leftarrow, \leftarrow$
- $\leftarrow, \leftarrow, \rightarrow$

ans: E

18. Two point particles, with a charges of q_1 and q_2 , are placed a distance r apart. The electric field is zero at a point P between the particles on the line segment connecting them. We conclude that:
- q_1 and q_2 must have the same magnitude and sign
 - P must be midway between the particles
 - q_1 and q_2 must have the same sign but may have different magnitudes
 - q_1 and q_2 must have equal magnitudes and opposite signs
 - q_1 and q_2 must have opposite signs and may have different magnitudes
- ans: C

19. The diagrams below depict four different charge distributions. The charge particles are all the same distance from the origin. The electric field at the origin:

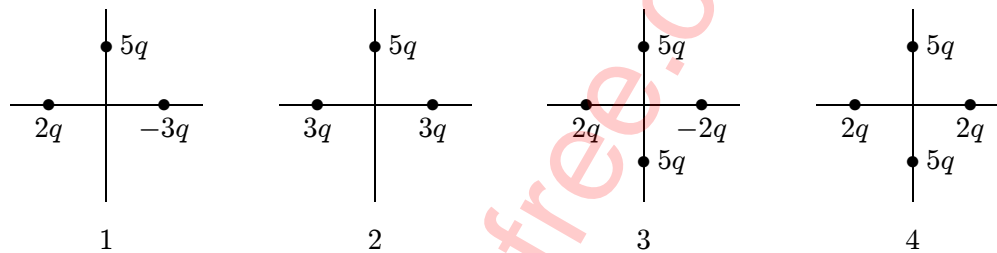

- is greatest for situation 1
 - is greatest for situation 3
 - is zero for situation 4
 - is downward for situation 1
 - is downward for situation 3
- ans: C

20. The diagram shows a particle with positive charge Q and a particle with negative charge $-Q$. The electric field at point P on the perpendicular bisector of the line joining them is:

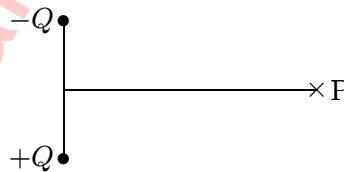

- \uparrow
 - \downarrow
 - \rightarrow
 - \leftarrow
 - zero
- ans: A

21. The diagram shows two identical particles, each with positive charge Q . The electric field at point P on the perpendicular bisector of the line joining them is:

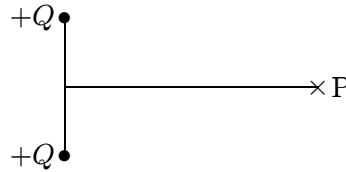

- A. \uparrow
B. \downarrow
C. \rightarrow
D. \leftarrow
E. zero
ans: C
22. Two point particles, one with charge $+8 \times 10^{-9} \text{ C}$ and the other with charge $-2 \times 10^{-9} \text{ C}$, are separated by 4 m. The electric field in N/C midway between them is:
A. 9×10^9
B. 13,500
C. 135,000
D. 36×10^{-9}
E. 22.5
ans: E
23. Two charged point particles are located at two vertices of an equilateral triangle and the electric field is zero at the third vertex. We conclude:
A. the two particles have charges with opposite signs and the same magnitude
B. the two particles have charges with opposite signs and different magnitudes
C. the two particles have identical charges
D. the two particles have charges with the same sign but different magnitudes
E. at least one other charged particle is present
ans: E
24. Two point particles, with the same charge, are located at two vertices of an equilateral triangle. A third charged particle is placed so the electric field at the third vertex is zero. The third particle must:
A. be on the perpendicular bisector of the line joining the first two charges
B. be on the line joining the first two charges
C. have the same charge as the first two particles
D. have charge of the same magnitude as the first two charges but its charge may have a different sign
E. be at the center of the triangle
ans: A

25. Positive charge Q is uniformly distributed on a semicircular rod. What is the direction of the electric field at point P, the center of the semicircle?

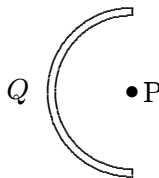

- A. \uparrow
 B. \downarrow
 C. \leftarrow
 D. \rightarrow
 E. \nearrow

ans: D

26. Positive charge $+Q$ is uniformly distributed on the upper half a semicircular rod and negative charge $-Q$ is uniformly distributed on the lower half. What is the direction of the electric field at point P, the center of the semicircle?

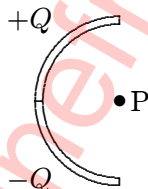

- A. \uparrow
 B. \downarrow
 C. \leftarrow
 D. \rightarrow
 E. \nearrow

ans: B

27. Positive charge $+Q$ is uniformly distributed on the upper half a rod and negative charge $-Q$ is uniformly distributed on the lower half. What is the direction of the electric field at point P, on the perpendicular bisector of the rod?

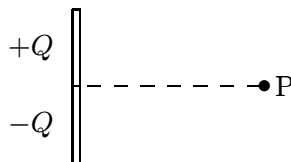

- A. \uparrow
 B. \downarrow
 C. \leftarrow
 D. \rightarrow
 E. \nearrow

ans: B

28. The electric field due to a uniform distribution of charge on a spherical shell is zero:
- A. everywhere
 - B. nowhere
 - C. only at the center of the shell
 - D. only inside the shell
 - E. only outside the shell
- ans: D
29. A charged particle is placed in an electric field that varies with location. No force is exerted on this charge:
- A. at locations where the electric field is zero
 - B. at locations where the electric field strength is $1/(1.6 \times 10^{-19})$ N/C
 - C. if the particle is moving along a field line
 - D. if the particle is moving perpendicularly to a field line
 - E. if the field is caused by an equal amount of positive and negative charge
- ans: A
30. The magnitude of the force of a 400-N/C electric field on a 0.02-C point charge is:
- A. 8.0 N
 - B. 8×10^{-5} N
 - C. 8×10^{-3} N
 - D. 0.08 N
 - E. 2×10^{11} N
- ans: A
31. A 200-N/C electric field is in the positive x direction. The force on an electron in this field is:
- A. 200 N in the positive x direction
 - B. 200 N in the negative x direction
 - C. 3.2×10^{-17} N in the positive x direction
 - D. 3.2×10^{-17} N in the negative x direction
 - E. 0
- ans: D
32. An electron traveling north enters a region where the electric field is uniform and points north. The electron:
- A. speeds up
 - B. slows down
 - C. veers east
 - D. veers west
 - E. continues with the same speed in the same direction
- ans: B

33. An electron traveling north enters a region where the electric field is uniform and points west. The electron:
- speeds up
 - slows down
 - veers east
 - veers west
 - continues with the same speed in the same direction
- ans: C

34. Two charged particles are arranged as shown. In which region could a third particle, with charge $+1\text{ C}$, be placed so that the net electrostatic force on it is zero?

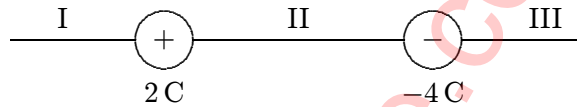

- I only
 - I and II only
 - III only
 - I and III only
 - II only
- ans: A
35. An electric dipole consists of a particle with a charge of $+6 \times 10^{-6}\text{ C}$ at the origin and a particle with a charge of $-6 \times 10^{-6}\text{ C}$ on the x axis at $x = 3 \times 10^{-3}\text{ m}$. Its dipole moment is:
- $1.8 \times 10^{-8}\text{ C} \cdot \text{m}$, in the positive x direction
 - $1.8 \times 10^{-8}\text{ C} \cdot \text{m}$, in the negative x direction
 - 0 because the net charge is 0
 - $1.8 \times 10^{-8}\text{ C} \cdot \text{m}$, in the positive y direction
 - $1.8 \times 10^{-8}\text{ C} \cdot \text{m}$, in the negative y direction
- ans: B

36. The force exerted by a uniform electric field on a dipole is:
- parallel to the dipole moment
 - perpendicular to the dipole moment
 - parallel to the electric field
 - perpendicular to the electric field
 - none of the above
- ans: E

37. An electric field exerts a torque on a dipole only if:
- the field is parallel to the dipole moment
 - the field is not parallel to the dipole moment
 - the field is perpendicular to the dipole moment
 - the field is not perpendicular to the dipole moment
 - the field is uniform
- ans: B

38. The torque exerted by an electric field on a dipole is:
- parallel to the field and perpendicular to the dipole moment
 - parallel to both the field and dipole moment
 - perpendicular to both the field and dipole moment
 - parallel to the dipole moment and perpendicular to the field
 - not related to the directions of the field and dipole moment

ans: C

39. The diagrams show four possible orientations of an electric dipole in a uniform electric field \vec{E} . Rank them according to the magnitude of the torque exerted on the dipole by the field, least to greatest.

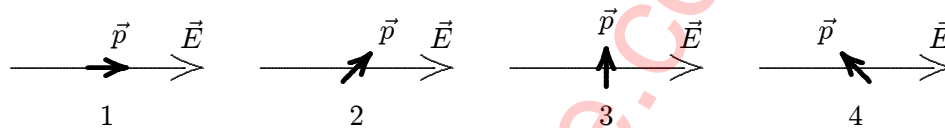

- 1, 2, 3, 4
- 4, 3, 2, 1
- 1, 2, 4, 3
- 3, 2 and 4 tie, then 1
- 1, 2 and 4 tie, then 3

ans: E

40. A uniform electric field of 300 N/C makes an angle of 25° with the dipole moment of an electric dipole. If the torque exerted by the field has a magnitude of $2.5 \times 10^{-7} \text{ N}\cdot\text{m}$, the dipole moment must be:

- $8.3 \times 10^{-10} \text{ C}\cdot\text{m}$
- $9.2 \times 10^{-10} \text{ C}\cdot\text{m}$
- $2.0 \times 10^{-9} \text{ C}\cdot\text{m}$
- $8.3 \times 10^{-5} \text{ C}\cdot\text{m}$
- $1.8 \times 10^{-4} \text{ C}\cdot\text{m}$

ans: C

41. When the dipole moment of a dipole in a uniform electric field rotates to become more nearly aligned with the field:

- the field does positive work and the potential energy increases
- the field does positive work and the potential energy decreases
- the field does negative work and the potential energy increases
- the field does negative work and the potential energy decreases
- the field does no work

ans: B

42. The dipole moment of a dipole in a 300-N/C electric field is initially perpendicular to the field, but it rotates so it is in the same direction as the field. If the moment has a magnitude of $2 \times 10^{-9} \text{ C} \cdot \text{m}$, the work done by the field is:
- $-12 \times 10^{-7} \text{ J}$
 - $-6 \times 10^{-7} \text{ J}$
 - 0
 - $6 \times 10^{-7} \text{ J}$
 - $12 \times 10^{-7} \text{ J}$
- ans: D

43. An electric dipole is oriented parallel to a uniform electric field, as shown.

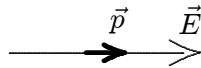

It is rotated to one of the five orientations shown below. Rank the final orientations according to the change in the potential energy of the dipole-field system, most negative to most positive.

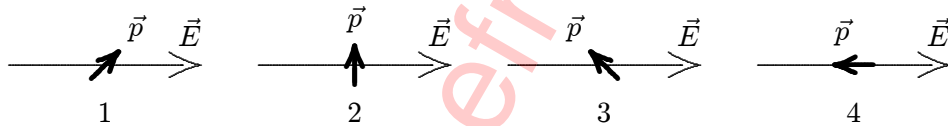

- 1, 2, 3, 4
 - 4, 3, 2, 1
 - 1, 2, 4, 3
 - 3, 2 and 4 tie, then 1
 - 1, 2 and 4 tie, then 3
- ans: A
44. The purpose of Milliken's oil drop experiment was to determine:
- the mass of an electron
 - the charge of an electron
 - the ratio of charge to mass for an electron
 - the sign of the charge on an electron
 - viscosity
- ans: B
45. A charged oil drop with a mass of $2 \times 10^{-4} \text{ kg}$ is held suspended by a downward electric field of 300 N/C. The charge on the drop is:
- $+1.5 \times 10^{-6} \text{ C}$
 - $-1.5 \times 10^{-6} \text{ C}$
 - $+6.5 \times 10^{-6} \text{ C}$
 - $-6.5 \times 10^{-6} \text{ C}$
 - 0
- ans: D

Chapter 23: GAUSS' LAW

- A total charge of 6.3×10^{-8} C is distributed uniformly throughout a 2.7-cm radius sphere. The volume charge density is:
 - 3.7×10^{-7} C/m³
 - 6.9×10^{-6} C/m³
 - 6.9×10^{-6} C/m²
 - 2.5×10^{-4} C/m³
 - 7.6×10^{-4} C/m³ans: E
- Charge is placed on the surface of a 2.7-cm radius isolated conducting sphere. The surface charge density is uniform and has the value 6.9×10^{-6} C/m². The total charge on the sphere is:
 - 5.6×10^{-10} C
 - 2.1×10^{-8} C
 - 4.7×10^{-8} C
 - 6.3×10^{-8} C
 - 9.5×10^{-3} Cans: D
- A spherical shell has an inner radius of 3.7 cm and an outer radius of 4.5 cm. If charge is distributed uniformly throughout the shell with a volume density of 6.1×10^{-4} C/m³ the total charge is:
 - 1.0×10^{-7} C
 - 1.3×10^{-7} C
 - 2.0×10^{-7} C
 - 2.3×10^{-7} C
 - 4.0×10^{-7} Cans: A
- A cylinder has a radius of 2.1 cm and a length of 8.8 cm. Total charge 6.1×10^{-7} C is distributed uniformly throughout. The volume charge density is:
 - 5.3×10^{-5} C/m³
 - 5.3×10^{-5} C/m²
 - 8.5×10^{-4} C/m³
 - 5.0×10^{-3} C/m³
 - 6.3×10^{-2} C/m³ans: D

5. When a piece of paper is held with one face perpendicular to a uniform electric field the flux through it is $25 \text{ N} \cdot \text{m}^2/\text{C}$. When the paper is turned 25° with respect to the field the flux through it is:
- 0
 - $12 \text{ N} \cdot \text{m}^2/\text{C}$
 - $21 \text{ N} \cdot \text{m}^2/\text{C}$
 - $23 \text{ N} \cdot \text{m}^2/\text{C}$
 - $25 \text{ N} \cdot \text{m}^2/\text{C}$
- ans: D
6. The flux of the electric field $(24 \text{ N/C})\hat{i} + (30 \text{ N/C})\hat{j} + (16 \text{ N/C})\hat{k}$ through a 2.0 m^2 portion of the yz plane is:
- $32 \text{ N} \cdot \text{m}^2/\text{C}$
 - $34 \text{ N} \cdot \text{m}^2/\text{C}$
 - $42 \text{ N} \cdot \text{m}^2/\text{C}$
 - $48 \text{ N} \cdot \text{m}^2/\text{C}$
 - $60 \text{ N} \cdot \text{m}^2/\text{C}$
- ans: D
7. Consider Gauss's law: $\oint \vec{E} \cdot d\vec{A} = q/\epsilon_0$. Which of the following is true?
- \vec{E} must be the electric field due to the enclosed charge
 - If $q = 0$, then $\vec{E} = 0$ everywhere on the Gaussian surface
 - If the three particles inside have charges of $+q$, $+q$, and $-2q$, then the integral is zero
 - on the surface \vec{E} is everywhere parallel to $d\vec{A}$
 - If a charge is placed outside the surface, then it cannot affect \vec{E} at any point on the surface
- ans: C
8. A charged point particle is placed at the center of a spherical Gaussian surface. The electric flux Φ_E is changed if:
- the sphere is replaced by a cube of the same volume
 - the sphere is replaced by a cube of one-tenth the volume
 - the point charge is moved off center (but still inside the original sphere)
 - the point charge is moved to just outside the sphere
 - a second point charge is placed just outside the sphere
- ans: D
9. Choose the INCORRECT statement:
- Gauss' law can be derived from Coulomb's law
 - Gauss' law states that the net number of lines crossing any closed surface in an outward direction is proportional to the net charge enclosed within the surface
 - Coulomb's law can be derived from Gauss' law and symmetry
 - Gauss' law applies to a closed surface of any shape
 - According to Gauss' law, if a closed surface encloses no charge, then the electric field must vanish everywhere on the surface
- ans: E

10. The outer surface of the cardboard center of a paper towel roll:
- A. is a possible Gaussian surface
 - B. cannot be a Gaussian surface because it encloses no charge
 - C. cannot be a Gaussian surface since it is an insulator
 - D. cannot be a Gaussian surface because it is not a closed surface
 - E. none of the above
- ans: D
11. A physics instructor in an anteroom charges an electrostatic generator to $25\ \mu\text{C}$, then carries it into the lecture hall. The net electric flux in $\text{N} \cdot \text{m}^2/\text{C}$ through the lecture hall walls is:
- A. 0
 - B. 25×10^{-6}
 - C. 2.2×10^5
 - D. 2.8×10^6
 - E. can not tell unless the lecture hall dimensions are given
- ans: D
12. A point particle with charge q is placed inside the cube but not at its center. The electric flux through any one side of the cube:
- A. is zero
 - B. is q/ϵ_0
 - C. is $q/4\epsilon_0$
 - D. is $q/6\epsilon_0$
 - E. cannot be computed using Gauss' law
- ans: E
13. A particle with charge $5.0\text{-}\mu\text{C}$ is placed at the corner of a cube. The total electric flux in $\text{N} \cdot \text{m}^2/\text{C}$ through all sides of the cube is:
- A. 0
 - B. 7.1×10^4
 - C. 9.4×10^4
 - D. 1.4×10^5
 - E. 5.6×10^5
- ans: E
14. A point particle with charge q is at the center of a Gaussian surface in the form of a cube. The electric flux through any one face of the cube is:
- A. q/ϵ_0
 - B. $q/4\pi\epsilon_0$
 - C. $q/3\epsilon_0$
 - D. $q/6\epsilon_0$
 - E. $q/12\epsilon_0$
- ans: D

15. The table below gives the electric flux in $\text{N} \cdot \text{m}^2/\text{C}$ through the ends and round surfaces of four Gaussian surfaces in the form of cylinders. Rank the cylinders according to the charge inside, from the most negative to the most positive.

	<u>left end</u>	<u>right end</u>	<u>rounded surface</u>
cylinder 1:	$+2 \times 10^{-9}$	$+4 \times 10^{-9}$	-6×10^{-9}
cylinder 2:	$+3 \times 10^{-9}$	-2×10^{-9}	$+6 \times 10^{-9}$
cylinder 3:	-2×10^{-9}	-5×10^{-9}	$+3 \times 10^{-9}$
cylinder 4:	$+2 \times 10^{-9}$	-5×10^{-9}	-3×10^{-9}

- A. 1, 2, 3, 4
 B. 4, 3, 2, 1
 C. 3, 4, 2, 1
 D. 3, 1, 4, 2
 E. 4, 3, 1, 2

ans: E

16. A conducting sphere of radius 0.01 m has a charge of $1.0 \times 10^{-9} \text{ C}$ deposited on it. The magnitude of the electric field in N/C just outside the surface of the sphere is:

- A. 0
 B. 450
 C. 900
 D. 4500
 E. 90,000

ans: C

17. A round wastepaper basket with a 0.15-m radius opening is in a uniform electric field of $300 \text{ N}/\text{C}$, perpendicular to the opening. The total flux through the sides and bottom, in $\text{N} \cdot \text{m}^2/\text{C}$, is:

- A. 0
 B. 4.2
 C. 21
 D. 280
 E. can not tell without knowing the areas of the sides and bottom

ans: C

18. 10 C of charge are placed on a spherical conducting shell. A particle with a charge of -3 C is placed at the center of the cavity. The net charge on the inner surface of the shell is:

- A. -7 C
 B. -3 C
 C. 0 C
 D. $+3 \text{ C}$
 E. $+7 \text{ C}$

ans: D

19. 10 C of charge are placed on a spherical conducting shell. A particle with a charge of -3 C is placed at the center of the cavity. The net charge on the outer surface of the shell is:
- -7 C
 - -3 C
 - 0 C
 - $+3\text{ C}$
 - $+7\text{ C}$

ans: E

20. A 30-N/C uniform electric field points perpendicularly toward the left face of a large neutral conducting sheet. The surface charge density in C/m^2 on the left and right faces, respectively, are:
- $-2.7 \times 10^{-9}\text{ C/m}^2$; $+2.7 \times 10^{-9}\text{ C/m}^2$
 - $+2.7 \times 10^{-9}\text{ C/m}^2$; $-2.7 \times 10^{-9}\text{ C/m}^2$
 - $-5.3 \times 10^{-9}\text{ C/m}^2$; $+5.3 \times 10^{-9}\text{ C/m}^2$
 - $+5.3 \times 10^{-9}\text{ C/m}^2$; $-5.3 \times 10^{-9}\text{ C/m}^2$
 - 0; 0

ans: A

21. A solid insulating sphere of radius R contains positive charge that is distributed with a volume charge density that does not depend on angle but does increase with distance from the sphere center. Which of the graphs below might give the magnitude E of the electric field as a function of the distance r from the center of the sphere?

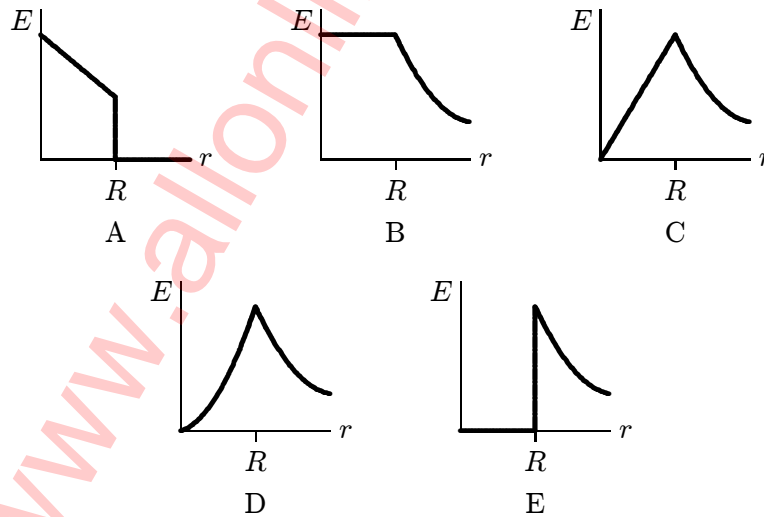

ans: D

22. Which of the following graphs represents the magnitude of the electric field as a function of the distance from the center of a solid charged conducting sphere of radius R ?

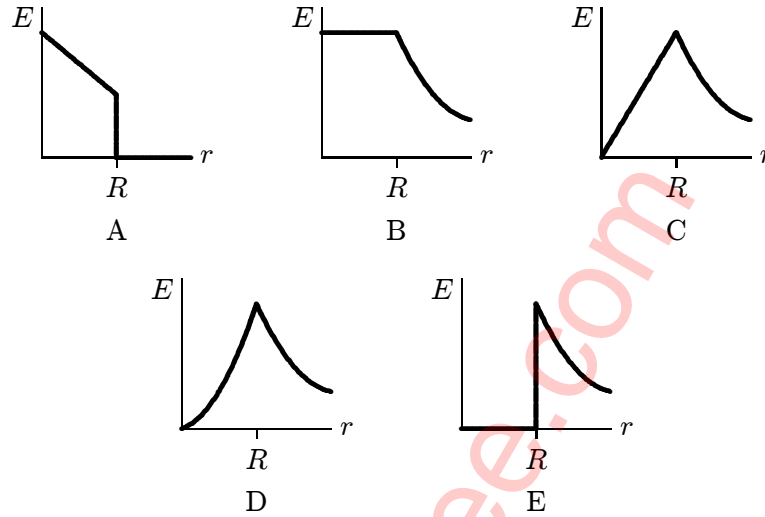

ans: E

23. Charge Q is distributed uniformly throughout an insulating sphere of radius R . The magnitude of the electric field at a point $R/2$ from the center is:

- A. $Q/4\pi\epsilon_0 R^2$
- B. $Q/\pi\epsilon_0 R^2$
- C. $3Q/4\pi\epsilon_0 R^2$
- D. $Q/8\pi\epsilon_0 R^2$
- E. none of these

ans: D

24. Positive charge Q is distributed uniformly throughout an insulating sphere of radius R , centered at the origin. A particle with positive charge Q is placed at $x = 2R$ on the x axis. The magnitude of the electric field at $x = R/2$ on the x axis is:

- A. $Q/4\pi\epsilon_0 R^2$
- B. $Q/8\pi\epsilon_0 R^2$
- C. $Q/72\pi\epsilon_0 R^2$
- D. $17Q/72\pi\epsilon_0 R^2$
- E. none of these

ans: C

25. Charge Q is distributed uniformly throughout a spherical insulating shell. The net electric flux in $\text{N} \cdot \text{m}^2 / \text{C}$ through the inner surface of the shell is:

- A. 0
- B. Q/ϵ_0
- C. $2Q/\epsilon_0$
- D. $Q/4\pi\epsilon_0$
- E. $Q/2\pi\epsilon_0$

ans: A

26. Charge Q is distributed uniformly throughout a spherical insulating shell. The net electric flux in $\text{N} \cdot \text{m}^2 / \text{C}$ through the outer surface of the shell is:
- A. 0
 - B. Q/ϵ_0
 - C. $2Q/\epsilon_0$
 - D. $Q/4\epsilon_0$
 - E. $Q/2\pi\epsilon_0$
- ans: B
27. A 3.5-cm radius hemisphere contains a total charge of $6.6 \times 10^{-7} \text{ C}$. The flux through the rounded portion of the surface is $9.8 \times 10^4 \text{ N} \cdot \text{m}^2 / \text{C}$. The flux through the flat base is:
- A. 0
 - B. $+2.3 \times 10^4 \text{ N} \cdot \text{m}^2 / \text{C}$
 - C. $-2.3 \times 10^4 \text{ N} \cdot \text{m}^2 / \text{C}$
 - D. $-9.8 \times 10^4 \text{ N} \cdot \text{m}^2 / \text{C}$
 - E. $+9.8 \times 10^4 \text{ N} \cdot \text{m}^2 / \text{C}$
- ans: C
28. Charge is distributed uniformly along a long straight wire. The electric field 2 cm from the wire is 20 N/C . The electric field 4 cm from the wire is:
- A. 120 N/C
 - B. 80 N/C
 - C. 40 N/C
 - D. 10 N/C
 - E. 5 N/C
- ans: D
29. Positive charge Q is placed on a conducting spherical shell with inner radius R_1 and outer radius R_2 . A particle with charge q is placed at the center of the cavity. The magnitude of the electric field at a point in the cavity, a distance r from the center, is:
- A. zero
 - B. $Q/4\pi\epsilon_0 R_1^2$
 - C. $q/4\pi\epsilon_0 r^2$
 - D. $(q + Q)/4\pi\epsilon_0 r^2$
 - E. $(q + Q)/4\pi\epsilon_0 (R_1^2 - r^2)$
- ans: C
30. Positive charge Q is placed on a conducting spherical shell with inner radius R_1 and outer radius R_2 . A point charge q is placed at the center of the cavity. The magnitude of the electric field at a point outside the shell, a distance r from the center, is:
- A. zero
 - B. $Q/4\pi\epsilon_0 r^2$
 - C. $q/4\pi\epsilon_0 r^2$
 - D. $(q + Q)/4\pi\epsilon_0 r^2$
 - E. $(q + Q)/4\pi\epsilon_0 (R_1^2 - r^2)$
- ans: D

31. Positive charge Q is placed on a conducting spherical shell with inner radius R_1 and outer radius R_2 . A point charge q is placed at the center of the cavity. The magnitude of the electric field produced by the charge on the inner surface at a point in the interior of the conductor, a distance r from the center, is:
- 0
 - $Q/4\pi\epsilon_0 R_1^2$
 - $Q/4\pi\epsilon_0 R_2^2$
 - $q/4\pi\epsilon_0 r^2$
 - $Q/4\pi\epsilon_0 r^2$

ans: D

32. A long line of charge with λ_ℓ charge per unit length runs along the cylindrical axis of a cylindrical shell which carries a charge per unit length of λ_c . The charge per unit length on the inner and outer surfaces of the shell, respectively are:
- λ_ℓ and λ_c
 - $-\lambda_\ell$ and $\lambda_c + \lambda_\ell$
 - $-\lambda_\ell$ and $\lambda_c - \lambda_c$
 - $\lambda_\ell + \lambda_c$ and $\lambda_c - \lambda_\ell$
 - $\lambda_\ell - \lambda_c$ and $\lambda_c + \lambda_\ell$

ans: B

33. Charge is distributed uniformly on the surface of a large flat plate. The electric field 2 cm from the plate is 30 N/C. The electric field 4 cm from the plate is:
- 120 N/C
 - 80 N/C
 - 30 N/C
 - 15 N/C
 - 7.5 N/C

ans: C

34. Two large insulating parallel plates carry charge of equal magnitude, one positive and the other negative, that is distributed uniformly over their inner surfaces. Rank the points 1 through 5 according to the magnitude of the electric field at the points, least to greatest.

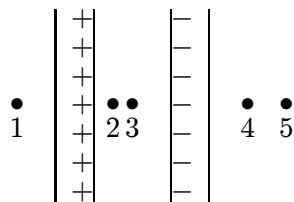

- 1, 2, 3, 4, 5
- 2, then 1, 3, and 4 tied, then 5
- 1, 4, and 5 tie, then 2 and 3 tie
- 2 and 3 tie, then 1 and 4 tie, then 5
- 2 and 3 tie, then 1, 4, and 5 tie

ans: C

35. Two large parallel plates carry positive charge of equal magnitude that is distributed uniformly over their inner surfaces. Rank the points 1 through 5 according to the magnitude of the electric field at the points, least to greatest.

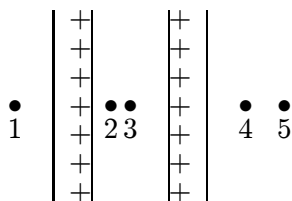

- A. 1, 2, 3, 4, 5
 B. 5, 4, 3, 2, 1
 C. 1, 4, and 5 tie, then 2 and 3 tie
 D. 2 and 3 tie, then 1 and 4 tie, then 5
 E. 2 and 3 tie, then 1, 4, and 5 tie
 ans: E
36. A particle with charge Q is placed outside a large neutral conducting sheet. At any point in the interior of the sheet the electric field produced by charges on the surface is directed:
 A. toward the surface
 B. away from the surface
 C. toward Q
 D. away from Q
 E. none of the above
 ans: C
37. A hollow conductor is positively charged. A small uncharged metal ball is lowered by a silk thread through a small opening in the top of the conductor and allowed to touch its inner surface. After the ball is removed, it will have:
 A. a positive charge
 B. a negative charge
 C. no appreciable charge
 D. a charge whose sign depends on what part of the inner surface it touched
 E. a charge whose sign depends on where the small hole is located in the conductor
 ans: C
38. A spherical conducting shell has charge Q . A particle with charge q is placed at the center of the cavity. The charge on the inner surface of the shell and the charge on the outer surface of the shell, respectively, are:
 A. 0, Q
 B. q , $Q - q$
 C. Q , 0
 D. $-q$, $Q + q$
 E. $-q$, 0
 ans: D

Chapter 24: ELECTRIC POTENTIAL

1. An electron moves from point i to point f , in the direction of a uniform electric field. During this displacement:

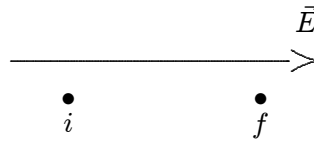

- A. the work done by the field is positive and the potential energy of the electron-field system increases
B. the work done by the field is negative and the potential energy of the electron-field system increases
C. the work done by the field is positive and the potential energy of the electron-field system decreases
D. the work done by the field is negative and the potential energy of the electron-field system decreases
E. the work done by the field is positive and the potential energy of the electron-field system does not change
ans: B
2. A particle with a charge of $5.5 \times 10^{-8} \text{ C}$ is 3.5 cm from a particle with a charge of $-2.3 \times 10^{-8} \text{ C}$. The potential energy of this two-particle system, relative to the potential energy at infinite separation, is:
A. $3.2 \times 10^{-4} \text{ J}$
B. $-3.2 \times 10^{-4} \text{ J}$
C. $9.3 \times 10^{-3} \text{ J}$
D. $-9.3 \times 10^{-3} \text{ J}$
E. zero
ans: B
3. A particle with a charge of $5.5 \times 10^{-8} \text{ C}$ is fixed at the origin. A particle with a charge of $-2.3 \times 10^{-8} \text{ C}$ is moved from $x = 3.5 \text{ cm}$ on the x axis to $y = 4.3 \text{ cm}$ on the y axis. The change in potential energy of the two-particle system is:
A. $3.1 \times 10^{-3} \text{ J}$
B. $-3.1 \times 10^{-3} \text{ J}$
C. $6.0 \times 10^{-5} \text{ J}$
D. $-6.0 \times 10^{-5} \text{ J}$
E. 0
ans: C

4. A particle with a charge of 5.5×10^{-8} C charge is fixed at the origin. A particle with a charge of -2.3×10^{-8} C charge is moved from $x = 3.5$ cm on the x axis to $y = 3.5$ cm on the y axis. The change in the potential energy of the two-particle system is:
- A. 3.2×10^{-4} J
 - B. -3.2×10^{-4} J
 - C. 9.3×10^{-3} J
 - D. -9.3×10^{-3} J
 - E. 0

ans: E

5. Three particles lie on the x axis: particle 1, with a charge of 1×10^{-8} C is at $x = 1$ cm, particle 2, with a charge of 2×10^{-8} C, is at $x = 2$ cm, and particle 3, with a charge of -3×10^{-8} C, is at $x = 3$ cm. The potential energy of this arrangement, relative to the potential energy for infinite separation, is:
- A. $+4.9 \times 10^{-4}$ J
 - B. -4.9×10^{-4} J
 - C. $+8.5 \times 10^{-4}$ J
 - D. -8.5×10^{-4} J
 - E. zero

ans: B

6. Two identical particles, each with charge q , are placed on the x axis, one at the origin and the other at $x = 5$ cm. A third particle, with charge $-q$, is placed on the x axis so the potential energy of the three-particle system is the same as the potential energy at infinite separation. Its x coordinate is:
- A. 13 cm
 - B. 2.5 cm
 - C. 7.5 cm
 - D. 10 cm
 - E. -5 cm

ans: A

7. Choose the correct statement:
- A. A proton tends to go from a region of low potential to a region of high potential
 - B. The potential of a negatively charged conductor must be negative
 - C. If $\vec{E} = 0$ at a point P then V must be zero at P
 - D. If $V = 0$ at a point P then \vec{E} must be zero at P
 - E. None of the above are correct

ans: E

8. If 500 J of work are required to carry a charged particle between two points with a potential difference of 20 V, the magnitude of the charge on the particle is:
- A. 0.040 C
 - B. 12.5 C
 - C. 20 C
 - D. cannot be computed unless the path is given
 - E. none of these

ans: B

9. The potential difference between two points is 100 V. If a particle with a charge of 2 C is transported from one of these points to the other, the magnitude of the work done is:
- 200 J
 - 100 J
 - 50 J
 - 100 J
 - 2 J

ans: A

10. During a lightning discharge, 30 C of charge move through a potential difference of 1.0×10^8 V in 2.0×10^{-2} s. The energy released by this lightning bolt is:
- 1.5×10^{11} J
 - 3.0×10^9 J
 - 6.0×10^7 J
 - 3.3×10^6 J
 - 1500 J

ans: B

11. Points R and T are each a distance d from each of two particles with charges of equal magnitudes and opposite signs as shown. If $k = 1/4\pi\epsilon_0$, the work required to move a particle with a negative charge q from R to T is:

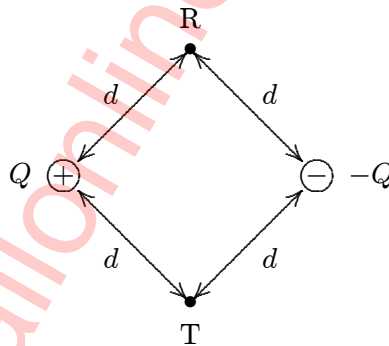

- 0
- kqQ/d^2
- kqQ/d
- $kqQ/(\sqrt{2}d)$
- $kQq/(2d)$

ans: A

12. Points R and T are each a distance d from each of two particles with equal positive charges as shown. If $k = 1/4\pi\epsilon_0$, the work required to move a particle with charge q from R to T is:

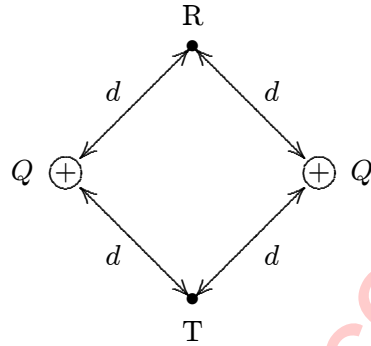

- A. 0
 B. kQq/d^2
 C. kQq/d
 D. $kQq/(\sqrt{2}d)$
 E. $kQq/(2d)$

ans: A

13. Two particles with charges Q and $-Q$ are fixed at the vertices of an equilateral triangle with sides of length a . If $k = 1/4\pi\epsilon_0$, the work required to move a particle with charge q from the other vertex to the center of the line joining the fixed particles is:

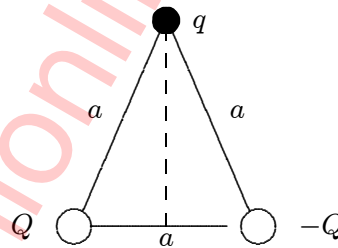

- A. 0
 B. kQq/a
 C. kQq/a^2
 D. $2kQq/a$
 E. $\sqrt{2}kQq/a$

ans: A

14. A particle with mass m and charge $-q$ is projected with speed v_0 into the region between two parallel plates as shown. The potential difference between the two plates is V and their separation is d . The change in kinetic energy of the particle as it traverses this region is:

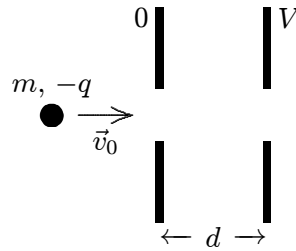

- A. $-qV/d$
 B. $2qV/mv_0^2$
 C. qV
 D. $mv_0^2/2$
 E. none of these

ans: C

15. An electron is accelerated from rest through a potential difference V . Its final speed is proportional to:

- A. V
 B. V^2
 C. \sqrt{V}
 D. $1/V$
 E. $1/\sqrt{V}$

ans: C

16. In separate experiments, four different particles each start from far away with the same speed and impinge directly on a gold nucleus. The masses and charges of the particles are

- particle 1: mass m_0 , charge q_0
 particle 2: mass $2m_0$, charge $2q_0$
 particle 3: mass $2m_0$, charge $q_0/2$
 particle 4: mass $m_0/2$, charge $2q_0$

Rank the particles according to the distance of closest approach to the gold nucleus, from smallest to largest.

- A. 1, 2, 3, 4
 B. 4, 3, 2, 1
 C. 3, 1 and 2 tie, then 4
 D. 4, 1 and 2 tie, then 1
 E. 1 and 2 tie, then 3, 4

ans: C

17. Two large parallel conducting plates are separated by a distance d , placed in a vacuum, and connected to a source of potential difference V . An oxygen ion, with charge $2e$, starts from rest on the surface of one plate and accelerates to the other. If e denotes the magnitude of the electron charge, the final kinetic energy of this ion is:
- $eV/2$
 - eV/d
 - eVd
 - Vd/e
 - $2eV$

ans: E

18. An electron volt is :
- the force acting on an electron in a field of 1 N/C
 - the force required to move an electron 1 meter
 - the energy gained by an electron in moving through a potential difference of 1 volt
 - the energy needed to move an electron through 1 meter in any electric field
 - the work done when 1 coulomb of charge is moved through a potential difference of 1 volt.

ans: C

19. An electron has charge $-e$ and mass m_e . A proton has charge e and mass $1840m_e$. A “proton volt” is equal to:
- 1 eV
 - 1840 eV
 - $(1/1840)\text{ eV}$
 - $\sqrt{1840}\text{ eV}$
 - $(1/\sqrt{1840})\text{ eV}$

ans: A

20. Two conducting spheres, one having twice the diameter of the other, are separated by a distance large compared to their diameters. The smaller sphere (1) has charge q and the larger sphere (2) is uncharged. If the spheres are then connected by a long thin wire:



- 1 and 2 have the same potential
- 2 has twice the potential of 1
- 2 has half the potential of 1
- 1 and 2 have the same charge
- all of the charge is dissipated

ans: A

21. Two conducting spheres are far apart. The smaller sphere carries a total charge Q . The larger sphere has a radius that is twice that of the smaller and is neutral. After the two spheres are connected by a conducting wire, the charges on the smaller and larger spheres, respectively, are:
- $Q/2$ and $Q/2$
 - $Q/3$ and $2Q/3$
 - $2Q/3$ and $Q/3$
 - zero and Q
 - $2Q$ and $-Q$

ans: B

22. Three possible configurations for an electron e and a proton p are shown below. Take the zero of potential to be at infinity and rank the three configurations according to the potential at S , from most negative to most positive.

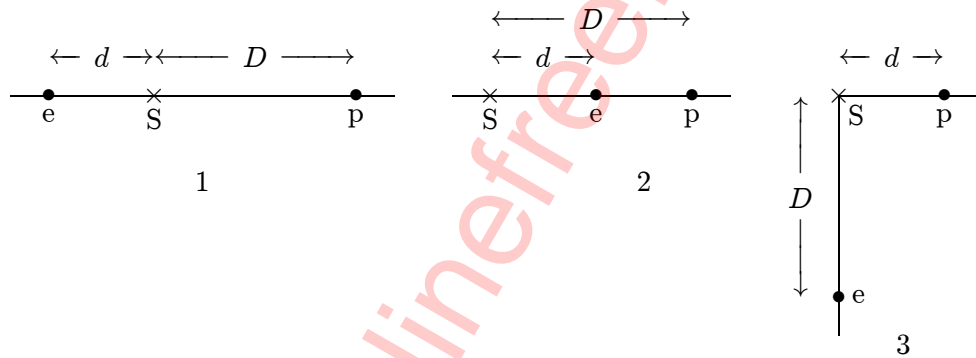

- 1, 2, 3
- 3, 2, 1
- 2, 3, 1
- 1 and 2 tie, then 3
- 1 and 3 tie, then 2

ans: D

23. A conducting sphere with radius R is charged until the magnitude of the electric field just outside its surface is E . The electric potential of the sphere, relative to the potential far away, is:

- zero
- E/R
- E/R^2
- ER
- ER^2

ans: D

24. A 5-cm radius conducting sphere has a surface charge density of $2 \times 10^{-6} \text{ C/m}^2$ on its surface. Its electric potential, relative to the potential far away, is:
- A. $1.1 \times 10^4 \text{ V}$
 - B. $2.2 \times 10^4 \text{ V}$
 - C. $2.3 \times 10^5 \text{ V}$
 - D. $3.6 \times 10^5 \text{ V}$
 - E. $7.2 \times 10^6 \text{ V}$
- ans: A
25. A hollow metal sphere is charged to a potential V . The potential at its center is:
- A. V
 - B. 0
 - C. $-V$
 - D. $2V$
 - E. πV
- ans: A
26. Positive charge is distributed uniformly throughout a non-conducting sphere. The highest electric potential occurs:
- A. at the center
 - B. at the surface
 - C. halfway between the center and surface
 - D. just outside the surface
 - E. far from the sphere
- ans: A
27. A total charge of $7 \times 10^{-8} \text{ C}$ is uniformly distributed throughout a non-conducting sphere with a radius of 5 cm. The electric potential at the surface, relative to the potential far away, is about:
- A. $-1.3 \times 10^4 \text{ V}$
 - B. $1.3 \times 10^4 \text{ V}$
 - C. $7.0 \times 10^5 \text{ V}$
 - D. $-6.3 \times 10^4 \text{ V}$
 - E. 0
- ans: B
28. Eight identical spherical raindrops are each at a potential V , relative to the potential far away. They coalesce to make one spherical raindrop whose potential is:
- A. $V/8$
 - B. $V/2$
 - C. $2V$
 - D. $4V$
 - E. $8V$
- ans: D

29. A metal sphere carries a charge of 5×10^{-9} C and is at a potential of 400 V, relative to the potential far away. The potential at the center of the sphere is:
- A. 400 V
 - B. -400 V
 - C. 2×10^{-6} V
 - D. 0
 - E. none of these
- ans: A
30. A 5-cm radius isolated conducting sphere is charged so its potential is +100 V, relative to the potential far away. The charge density on its surface is:
- A. $+2.2 \times 10^{-7}$ C/m²
 - B. -2.2×10^{-7} C/m²
 - C. $+3.5 \times 10^{-7}$ C/m²
 - D. -3.5×10^{-7} C/m²
 - E. $+1.8 \times 10^{-8}$ C/m²
- ans: E
31. A conducting sphere has charge Q and its electric potential is V , relative to the potential far away. If the charge is doubled to $2Q$, the potential is:
- A. V
 - B. $2V$
 - C. $4V$
 - D. $V/2$
 - E. $V/4$
- ans: B
32. The potential difference between the ends of a 2-meter stick that is parallel to a uniform electric field is 400 V. The magnitude of the electric field is:
- A. zero
 - B. 100 V/m
 - C. 200 V/m
 - D. 400 V/m
 - E. 800 V/m
- ans: E
33. In a certain region of space the electric potential increases uniformly from east to west and does not vary in any other direction. The electric field:
- A. points east and varies with position
 - B. points east and does not vary with position
 - C. points west and varies with position
 - D. points west and does not vary with position
 - E. points north and does not vary with position
- ans: B

34. If the electric field is in the positive x direction and has a magnitude given by $E = Cx^2$, where C is a constant, then the electric potential is given by $V =$:
- $2Cx$
 - $-2Cx$
 - $Cx^3/3$
 - $-Cx^3/3$
 - $-3Cx^3$
- ans: D

35. An electron goes from one equipotential surface to another along one of the four paths shown below. Rank the paths according to the work done by the electric field, from least to greatest.

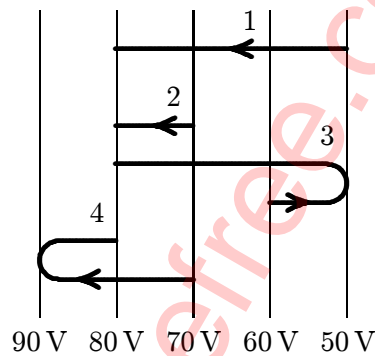

- 1, 2, 3, 4
 - 4, 3, 2, 1
 - 1, 3, 4 and 2 tie
 - 4 and 2 tie, then 3, then 1
 - 4, 3, 1, 2
- ans: D
36. The work required to carry a particle with a charge of 6.0 C from a 5.0-V equipotential surface to a 6.0-V equipotential surface and back again to the 5.0-V surface is:
- 0
 - $1.2 \times 10^{-5}\text{ J}$
 - $3.0 \times 10^{-5}\text{ J}$
 - $6.0 \times 10^{-5}\text{ J}$
 - $6.0 \times 10^{-6}\text{ J}$
- ans: A
37. The equipotential surfaces associated with a charged point particles are:
- radially outward from the particle
 - vertical planes
 - horizontal planes
 - concentric spheres centered at the particle
 - concentric cylinders with the particle on the axis.
- ans: D

38. The electric field in a region around the origin is given by $\vec{E} = C(x\hat{i} + y\hat{j})$, where C is a constant. The equipotential surfaces in that region are:
- concentric cylinders with axes along the z axis
 - concentric cylinders with axes along the x axis
 - concentric spheres centered at the origin
 - planes parallel to the xy plane
 - planes parallel to the yz plane

ans: A

39. The electric potential in a certain region of space is given by $V = -7.5x^2 + 3x$, where V is in volts and x is in meters. In this region the equipotential surfaces are:
- planes parallel to the x axis
 - planes parallel to the yz plane
 - concentric spheres centered at the origin
 - concentric cylinders with the x axis as the cylinder axis
 - unknown unless the charge is given

ans: B

40. In the diagram, the points 1, 2, and 3 are all the same very large distance from a dipole. Rank the points according to the values of the electric potential at them, from the most negative to the most positive.

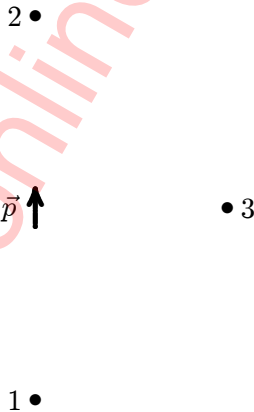

- 1, 2, 3
- 3, 2, 1
- 2, 3, 1
- 1, 3, 2
- 1 and 2 tie, then 3

ans: D

41. A particle with charge q is to be brought from far away to a point near an electric dipole. No work is done if the final position of the particle is on:
- the line through the charges of the dipole
 - a line that is perpendicular to the dipole moment
 - a line that makes an angle of 45° with the dipole moment
 - a line that makes an angle of 30° with the dipole moment
 - none of the above

ans: B

42. Equipotential surfaces associated with an electric dipole are:
- spheres centered on the dipole
 - cylinders with axes along the dipole moment
 - planes perpendicular to the dipole moment
 - planes parallel to the dipole moment
 - none of the above

ans: E

43. The diagram shows four pairs of large parallel conducting plates. The value of the electric potential is given for each plate. Rank the pairs according to the magnitude of the electric field between the plates, least to greatest.

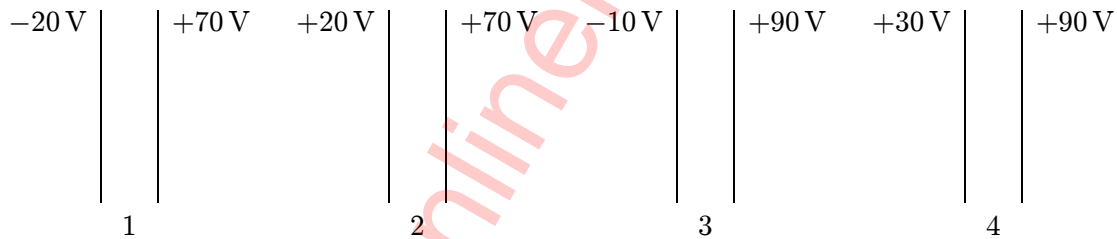

- 1, 2, 3, 4
- 4, 3, 2, 1
- 2, 3, 1, 4
- 2, 4, 1, 3
- 3, 2, 4, 1

ans: D

Chapter 25: CAPACITANCE

- The units of capacitance are equivalent to:
 - J/C
 - V/C
 - J^2/C
 - C/J
 - C^2/Jans: E
- A farad is the same as a:
 - J/V
 - V/J
 - C/V
 - V/C
 - N/Cans: C
- A capacitor C “has a charge Q”. The actual charges on its plates are:
 - Q, Q
 - $Q/2, Q/2$
 - Q, $-Q$
 - $Q/2, -Q/2$
 - Q, 0ans: C
- Each plate of a capacitor stores a charge of magnitude 1 mC when a 100-V potential difference is applied. The capacitance is:
 - $5 \mu\text{F}$
 - $10 \mu\text{F}$
 - $50 \mu\text{F}$
 - $100 \mu\text{F}$
 - none of theseans: B
- To charge a 1-F capacitor with 2 C requires a potential difference of:
 - 2 V
 - 0.2 V
 - 5 V
 - 0.5 V
 - none of theseans: A

6. The capacitance of a parallel-plate capacitor with plate area A and plate separation d is given by:
- A. $\epsilon_0 d/A$
 - B. $\epsilon_0 d/2A$
 - C. $\epsilon_0 A/d$
 - D. $\epsilon_0 A/2d$
 - E. Ad/ϵ_0
- ans: C

7. The capacitance of a parallel-plate capacitor is:
- A. proportional to the plate area
 - B. proportional to the charge stored
 - C. independent of any material inserted between the plates
 - D. proportional to the potential difference of the plates
 - E. proportional to the plate separation
- ans: A

8. The plate areas and plate separations of five parallel plate capacitors are
- capacitor 1: area A_0 , separation d_0
 - capacitor 2: area $2A_0$, separation $2d_0$
 - capacitor 3: area $2A_0$, separation $d_0/2$
 - capacitor 4: area $A_0/2$, separation $2d_0$
 - capacitor 5: area A_0 , separation $d_0/2$
- Rank these according to their capacitances, least to greatest.
- A. 1, 2, 3, 4, 5
 - B. 5, 4, 3, 2, 1
 - C. 5, 3 and 4 tie, then 1, 2
 - D. 4, 1 and 2 tie, then 5, 3
 - E. 3, 5, 1 and 2 tie, 1, 4
- ans: D

9. The capacitance of a parallel-plate capacitor can be increased by:
- A. increasing the charge
 - B. decreasing the charge
 - C. increasing the plate separation
 - D. decreasing the plate separation
 - E. decreasing the plate area
- ans: D

10. If both the plate area and the plate separation of a parallel-plate capacitor are doubled, the capacitance is:
- A. doubled
 - B. halved
 - C. unchanged
 - D. tripled
 - E. quadrupled
- ans: C

11. If the plate area of an isolated charged parallel-plate capacitor is doubled:
- A. the electric field is doubled
 - B. the potential difference is halved
 - C. the charge on each plate is halved
 - D. the surface charge density on each plate is doubled
 - E. none of the above
- ans: B
12. If the plate separation of an isolated charged parallel-plate capacitor is doubled:
- A. the electric field is doubled
 - B. the potential difference is halved
 - C. the charge on each plate is halved
 - D. the surface charge density on each plate is doubled
 - E. none of the above
- ans: E
13. Pulling the plates of an isolated charged capacitor apart:
- A. increases the capacitance
 - B. increases the potential difference
 - C. does not affect the potential difference
 - D. decreases the potential difference
 - E. does not affect the capacitance
- ans: B
14. If the charge on a parallel-plate capacitor is doubled:
- A. the capacitance is halved
 - B. the capacitance is doubled
 - C. the electric field is halved
 - D. the electric field is doubled
 - E. the surface charge density is not changed on either plate
- ans: D
15. A parallel-plate capacitor has a plate area of 0.2 m^2 and a plate separation of 0.1 mm . To obtain an electric field of $2.0 \times 10^6\text{ V/m}$ between the plates, the magnitude of the charge on each plate should be:
- A. $8.9 \times 10^{-7}\text{ C}$
 - B. $1.8 \times 10^{-6}\text{ C}$
 - C. $3.5 \times 10^{-6}\text{ C}$
 - D. $7.1 \times 10^{-6}\text{ C}$
 - E. $1.4 \times 10^{-5}\text{ C}$
- ans: D

16. A parallel-plate capacitor has a plate area of 0.2 m^2 and a plate separation of 0.1 mm . If the charge on each plate has a magnitude of $4 \times 10^{-6} \text{ C}$ the potential difference across the plates is approximately:
- A. 0
 - B. $4 \times 10^{-2} \text{ V}$
 - C. $1 \times 10^2 \text{ V}$
 - D. $2 \times 10^2 \text{ V}$
 - E. $4 \times 10^8 \text{ V}$
- ans: D
17. The capacitance of a spherical capacitor with inner radius a and outer radius b is proportional to:
- A. a/b
 - B. $b - a$
 - C. $b^2 - a^2$
 - D. $ab/(b - a)$
 - E. $ab/(b^2 - a^2)$
- ans: D
18. The capacitance of a single isolated spherical conductor with radius R is proportional to:
- A. R
 - B. R^2
 - C. $1/R$
 - D. $1/R^2$
 - E. none of these
- ans: A
19. Two conducting spheres have radii of R_1 and R_2 , with R_1 greater than R_2 . If they are far apart the capacitance is proportional to:
- A. $R_1 R_2 / (R_1 - R_2)$
 - B. $R_1^2 - R_2^2$
 - C. $(R_1 - R_2) / R_1 R_2$
 - D. $R_1^2 + R_2^2$
 - E. none of these
- ans: A
20. The capacitance of a cylindrical capacitor can be increased by:
- A. decreasing both the radius of the inner cylinder and the length
 - B. increasing both the radius of the inner cylinder and the length
 - C. increasing the radius of the outer cylindrical shell and decreasing the length
 - D. decreasing the radius of the inner cylinder and increasing the radius of the outer cylindrical shell
 - E. only by decreasing the length
- ans: B

21. A battery is used to charge a series combination of two identical capacitors. If the potential difference across the battery terminals is V and total charge Q flows through the battery during the charging process then the charge on the positive plate of each capacitor and the potential difference across each capacitor are:
- A. $Q/2$ and $V/2$, respectively
 - B. Q and V , respectively
 - C. $Q/2$ and V , respectively
 - D. Q and $V/2$, respectively
 - E. Q and $2V$, respectively
- ans: D
22. A battery is used to charge a parallel combination of two identical capacitors. If the potential difference across the battery terminals is V and total charge Q flows through the battery during the charging process then the charge on the positive plate of each capacitor and the potential difference across each capacitor are:
- A. $Q/2$ and $V/2$, respectively
 - B. Q and V , respectively
 - C. $Q/2$ and V , respectively
 - D. Q and $V/2$, respectively
 - E. Q and $2V$, respectively
- ans: C
23. A $2\text{-}\mu\text{F}$ and a $1\text{-}\mu\text{F}$ capacitor are connected in series and a potential difference is applied across the combination. The $2\text{-}\mu\text{F}$ capacitor has:
- A. twice the charge of the $1\text{-}\mu\text{F}$ capacitor
 - B. half the charge of the $1\text{-}\mu\text{F}$ capacitor
 - C. twice the potential difference of the $1\text{-}\mu\text{F}$ capacitor
 - D. half the potential difference of the $1\text{-}\mu\text{F}$ capacitor
 - E. none of the above
- ans: D
24. A $2\text{-}\mu\text{F}$ and a $1\text{-}\mu\text{F}$ capacitor are connected in parallel and a potential difference is applied across the combination. The $2\text{-}\mu\text{F}$ capacitor has:
- A. twice the charge of the $1\text{-}\mu\text{F}$ capacitor
 - B. half the charge of the $1\text{-}\mu\text{F}$ capacitor
 - C. twice the potential difference of the $1\text{-}\mu\text{F}$ capacitor
 - D. half the potential difference of the $1\text{-}\mu\text{F}$ capacitor
 - E. none of the above
- ans: A
25. Let Q denote charge, V denote potential difference, and U denote stored energy. Of these quantities, capacitors in series must have the same:
- A. Q only
 - B. V only
 - C. U only
 - D. Q and U only
 - E. V and U only
- ans: A

26. Let Q denote charge, V denote potential difference, and U denote stored energy. Of these quantities, capacitors in parallel must have the same:
- A. Q only
 - B. V only
 - C. U only
 - D. Q and U only
 - E. V and U only
- ans: B
27. Capacitors C_1 and C_2 are connected in parallel. The equivalent capacitance is given by:
- A. $C_1 C_2 / (C_1 + C_2)$
 - B. $(C_1 + C_2) / C_1 C_2$
 - C. $1 / (C_1 + C_2)$
 - D. C_1 / C_2
 - E. $C_1 + C_2$
- ans: E
28. Capacitors C_1 and C_2 are connected in series. The equivalent capacitance is given by:
- A. $C_1 C_2 / (C_1 + C_2)$
 - B. $(C_1 + C_2) / C_1 C_2$
 - C. $1 / (C_1 + C_2)$
 - D. C_1 / C_2
 - E. $C_1 + C_2$
- ans: A
29. Capacitors C_1 and C_2 are connected in series and a potential difference is applied to the combination. If the capacitor that is equivalent to the combination has the same potential difference, then the charge on the equivalent capacitor is the same as:
- A. the charge on C_1
 - B. the sum of the charges on C_1 and C_2
 - C. the difference of the charges on C_1 and C_2
 - D. the product of the charges on C_1 and C_2
 - E. none of the above
- ans: A
30. Capacitors C_1 and C_2 are connected in parallel and a potential difference is applied to the combination. If the capacitor that is equivalent to the combination has the same potential difference, then the charge on the equivalent capacitor is the same as:
- A. the charge on C_1
 - B. the sum of the charges on C_1 and C_2
 - C. the difference of the charges on C_1 and C_2
 - D. the product of the charges on C_1 and C_2
 - E. none of the above
- ans: B

31. Two identical capacitors are connected in series and two, each identical to the first, are connected in parallel. The equivalent capacitance of the series connection is _____ the equivalent capacitance of parallel connection.
- twice
 - four times
 - half
 - one-fourth
 - the same as
- ans: D

32. Two identical capacitors, each with capacitance C , are connected in parallel and the combination is connected in series to a third identical capacitor. The equivalent capacitance of this arrangement is:
- $2C/3$
 - C
 - $3C/2$
 - $2C$
 - $3C$
- ans: A

33. A $2\text{-}\mu\text{F}$ and a $1\text{-}\mu\text{F}$ capacitor are connected in series and charged from a battery. They store charges P and Q , respectively. When disconnected and charged separately using the same battery, they have charges R and S , respectively. Then:
- $R > S > Q = P$
 - $P > Q > R = S$
 - $R > P = Q > S$
 - $R = P > S = Q$
 - $R > P > S = Q$
- ans: A

34. Capacitor C_1 is connected alone to a battery and charged until the magnitude of the charge on each plate is $4.0 \times 10^{-8} \text{ C}$. Then it is removed from the battery and connected to two other capacitors C_2 and C_3 , as shown. The charge on the positive plate of C_1 is then $1.0 \times 10^{-8} \text{ C}$. The charges on the positive plates of C_2 and C_3 are:

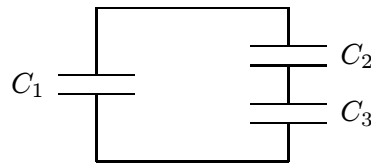

- $q_2 = 3.0 \times 10^{-8} \text{ C}$ and $q_3 = 3.0 \times 10^{-8} \text{ C}$
 - $q_2 = 2.0 \times 10^{-8} \text{ C}$ and $q_3 = 2.0 \times 10^{-8} \text{ C}$
 - $q_2 = 5.0 \times 10^{-8} \text{ C}$ and $q_3 = 1.0 \times 10^{-8} \text{ C}$
 - $q_2 = 3.0 \times 10^{-8} \text{ C}$ and $q_3 = 1.0 \times 10^{-8} \text{ C}$
 - $q_2 = 1.0 \times 10^{-8} \text{ C}$ and $q_3 = 3.0 \times 10^{-8} \text{ C}$
- ans: A

35. Each of the four capacitors shown is $500\ \mu\text{F}$. The voltmeter reads $1000\ \text{V}$. The magnitude of the charge, in coulombs, on each capacitor plate is:

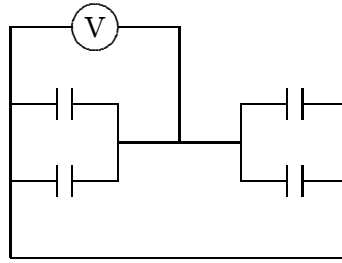

- A. 0.2
 B. 0.5
 C. 20
 D. 50
 E. none of these

ans: B

36. The diagram shows four $6\text{-}\mu\text{F}$ capacitors. The capacitance between points a and b is:

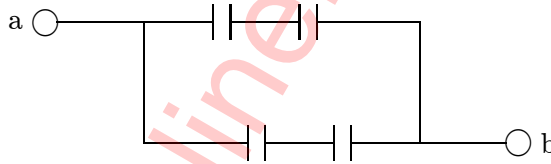

- A. $3\ \mu\text{F}$
 B. $4\ \mu\text{F}$
 C. $6\ \mu\text{F}$
 D. $9\ \mu\text{F}$
 E. $1\ \mu\text{F}$

ans: C

37. Each of the two $25\text{-}\mu\text{F}$ capacitors shown is initially uncharged. How many coulombs of charge pass through the ammeter A after the switch S is closed?

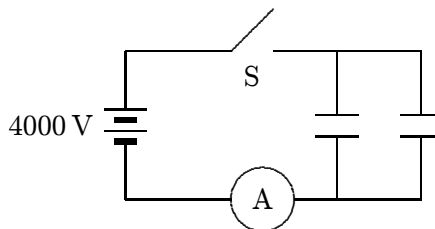

- A. 0.10
 B. 0.20
 C. 10
 D. 0.05
 E. none of these

ans: B

38. A 20-F capacitor is charged to 200 V. Its stored energy is:
- A. 4000 J
 - B. 4 J
 - C. 0.4 J
 - D. 2000 J
 - E. 0.1 J
- ans: C
39. A charged capacitor stores 10 C at 40 V. Its stored energy is:
- A. 400 J
 - B. 4 J
 - C. 0.2 J
 - D. 2.5 J
 - E. 200 J
- ans: E
40. A $2\text{-}\mu\text{F}$ and a $1\text{-}\mu\text{F}$ capacitor are connected in series and charged by a battery. They store energies P and Q , respectively. When disconnected and charged separately using the same battery, they store energies R and S , respectively. Then:
- A. $R > P > S > Q$
 - B. $P > Q > R > S$
 - C. $R > P > Q > S$
 - D. $P > R > S > Q$
 - E. $R > S > Q > P$
- ans: E
41. The quantity $(1/2)\epsilon_0 E^2$ has the significance of:
- A. energy/farad
 - B. energy/coulomb
 - C. energy
 - D. energy/volume
 - E. energy/volt
- ans: D
42. Capacitors A and B are identical. Capacitor A is charged so it stores 4 J of energy and capacitor B is uncharged. The capacitors are then connected in parallel. The total stored energy in the capacitors is now:
- A. 16 J
 - B. 8 J
 - C. 4 J
 - D. 2 J
 - E. 1 J
- ans: D

43. To store a total of 0.040 J of energy in the two identical capacitors shown, each should have a capacitance of:

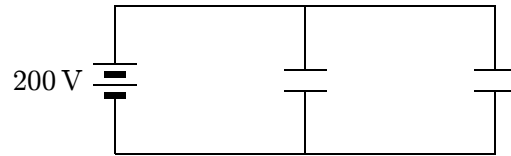

- A. $0.10 \mu\text{F}$
 B. $0.50 \mu\text{F}$
 C. $1.0 \mu\text{F}$
 D. $1.5 \mu\text{F}$
 E. $2.0 \mu\text{F}$
 ans: C
44. A battery is used to charge a parallel-plate capacitor, after which it is disconnected. Then the plates are pulled apart to twice their original separation. This process will double the:
- A. capacitance
 B. surface charge density on each plate
 C. stored energy
 D. electric field between the two plates
 E. charge on each plate
 ans: C
45. A parallel-plate capacitor has a plate area of 0.3 m^2 and a plate separation of 0.1 mm . If the charge on each plate has a magnitude of $5 \times 10^{-6} \text{ C}$ then the force exerted by one plate on the other has a magnitude of about:
- A. 0
 B. 5 N
 C. 9 N
 D. $1 \times 10^4 \text{ N}$
 E. $9 \times 10^5 \text{ N}$
 ans: B
46. A certain capacitor has a capacitance of $5.0 \mu\text{F}$. After it is charged to $5.0 \mu\text{C}$ and isolated, the plates are brought closer together so its capacitance becomes $10 \mu\text{F}$. The work done by the agent is about:
- A. zero
 B. $1.25 \times 10^{-6} \text{ J}$
 C. $-1.25 \times 10^{-6} \text{ J}$
 D. $8.3 \times 10^{-7} \text{ J}$
 E. $-8.3 \times 10^{-7} \text{ J}$
 ans: C

47. A dielectric slab is slowly inserted between the plates of a parallel plate capacitor, while the potential difference between the plates is held constant by a battery. As it is being inserted:
- A. the capacitance, the potential difference between the plates, and the charge on the positive plate all increase
 - B. the capacitance, the potential difference between the plates, and the charge on the positive plate all decrease
 - C. the potential difference between the plates increases, the charge on the positive plate decreases, and the capacitance remains the same
 - D. the capacitance and the charge on the positive plate decrease but the potential difference between the plates remains the same
 - E. the capacitance and the charge on the positive plate increase but the potential difference between the plates remains the same
- ans: E
48. An air-filled parallel-plate capacitor has a capacitance of 1 pF. The plate separation is then doubled and a wax dielectric is inserted, completely filling the space between the plates. As a result, the capacitance becomes 2 pF. The dielectric constant of the wax is:
- A. 0.25
 - B. 0.5
 - C. 2.0
 - D. 4.0
 - E. 8.0
- ans: D
49. One of materials listed below is to be placed between two identical metal sheets, with no, air gap, to form a parallel-plate capacitor. Which produces the greatest capacitance?
- A. material of thickness 0.1 mm and dielectric constant 2
 - B. material of thickness 0.2 mm and dielectric constant 3
 - C. material of thickness 0.3 mm and dielectric constant 2
 - D. material of thickness 0.4 mm and dielectric constant 8
 - E. material of thickness 0.5 mm and dielectric constant 11
- ans: E
50. Two capacitors are identical except that one is filled with air and the other with oil. Both capacitors carry the same charge. The ratio of the electric fields $E_{\text{air}}/E_{\text{oil}}$ is:
- A. between 0 and 1
 - B. 0
 - C. 1
 - D. between 1 and infinity
 - E. infinite
- ans: D

51. A parallel-plate capacitor, with air dielectric, is charged by a battery, after which the battery is disconnected. A slab of glass dielectric is then slowly inserted between the plates. As it is being inserted:
- A. a force repels the glass out of the capacitor
 - B. a force attracts the glass into the capacitor
 - C. no force acts on the glass
 - D. a net charge appears on the glass
 - E. the glass makes the plates repel each other
- ans: B
52. Two parallel-plate capacitors with the same plate separation but different capacitance are connected in parallel to a battery. Both capacitors are filled with air. The quantity that is NOT the same for both capacitors when they are fully charged is:
- A. potential difference
 - B. energy density
 - C. electric field between the plates
 - D. charge on the positive plate
 - E. dielectric constant
- ans: D
53. Two parallel-plate capacitors with the same plate area but different capacitance are connected in parallel to a battery. Both capacitors are filled with air. The quantity that is the same for both capacitors when they are fully charged is:
- A. potential difference
 - B. energy density
 - C. electric field between the plates
 - D. charge on the positive plate
 - E. plate separation
- ans: A
54. Two parallel-plate capacitors with different plate separation but the same capacitance are connected in series to a battery. Both capacitors are filled with air. The quantity that is NOT the same for both capacitors when they are fully charged is:
- A. potential difference
 - B. stored energy
 - C. electric field between the plates
 - D. charge on the positive plate
 - E. dielectric constant
- ans: C
55. Two parallel-plate capacitors with different capacitance but the same plate separation are connected in series to a battery. Both capacitors are filled with air. The quantity that is the same for both capacitors when they are fully charged is:
- A. potential difference
 - B. stored energy
 - C. energy density
 - D. electric field between the plates
 - E. charge on the positive plate
- ans: E

Chapter 26: CURRENT AND RESISTANCE

1. A car battery is rated at $80 \text{ A} \cdot \text{h}$. An ampere-hour is a unit of:

- A. power
- B. energy
- C. current
- D. charge
- E. force

ans: D

2. Current has units:

- A. kilowatt·hour
- B. coulomb/second
- C. coulomb
- D. volt
- E. ohm

ans: B

3. Current has units:

- A. kilowatt·hour
- B. ampere
- C. coulomb
- D. volt
- E. ohm

ans: B

4. The units of resistivity are:

- A. ohm
- B. ohm·meter
- C. ohm/meter
- D. ohm/meter²
- E. none of these

ans: B

5. The rate at which electrical energy is used may be measured in:

- A. watt/second
- B. watt·second
- C. watt
- D. joule·second
- E. kilowatt·hour

ans: C

6. Energy may be measured in:

- A. kilowatt
- B. joule·second
- C. watt
- D. watt·second
- E. volt/ohm

ans: D

7. Which one of the following quantities is correctly matched to its unit?

- A. Power — kW·h
- B. Energy — kW
- C. Potential difference — J/C
- D. Current — A/s
- E. Resistance — V/C

ans: C

8. Current is a measure of:

- A. force that moves a charge past a point
- B. resistance to the movement of a charge past a point
- C. energy used to move a charge past a point
- D. amount of charge that moves past a point per unit time
- E. speed with which a charge moves past a point

ans: D

9. A 60-watt light bulb carries a current of 0.5 A. The total charge passing through it in one hour is:

- A. 120 C
- B. 3600 C
- C. 3000 C
- D. 2400 C
- E. 1800 C

ans: E

10. A 10-ohm resistor has a constant current. If 1200 C of charge flow through it in 4 minutes what is the value of the current?

- A. 3.0 A
- B. 5.0 A
- C. 11 A
- D. 15 A
- E. 20 A

ans: D

11. Conduction electrons move to the right in a certain wire. This indicates that:
- A. the current density and electric field both point right
 - B. the current density and electric field both point left
 - C. the current density points right and the electric field points left
 - D. the current density points left and the electric field points right
 - E. the current density points left but the direction of the electric field is unknown
- ans: B
12. Two wires made of different materials have the same uniform current density. They carry the same current only if:
- A. their lengths are the same
 - B. their cross-sectional areas are the same
 - C. both their lengths and cross-sectional areas are the same
 - D. the potential differences across them are the same
 - E. the electric fields in them are the same
- ans: B
13. A wire with a length of 150 m and a radius of 0.15 mm carries a current with a uniform current density of $2.8 \times 10^7 \text{ A/m}^2$. The current is:
- A. 0.63 A^2
 - B. 2.0 A
 - C. 5.9 A^2
 - D. 296 A
 - E. 400 A^2
- ans: B
14. In a conductor carrying a current we expect the electron drift speed to be:
- A. much greater than the average electron speed
 - B. much less than the average electron speed
 - C. about the same as the average electron speed
 - D. less than the average electron speed at low temperature and greater than the average electron speed at high temperature
 - E. less than the average electron speed at high temperature and greater than the average electron speed at low temperature
- ans: B
15. Two substances are identical except that the electron mean free time for substance A is twice the electron mean free time for substance B. If the same electric field exists in both substances the electron drift speed in A is:
- A. the same as in B
 - B. twice that in B
 - C. half that in B
 - D. four times that in B
 - E. one-fourth that in B
- ans: B

16. The current is zero in a conductor when no potential difference is applied because:
- A. the electrons are not moving
 - B. the electrons are not moving fast enough
 - C. for every electron with a given velocity there is another with a velocity of equal magnitude and opposite direction.
 - D. equal numbers of electrons and protons are moving together
 - E. otherwise Ohm's law would not be valid
- ans: C
17. The current density is the same in two wires. Wire A has twice the free-electron concentration of wire B. The drift speed of electrons in A is:
- A. twice that of electrons in B
 - B. four times that of electrons in B
 - C. half that of electrons in B
 - D. one-fourth that of electrons in B
 - E. the same as that of electrons in B
- ans: C
18. Copper contains 8.4×10^{28} free electrons/ m^3 . A copper wire of cross-sectional area $7.4 \times 10^{-7} \text{ m}^2$ carries a current of 1 A. The electron drift speed is approximately:
- A. $3 \times 10^8 \text{ m/s}$
 - B. 10^3 m/s
 - C. 1 m/s
 - D. 10^{-4} m/s
 - E. 10^{-23} m/s
- ans: D
19. If \vec{J} is the current density and $d\vec{A}$ is a vector element of area then the integral $\int \vec{J} \cdot d\vec{A}$ over an area represents:
- A. the electric flux through the area
 - B. the average current density at the position of the area
 - C. the resistance of the area
 - D. the resistivity of the area
 - E. the current through the area
- ans: E
20. If the potential difference across a resistor is doubled:
- A. only the current is doubled
 - B. only the current is halved
 - C. only the resistance is doubled
 - D. only the resistance is halved
 - E. both the current and resistance are doubled
- ans: A

21. Five cylindrical wires are made of the same material. Their lengths and radii are

wire 1: length ℓ , radius r
wire 2: length $\ell/4$, radius $r/2$
wire 3: length $\ell/2$, radius $r/2$
wire 4: length ℓ , radius $r/2$
wire 5: length 5ℓ , radius $2r$

Rank the wires according to their resistances, least to greatest.

- A. 1, 2, 3, 4, 5
B. 5, 4, 3, 2, 1
C. 1 and 2 tie, then 5, 3, 4
D. 1, 3, 4, 2, 5
E. 1, 2, 4, 3, 5

ans: C

22. Of the following, the copper conductor that has the least resistance is:

- A. thin, long and hot
B. thick, short and cool
C. thick, long and hot
D. thin, short and cool
E. thin, short and hot

ans: B

23. A cylindrical copper rod has resistance R . It is reformed to twice its original length with no change of volume. Its new resistance is:

- A. R
B. $2R$
C. $4R$
D. $8R$
E. $R/2$

ans: C

24. The resistance of a rod does NOT depend on:

- A. its temperature
B. its material
C. its length
D. its conductivity
E. the shape of its (fixed) cross-sectional area

ans: E

25. A certain wire has resistance R . Another wire, of the same material, has half the length and half the diameter of the first wire. The resistance of the second wire is:

- A. $R/4$
B. $R/2$
C. R
D. $2R$
E. $4R$

ans: D

26. A nichrome wire is 1 m long and $1 \times 10^{-6} \text{ m}^2$ in cross-sectional area. When connected to a potential difference of 2 V, a current of 4 A exists in the wire. The resistivity of this nichrome is:
- A. $10^{-7} \Omega \cdot \text{m}$
 - B. $2 \times 10^{-7} \Omega \cdot \text{m}$
 - C. $4 \times 10^{-7} \Omega \cdot \text{m}$
 - D. $5 \times 10^{-7} \Omega \cdot \text{m}$
 - E. $8 \times 10^{-7} \Omega \cdot \text{m}$
- ans: D
27. Two conductors are made of the same material and have the same length. Conductor A is a solid wire of diameter 1 m. Conductor B is a hollow tube of inside diameter 1 m and outside diameter 2 m. The ratio of their resistance, R_A/R_B , is:
- A. 1
 - B. $\sqrt{2}$
 - C. 2
 - D. 3
 - E. 4
- ans: D
28. Conductivity is:
- A. the same as resistivity, it is just more convenient to use for good conductors
 - B. expressed in Ω^{-1}
 - C. equal to 1/resistance
 - D. expressed in $(\Omega \cdot \text{m})^{-1}$
 - E. not a meaningful quantity for an insulator
- ans: D
29. A certain sample carries a current of 4 A when the potential difference is 2 V and a current of 10 A when the potential difference is 4 V. This sample:
- A. obeys Ohm's law
 - B. has a resistance of 0.5Ω at 1 V
 - C. has a resistance of 2.5Ω at 1 V
 - D. has a resistance of 2.5Ω at 2 V
 - E. does not have a resistance
- ans: B
30. A current of 0.5 A exists in a 60-ohm lamp. The applied potential difference is:
- A. 15 V
 - B. 30 V
 - C. 60 V
 - D. 120 V
 - E. none of these
- ans: B

31. Which of the following graphs best represents the current-voltage relationship of an incandescent light bulb?

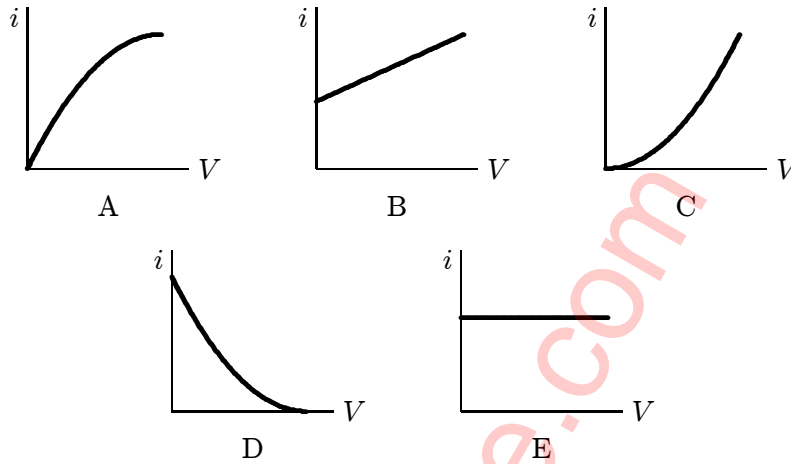

ans: A

32. Which of the following graphs best represents the current-voltage relationship for a device that obeys Ohm's law?

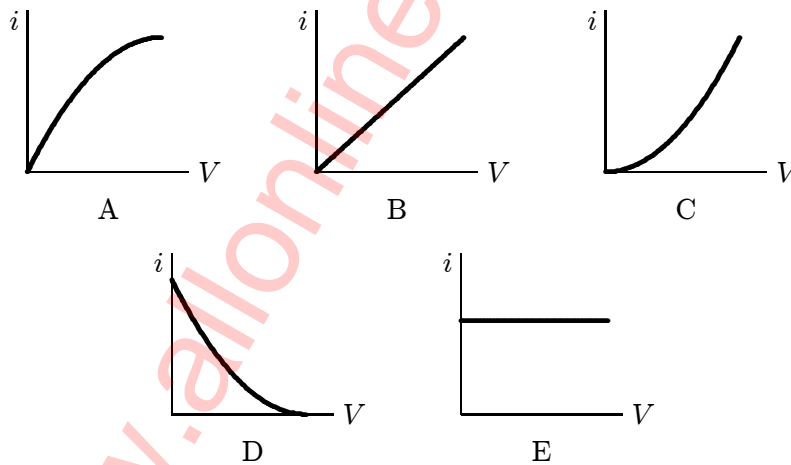

ans: B

33. Two wires are made of the same material and have the same length but different radii. They are joined end-to-end and a potential difference is maintained across the combination. Of the following the quantity that is the same for both wires is:

- A. potential difference
- B. current
- C. current density
- D. electric field
- E. conduction electron drift speed

ans: B

34. For an ohmic substance the resistivity is the proportionality constant for:
- A. current and potential difference
 - B. current and electric field
 - C. current density and potential difference
 - D. current density and electric field
 - E. potential difference and electric field
- ans: D
35. For an ohmic resistor, resistance is the proportionality constant for:
- A. potential difference and electric field
 - B. current and electric field
 - C. current and length
 - D. current and cross-sectional area
 - E. current and potential difference
- ans: E
36. For an ohmic substance, the resistivity depends on:
- A. the electric field
 - B. the potential difference
 - C. the current density
 - D. the electron mean free time
 - E. the cross-sectional area of the sample
- ans: D
37. For a cylindrical resistor made of ohmic material, the resistance does NOT depend on:
- A. the current
 - B. the length
 - C. the cross-sectional area
 - D. the resistivity
 - E. the electron drift velocity
- ans: A
38. For an ohmic substance, the electron drift velocity is proportional to:
- A. the cross-sectional area of the sample
 - B. the length of the sample
 - C. the mass of an electron
 - D. the electric field in the sample
 - E. none of the above
- ans: D

39. You wish to triple the rate of energy dissipation in a heating device. To do this you could triple:
- A. the potential difference keeping the resistance the same
 - B. the current keeping the resistance the same
 - C. the resistance keeping the potential difference the same
 - D. the resistance keeping the current the same
 - E. both the potential difference and current
- ans: D
40. A student kept her 60-watt, 120-volt study lamp turned on from 2:00 PM until 2:00 AM. How many coulombs of charge went through it?
- A. 150
 - B. 3,600
 - C. 7,200
 - D. 18,000
 - E. 21,600
- ans: E
41. A flat iron is marked "120 V, 600 W". In normal use, the current in it is:
- A. 2 A
 - B. 4 A
 - C. 5 A
 - D. 7.2 A
 - E. 0.2 A
- ans: C
42. An certain resistor dissipates 0.5 W when connected to a 3 V potential difference. When connected to a 1 V potential difference, this resistor will dissipate:
- A. 0.5 W
 - B. 0.167 W
 - C. 1.5 W
 - D. 0.056 W
 - E. none of these
- ans: D
43. An ordinary light bulb is marked "60 W, 120 V". Its resistance is:
- A. $60\ \Omega$
 - B. $120\ \Omega$
 - C. $180\ \Omega$
 - D. $240\ \Omega$
 - E. $15\ \Omega$
- ans: D

44. The mechanical equivalent of heat is $1 \text{ cal} = 4.18 \text{ J}$. The specific heat of water is $1 \text{ cal/g} \cdot \text{K}$. An electric immersion water heater, rated at 400 W , should heat a kilogram of water from 10° C to 30° C in about:
- A. 3.5 min
 - B. 1 min
 - C. 15 min
 - D. 45 min
 - E. 15 s
- ans: A
45. It is better to send $10,000 \text{ kW}$ of electric power long distances at $10,000 \text{ V}$ rather than at 220 V because:
- A. there is less heating in the transmission wires
 - B. the resistance of the wires is less at high voltages
 - C. more current is transmitted at high voltages
 - D. the insulation is more effective at high voltages
 - E. the iR drop along the wires is greater at high voltage
- ans: A
46. Suppose the electric company charges 10 cents per $\text{kW}\cdot\text{h}$. How much does it cost to use a 125 W lamp 4 hours a day for 30 days?
- A. \$1.20
 - B. \$1.50
 - C. \$1.80
 - D. \$7.20
 - E. none of these
- ans: B
47. A certain x-ray tube requires a current of 7 mA at a voltage of 80 kV . The rate of energy dissipation (in watts) is:
- A. 560
 - B. 5600
 - C. 26
 - D. 11.4
 - E. 87.5
- ans: A
48. The mechanical equivalent of heat is $1 \text{ cal} = 4.18 \text{ J}$. A heating coil, connected to a 120-V source, provides $60,000$ calories in 10 minutes. The current in the coil is:
- A. 0.83 A
 - B. 2 A
 - C. 3.5 A
 - D. 20 A
 - E. 50 A
- ans: C

49. You buy a “75 W” light bulb. The label means that:
- A. no matter how you use the bulb, the power will be 75 W
 - B. the bulb was filled with 75 W at the factory
 - C. the actual power dissipated will be much higher than 75 W since most of the power appears as heat
 - D. the bulb is expected to burn out after you use up its 75 W
 - E. none of the above

ans: E

50. A current of 0.3 A is passed through a lamp for 2 minutes using a 6-V power supply. The energy dissipated by this lamp during the 2 minutes is:

- A. 1.8 J
- B. 12 J
- C. 20 J
- D. 36 J
- E. 216 J

ans: E

www.allonlinefree.com

Chapter 27: CIRCUITS

1. “The sum of the currents into a junction equals the sum of the currents out of the junction” is a consequence of:
- A. Newton’s third law
 - B. Ohm’s law
 - C. Newton’s second law
 - D. conservation of energy
 - E. conservation of charge

ans: E

2. “The sum of the emf’s and potential differences around a closed loop equals zero” is a consequence of:
- A. Newton’s third law
 - B. Ohm’s law
 - C. Newton’s second law
 - D. conservation of energy
 - E. conservation of charge

ans: D

3. A portion of a circuit is shown, with the values of the currents given for some branches. What is the direction and value of the current i ?

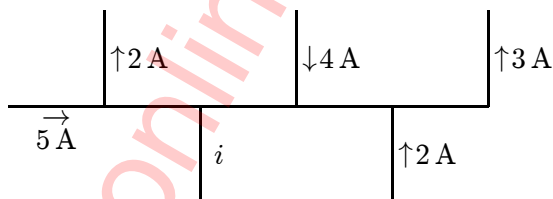

- A. ↓, 6 A
- B. ↑, 6 A
- C. ↓, 4 A
- D. ↑, 4 A
- E. ↓, 2 A

ans: A

4. Four wires meet at a junction. The first carries 4 A into the junction, the second carries 5 A out of the junction, and the third carries 2 A out of the junction. The fourth carries:
- A. 7 A out of the junction
 - B. 7 A into the junction
 - C. 3 A out of the junction
 - D. 3 A into the junction
 - E. 1 A into the junction

ans: D

5. In the context of the loop and junctions rules for electrical circuits a junction is:
- A. where a wire is connected to a resistor
 - B. where a wire is connected to a battery
 - C. where only two wires are joined
 - D. where three or more wires are joined
 - E. where a wire is bent
- ans: D
6. For any circuit the number of independent equations containing emf's, resistances, and currents equals:
- A. the number of junctions
 - B. the number of junctions minus 1
 - C. the number of branches
 - D. the number of branches minus 1
 - E. the number of closed loops
- ans: C
7. If a circuit has L closed loops, B branches, and J junctions the number of independent loop equations is:
- A. $B - J + 1$
 - B. $B - J$
 - C. B
 - D. L
 - E. $L - J$
- ans: A
8. A battery is connected across a series combination of two identical resistors. If the potential difference across the terminals is V and the current in the battery is i , then:
- A. the potential difference across each resistor is V and the current in each resistor is i
 - B. the potential difference across each resistor is $V/2$ and the current in each resistor is $i/2$
 - C. the potential difference across each resistor is V and the current in each resistor is $i/2$
 - D. the potential difference across each resistor is $V/2$ and the current in each resistor is i
 - E. none of the above are true
- ans: D
9. A battery is connected across a parallel combination of two identical resistors. If the potential difference across the terminals is V and the current in the battery is i , then:
- A. the potential difference across each resistor is V and the current in each resistor is i
 - B. the potential difference across each resistor is $V/2$ and the current in each resistor is $i/2$
 - C. the potential difference across each resistor is V and the current in each resistor is $i/2$
 - D. the potential difference across each resistor is $V/2$ and the current in each resistor is i
 - E. none of the above are true
- ans: C

10. A total resistance of $3.0\ \Omega$ is to be produced by combining an unknown resistor R with a $12\ \Omega$ resistor. What is the value of R and how is it to be connected to the $12\ \Omega$ resistor?
- A. $4.0\ \Omega$, parallel
 - B. $4.0\ \Omega$, series
 - C. $2.4\ \Omega$, parallel
 - D. $2.4\ \Omega$, series
 - E. $9.0\ \Omega$, series
- ans: A
11. By using only two resistors, R_1 and R_2 , a student is able to obtain resistances of $3\ \Omega$, $4\ \Omega$, $12\ \Omega$, and $16\ \Omega$. The values of R_1 and R_2 (in ohms) are:
- A. 3, 4
 - B. 2, 12
 - C. 3, 16
 - D. 4, 12
 - E. 4, 16
- ans: D
12. Four $20\text{-}\Omega$ resistors are connected in parallel and the combination is connected to a 20-V emf device. The current in the device is:
- A. $0.25\ \text{A}$
 - B. $1.0\ \text{A}$
 - C. $4.0\ \text{A}$
 - D. $5.0\ \text{A}$
 - E. $100\ \text{A}$
- ans: C
13. Four $20\text{-}\Omega$ resistors are connected in parallel and the combination is connected to a 20-V emf device. The current in any one of the resistors is:
- A. $0.25\ \text{A}$
 - B. $1.0\ \text{A}$
 - C. $4.0\ \text{A}$
 - D. $5.0\ \text{A}$
 - E. $100\ \text{A}$
- ans: B
14. Four $20\text{-}\Omega$ resistors are connected in series and the combination is connected to a 20-V emf device. The current in any one of the resistors is:
- A. $0.25\ \text{A}$
 - B. $1.0\ \text{A}$
 - C. $4.0\ \text{A}$
 - D. $5.0\ \text{A}$
 - E. $100\ \text{A}$
- ans: A

15. Four $20\text{-}\Omega$ resistors are connected in series and the combination is connected to a 20-V emf device. The potential difference across any one of the resistors is:
- A. 1 V
 - B. 4 V
 - C. 5 V
 - D. 20 V
 - E. 80 V
- ans: C
16. Nine identical wires, each of diameter d and length L , are connected in parallel. The combination has the same resistance as a single similar wire of length L but whose diameter is:
- A. $3d$
 - B. $9d$
 - C. $d/3$
 - D. $d/9$
 - E. $d/81$
- ans: A
17. Nine identical wires, each of diameter d and length L , are connected in series. The combination has the same resistance as a single similar wire of length L but whose diameter is:
- A. $3d$
 - B. $9d$
 - C. $d/3$
 - D. $d/9$
 - E. $d/81$
- ans: C
18. Two wires made of the same material have the same lengths but different diameters. They are connected in parallel to a battery. The quantity that is NOT the same for the wires is:
- A. the end-to-end potential difference
 - B. the current
 - C. the current density
 - D. the electric field
 - E. the electron drift velocity
- ans: B
19. Two wires made of the same material have the same lengths but different diameters. They are connected in series to a battery. The quantity that is the same for the wires is:
- A. the end-to-end potential difference
 - B. the current
 - C. the current density
 - D. the electric field
 - E. the electron drift velocity
- ans: B

20. The equivalent resistance between points 1 and 2 of the circuit shown is:

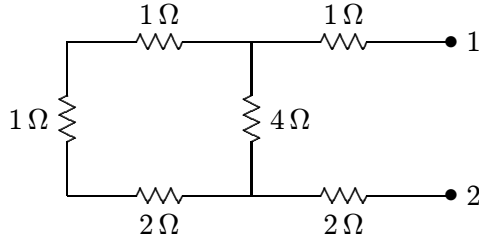

- A. $3\ \Omega$
- B. $4\ \Omega$
- C. $5\ \Omega$
- D. $6\ \Omega$
- E. $7\ \Omega$

ans: C

21. Each of the resistors in the diagram has a resistance of $12\ \Omega$. The resistance of the entire circuit is:

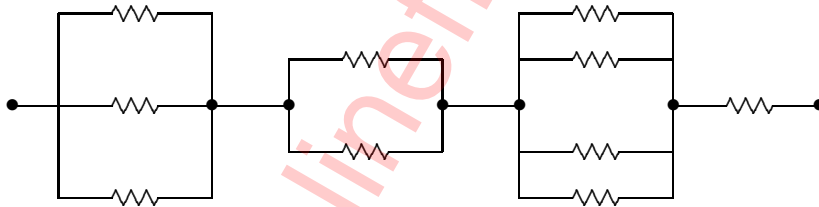

- A. $5.76\ \Omega$
- B. $25\ \Omega$
- C. $48\ \Omega$
- D. $120\ \Omega$
- E. none of these

ans: B

22. The resistance of resistor 1 is twice the resistance of resistor 2. The two are connected in parallel and a potential difference is maintained across the combination. Then:

- A. the current in 1 is twice that in 2
- B. the current in 1 is half that in 2
- C. the potential difference across 1 is twice that across 2
- D. the potential difference across 1 is half that across 2
- E. none of the above are true

ans: B

23. The resistance of resistor 1 is twice the resistance of resistor 2. The two are connected in series and a potential difference is maintained across the combination. Then:
- A. the current in 1 is twice that in 2
 - B. the current in 1 is half that in 2
 - C. the potential difference across 1 is twice that across 2
 - D. the potential difference across 1 is half that across 2
 - E. none of the above are true
- ans: C
24. Resistor 1 has twice the resistance of resistor 2. The two are connected in series and a potential difference is maintained across the combination. The rate of thermal energy generation in 1 is:
- A. the same as that in 2
 - B. twice that in 2
 - C. half that in 2
 - D. four times that in 2
 - E. one-fourth that in 2
- ans: B
25. Resistor 1 has twice the resistance of resistor 2. The two are connected in parallel and a potential difference is maintained across the combination. The rate of thermal energy generation in 1 is:
- A. the same as that in 2
 - B. twice that in 2
 - C. half that in 2
 - D. four times that in 2
 - E. one-fourth that in 2
- ans: C
26. The emf of a battery is equal to its terminal potential difference:
- A. under all conditions
 - B. only when the battery is being charged
 - C. only when a large current is in the battery
 - D. only when there is no current in the battery
 - E. under no conditions
- ans: D
27. The terminal potential difference of a battery is less than its emf:
- A. under all conditions
 - B. only when the battery is being charged
 - C. only when the battery is being discharged
 - D. only when there is no current in the battery
 - E. under no conditions
- ans: C

28. A battery has an emf of 9 V and an internal resistance of $2\ \Omega$. If the potential difference across its terminals is greater than 9 V:
- it must be connected across a large external resistance
 - it must be connected across a small external resistance
 - the current must be out of the positive terminal
 - the current must be out of the negative terminal
 - the current must be zero

ans: D

29. A battery with an emf of 24 V is connected to a $6\text{-}\Omega$ resistor. As a result, current of 3 A exists in the resistor. The terminal potential difference of the battery is:
- 0
 - 6 V
 - 12 V
 - 18 V
 - 24 V

ans: D

30. In the diagram $R_1 > R_2 > R_3$. Rank the three resistors according to the current in them, least to greatest.

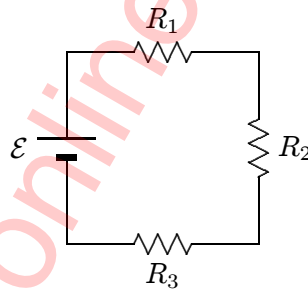

- 1, 2, 3
- 3, 2, 1
- 1, 3, 2
- 3, 1, 3
- All are the same

ans: E

31. Resistances of $2.0\ \Omega$, $4.0\ \Omega$, and $6.0\ \Omega$ and a 24-V emf device are all in parallel. The current in the $2.0\text{-}\Omega$ resistor is:
- 12 A
 - 4.0 A
 - 2.4 A
 - 2.0 A
 - 0.50 A

ans: A

32. Resistances of $2.0\ \Omega$, $4.0\ \Omega$, and $6.0\ \Omega$ and a 24-V emf device are all in series. The potential difference across the $2.0\text{-}\Omega$ resistor is:
- A. 4 V
 - B. 8 V
 - C. 12 V
 - D. 24 V
 - E. 48 V
- ans: A

33. A battery with an emf of 12 V and an internal resistance of $1\ \Omega$ is used to charge a battery with an emf of 10 V and an internal resistance of $1\ \Omega$. The current in the circuit is:
- A. 1 A
 - B. 2 A
 - C. 4 A
 - D. 11 A
 - E. 22 A
- ans: A

34. In the diagram, the current in the $3\text{-}\Omega$ resistor is 4 A. The potential difference between points 1 and 2 is:



- A. 0.75 V
 - B. 0.8 V
 - C. 1.25 V
 - D. 12 V
 - E. 20 V
- ans: E

35. The current in the $5.0\text{-}\Omega$ resistor in the circuit shown is:

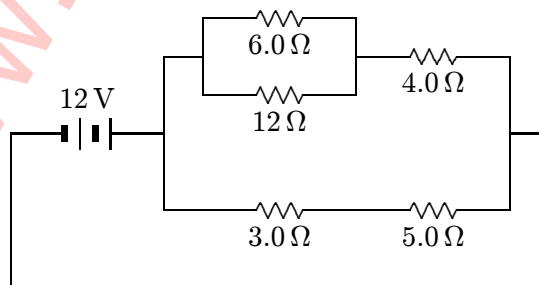

- A. 0.42 A
 - B. 0.67 A
 - C. 1.5 A
 - D. 2.4 A
 - E. 3.0 A
- ans: C

36. A $3\text{-}\Omega$ and a $1.5\text{-}\Omega$ resistor are wired in parallel and the combination is wired in series to a $4\text{-}\Omega$ resistor and a 10-V emf device. The current in the $3\text{-}\Omega$ resistor is:
- A. 0.33 A
 - B. 0.67 A
 - C. 2.0 A
 - D. 3.3 A
 - E. 6.7 A
- ans: B
37. A $3\text{-}\Omega$ and a $1.5\text{-}\Omega$ resistor are wired in parallel and the combination is wired in series to a $4\text{-}\Omega$ resistor and a 10-V emf device. The potential difference across the $3\text{-}\Omega$ resistor is:
- A. 2.0 V
 - B. 6.0 V
 - C. 8.0 V
 - D. 10 V
 - E. 12 V
- ans: A
38. Two identical batteries, each with an emf of 18 V and an internal resistance of $1\ \Omega$, are wired in parallel by connecting their positive terminals together and connecting their negative terminals together. The combination is then wired across a $4\text{-}\Omega$ resistor. The current in the $4\text{-}\Omega$ resistor is:
- A. 1.0 A
 - B. 2.0 A
 - C. 4.0 A
 - D. 3.6 A
 - E. 7.2 A
- ans: C
39. Two identical batteries, each with an emf of 18 V and an internal resistance of $1\ \Omega$, are wired in parallel by connecting their positive terminals together and connecting their negative terminals together. The combination is then wired across a $4\text{-}\Omega$ resistor. The current in each battery is:
- A. 1.0 A
 - B. 2.0 A
 - C. 4.0 A
 - D. 3.6 A
 - E. 7.2 A
- ans: B

40. Two identical batteries, each with an emf of 18 V and an internal resistance of $1\ \Omega$, are wired in parallel by connecting their positive terminals together and connecting their negative terminals together. The combination is then wired across a $4\text{-}\Omega$ resistor. The potential difference across the $4\text{-}\Omega$ resistor is:
- A. 4.0 V
 - B. 8.0 V
 - C. 14 V
 - D. 16 V
 - E. 29 V

ans: D

41. In the diagrams, all light bulbs are identical and all emf devices are identical. In which circuit (A, B, C, D, E) will the bulbs glow with the same brightness as in circuit X?

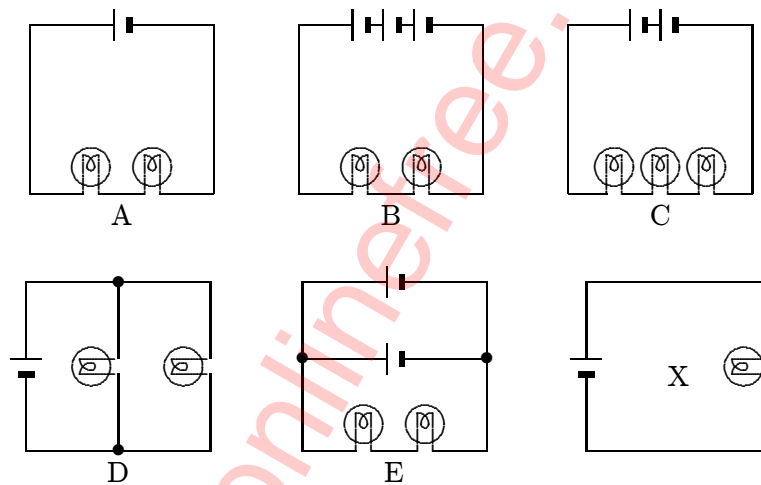

ans: D

42. In the diagrams, all light bulbs are identical and all emf devices are identical. In which circuit (A, B, C, D, E) will the bulbs be dimmest?

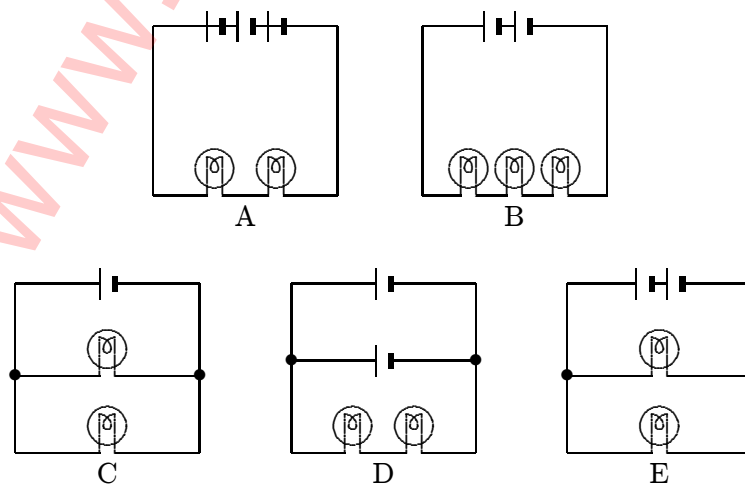

ans: D

43. A 120-V power line is protected by a 15-A fuse. What is the maximum number of “120 V, 500 W” light bulbs that can be operated at full brightness from this line?
- A. 1
 - B. 2
 - C. 3
 - D. 4
 - E. 5
- ans: C
44. Two 110-V light bulbs, one “25 W” and the other “100 W”, are connected in series to a 110 V source. Then:
- A. the current in the 100-W bulb is greater than that in the 25-W bulb
 - B. the current in the 100-W bulb is less than that in the 25-W bulb
 - C. both bulbs will light with equal brightness
 - D. each bulb will have a potential difference of 55 V
 - E. none of the above
- ans: E
45. A resistor with resistance R_1 and a resistor with resistance R_2 are connected in parallel to an ideal battery with emf \mathcal{E} . The rate of thermal energy generation in the resistor with resistance R_1 is:
- A. \mathcal{E}^2/R_1
 - B. $\mathcal{E}^2 R_1/(R_1 + R_2)^2$
 - C. $\mathcal{E}^2/(R_1 + R_2)$
 - D. \mathcal{E}^2/R_2
 - E. $\mathcal{E}^2 R_1/R_2^2$
- ans: A
46. In an antique automobile, a 6-V battery supplies a total of 48 W to two identical headlights in parallel. The resistance (in ohms) of each bulb is:
- A. 0.67
 - B. 1.5
 - C. 3
 - D. 4
 - E. 8
- ans: B
47. Resistor 1 has twice the resistance of resistor 2. They are connected in parallel to a battery. The ratio of the thermal energy generation rate in 1 to that in 2 is:
- A. 1 : 4
 - B. 1 : 2
 - C. 1 : 1
 - D. 2 : 1
 - E. 4 : 1
- ans: B

48. A series circuit consists of a battery with internal resistance r and an external resistor R . If these two resistances are equal ($r = R$) then the thermal energy generated per unit time by the internal resistance r is:
- the same as by R
 - half that by R
 - twice that by R
 - one-third that by R
 - unknown unless the emf is given

ans: A

49. The positive terminals of two batteries with emf's of \mathcal{E}_1 and \mathcal{E}_2 , respectively, are connected together. Here $\mathcal{E}_2 > \mathcal{E}_1$. The circuit is completed by connecting the negative terminals. If each battery has an internal resistance r , the rate with which electrical energy is converted to chemical energy in the smaller battery is:

- \mathcal{E}_1^2/r
- $\mathcal{E}_1^2/2r$
- $(\mathcal{E}_2 - \mathcal{E}_1)\mathcal{E}_1/r$
- $(\mathcal{E}_2 - \mathcal{E}_1)\mathcal{E}_1/2r$
- $\mathcal{E}_2^2/2r$

ans: D

50. In the figure, voltmeter V_1 reads 600 V, voltmeter V_2 reads 580 V, and ammeter A reads 100 A. The power wasted in the transmission line connecting the power house to the consumer is:

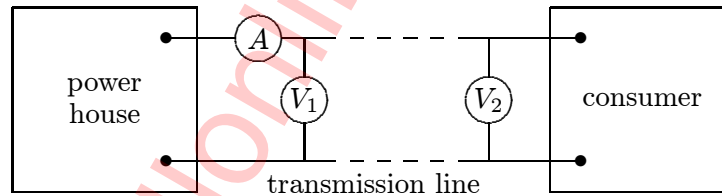

- 1 kW
- 2 kW
- 58 kW
- 59 kW
- 60 kW

ans: B

51. The circuit shown was wired for the purpose of measuring the resistance of the lamp L. Inspection shows that:

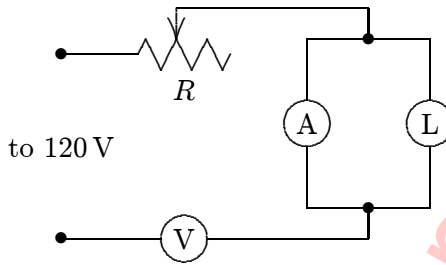

- A. voltmeter V and rheostat R should be interchanged
- B. the circuit is satisfactory
- C. the ammeter A should be in parallel with R, not L
- D. the meters, V and A, should be interchanged
- E. L and V should be interchanged

ans: D

52. When switch S is open, the ammeter in the circuit shown reads 2.0 A. When S is closed, the ammeter reading:

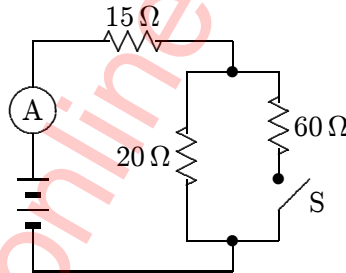

- A. increases slightly
- B. remains the same
- C. decreases slightly
- D. doubles
- E. halves

ans: A

53. A certain galvanometer has a resistance of $100\ \Omega$ and requires 1 mA for full scale deflection. To make this into a voltmeter reading 1 V full scale, connect a resistance of:

- A. $1000\ \Omega$ in parallel
- B. $900\ \Omega$ in series
- C. $1000\ \Omega$ in series
- D. $10\ \Omega$ in parallel
- E. $0.1\ \Omega$ in series

ans: B

54. To make a galvanometer into an ammeter, connect:
- A. a high resistance in parallel
 - B. a high resistance in series
 - C. a low resistance in series
 - D. a low resistance in parallel
 - E. a source of emf in series
- ans: D
55. A certain voltmeter has an internal resistance of $10,000\ \Omega$ and a range from 0 to 100 V. To give it a range from 0 to 1000 V, one should connect:
- A. $100,000\ \Omega$ in series
 - B. $100,000\ \Omega$ in parallel
 - C. $1000\ \Omega$ in series
 - D. $1000\ \Omega$ in parallel
 - E. $90,000\ \Omega$ in series
- ans: E
56. A certain ammeter has an internal resistance of $1\ \Omega$ and a range from 0 to 50 mA. To make its range from 0 to 5 A, use:
- A. a series resistance of $99\ \Omega$
 - B. an extremely large (say $10^6\ \Omega$) series resistance
 - C. a resistance of $99\ \Omega$ in parallel
 - D. a resistance of $1/99\ \Omega$ in parallel
 - E. a resistance of $1/1000\ \Omega$ in parallel
- ans: D
57. A galvanometer has an internal resistance of $12\ \Omega$ and requires 0.01 A for full scale deflection. To convert it to a voltmeter reading 3 V full scale, one must use a series resistance of:
- A. $102\ \Omega$
 - B. $288\ \Omega$
 - C. $300\ \Omega$
 - D. $360\ \Omega$
 - E. $412\ \Omega$
- ans: B
58. A certain voltmeter has an internal resistance of $10,000\ \Omega$ and a range from 0 to 12 V. To extend its range to 120 V, use a series resistance of:
- A. $1,111\ \Omega$
 - B. $90,000\ \Omega$
 - C. $100,000\ \Omega$
 - D. $108,000\ \Omega$
 - E. $120,000\ \Omega$
- ans: B

59. Four circuits have the form shown in the diagram. The capacitor is initially uncharged and the switch S is open.

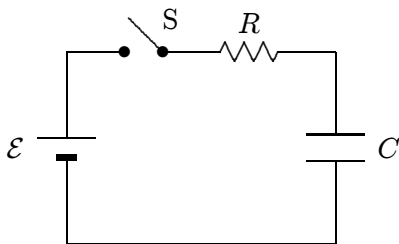

The values of the emf \mathcal{E} , resistance R , and capacitance C for each of the circuits are

circuit 1: $\mathcal{E} = 18 \text{ V}$, $R = 3 \Omega$, $C = 1 \mu\text{F}$

circuit 2: $\mathcal{E} = 18 \text{ V}$, $R = 6 \Omega$, $C = 9 \mu\text{F}$

circuit 3: $\mathcal{E} = 12 \text{ V}$, $R = 1 \Omega$, $C = 7 \mu\text{F}$

circuit 4: $\mathcal{E} = 10 \text{ V}$, $R = 5 \Omega$, $C = 7 \mu\text{F}$

Rank the circuits according to the current just after switch S is closed least to greatest.

- A. 1, 2, 3, 4
- B. 4, 3, 2, 1
- C. 4, 2, 3, 1
- D. 4, 2, 1, 3
- E. 3, 1, 2, 4

ans: D

60. Four circuits have the form shown in the diagram. The capacitor is initially uncharged and the switch S is open.

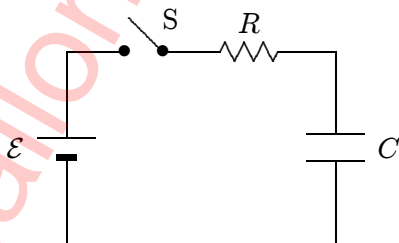

The values of the emf \mathcal{E} , resistance R , and capacitance C for each of the circuits are

circuit 1: $\mathcal{E} = 18 \text{ V}$, $R = 3 \Omega$, $C = 1 \mu\text{F}$

circuit 2: $\mathcal{E} = 18 \text{ V}$, $R = 6 \Omega$, $C = 9 \mu\text{F}$

circuit 3: $\mathcal{E} = 12 \text{ V}$, $R = 1 \Omega$, $C = 7 \mu\text{F}$

circuit 4: $\mathcal{E} = 10 \text{ V}$, $R = 5 \Omega$, $C = 7 \mu\text{F}$

Rank the circuits according to the time after switch S is closed for the capacitors to reach half their final charges, least to greatest.

- A. 1, 2, 3, 4
- B. 4, 3, 2, 1
- C. 1, 3, 4, 2
- D. 1 and 2 tied, then 4, 3
- E. 4, 3, then 1 and 2 tied

ans: C

61. The time constant RC has units of:

- A. second/farad
- B. second/ohm
- C. 1/second
- D. second/watt
- E. none of these

ans: E

62. In the circuit shown, both resistors have the same value R . Suppose switch S is initially closed. When it is then opened, the circuit has a time constant τ_a . Conversely, suppose S is initially open. When it is then closed, the circuit has a time constant τ_b . The ratio τ_a/τ_b is:

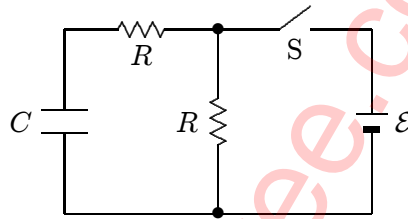

- A. 1
- B. 2
- C. 0.5
- D. 0.667
- E. 1.5

ans: B

63. In the circuit shown, the capacitor is initially uncharged. At time $t = 0$, switch S is closed. If τ denotes the time constant, the approximate current through the $3\ \Omega$ resistor when $t = \tau/10$ is:

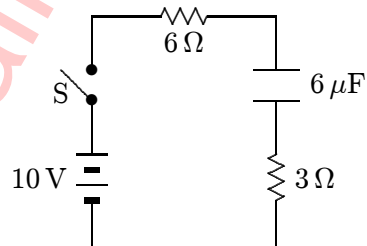

- A. 0.38 A
- B. 0.50 A
- C. 0.75 A
- D. 1.0 A
- E. 1.5 A

ans: D

64. Suppose the current charging a capacitor is kept constant. Which graph below correctly gives the potential difference V across the capacitor as a function of time?

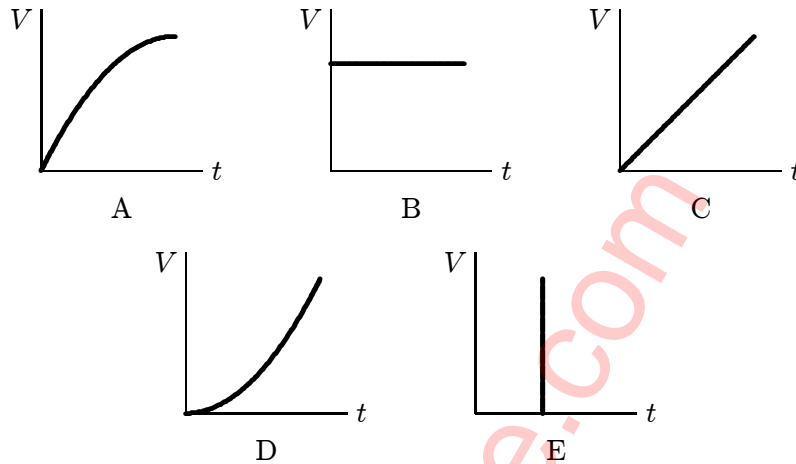

ans: C

65. A charged capacitor is being discharged through a resistor. At the end of one time constant the charge has been reduced by $(1 - 1/e) = 63\%$ of its initial value. At the end of two time constants the charge has been reduced by what percent of its initial value?
- 82%
 - 86%
 - 100%
 - Between 90% and 100%
 - Need to know more data to answer the question

ans: B

66. An initially uncharged capacitor C is connected in series with resistor R . This combination is then connected to a battery of emf V_0 . Sufficient time elapses so that a steady state is reached. Which of the following statements is NOT true?
- The time constant is independent of V_0
 - The final charge on C is independent of R
 - The total thermal energy generated by R is independent of R
 - The total thermal energy generated by R is independent of V_0
 - The initial current (just after the battery was connected) is independent of C

ans: C

67. A certain capacitor, in series with a resistor, is being charged. At the end of 10 ms its charge is half the final value. The time constant for the process is about:
- 0.43 ms
 - 2.3 ms
 - 6.9 ms
 - 10 ms
 - 14 ms

ans: E

68. A certain capacitor, in series with a $720\text{-}\Omega$ resistor, is being charged. At the end of 10 ms its charge is half the final value. The capacitance is about:
- A. $9.6\ \mu\text{F}$
 - B. $14\ \mu\text{F}$
 - C. $20\ \mu\text{F}$
 - D. $7.2\ \text{F}$
 - E. $10\ \text{F}$
- ans: C

69. In the capacitor discharge formula $q = q_0 e^{-t/RC}$ the symbol t represents:
- A. the time constant
 - B. the time it takes for C to lose the fraction $1/e$ of its initial charge
 - C. the time it takes for C to lose the fraction $(1 - 1/e)$ of its initial charge
 - D. the time it takes for C to lose essentially all of its initial charge
 - E. none of the above
- ans: E

Chapter 28: MAGNETIC FIELDS

1. Units of a magnetic field might be:

- A. $\text{C}\cdot\text{m}/\text{s}$
- B. $\text{C}\cdot\text{s}/\text{m}$
- C. C/kg
- D. $\text{kg}/\text{C}\cdot\text{s}$
- E. $\text{N}/\text{C}\cdot\text{m}$

ans: D

2. In the formula $\vec{F} = q\vec{v} \times \vec{B}$:

- A. \vec{F} must be perpendicular to \vec{v} but not necessarily to \vec{B}
- B. \vec{F} must be perpendicular to \vec{B} but not necessarily to \vec{v}
- C. \vec{v} must be perpendicular to \vec{B} but not necessarily to \vec{F}
- D. all three vectors must be mutually perpendicular
- E. \vec{F} must be perpendicular to both \vec{v} and \vec{B}

ans: E

3. An electron moves in the negative x direction, through a uniform magnetic field in the negative y direction. The magnetic force on the electron is:

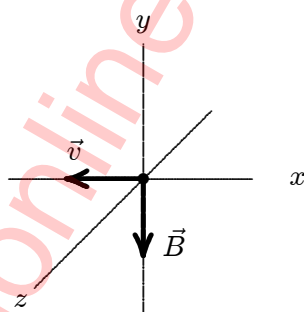

- A. in the negative x direction
- B. in the positive y direction
- C. in the negative y direction
- D. in the positive z direction
- E. in the negative z direction

ans: E

4. At any point the magnetic field lines are in the direction of:

- A. the magnetic force on a moving positive charge
- B. the magnetic force on a moving negative charge
- C. the velocity of a moving positive charge
- D. the velocity of a moving negative charge
- E. none of the above

ans: E

5. The magnetic force on a charged particle is in the direction of its velocity if:
- A. it is moving in the direction of the field
 - B. it is moving opposite to the direction of the field
 - C. it is moving perpendicular to the field
 - D. it is moving in some other direction
 - E. never
- ans: E
6. A magnetic field exerts a force on a charged particle:
- A. always
 - B. never
 - C. if the particle is moving across the field lines
 - D. if the particle is moving along the field lines
 - E. if the particle is at rest
- ans: C
7. The direction of the magnetic field in a certain region of space is determined by firing a test charge into the region with its velocity in various directions in different trials. The field direction is:
- A. one of the directions of the velocity when the magnetic force is zero
 - B. the direction of the velocity when the magnetic force is a maximum
 - C. the direction of the magnetic force
 - D. perpendicular to the velocity when the magnetic force is zero
 - E. none of the above
- ans: A
8. An electron is moving north in a region where the magnetic field is south. The magnetic force exerted on the electron is:
- A. zero
 - B. up
 - C. down
 - D. east
 - E. west
- ans: A
9. A magnetic field CANNOT:
- A. exert a force on a charged particle
 - B. change the velocity of a charged particle
 - C. change the momentum of a charged particle
 - D. change the kinetic energy of a charged particle
 - E. change the trajectory of a charged particle
- ans: D

10. A proton (charge e), traveling perpendicular to a magnetic field, experiences the same force as an alpha particle (charge $2e$) which is also traveling perpendicular to the same field. The ratio of their speeds, $v_{\text{proton}}/v_{\text{alpha}}$, is:
- A. 0.5
 - B. 1
 - C. 2
 - D. 4
 - E. 8

ans: C

11. A hydrogen atom that has lost its electron is moving east in a region where the magnetic field is directed from south to north. It will be deflected:
- A. up
 - B. down
 - C. north
 - D. south
 - E. not at all

ans: A

12. A beam of electrons is sent horizontally down the axis of a tube to strike a fluorescent screen at the end of the tube. On the way, the electrons encounter a magnetic field directed vertically downward. The spot on the screen will therefore be deflected:
- A. upward
 - B. downward
 - C. to the right as seen from the electron source
 - D. to the left as seen from the electron source
 - E. not at all

ans: C

13. An electron (charge $= -1.6 \times 10^{-19}$ C) is moving at 3×10^5 m/s in the positive x direction. A magnetic field of 0.8 T is in the positive z direction. The magnetic force on the electron is:
- A. 0
 - B. 4×10^{-14} N, in the positive z direction
 - C. 4×10^{-14} N, in the negative z direction
 - D. 4×10^{-14} N, in the positive y direction
 - E. 4×10^{-14} N, in the negative y direction

ans: D

14. At one instant an electron (charge $= -1.6 \times 10^{-19}$ C) is moving in the xy plane, the components of its velocity being $v_x = 5 \times 10^5$ m/s and $v_y = 3 \times 10^5$ m/s. A magnetic field of 0.8 T is in the positive x direction. At that instant the magnitude of the magnetic force on the electron is:
- A. 0
 - B. 2.6×10^{-14} N
 - C. 3.8×10^{-14} N
 - D. 6.4×10^{-14} N
 - E. 1.0×10^{-13} N

ans: C

15. At one instant an electron (charge = -1.6×10^{-19} C) is moving in the xy plane, the components of its velocity being $v_x = 5 \times 10^5$ m/s and $v_y = 3 \times 10^5$ m/s. A magnetic field of 0.8 T is in the positive x direction. At that instant the magnitude of the magnetic force on the electron is:
- 0
 - 3.8×10^{-14} N
 - 5.1×10^{-14} N
 - 6.4×10^{-14} N
 - 7.5×10^{-14} N

ans: B

16. An electron travels due north through a vacuum in a region of uniform magnetic field \vec{B} that is also directed due north. It will:
- be unaffected by the field
 - speed up
 - slow down
 - follow a right-handed corkscrew path
 - follow a left-handed corkscrew path

ans: A

17. At one instant an electron is moving in the positive x direction along the x axis in a region where there is a uniform magnetic field in the positive z direction. When viewed from a point on the positive z axis, its subsequent motion is:
- straight ahead
 - counterclockwise around a circle in the xy plane
 - clockwise around a circle in the xy plane
 - in the positive z direction
 - in the negative z direction

ans: B

18. A uniform magnetic field is directed into the page. A charged particle, moving in the plane of the page, follows a clockwise spiral of decreasing radius as shown. A reasonable explanation is:

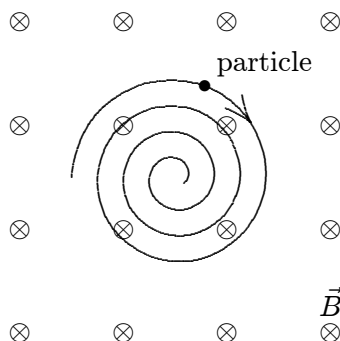

- the charge is positive and slowing down
- the charge is negative and slowing down
- the charge is positive and speeding up
- the charge is negative and speeding up
- none of the above

ans: B

19. An electron and a proton each travel with equal speeds around circular orbits in the same uniform magnetic field, as shown in the diagram (not to scale). The field is into the page on the diagram. Because the electron is less massive than the proton and because the electron is negatively charged and the proton is positively charged:

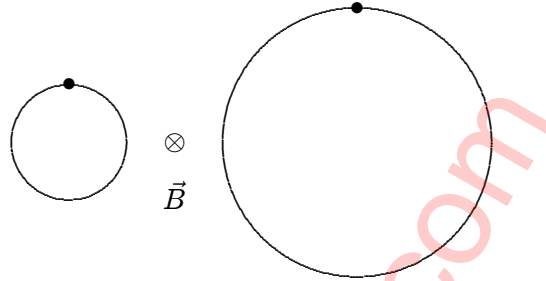

- A. the electron travels clockwise around the smaller circle and the proton travels counterclockwise around the larger circle
 B. the electron travels counterclockwise around the smaller circle and the proton travels clockwise around the larger circle
 C. the electron travels clockwise around the larger circle and the proton travels counterclockwise around the smaller circle
 D. the electron travels counterclockwise around the larger circle and the proton travels clockwise around the smaller circle
 E. the electron travels counterclockwise around the smaller circle and the proton travels counterclockwise around the larger circle
- ans: A
20. An electron is launched with velocity \vec{v} in a uniform magnetic field \vec{B} . The angle θ between \vec{v} and \vec{B} is between 0 and 90° . As a result, the electron follows a helix, its velocity vector \vec{v} returning to its initial value in a time interval of:
- A. $2\pi m/eB$
 B. $2\pi mv/eB$
 C. $2\pi mv \sin \theta/eB$
 D. $2\pi mv \cos \theta/eB$
 E. none of these
- ans: A
21. An electron and a proton are both initially moving with the same speed and in the same direction at 90° to the same uniform magnetic field. They experience magnetic forces, which are initially:
- A. identical
 B. equal in magnitude but opposite in direction
 C. in the same direction and differing in magnitude by a factor of 1840
 D. in opposite directions and differing in magnitude by a factor of 1840
 E. equal in magnitude but perpendicular to each other.
- ans: B

22. An electron enters a region of uniform perpendicular \vec{E} and \vec{B} fields. It is observed that the velocity \vec{v} of the electron is unaffected. A possible explanation is:
- \vec{v} is parallel to \vec{E} and has magnitude E/B
 - \vec{v} is parallel to \vec{B}
 - \vec{v} is perpendicular to both \vec{E} and \vec{B} and has magnitude B/E
 - \vec{v} is perpendicular to both \vec{E} and \vec{B} and has magnitude E/B
 - the given situation is impossible

ans: D

23. A charged particle is projected into a region of uniform, parallel, \vec{E} and \vec{B} fields. The force on the particle is:
- zero
 - at some angle $< 90^\circ$ with the field lines
 - along the field lines
 - perpendicular to the field lines
 - unknown (need to know the sign of the charge)

ans: B

24. A uniform magnetic field is in the positive z direction. A positively charged particle is moving in the positive x direction through the field. The net force on the particle can be made zero by applying an electric field in what direction?
- Positive y
 - Negative y
 - Positive x
 - Negative x
 - Positive z

ans: B

25. An electron is traveling in the positive x direction. A uniform electric field \vec{E} is in the negative y direction. If a uniform magnetic field with the appropriate magnitude and direction also exists in the region, the total force on the electron will be zero. The appropriate direction for the magnetic field is:

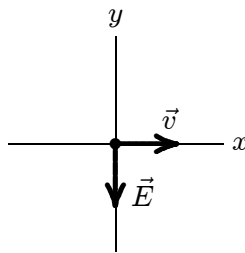

- the positive y direction
- the negative y direction
- into the page
- out of the page
- the negative x direction

ans: C

26. An ion with a charge of $+3.2 \times 10^{-19}$ C is in a region where a uniform electric field of 5×10^4 V/m is perpendicular to a uniform magnetic field of 0.8 T. If its acceleration is zero then its speed must be:
- 0
 - 1.6×10^4 m/s
 - 4.0×10^4 m/s
 - 6.3×10^4 m/s
 - any value but 0

ans: D

27. The current is from left to right in the conductor shown. The magnetic field is into the page and point S is at a higher potential than point T. The charge carriers are:

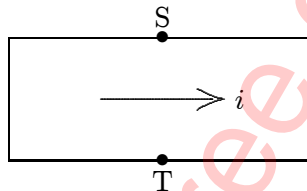

- positive
- negative
- neutral
- absent
- moving near the speed of light

ans: A

28. Electrons (mass m , charge $-e$) are accelerated from rest through a potential difference V and are then deflected by a magnetic field \vec{B} that is perpendicular to their velocity. The radius of the resulting electron trajectory is:

- $(\sqrt{2eV/m})/B$
- $B\sqrt{2eV}/m$
- $(\sqrt{2mV/e})/B$
- $B\sqrt{2mV}/e$
- none of these

ans: C

29. In a certain mass spectrometer, an ion beam passes through a velocity filter consisting of mutually perpendicular fields \vec{E} and \vec{B} . The beam then enters a region of another magnetic field \vec{B}' perpendicular to the beam. The radius of curvature of the resulting ion beam is proportional to:

- EB'/B
- EB/B'
- BB'/E
- B/EB'
- E/BB'

ans: E

30. A cyclotron operates with a given magnetic field and at a given frequency. If R denotes the radius of the final orbit, the final particle energy is proportional to:
- A. $1/R$
 - B. R
 - C. R^2
 - D. R^3
 - E. R^4
- ans: C

31. J. J. Thomson's experiment, involving the motion of an electron beam in mutually perpendicular \vec{E} and \vec{B} fields, gave the value of:
- A. mass of an electron
 - B. charge of an electron
 - C. Earth's magnetic field
 - D. charge/mass ratio for electrons
 - E. Avogadro's number
- ans: D

32. The diagram shows a straight wire carrying a flow of electrons into the page. The wire is between the poles of a permanent magnet. The direction of the magnetic force exerted on the wire is:

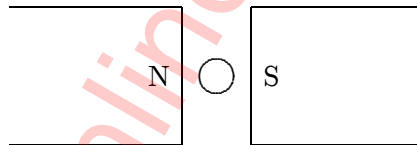

- A. \uparrow
 - B. \downarrow
 - C. \leftarrow
 - D. \rightarrow
 - E. into the page
- ans: A

33. The figure shows the motion of electrons in a wire that is near the N pole of a magnet. The wire will be pushed:

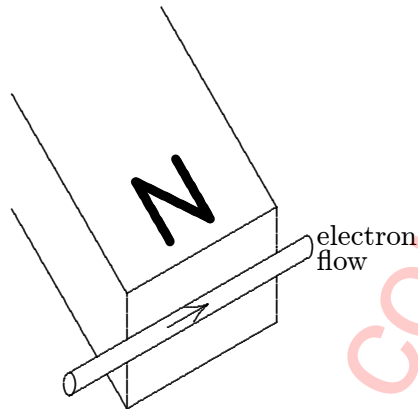

- A. toward the magnet
- B. away from the magnet
- C. downwards
- D. upwards
- E. along its length

ans: D

34. The diagram shows a straight wire carrying current i in a uniform magnetic field. The magnetic force on the wire is indicated by an arrow but the magnetic field is not shown. Of the following possibilities, the direction of the magnetic field is:

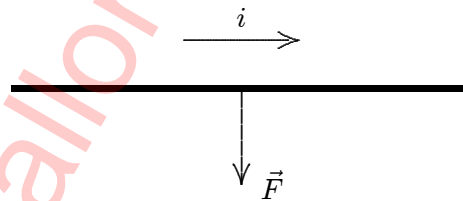

- A. opposite the direction of the current
- B. opposite the direction of \vec{F}
- C. in the direction of \vec{F}
- D. into the page
- E. out of the page

ans: E

35. The figure shows a uniform magnetic field \vec{B} directed to the left and a wire carrying a current into the page. The magnetic force acting on the wire is:

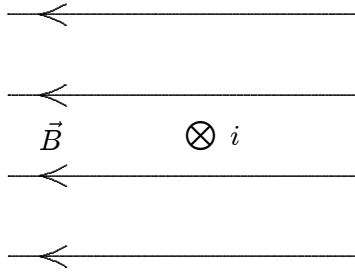

- A. toward the top of the page
B. toward the bottom of the page
C. toward the left
D. toward the right
E. zero
ans: A
36. A loop of wire carrying a current of 2.0 A is in the shape of a right triangle with two equal sides, each 15 cm long. A 0.7 T uniform magnetic field is parallel to the hypotenuse. The resultant magnetic force on the two equal sides has a magnitude of:
A. 0
B. 0.21 N
C. 0.30 N
D. 0.41 N
E. 0.51 N
ans: A
37. A loop of wire carrying a current of 2.0 A is in the shape of a right triangle with two equal sides, each 15 cm long. A 0.7 T uniform magnetic field is in the plane of the triangle and is perpendicular to the hypotenuse. The magnetic force on either of the two equal sides has a magnitude of:
A. zero
B. 0.105 N
C. 0.15 N
D. 0.21 N
E. 0.25 N
ans: C
38. A current is clockwise around the outside edge of this page and a uniform magnetic field is directed parallel to the page, from left to right. If the magnetic force is the only force acting on the page, the page will turn so the right edge:
A. moves toward you
B. moves away from you
C. moves to your right
D. moves to your left
E. does not move
ans: A

39. A square loop of wire lies in the plane of the page and carries a current I as shown. There is a uniform magnetic field \vec{B} parallel to the side MK as indicated. The loop will tend to rotate:

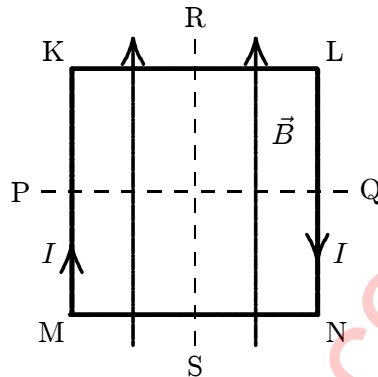

- A. about PQ with KL coming out of the page
 B. about PQ with KL going into the page
 C. about RS with MK coming out of the page
 D. about RS with MK going into the page
 E. about an axis perpendicular to the page.
 ans: A
40. The units of magnetic dipole moment are:
 A. ampere
 B. ampere·meter
 C. ampere·meter²
 D. ampere/meter
 E. ampere/meter²
 ans: C
41. You are facing a loop of wire which carries a clockwise current of 3.0 A and which surrounds an area of $5.8 \times 10^{-2}\text{ m}^2$. The magnetic dipole moment of the loop is:
 A. $3.0\text{ A} \cdot \text{m}^2$, away from you
 B. $3.0\text{ A} \cdot \text{m}^2$, toward you
 C. $0.17\text{ A} \cdot \text{m}^2$, away from you
 D. $0.17\text{ A} \cdot \text{m}^2$, toward you
 E. $0.17\text{ A} \cdot \text{m}^2$, left to right
 ans: C
42. The magnetic torque exerted on a flat current-carrying loop of wire by a uniform magnetic field \vec{B} is:
 A. maximum when the plane of the loop is perpendicular to \vec{B}
 B. maximum when the plane of the loop is parallel to \vec{B}
 C. dependent on the shape of the loop for a fixed loop area
 D. independent of the orientation of the loop
 E. such as to rotate the loop around the magnetic field lines
 ans: B

43. A circular loop of wire with a radius of 20 cm lies in the xy plane and carries a current of 2 A, counterclockwise when viewed from a point on the positive z axis. Its magnetic dipole moment is:
- $0.25 \text{ A} \cdot \text{m}^2$, in the positive z direction
 - $0.25 \text{ A} \cdot \text{m}^2$, in the negative z direction
 - $2.5 \text{ A} \cdot \text{m}^2$, in the positive z direction
 - $2.5 \text{ A} \cdot \text{m}^2$, in the negative z direction
 - $0.25 \text{ A} \cdot \text{m}^2$, in the xy plane

ans: A

44. The diagrams show five possible orientations of a magnetic dipole $\vec{\mu}$ in a uniform magnetic field \vec{B} . For which of these does the magnetic torque on the dipole have the greatest magnitude?

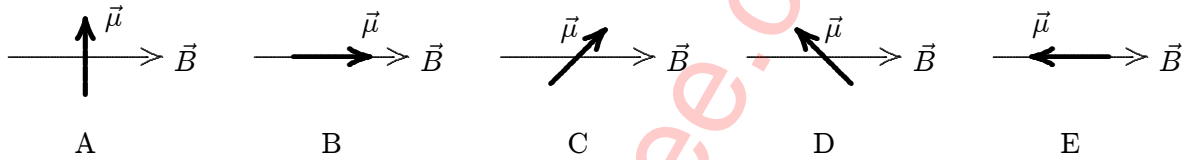

ans: A

45. The magnetic dipole moment of a current-carrying loop of wire is in the positive z direction. If a uniform magnetic field is in the positive x direction the magnetic torque on the loop is:
- 0
 - in the positive y direction
 - in the negative y direction
 - in the positive z direction
 - in the negative z direction

ans: B

46. For a loop of current-carrying wire in a uniform magnetic field the potential energy is a minimum if the magnetic dipole moment of the loop is:
- in the same direction as the field
 - in the direction opposite to that of the field
 - perpendicular to the field
 - at an angle of 45° to the field
 - none of the above

ans: A

47. The diagrams show five possible orientations of a magnetic dipole $\vec{\mu}$ in a uniform magnetic field \vec{B} . For which of these is the potential energy the greatest?

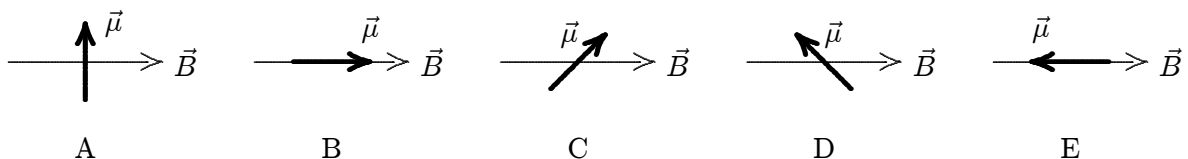

ans: E

48. A loop of current-carrying wire has a magnetic dipole moment of $5 \times 10^{-4} \text{ A} \cdot \text{m}^2$. The moment initially is aligned with a 0.5-T magnetic field. To rotate the loop so its dipole moment is perpendicular to the field and hold it in that orientation, you must do work of:
- A. 0
 - B. $2.5 \times 10^{-4} \text{ J}$
 - C. $-2.5 \times 10^{-4} \text{ J}$
 - D. $1.0 \times 10^{-3} \text{ J}$
 - E. $-1.0 \times 10^{-3} \text{ J}$

ans: B

www.allonlinefree.com

Chapter 29: MAGNETIC FIELDS DUE TO CURRENTS

1. Suitable units for μ_0 are:

- A. tesla
- B. newton/ampere²
- C. weber/meter
- D. kilogram·ampere/meter
- E. tesla·meter/ampere

ans: E

2. A “coulomb” is:

- A. one ampere per second
- B. the quantity of charge that will exert a force of 1 N on a similar charge at a distance of 1 m
- C. the amount of current in each of two long parallel wires, separated by 1 m, that produces a force of 2×10^{-7} N/m
- D. the amount of charge that flows past a point in one second when the current is 1 A
- E. an abbreviation for a certain combination of kilogram, meter and second

ans: D

3. Electrons are going around a circle in a counterclockwise direction as shown. At the center of the circle they produce a magnetic field that is:

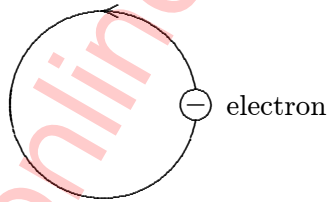

- A. into the page
- B. out of the page
- C. to the left
- D. to the right
- E. zero

ans: A

4. In the figure, the current element $i d\vec{\ell}$, the point P, and the three vectors (1, 2, 3) are all in the plane of the page. The direction of $d\vec{B}$, due to this current element, at the point P is:

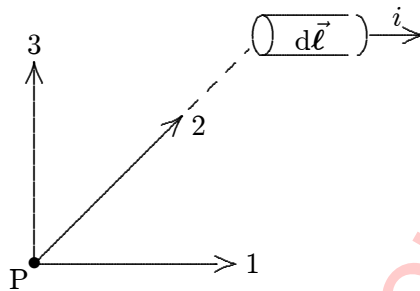

- A. in the direction marked "1"
 B. in the direction marked "2"
 C. in the direction marked "3"
 D. out of the page
 E. into the page

ans: E

5. The magnitude of the magnetic field at point P, at the center of the semicircle shown, is given by:

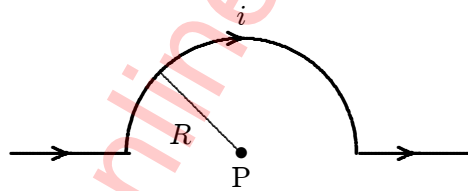

- A. $2\mu_0 i/R$
 B. $\mu_0 i/R$
 C. $\mu_0 i/4\pi R$
 D. $\mu_0 i/2R$
 E. $\mu_0 i/4R$

ans: E

6. The diagrams show three circuits consisting of concentric circular arcs (either half or quarter circles of radii r , $2r$, and $3r$) and radial lengths. The circuits carry the same current. Rank them according to the magnitudes of the magnetic fields they produce at C, least to greatest.

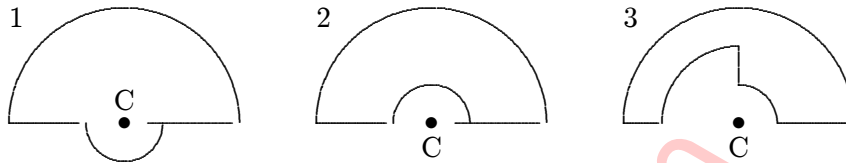

- A. 1, 2, 3
 B. 3, 2, 1
 C. 1, 3, 2
 D. 2, 3, 1
 E. 2, 1, 3

ans: B

7. Lines of the magnetic field produced by a long straight wire carrying a current are:
- A. in the direction of the current
 B. opposite to the direction of the current
 C. radially outward from the wire
 D. radially inward toward the wire
 E. circles that are concentric with the wire

ans: E

8. In an overhead straight wire, the current is north. The magnetic field due to this current, at our point of observation, is:
- A. east
 B. up
 C. north
 D. down
 E. west

ans: E

9. A wire carrying a large current i from east to west is placed over an ordinary magnetic compass. The end of the compass needle marked "N" will point:
- A. north
 B. south
 C. east
 D. west
 E. the compass will act as an electric motor, hence the needle will keep rotating

ans: B

10. The magnetic field outside a long straight current-carrying wire depends on the distance R from the wire axis according to:
- R
 - $1/R$
 - $1/R^2$
 - $1/R^3$
 - $1/R^{3/2}$
- ans: B

11. Which graph correctly gives the magnitude of the magnetic field outside an infinitely long straight current-carrying wire as a function of the distance r from the wire?

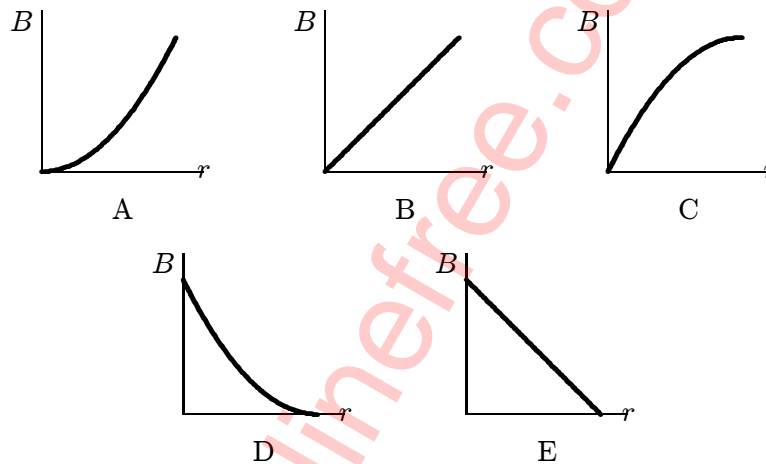

ans: D

12. The magnetic field a distance 2 cm from a long straight current-carrying wire is 2.0×10^{-5} T. The current in the wire is:
- 0.16 A
 - 1.0 A
 - 2.0 A
 - 4.0 A
 - 25 A
- ans: C

13. Two long parallel straight wires carry equal currents in opposite directions. At a point midway between the wires, the magnetic field they produce is:
- zero
 - non-zero and along a line connecting the wires
 - non-zero and parallel to the wires
 - non-zero and perpendicular to the plane of the two wires
 - none of the above
- ans: D

14. Two long straight wires are parallel and carry current in the same direction. The currents are 8.0 and 12 A and the wires are separated by 0.40 cm. The magnetic field in tesla at a point midway between the wires is:
- A. 0
 - B. 4.0×10^{-4}
 - C. 8.0×10^{-4}
 - D. 12×10^{-4}
 - E. 20×10^{-4}

ans: B

15. Two long straight wires are parallel and carry current in opposite directions. The currents are 8.0 and 12 A and the wires are separated by 0.40 cm. The magnetic field in tesla at a point midway between the wires is:
- A. 0
 - B. 4.0×10^{-4}
 - C. 8.0×10^{-4}
 - D. 12×10^{-4}
 - E. 20×10^{-4}

ans: E

16. Two long straight current-carrying parallel wires cross the x axis and carry currents I and $3I$ in the same direction, as shown. At what value of x is the net magnetic field zero?

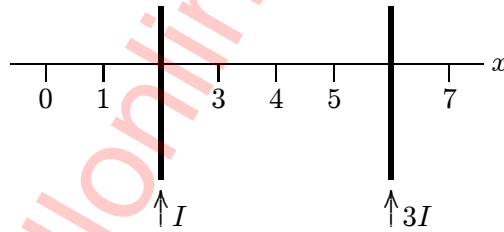

- A. 0
- B. 1
- C. 3
- D. 5
- E. 7

ans: C

17. Two long straight wires pierce the plane of the paper at vertices of an equilateral triangle as shown below. They each carry 2 A, out of the paper. The magnetic field at the third vertex (P) has magnitude (in T):

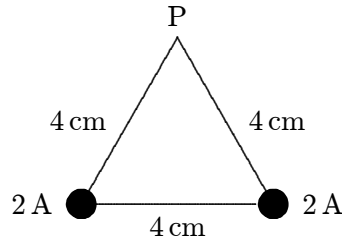

- A. 1.0×10^{-5}
 B. 1.7×10^{-5}
 C. 2.0×10^{-5}
 D. 5.0×10^{-6}
 E. 8.7×10^{-6}

ans: B

18. The diagram shows three equally spaced wires that are perpendicular to the page. The currents are all equal, two being out of the page and one being into the page. Rank the wires according to the magnitudes of the magnetic forces on them, from least to greatest.

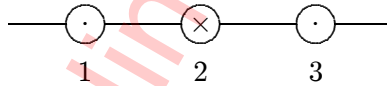

- A. 1, 2, 3
 B. 2, 1 and 3 tie
 C. 2 and 3 tie, then 1
 D. 1 and 3 tie, then 2
 E. 3, 2, 1

ans: B

19. Two parallel wires carrying equal currents of 10 A attract each other with a force of 1 mN. If both currents are doubled, the force of attraction will be:

- A. 1 mN
 B. 4 mN
 C. 0.5 mN
 D. 0.25 mN
 E. 2 mN

ans: B

20. Two parallel long wires carry the same current and repel each other with a force F per unit length. If both these currents are doubled and the wire separation tripled, the force per unit length becomes:
- $2F/9$
 - $4F/9$
 - $2F/3$
 - $4F/3$
 - $6F$

ans: D

21. Two parallel wires, 4 cm apart, carry currents of 2 A and 4 A respectively, in the same direction. The force per unit length in N/m of one wire on the other is:
- 1×10^{-3} , repulsive
 - 1×10^{-3} , attractive
 - 4×10^{-5} , repulsive
 - 4×10^{-5} , attractive
 - none of these

ans: D

22. Two parallel wires, 4 cm apart, carry currents of 2 A and 4 A respectively, in opposite directions. The force per unit length in N/m of one wire on the other is:
- 1×10^{-3} , repulsive
 - 1×10^{-3} , attractive
 - 4×10^{-5} , repulsive
 - 4×10^{-5} , attractive
 - none of these

ans: C

23. Four long straight wires carry equal currents into the page as shown. The magnetic force exerted on wire F is:

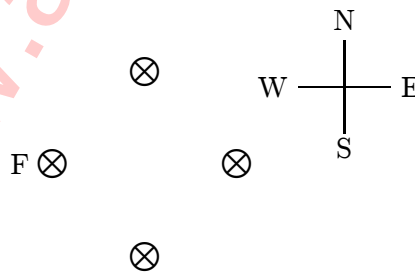

- north
- east
- south
- west
- zero

ans: B

24. A constant current is sent through a helical coil. The coil:
- tends to get shorter
 - tends to get longer
 - tends to rotate about its axis
 - produces zero magnetic field at its center
 - none of the above

ans: A

25. The diagram shows three arrangements of circular loops, centered on vertical axes and carrying identical currents in the directions indicated. Rank the arrangements according to the magnitudes of the magnetic fields at the midpoints between the loops on the central axes.

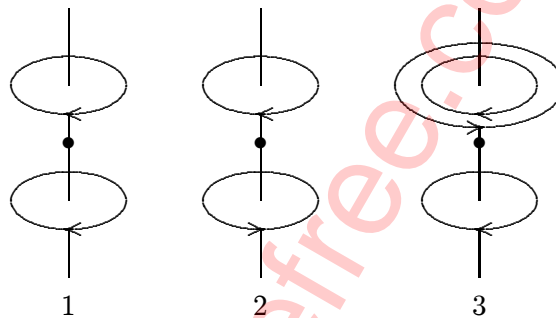

- 1, 2, 3
- 2, 1, 3
- 2, 3, 1
- 3, 2, 1
- 3, 1, 2

ans: C

26. Helmholtz coils are commonly used in the laboratory because the magnetic field between them:
- can be varied more easily than the fields of other current arrangements
 - is especially strong
 - nearly cancels Earth's magnetic field
 - is parallel to the plane of the coils
 - is nearly uniform

ans: E

27. If the radius of a pair of Helmholtz coils is R then the distance between the coils is:

- $R/4$
- $R/2$
- R
- $2R$
- $4R$

ans: C

28. If R is the distance from a magnetic dipole, then the magnetic field it produces is proportional to:
- A. R
 - B. $1/R$
 - C. R^2
 - D. $1/R^2$
 - E. $1/R^3$
- ans: E
29. A square loop of current-carrying wire with edge length a is in the xy plane, the origin being at its center. Along which of the following lines can a charge move without experiencing a magnetic force?
- A. $x = 0, y = a/2$
 - B. $x = a/2, y = a/2$
 - C. $x = a/2, y = 0$
 - D. $x = 0, y = 0$
 - E. $x = 0, z = 0$
- ans: D
30. In Ampere's law, $\oint \vec{B} \cdot d\vec{s} = \mu_0 i$, the integration must be over any:
- A. surface
 - B. closed surface
 - C. path
 - D. closed path
 - E. closed path that surrounds all the current producing \vec{B}
- ans: D
31. In Ampere's law, $\oint \vec{B} \cdot d\vec{s} = \mu_0 i$, the symbol $d\vec{s}$ is:
- A. an infinitesimal piece of the wire that carries current i
 - B. in the direction of \vec{B}
 - C. perpendicular to \vec{B}
 - D. a vector whose magnitude is the length of the wire that carries current i
 - E. none of the above
- ans: E
32. In Ampere's law, $\oint \vec{B} \cdot d\vec{s} = \mu_0 i$, the direction of the integration around the path:
- A. must be clockwise
 - B. must be counterclockwise
 - C. must be such as to follow the magnetic field lines
 - D. must be along the wire in the direction of the current
 - E. none of the above
- ans: E

33. A long straight wire carrying a 3.0 A current enters a room through a window 1.5 m high and 1.0 m wide. The path integral $\oint \vec{B} \cdot d\vec{s}$ around the window frame has the value (in T·m):
- A. 0.20
 - B. 2.5×10^{-7}
 - C. 3.0×10^{-7}
 - D. 3.8×10^{-6}
 - E. none of these
- ans: D
34. Two long straight wires enter a room through a door. One carries a current of 3.0 A into the room while the other carries a current of 5.0 A out. The magnitude of the path integral $\oint \vec{B} \cdot d\vec{s}$ around the door frame is:
- A. $2.5 \times 10^{-6} \text{ T} \cdot \text{m}$
 - B. $3.8 \times 10^{-6} \text{ T} \cdot \text{m}$
 - C. $6.3 \times 10^{-6} \text{ T} \cdot \text{m}$
 - D. $1.0 \times 10^{-5} \text{ T} \cdot \text{m}$
 - E. none of these
- ans: A
35. If the magnetic field \vec{B} is uniform over the area bounded by a circle with radius R , the net current through the circle is:
- A. 0
 - B. $2\pi RB/\mu_0$
 - C. $\pi R^2 B/\mu_0$
 - D. $RB/2\mu_0$
 - E. $2RB/\mu_0$
- ans: A
36. The magnetic field at any point is given by $\vec{B} = A\vec{r} \times \hat{k}$, where \vec{r} is the position vector of the point and A is a constant. The net current through a circle of radius R , in the xy plane and centered at the origin is given by:
- A. $\pi AR^2/\mu_0$
 - B. $2\pi AR/\mu_0$
 - C. $4\pi AR^3/3\mu_0$
 - D. $2\pi AR^2/\mu_0$
 - E. $\pi AR^2/2\mu_0$
- ans: D

37. A hollow cylindrical conductor (inner radius = a , outer radius = b) carries a current i uniformly spread over its cross section. Which graph below correctly gives B as a function of the distance r from the center of the cylinder?

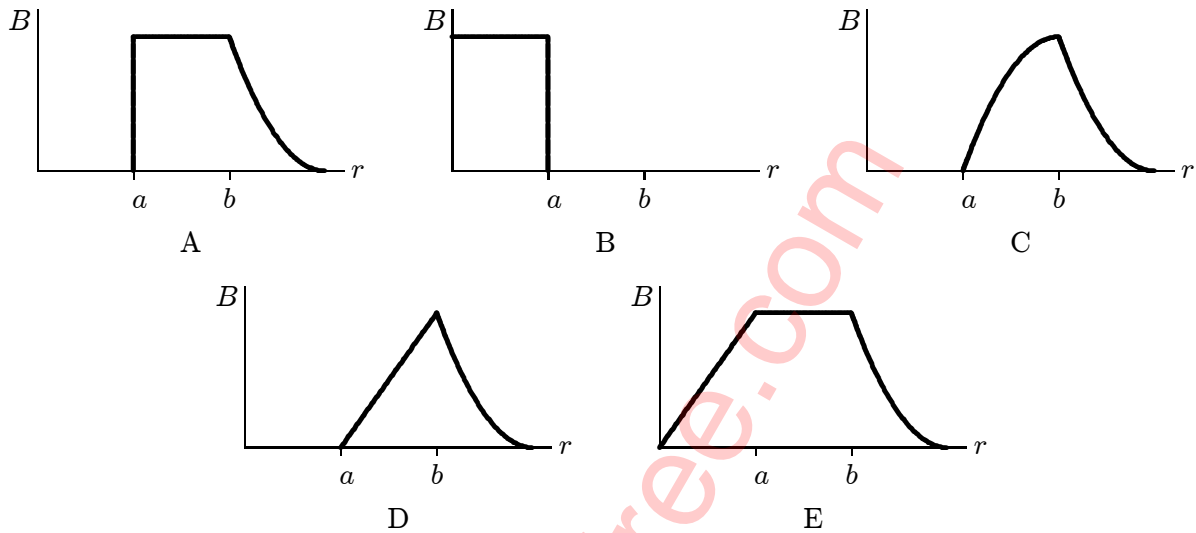

ans: C

38. A long straight cylindrical shell carries current i parallel to its axis and uniformly distributed over its cross section. The magnitude of the magnetic field is greatest:
- at the inner surface of the shell
 - at the outer surface of the shell
 - inside the shell near the middle
 - in hollow region near the inner surface of the shell
 - near the center of the hollow region

ans: B

39. A long straight cylindrical shell has inner radius R_i and outer radius R_o . It carries current i , uniformly distributed over its cross section. A wire is parallel to the cylinder axis, in the hollow region ($r < R_i$). The magnetic field is zero everywhere outside the shell ($r > R_o$). We conclude that the wire:

- is on the cylinder axis and carries current i in the same direction as the current in the shell
- may be anywhere in the hollow region but must be carrying current i in the direction opposite to that of the current in the shell
- may be anywhere in the hollow region but must be carrying current i in the same direction as the current in the shell
- is on the cylinder axis and carries current i in the direction opposite to that of the current in the shell
- does not carry any current

ans: D

40. A long straight cylindrical shell has inner radius R_i and outer radius R_o . It carries a current i , uniformly distributed over its cross section. A wire is parallel to the cylinder axis, in the hollow region ($r < R_i$). The magnetic field is zero everywhere in the hollow region. We conclude that the wire:
- is on the cylinder axis and carries current i in the same direction as the current in the shell
 - may be anywhere in the hollow region but must be carrying current i in the direction opposite to that of the current in the shell
 - may be anywhere in the hollow region but must be carrying current i in the same direction as the current in the shell
 - is on the cylinder axis and carries current i in the direction opposite to that of the current in the shell
 - does not carry any current

ans: E

41. The magnetic field B inside a long ideal solenoid is independent of:
- the current
 - the core material
 - the spacing of the windings
 - the cross-sectional area of the solenoid
 - the direction of the current

ans: D

42. Two long ideal solenoids (with radii 20 mm and 30 mm, respectively) have the same number of turns of wire per unit length. The smaller solenoid is mounted inside the larger, along a common axis. The magnetic field within the inner solenoid is zero. The current in the inner solenoid must be:
- two-thirds the current in the outer solenoid
 - one-third the current in the outer solenoid
 - twice the current in the outer solenoid
 - half the current in the outer solenoid
 - the same as the current in the outer solenoid

ans: E

43. Magnetic field lines inside the solenoid shown are:

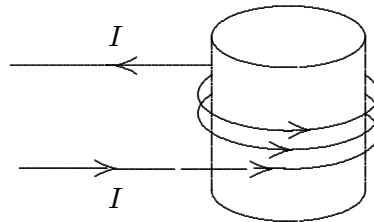

- clockwise circles as one looks down the axis from the top of the page
- counterclockwise circles as one looks down the axis from the top of the page
- toward the top of the page
- toward the bottom of the page
- in no direction since $B = 0$

ans: C

44. Solenoid 2 has twice the radius and six times the number of turns per unit length as solenoid 1. The ratio of the magnetic field in the interior of 2 to that in the interior of 1 is:
- A. 2
 - B. 4
 - C. 6
 - D. 1
 - E. 1/3
- ans: C
45. A solenoid is 3.0 cm long and has a radius of 0.50 cm. It is wrapped with 500 turns of wire carrying a current of 2.0 A. The magnetic field at the center of the solenoid is:
- A. 9.9×10^{-8} T
 - B. 1.3×10^{-3} T
 - C. 4.2×10^{-2} T
 - D. 16 T
 - E. 20 T
- ans: C
46. A toroid with a square cross section carries current i . The magnetic field has its largest magnitude:
- A. at the center of the hole
 - B. just inside the toroid at its inner surface
 - C. just inside the toroid at its outer surface
 - D. at any point inside (the field is uniform)
 - E. none of the above
- ans: B
47. A toroid has a square cross section with the length of an edge equal to the radius of the inner surface. The ratio of the magnitude of the magnetic field at the inner surface to the magnitude of the field at the outer surface is:
- A. 1/4
 - B. 1/2
 - C. 1
 - D. 2
 - E. 4
- ans: D

Chapter 30: INDUCTION AND INDUCTANCE

1. The normal to a certain 1-m^2 area makes an angle of 60° with a uniform magnetic field. The magnetic flux through this area is the same as the flux through a second area that is perpendicular to the field if the second area is:
- A. 0.866 m^2
 - B. 1.15 m^2
 - C. 0.5 m^2
 - D. 2 m^2
 - E. 1 m^2

ans: C

2. Suppose this page is perpendicular to a uniform magnetic field and the magnetic flux through it is 5 Wb . If the page is turned by 30° around an edge the flux through it will be:
- A. 2.5 Wb
 - B. 4.3 Wb
 - C. 5 Wb
 - D. 5.8 Wb
 - E. 10 Wb

ans: B

3. A 2-T uniform magnetic field makes an angle of 30° with the z axis. The magnetic flux through a 3-m^2 portion of the xy plane is:
- A. 2.0 Wb
 - B. 3.0 Wb
 - C. 5.2 Wb
 - D. 6.0 Wb
 - E. 12 Wb

ans: C

4. A uniform magnetic field makes an angle of 30° with the z axis. If the magnetic flux through a 1-m^2 portion of the xy plane is 5 Wb then the magnetic flux through a 2-m^2 portion of the same plane is:
- A. 2.5 Wb
 - B. 4.3 Wb
 - C. 5 Wb
 - D. 5.8 Wb
 - E. 10 Wb

ans: E

5. 1 weber is the same as:

- A. 1 V/s
- B. 1 T/s
- C. 1 T/m
- D. $1\text{ T}\cdot\text{m}^2$
- E. 1 T/m^2

ans: D

6. 1 weber is the same as:

- A. $1 \text{ V} \cdot \text{s}$
- B. $1 \text{ T} \cdot \text{s}$
- C. 1 T/m
- D. 1 V/s
- E. 1 T/m^2

ans: A

7. The units of motional emf are:

- A. volt/second
- B. volt·meter/second
- C. volt/tesla
- D. tesla/second
- E. tesla·meter²/second

ans: E

8. Faraday's law states that an induced emf is proportional to:

- A. the rate of change of the magnetic field
- B. the rate of change of the electric field
- C. the rate of change of the magnetic flux
- D. the rate of change of the electric flux
- E. zero

ans: C

9. The emf that appears in Faraday's law is:

- A. around a conducting circuit
- B. around the boundary of the surface used to compute the magnetic flux
- C. throughout the surface used to compute the magnetic flux
- D. perpendicular to the surface used to compute the magnetic flux
- E. none of the above

ans: B

10. If the magnetic flux through a certain region is changing with time:

- A. energy must be dissipated as heat
- B. an electric field must exist at the boundary
- C. a current must flow around the boundary
- D. an emf must exist around the boundary
- E. a magnetic field must exist at the boundary

ans: D

11. A square loop of wire lies in the plane of the page. A decreasing magnetic field is directed into the page. The induced current in the loop is:
- A. counterclockwise
 - B. clockwise
 - C. zero
 - D. up the left edge and from right to left along the top edge
 - E. through the middle of the page

ans: B

12. As an externally generated magnetic field through a certain conducting loop increases in magnitude, the field produced at points inside the loop by the current induced in the loop must be:
- A. increasing in magnitude
 - B. decreasing in magnitude
 - C. in the same direction as the applied field
 - D. directed opposite to the applied field
 - E. perpendicular to the applied field

ans: D

13. At any instant of time the total magnetic flux through a stationary conducting loop is less in magnitude than the flux associated with an externally applied field. This might occur because:
- A. the applied field is normal to the loop and increasing in magnitude
 - B. the applied field is normal to the loop and decreasing in magnitude
 - C. the applied field is parallel to the plane of the loop and increasing in magnitude
 - D. the applied field is parallel to the plane of the loop and decreasing in magnitude
 - E. the applied field is tangent to the loop

ans: A

14. A long straight wire is in the plane of a rectangular conducting loop. The straight wire carries a constant current i , as shown. While the wire is being moved toward the rectangle the current in the rectangle is:

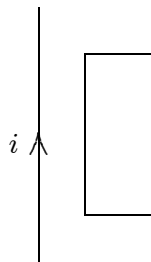

- A. zero
- B. clockwise
- C. counterclockwise
- D. clockwise in the left side and counterclockwise in the right side
- E. counterclockwise in the left side and clockwise in the right side

ans: C

15. A long straight wire is in the plane of a rectangular conducting loop. The straight wire carries an increasing current in the direction shown. The current in the rectangle is:

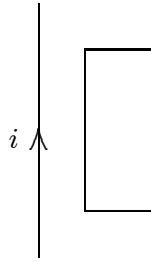

- A. zero
- B. clockwise
- C. counterclockwise
- D. clockwise in the left side and counterclockwise in the right side
- E. counterclockwise in the left side and clockwise in the right side

ans: C

16. A long straight wire is in the plane of a rectangular conducting loop. The straight wire initially carries a constant current i in the direction shown. While the current i is being shut off, the current in the rectangle is:

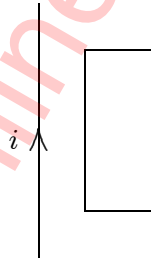

- A. zero
- B. clockwise
- C. counterclockwise
- D. clockwise in the left side and counterclockwise in the right side
- E. counterclockwise in the left side and clockwise in the right side

ans: B

17. A rectangular loop of wire is placed midway between two long straight parallel conductors as shown. The conductors carry currents i_1 and i_2 , as indicated. If i_1 is increasing and i_2 is constant, then the induced current in the loop is:

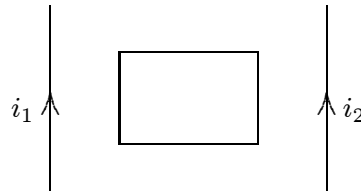

- A. zero
 B. clockwise
 C. counterclockwise
 D. depends on $i_1 - i_2$
 E. depends on $i_1 + i_2$
 ans: C
18. You push a permanent magnet with its north pole away from you toward a loop of conducting wire in front of you. Before the north pole enters the loop the current in the loop is:
 A. zero
 B. clockwise
 C. counterclockwise
 D. to your left
 E. to your right
 ans: C
19. A vertical bar magnet is dropped through the center of a horizontal loop of wire, with its north pole leading. At the instant when the midpoint of the magnet is in the plane of the loop, the induced current at point P, viewed from above, is:
 A. maximum and clockwise
 B. maximum and counterclockwise
 C. not maximum but clockwise
 D. not maximum but counterclockwise
 E. essentially zero
 ans: E
20. A circular loop of wire rotates about a diameter in a magnetic field that is perpendicular to the axis of rotation. Looking in the direction of the field at the loop the induced current is:
 A. always clockwise
 B. always counterclockwise
 C. clockwise in the lower half of the loop and counterclockwise in the upper half
 D. clockwise in the upper half of the loop and counterclockwise in the lower half
 E. sometimes clockwise and sometimes counterclockwise
 ans: E

21. In the experiment shown:

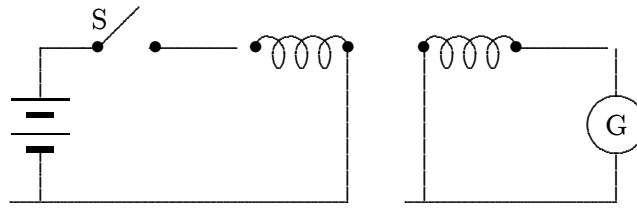

- A. there is a steady reading in G as long as S is closed
- B. a motional emf is generated when S is closed
- C. the current in the battery goes through G
- D. there is a current in G just after S is opened or closed
- E. since the two loops are not connected, the current in G is always zero

ans: D

22. The emf developed in a coil X due to the current in a neighboring coil Y is proportional to the:

- A. magnetic field in X
- B. rate of change of magnetic field in X
- C. resistance of X
- D. thickness of the wire in X
- E. current in Y

ans: B

23. One hundred turns of insulated copper wire are wrapped around an iron core of cross-sectional area 0.100 m^2 . The circuit is completed by connecting the coil to a $10\text{-}\Omega$ resistor. As the magnetic field along the coil axis changes from 1.00 T in one direction to 1.00 T in the other direction, the total charge that flows through the resistor is:

- A. 10^{-2} C
- B. $2 \times 10^{-2}\text{ C}$
- C. 1 C
- D. 2 C
- E. 0.20 C

ans: D

24. In the circuit shown, there will be a non-zero reading in galvanometer G:

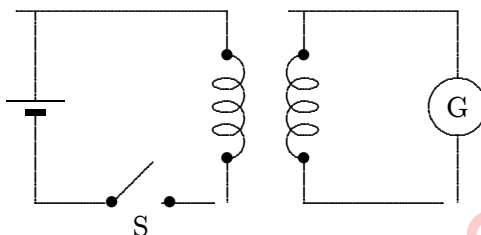

- A. only just after S is closed
 B. only just after S is opened
 C. only while S is kept closed
 D. never
 E. only just after S is opened or closed

ans: E

25. A magnet moves inside a coil. Consider the following factors:

- I. strength of the magnet
 II. number of turns in the coil
 III. speed at which the magnet moves

Which can affect the emf induced in the coil?

- A. I only
 B. II only
 C. III only
 D. I and II only
 E. I, II, III

ans: E

26. The graph shows the magnitude B of a uniform magnetic field that is perpendicular to the plane of a conducting loop. Rank the five regions indicated on the graph according to the magnitude of the emf induced in the loop, from least to greatest.

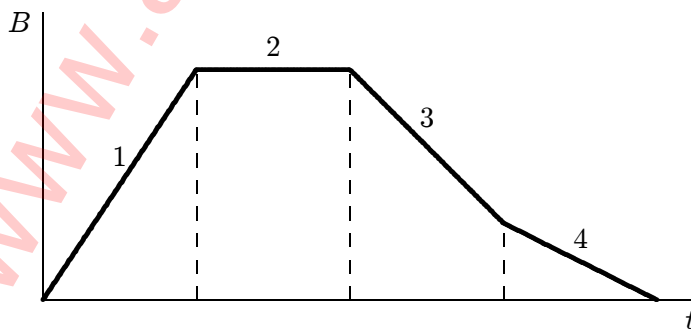

- A. 1, 2, 3, 4
 B. 2, 4, 3, 1
 C. 4, 3, 1, 2
 D. 1, 3, 4, 2
 E. 4, 3, 2, 1

ans: B

27. The circuit shown is in a uniform magnetic field that is into the page. The current in the circuit is 0.20 A. At what rate is the magnitude of the magnetic field changing? Is it increasing or decreasing?:

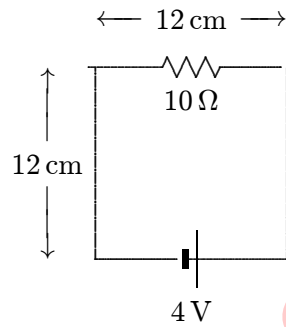

- A. zero
 B. 140 T/s, decreasing
 C. 140 T/s, increasing
 D. 420 T/s, decreasing
 E. 420 T/s, increasing

ans: B

28. A changing magnetic field pierces the interior of a circuit containing three identical resistors. Two voltmeters are connected to the same points, as shown. V_1 reads 1 mV. V_2 reads:

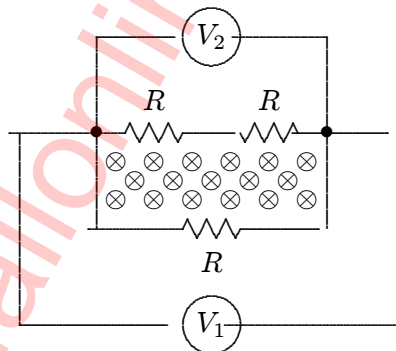

- A. 0
 B. $1/3$ mV
 C. $1/2$ mV
 D. 1 mV
 E. 2 mV

ans: E

29. A circular loop of wire is positioned half in and half out of a square region of constant uniform magnetic field directed into the page, as shown. To induce a clockwise current in this loop:

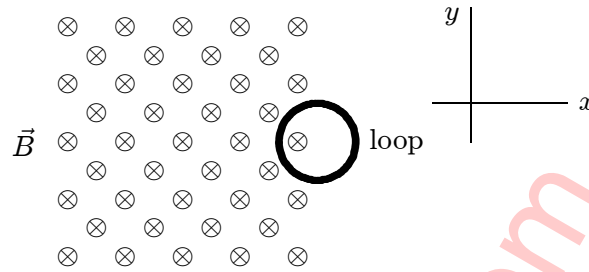

- A. move it in $+x$ direction
 B. move it in $+y$ direction
 C. move it in $-y$ direction
 D. move it in $-x$ direction
 E. increase the strength of the magnetic field
- ans: A
30. The four wire loops shown have edge lengths of either L , $2L$, or $3L$. They will move with the same speed into a region of uniform magnetic field \vec{B} , directed out of the page. Rank them according to the maximum magnitude of the induced emf, least to greatest.

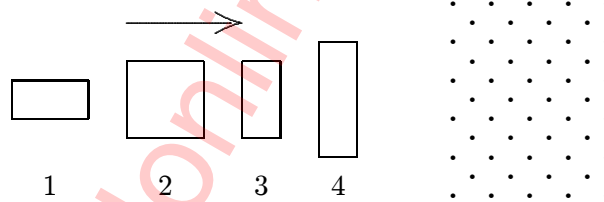

- A. 1 and 2 tie, then 3 and 4 tie
 B. 3 and 4 tie, then 1 and 2 tie
 C. 4, 2, 3, 1
 D. 1, then 2 and 3 tie, then 4
 E. 1, 2, 3, 4
- ans: D

31. A square loop of wire moves with a constant speed v from a field-free region into a region of constant uniform magnetic field, as shown. Which of the five graphs correctly shows the induced current i in the loop as a function of time t ?

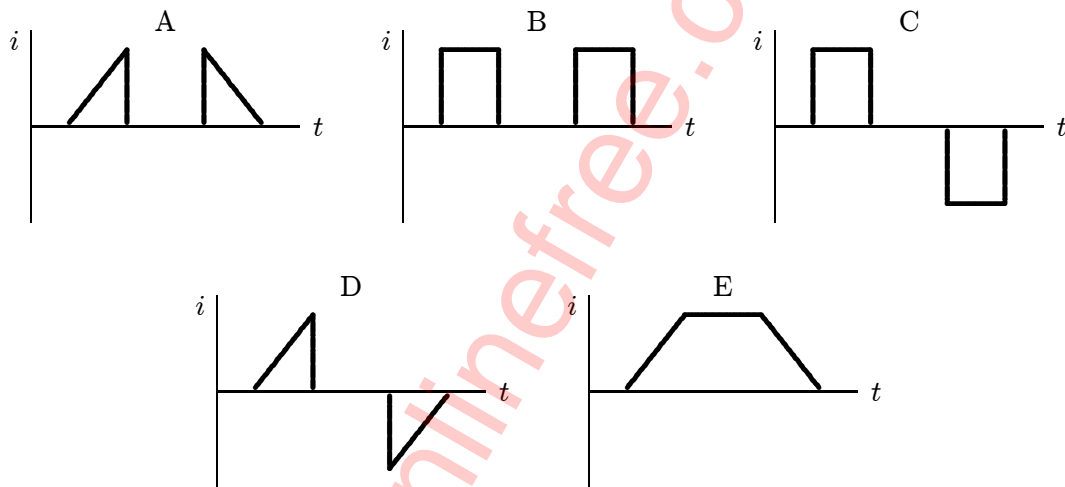
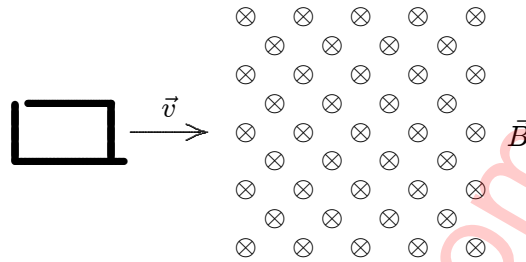

ans: C

32. The figure shows a bar moving to the right on two conducting rails. To make an induced current i in the direction indicated, a constant magnetic field in region A should be in what direction?

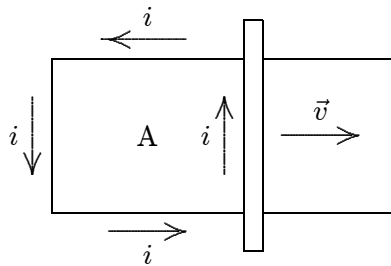

- A. Right
- B. Left
- C. Into the page
- D. Out of the page
- E. Impossible; this cannot be done with a constant magnetic field

ans: C

33. A car travels northward at 75 km/h along a straight road in a region where Earth's magnetic field has a vertical component of 0.50×10^{-4} T. The emf induced between the left and right side, separated by 1.7 m, is:
- A. 0
 - B. 1.8 mV
 - C. 3.6 mV
 - D. 6.4 mV
 - E. 13 mV
- ans: B

34. Coils P and Q each have a large number of turns of insulated wire. When switch S is closed, the pointer of galvanometer G is deflected toward the left. With S now closed, to make the pointer of G deflect toward the right one could:

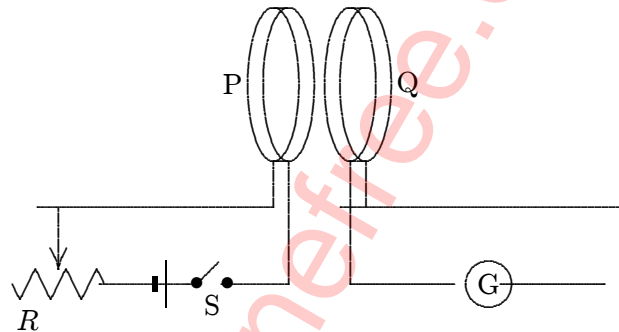

- A. move the slide of the rheostat R quickly to the right
 - B. move coil P toward coil Q
 - C. move coil Q toward coil P
 - D. open S
 - E. do none of the above
- ans: D
35. A rod lies across frictionless rails in a constant uniform magnetic field \vec{B} , as shown. The rod moves to the right with speed v . In order for the emf around the circuit to be zero, the magnitude of the magnetic field should:

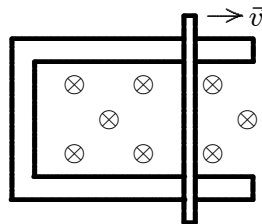

- A. not change
 - B. increase linearly with time
 - C. decrease linearly with time
 - D. increase quadratically with time
 - E. decrease quadratically with time
- ans: C

36. A rectangular loop of wire has area A . It is placed perpendicular to a uniform magnetic field B and then spun around one of its sides at frequency f . The maximum induced emf is:
- BAf
 - BA^2f
 - $2BAf$
 - $2\pi BAf$
 - $4\pi BAf$
- ans: D

37. A rectangular loop of wire is placed perpendicular to a uniform magnetic field and then spun around one of its sides at frequency f . The induced emf is a maximum when:
- the flux is zero
 - the flux is a maximum
 - the flux is half its maximum value
 - the derivative of the flux with respect to time is zero
 - none of the above
- ans: A

38. The diagram shows a circular loop of wire that rotates at a steady rate about a diameter O that is perpendicular to a uniform magnetic field. The maximum induced emf occurs when the point X on the loop passes:

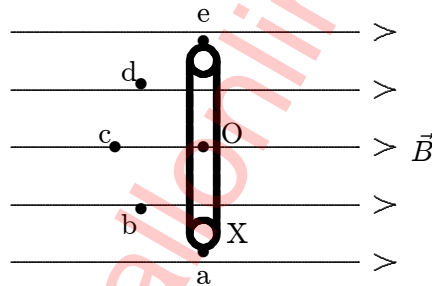

- a
 - b
 - c
 - d
 - e
- ans: C

39. A copper hoop is held in a vertical east-west plane in a uniform magnetic field whose field lines run along the north-south direction. The largest induced emf is produced when the hoop is:
- rotated about a north-south axis
 - rotated about an east-west axis
 - moved rapidly, without rotation, toward the east
 - moved rapidly, without rotation, toward the south
 - moved rapidly, without rotation, toward the northwest
- ans: B

40. A 10-turn conducting loop with a radius of 3.0 cm spins at 60 revolutions per second in a magnetic field of 0.50 T. The maximum emf generated is:
- A. 0.014 V
 - B. 0.53 V
 - C. 5.3 V
 - D. 18 V
 - E. 180 V
- ans: C
41. A single loop of wire with a radius of 7.5 cm rotates about a diameter in a uniform magnetic field of 1.6 T. To produce a maximum emf of 1.0 V, it should rotate at:
- A. 0
 - B. 2.7 rad/s
 - C. 5.6 rad/s
 - D. 35 rad/s
 - E. 71 rad/s
- ans: D
42. A merry-go-round has an area of 300 m^2 and spins at 2 rpm about a vertical axis at a place where Earth's magnetic field is vertical and has a magnitude of $5 \times 10^{-5} \text{ T}$. The emf around the rim is:
- A. 0
 - B. 0.5 mV
 - C. 3.1 mV
 - D. 15 mV
 - E. 30 mV
- ans: A

43. A copper penny slides on a horizontal frictionless table. There is a square region of constant uniform magnetic field perpendicular to the table, as shown. Which graph correctly shows the speed v of the penny as a function of time t ?

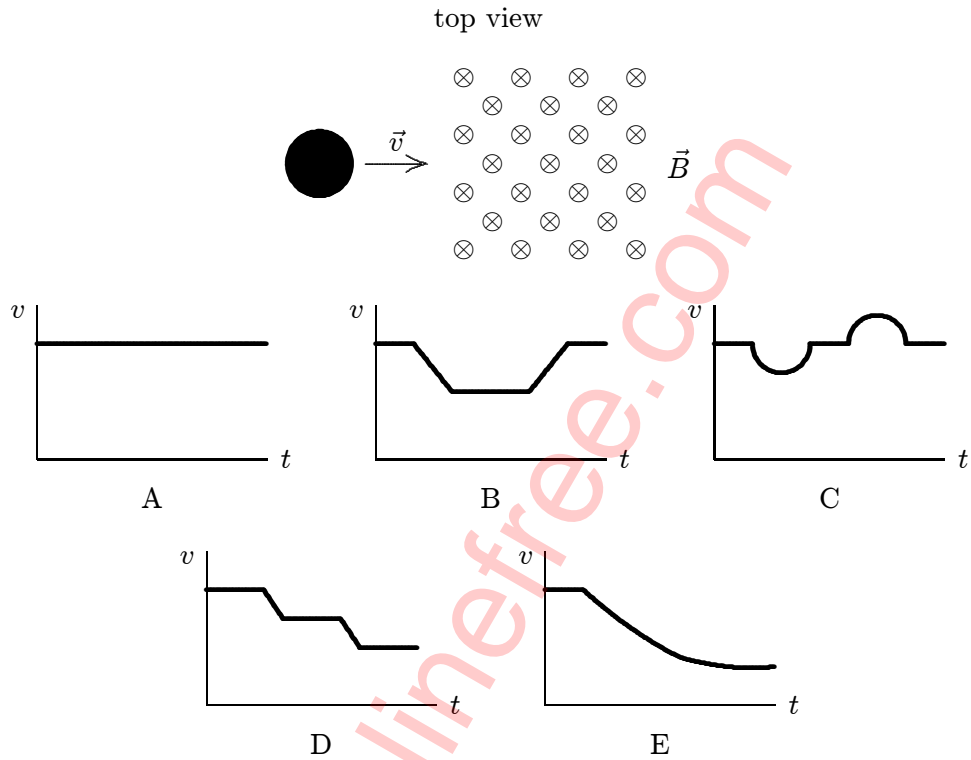

ans: D

44. A rod with resistance R lies across frictionless conducting rails in a constant uniform magnetic field \vec{B} , as shown. Assume the rails have negligible resistance. The magnitude of the force that must be applied by a person to pull the rod to the right at constant speed v is:

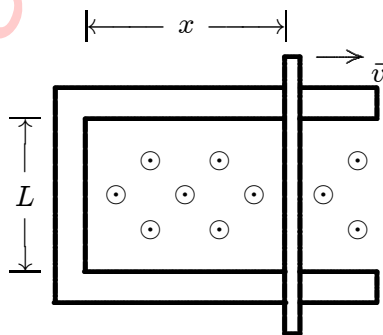

- A. 0
 B. BLv
 C. BLv/R
 D. B^2L^2v/R
 E. B^2Lxv/R

ans: D

45. A rod of length L and electrical resistance R moves through a constant uniform magnetic field \vec{B} , perpendicular to the rod. The force that must be applied by a person to keep the rod moving with constant velocity \vec{v} is:
- A. 0
 - B. BLv
 - C. BLv/R
 - D. B^2L^2v/R
 - E. $B^2L^2v^2/R$
- ans: A
46. As a loop of wire with a resistance of $10\ \Omega$ moves in a constant non-uniform magnetic field, it loses kinetic energy at a uniform rate of $4.0\ \text{mJ/s}$. The induced current in the loop:
- A. is 0
 - B. is $2\ \text{mA}$
 - C. is $2.8\ \text{mA}$
 - D. is $20\ \text{mA}$
 - E. cannot be calculated from the given data
- ans: D
47. As a loop of wire with a resistance of $10\ \Omega$ moves in a non-uniform magnetic field, it loses kinetic energy at a uniform rate of $5\ \text{mJ/s}$. The induced emf in the loop:
- A. is 0
 - B. is $0.2\ \text{V}$
 - C. is $0.28\ \text{V}$
 - D. is $2\ \text{V}$
 - E. cannot be calculated from the given data
- ans: B
48. An electric field is associated with every:
- A. magnetic field
 - B. time-dependent magnetic field
 - C. time-dependent magnetic flux
 - D. object moving in a magnetic field
 - E. conductor moving in a magnetic field
- ans: B
49. A cylindrical region of radius $R = 3.0\ \text{cm}$ contains a uniform magnetic field parallel to its axis. If the electric field induced at a point $R/2$ from the cylinder axis is $4.5 \times 10^{-3}\ \text{V/m}$ the magnitude of the magnetic field must be changing at the rate:
- A. 0
 - B. $0.30\ \text{T/s}$
 - C. $0.60\ \text{T/s}$
 - D. $1.2\ \text{T/s}$
 - E. $2.4\ \text{T/s}$
- ans: C

50. A cylindrical region of radius R contains a uniform magnetic field parallel to its axis. The field is zero outside the cylinder. If the magnitude of the field is changing at the rate dB/dt , the electric field induced at a point $2R$ from the cylinder axis is:
- A. zero
 - B. $2R dB/dt$
 - C. $R dB/dt$
 - D. $(R/2) dB/dt$
 - E. $(R/4) dB/dt$
- ans: E
51. A cylindrical region of radius R contains a uniform magnetic field, parallel to its axis, with magnitude that is changing linearly with time. If r is the radial distance from the cylinder axis, the magnitude of the induced electric field inside the cylinder is proportional to:
- A. R
 - B. r
 - C. r^2
 - D. $1/r$
 - E. $1/r^2$
- ans: B
52. A cylindrical region of radius R contains a uniform magnetic field, parallel to its axis, with magnitude that is changing linearly with time. If r is the radial distance from the cylinder axis, the magnitude of the induced electric field outside the cylinder is proportional to:
- A. R
 - B. r
 - C. r^2
 - D. $1/r$
 - E. $1/r^2$
- ans: D
53. The unit “henry” is equivalent to:
- A. volt·second/ampere
 - B. volt/second
 - C. ohm
 - D. ampere·volt/second
 - E. ampere·second/volt
- ans: A

54. The diagram shows an inductor that is part of a circuit. The direction of the emf induced in the inductor is indicated. Which of the following is possible?

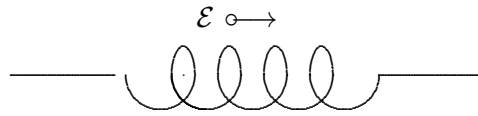

- A. The current is constant and rightward
 B. The current is constant and leftward
 C. The current is increasing and rightward
 D. The current is increasing and leftward
 E. None of the above
 ans: D
55. A 10-turn ideal solenoid has an inductance of 3.5 mH. When the solenoid carries a current of 2.0 A the magnetic flux through each turn is:
 A. 0
 B. 3.5×10^{-4} wb
 C. 7.0×10^{-4} wb
 D. 7.0×10^{-3} wb
 E. 7.0×10^{-2} wb
 ans : C
56. A 10-turn ideal solenoid has an inductance of 4.0 mH. To generate an emf of 2.0 V the current should change at a rate of:
 A. zero
 B. 5.0 A/s
 C. 50 A/s
 D. 250 A/s
 E. 500 A/s
 ans: E
57. A long narrow solenoid has length ℓ and a total of N turns, each of which has cross-sectional area A . Its inductance is:
 A. $\mu_0 N^2 A \ell$
 B. $\mu_0 N^2 A / \ell$
 C. $\mu_0 N A / \ell$
 D. $\mu_0 N^2 \ell / A$
 E. none of these
 ans: B

58. A flat coil of wire, having 5 turns, has an inductance L . The inductance of a similar coil having 20 turns is:
- A. $4L$
 - B. $L/4$
 - C. $16L$
 - D. $L/16$
 - E. L

ans: C

59. An inductance L , resistance R , and ideal battery of emf \mathcal{E} are wired in series. A switch in the circuit is closed at time 0, at which time the current is zero. At any later time t the current i is given by:

- A. $(\mathcal{E}/R)(1 - e^{-Lt/R})$
- B. $(\mathcal{E}/R)e^{-Lt/R}$
- C. $(\mathcal{E}/R)(1 + e^{-Rt/L})$
- D. $(\mathcal{E}/R)e^{-Rt/L}$
- E. $(\mathcal{E}/R)(1 - e^{-Rt/L})$

ans: E

60. An inductance L , resistance R , and ideal battery of emf \mathcal{E} are wired in series. A switch in the circuit is closed at time 0, at which time the current is zero. At any later time t the emf of the inductor is given by:

- A. $\mathcal{E}(1 - e^{-Lt/R})$
- B. $\mathcal{E}e^{-Lt/R}$
- C. $\mathcal{E}(1 + e^{-Rt/L})$
- D. $\mathcal{E}e^{-Rt/L}$
- E. $\mathcal{E}(1 - e^{-Rt/L})$

ans: D

61. An inductance L , resistance R , and ideal battery of emf \mathcal{E} are wired in series. A switch in the circuit is closed at time 0, at which time the current is zero. At any later time t the potential difference across the resistor is given by:

- A. $\mathcal{E}(1 - e^{-Lt/R})$
- B. $\mathcal{E}e^{-Lt/R}$
- C. $\mathcal{E}(1 + e^{-Rt/L})$
- D. $\mathcal{E}e^{-Rt/L}$
- E. $\mathcal{E}(1 - e^{-Rt/L})$

ans: E

62. An 8.0-mH inductor and a 2.0- Ω resistor are wired in series to an ideal battery. A switch in the circuit is closed at time 0, at which time the current is zero. The current reaches half its final value at time:

- A. 2.8 ms
- B. 4.0 ms
- C. 3 s
- D. 170 s
- E. 250 s

ans: A

63. An 8.0-mH inductor and a 2.0- Ω resistor are wired in series to a 20-V ideal battery. A switch in the circuit is closed at time 0, at which time the current is zero. After a long time the current in the resistor and the current in the inductor are:
- A. 0, 0
 - B. 10 A, 10 A
 - C. 2.5 A, 2.5 A
 - D. 10 A, 2.5 A
 - E. 10 A, 0
- ans: B
64. An 8.0-mH inductor and a 2.0- Ω resistor are wired in series to a 20-V ideal battery. A switch in the circuit is closed at time 0, at which time the current is zero. Immediately after the switch is thrown the potential differences across the inductor and resistor are:
- A. 0, 20 V
 - B. 20 V, 0
 - C. 10 V, 10 V
 - D. 16 V, 4 V
 - E. unknown since the rate of change of the current is not given
- ans: B
65. An inductor with inductance L resistor with resistance R are wired in series to an ideal battery with emf \mathcal{E} . A switch in the circuit is closed at time 0, at which time the current is zero. A long time after the switch is thrown the potential differences across the inductor and resistor:
- A. 0, \mathcal{E}
 - B. \mathcal{E} , 0
 - C. $\mathcal{E}/2$, $\mathcal{E}/2$
 - D. $(L/R)\mathcal{E}$, $(R/L)\mathcal{E}$
 - E. cannot be computed unless the rate of change of the current is given
- ans: A
66. If both the resistance and the inductance in an LR series circuit are doubled the new inductive time constant will be:
- A. twice the old
 - B. four times the old
 - C. half the old
 - D. one-fourth the old
 - E. unchanged
- ans: E

67. When the switch S in the circuit shown is closed, the time constant for the growth of current in R_2 is:

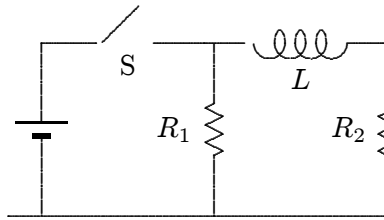

- A. L/R_1
 B. L/R_2
 C. $L/(R_1 + R_2)$
 D. $L(R_1 + R_2)/(R_1 R_2)$
 E. $(L/R_1 + L/R_2)/2$

ans: B

68. The diagrams show three circuits with identical batteries, identical inductors, and identical resistors. Rank them according to the current through the battery just after the switch is closed, from least to greatest.

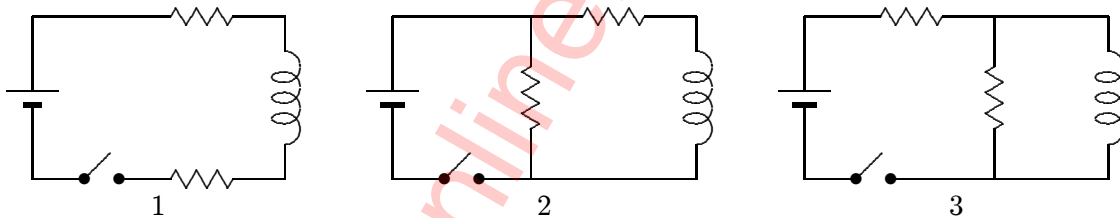

- A. 3, 2, 1
 B. 2 and 3 ties, then 1
 C. 1, 3, 2
 D. 1, 2, 3
 E. 3, 1, 2

ans: C

69. Immediately after switch S in the circuit shown is closed, the current through the battery is:

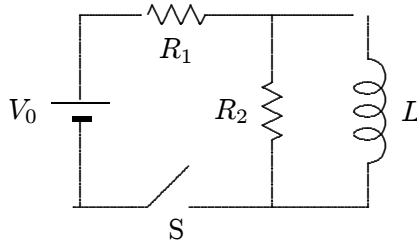

- A. 0
B. V_0/R_1
C. V_0/R_2
D. $V_0/(R_1 + R_2)$
E. $V_0(R_1 + R_2)/(R_1R_2)$
ans: D
70. A 3.5-mH inductor and a 4.5-mH inductor are connected in series. The equivalent inductance is:
A. 2.0 mH
B. 0.51 mH
C. 0.13 mH
D. 1.0 mH
E. 8.0 mH
ans: E
71. A 3.5-mH inductor and a 4.5-mH inductor are connected in series and a time varying current is established in them. When the total emf of the combination is 16 V, the emf of the larger inductor is:
A. 7.0 V
B. 9.0 V
C. 2.3 V
D. 28 V
E. 36 V
ans: B
72. A 3.5-mH inductor and a 4.5-mH inductor are connected in parallel. The equivalent inductance is:
A. 2.0 mH
B. 0.51 mH
C. 0.13 mH
D. 1.0 mH
E. 8.0 mH
ans: A

73. A 3.5-mH inductor and a 4.5-mH inductor are connected in parallel. When the total emf of the combination is 16 V, the rate of change of the current in the larger inductor is:
- A. 2.0×10^3 A/s
 - B. 3.6×10^3 A/s
 - C. 4.6×10^3 A/s
 - D. 7.0×10^3 A/s
 - E. 8.1×10^3 A/s
- ans: B
74. An inductor with inductance L and an inductor with inductance $2L$ are connected in parallel. When the rate of change of the current in the larger inductor is 1200 A/s the rate of change of the current in the smaller inductor is:
- A. 400 A/s
 - B. 1200 A/s
 - C. 1600 A/s
 - D. 2000 A/s
 - E. 2400 A/s
- ans: E
75. The stored energy in an inductor:
- A. depends, in sign, upon the direction of the current
 - B. depends on the rate of change of current
 - C. is proportional to the square of the inductance
 - D. has units J/H
 - E. none of the above
- ans: E
76. An inductance L and a resistance R are connected in series to an ideal battery. A switch in the circuit is closed at time 0, at which time the current is zero. The energy stored in the inductor is a maximum:
- A. just after the switch is closed
 - B. at the time $t = L/R$ after the switch is closed
 - C. at the time $t = L/R$ after the switch is closed
 - D. at the time $t = 2L/R$ after the switch is closed
 - E. a long time after the switch is closed
- ans: E
77. An inductance L and a resistance R are connected in series to an ideal battery. A switch in the circuit is closed at time 0, at which time the current is zero. The rate of increase of the energy stored in the inductor is a maximum:
- A. just after the switch is closed
 - B. at the time $t = L/R$ after the switch is closed
 - C. at the time $t = L/R$ after the switch is closed
 - D. at the time $t = (L/R) \ln 2$ after the switch is closed
 - E. a long time after the switch is closed
- ans: D

78. In each of the following operations, energy is expended. The LEAST percentage of returnable electrical energy will be yielded by:
- A. charging a capacitor
 - B. charging a storage battery
 - C. sending current through a resistor
 - D. establishing a current through an inductor
 - E. moving a conducting rod through a magnetic field
- ans: C
79. A current of 10 A in a certain inductor results in a stored energy of 40 J. When the current is changed to 5 A in the opposite direction, the stored energy changes by:
- A. 20 J
 - B. 30 J
 - C. 40 J
 - D. 50 J
 - E. 60 J
- ans: B
80. A 6.0-mH inductor is in a series circuit with a resistor and an ideal battery. At the instant the current in the circuit is 5.0 A the energy stored in the inductor is:
- A. 0
 - B. 7.5×10^{-2} J
 - C. 15×10^{-2} J
 - D. 30×10^{-2} J
 - E. unknown since the rate of change of the current is not given
- ans: B
81. A 6.0-mH inductor is in a circuit. At the instant the current is 5.0 A and its rate of change is 200 A/s, the rate with which the energy stored in the inductor is increasing is:
- A. 7.5×10^{-2} W
 - B. 120 W
 - C. 240 W
 - D. 3.0 W
 - E. 6.0 W
- ans: E
82. A 6.0-mH inductor and a 3.0- Ω resistor are wired in series to a 12-V ideal battery. A switch in the circuit is closed at time 0, at which time the current is zero. 2.0 ms later the energy stored in the inductor is:
- A. 0
 - B. 2.5×10^{-2} J
 - C. 1.9×10^{-2} J
 - D. 3.8×10^{-2} J
 - E. 9.6×10^{-3} J
- ans: C

83. The quantity B^2/μ_0 has units of:

- A. J
- B. J/H
- C. J/m
- D. J/m^3
- E. H/m^3

ans: D

84. A 0.20-cm radius cylinder, 3.0 cm long, is wrapped with wire to form an inductor. At the instant the magnetic field in the interior is 5.0 mT the energy stored in the field is about:

- A. 0
- B. $3.8 \times 10^{-6} \text{ J}$
- C. $7.5 \times 10^{-6} \text{ J}$
- D. $7.5 \times 10^{-4} \text{ J}$
- E. 9.9 J

ans: B

85. In the diagram, assume that all the magnetic field lines generated by coil 1 pass through coil 2. Coil 1 has 100 turns and coil 2 has 400 turns. Then:

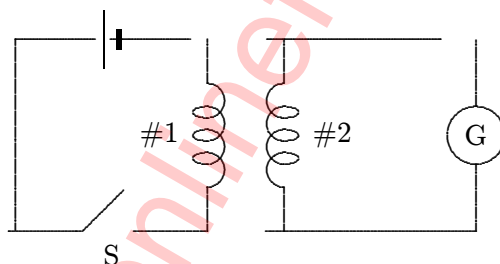

- A. the power supplied to coil 1 is equal to the power delivered by coil 2
- B. the emf around coil 1 will be one-fourth the emf around coil 2
- C. the current in coil 1 will be one-fourth the current in coil 2
- D. the emfs will be the same in the two coils
- E. none of the above

ans: E

**Chapter 31: ELECTROMAGNETIC OSCILLATIONS
AND ALTERNATING CURRENT**

1. A charged capacitor and an inductor are connected in series. At time $t = 0$ the current is zero, but the capacitor is charged. If T is the period of the resulting oscillations, the next time after $t = 0$ that the current is a maximum is:
 - A. T
 - B. $T/4$
 - C. $T/2$
 - D. T
 - E. $2T$ans: B

2. A charged capacitor and an inductor are connected in series. At time $t = 0$ the current is zero, but the capacitor is charged. If T is the period of the resulting oscillations, the next time after $t = 0$ that the charge on the capacitor is a maximum is:
 - A. T
 - B. $T/4$
 - C. $T/2$
 - D. T
 - E. $2T$ans: C

3. A charged capacitor and an inductor are connected in series. At time $t = 0$ the current is zero, but the capacitor is charged. If T is the period of the resulting oscillations, the next time after $t = 0$ that the voltage across the inductor is a maximum is:
 - A. T
 - B. $T/4$
 - C. $T/2$
 - D. T
 - E. $2T$ans: C

4. A charged capacitor and an inductor are connected in series. At time $t = 0$ the current is zero, but the capacitor is charged. If T is the period of the resulting oscillations, the next time after $t = 0$ that the energy stored in the magnetic field of the inductor is a maximum is:
 - A. T
 - B. $T/4$
 - C. $T/2$
 - D. T
 - E. $2T$ans: B

5. A charged capacitor and an inductor are connected in series. At time $t = 0$ the current is zero, but the capacitor is charged. If T is the period of the resulting oscillations, the next time after $t = 0$ that the energy stored in the electric field of the capacitor is a maximum is:
- A. T
 - B. $T/4$
 - C. $T/2$
 - D. T
 - E. $2T$

ans: C

6. A capacitor in an LC oscillator has a maximum potential difference of 15 V and a maximum energy of $360 \mu\text{J}$. At a certain instant the energy in the capacitor is $40 \mu\text{J}$. At that instant what is the potential difference across the capacitor?
- A. zero
 - B. 5 V
 - C. 10 V
 - D. 15 V
 - E. 20 V

ans: B

7. Which of the following has the greatest effect in decreasing the oscillation frequency of an LC circuit? Using instead:
- A. $L/2$ and $C/2$
 - B. $L/2$ and $2C$
 - C. $2L$ and $C/2$
 - D. $2L$ and $2C$
 - E. none of these

ans: D

8. We desire to make an LC circuit that oscillates at 100 Hz using an inductance of 2.5 H. We also need a capacitance of:
- A. 1 F
 - B. 1 mF
 - C. $1 \mu\text{F}$
 - D. $100 \mu\text{F}$
 - E. 1 pF

ans: C

9. An LC circuit consists of a $1\text{-}\mu\text{F}$ capacitor and a 4 mH inductor. Its oscillation frequency is approximately:
- A. 0.025 Hz
 - B. 25 Hz
 - C. 60 Hz
 - D. 2500 Hz
 - E. 15,800 Hz

ans: D

10. An LC circuit has an oscillation frequency of 10^5 Hz. If $C = 0.1 \mu\text{F}$, then L must be about:
- 10 mH
 - 1 mH
 - $25 \mu\text{H}$
 - $2.5 \mu\text{H}$
 - 1 pH

ans: C

11. In the circuit shown, switch S is first pushed up to charge the capacitor. When S is then pushed down, the current in the circuit will oscillate at a frequency of:

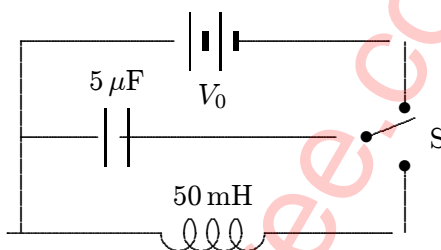

- 318 Hz
- 0.01 Hz
- 12.500 Hz
- 2000 Hz
- depends on V_0

ans: A

12. Radio receivers are usually tuned by adjusting the capacitor of an LC circuit. If $C = C_1$ for a frequency of 600 kHz, then for a frequency of 1200 kHz one must adjust C to:

- $C_1/2$
- $C_1/4$
- $2C_1$
- $4C_1$
- $\sqrt{2}C_1$

ans: B

13. An LC series circuit with an inductance L and a capacitance C has an oscillation frequency f . Two inductors, each with inductance L , and two capacitors, each with capacitance C , are all wired in series and the circuit is completed. The oscillation frequency is:

- $f/4$
- $f/2$
- f
- $2f$
- $4f$

ans: C

14. The electrical analog of a spring constant k is:
- A. L
 - B. $1/L$
 - C. C
 - D. $1/C$
 - E. R

ans: D

15. Consider the mechanical system consisting of two springs and a block, as shown. Which one of the five electrical circuits (A, B, C, D, E) is the analog of the mechanical system?

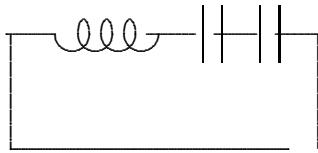
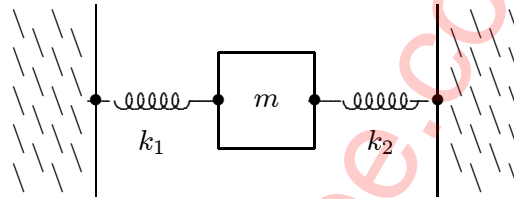

A

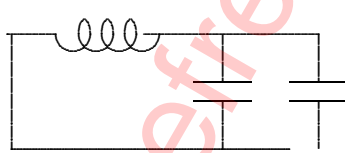

B

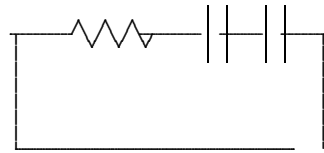

C

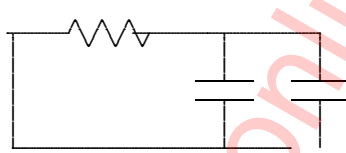

D

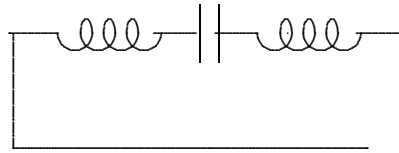

E

ans: A

16. A 150-g block on the end of a spring with a spring constant of 35 N/m is pulled aside 25 cm and released from rest. In the electrical analog the initial charge on the capacitor is:
- A. 0.15 C
 - B. 6.67 C
 - C. 0.025 C
 - D. 40 C
 - E. 35 C

ans: C

17. A 150-g block on the end of a spring with a spring constant of 35 N/m is pulled aside 25 cm and released from rest. In the electrical analog the maximum charge on the capacitor is 0.25 C. The maximum current in the LC circuit is:
- A. 0.38 A
 - B. 0.025 A
 - C. 40 A
 - D. 2.3 A
 - E. 5.3 A
- ans: A
18. A capacitor in an LC oscillator has a maximum potential difference of 15 V and a maximum energy of $360 \mu\text{J}$. At a certain instant the energy in the capacitor is $40 \mu\text{J}$. At that instant what is the potential difference across the capacitor?
- A. zero
 - B. 5 V
 - C. 10 V
 - D. 15 V
 - E. 20 V
- ans: B
19. A capacitor in an LC oscillator has a maximum potential difference of 15 V and a maximum energy of $360 \mu\text{J}$. At a certain instant the energy in the capacitor is $40 \mu\text{J}$. At that instant what is the emf induced in the inductor?
- A. zero
 - B. 5 V
 - C. 10 V
 - D. 15 V
 - E. 20 V
- ans: C
20. In an oscillating LC circuit, the total stored energy is U . The maximum energy stored in the capacitor during one cycle is:
- A. $U/2$
 - B. $U/\sqrt{2}$
 - C. U
 - D. $U/(2\pi)$
 - E. U/π
- ans: C
21. In an oscillating LC circuit, the total stored energy is U and the maximum charge on the capacitor is Q . When the charge on the capacitor is $Q/2$, the energy stored in the inductor is:
- A. $U/2$
 - B. $U/4$
 - C. $(4/3)U$
 - D. $3U/2$
 - E. $3U/4$
- ans: E

22. The total energy in an LC circuit is 5.0×10^{-6} J. If $C = 15 \mu\text{F}$ the charge on the capacitor is:
- A. $0.82 \mu\text{C}$
 - B. $8.5 \mu\text{C}$
 - C. $12 \mu\text{C}$
 - D. $17 \mu\text{C}$
 - E. $24 \mu\text{C}$
- ans: C
23. The total energy in an LC circuit is 5.0×10^{-6} J. If $L = 25 \text{mH}$ the maximum current is:
- A. 10 mA
 - B. 14 mA
 - C. 20 mA
 - D. 28 mA
 - E. 40 mA
- ans: C
24. At time $t = 0$ the charge on the $50\text{-}\mu\text{F}$ capacitor in an LC circuit is $15 \mu\text{C}$ and there is no current. If the inductance is 20 mH the maximum current is:
- A. 15 nA
 - B. $15 \mu\text{A}$
 - C. 6.7 mA
 - D. 15 mA
 - E. 15 A
- ans: D
25. An LC circuit has an inductance of 20 mH and a capacitance of $5.0 \mu\text{F}$. At time $t = 0$ the charge on the capacitor is $3.0 \mu\text{C}$ and the current is 7.0 mA. The total energy is:
- A. 4.1×10^{-7} J
 - B. 4.9×10^{-7} J
 - C. 9.0×10^{-7} J
 - D. 1.4×10^{-6} J
 - E. 2.8×10^{-6} J
- ans: D
26. An LC circuit has a capacitance of $30 \mu\text{F}$ and an inductance of 15 mH. At time $t = 0$ the charge on the capacitor is $10 \mu\text{C}$ and the current is 20 mA. The maximum charge on the capacitor is:
- A. $8.9 \mu\text{C}$
 - B. $10 \mu\text{C}$
 - C. $12 \mu\text{C}$
 - D. $17 \mu\text{C}$
 - E. $24 \mu\text{C}$
- ans: D

27. An LC circuit has an inductance of 15 mH and a capacitance of $10\text{ }\mu\text{F}$. At one instant the charge on the capacitor is $25\text{ }\mu\text{C}$. At that instant the current is changing at the rate of:
- 0
 - $1.7 \times 10^{-8}\text{ A/s}$
 - $5.9 \times 10^{-3}\text{ A/s}$
 - $3.8 \times 10^{-2}\text{ A/s}$
 - 170 A/s
- ans: E

28. An LC circuit has a capacitance of $30\text{ }\mu\text{F}$ and an inductance of 15 mH . At time $t = 0$ the charge on the capacitor is $10\text{ }\mu\text{C}$ and the current is 20 mA . The maximum current is:
- 18 mA
 - 20 mA
 - 25 mA
 - 35 mA
 - 42 mA
- ans: C

29. The graphs show the total electromagnetic energy in two RLC circuits as functions of time. Which of the following statements might be true?

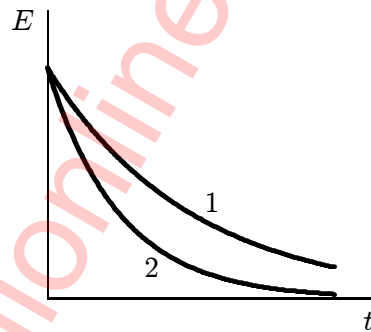

- Circuit 1 has a smaller resistance and a larger inductance
 - Circuit 1 has a larger resistance and a smaller inductance
 - Circuit 1 has the same resistance and a larger inductance
 - Circuit 1 has a larger resistance and a larger capacitance
 - Circuit 1 has the same resistance and a smaller capacitance
- ans: A
30. An RLC circuit has a resistance of $200\text{ }\Omega$ and an inductance of 15 mH . Its oscillation frequency is 7000 Hz . At time $t = 0$ the current is 25 mA and there is no charge on the capacitor. After five complete cycles the current is:
- zero
 - $1.8 \times 10^{-6}\text{ A}$
 - $2.1 \times 10^{-4}\text{ A}$
 - $2.3 \times 10^{-3}\text{ A}$
 - $2.5 \times 10^{-2}\text{ A}$
- ans: C

31. An RLC circuit has an inductance of 25 mH and a capacitance of $5.0\ \mu\text{F}$. The charge on the capacitor does NOT oscillate but rather decays exponentially to zero. The resistance in the circuit must be:
- A. greater than or equal to $20,000\ \Omega$
 - B. less than $20,000\ \Omega$ but greater than $10,000\ \Omega$
 - C. less than $10,000\ \Omega$ but greater than $5,000\ \Omega$
 - D. less than $5,000\ \Omega$ but greater than 0
 - E. 0

ans: A

32. A series circuit with an inductance of 15 mH , a capacitance of $35\ \mu\text{F}$, and a resistance of $5.0\ \Omega$ contains a sinusoidal source of emf with a frequency of 500 Hz . The frequency with which the charge on the capacitor oscillates is:
- A. 500 Hz
 - B. 1.4 kHz
 - C. greater than 1.4 kHz
 - D. less than 500 Hz
 - E. between 500 Hz and 1.4 kHz

ans: A

33. The rapid exponential decay in just a few cycles of the charge on the plates of capacitor in an RLC circuit might be due to:
- A. a large inductance
 - B. a large capacitance
 - C. a small capacitance
 - D. a large resistance
 - E. a small resistance

ans: D

34. An RLC circuit has a capacitance of $12\ \mu\text{F}$, an inductance of 25 mH , and a resistance of $60\ \Omega$. The current oscillates with an angular frequency of:
- A. $1.2 \times 10^3\text{ rad/s}$
 - B. $1.4 \times 10^3\text{ rad/s}$
 - C. $1.8 \times 10^3\text{ rad/s}$
 - D. $2.2 \times 10^3\text{ rad/s}$
 - E. $2.6 \times 10^3\text{ rad/s}$

ans: B

35. The angular frequency of a certain RLC series circuit is ω_0 . A source of sinusoidal emf, with angular frequency 2ω , is inserted into the circuit. After transients die out the angular frequency of the current oscillations is:
- A. $\omega_0/2$
 - B. ω_0
 - C. $2\omega_0$
 - D. $1.5\omega_0$
 - E. $3\omega_0$

ans: C

36. The angular frequency of a certain *RLC* series circuit is ω_0 . A source of sinusoidal emf, with angular frequency ω , is inserted into the circuit and ω is varied while the amplitude of the source is held constant. For which of the following values of ω is the amplitude of the current oscillations the greatest?
- A. $\omega_0/5$
 - B. $\omega_0/2$
 - C. ω_0
 - D. $2\omega_0$
 - E. None of them (they all produce the same current amplitude)

ans: C

37. An *RLC* circuit has a sinusoidal source of emf. The average rate at which the source supplies energy is 5 nW. This must also be:
- A. the average rate at which energy is stored in the capacitor
 - B. the average rate at which energy is stored in the inductor
 - C. the average rate at which energy is dissipated in the resistor
 - D. twice the average rate at which energy is stored in the capacitor
 - E. three times the average rate at which energy is stored in the inductor

ans: C

38. In a purely capacitive circuit the current:
- A. leads the voltage by one-fourth of a cycle
 - B. leads the voltage by one-half of a cycle
 - C. lags the voltage by one-fourth of a cycle
 - D. lags the voltage by one-half of a cycle
 - E. is in phase with the potential difference across the plates

ans: A

39. In a purely resistive circuit the current:
- A. leads the voltage by one-fourth of a cycle
 - B. leads the voltage by one-half of a cycle
 - C. lags the voltage by one-fourth of a cycle
 - D. lags the voltage by one-half of a cycle
 - E. is in phase with the voltage

ans: E

40. In a purely inductive circuit, the current lags the voltage by:
- A. zero
 - B. one-fourth of a cycle
 - C. one-half of a cycle
 - D. three-fourths of a cycle
 - E. one cycle

ans: B

41. A series RL circuit is connected to an emf source of angular frequency ω . The current:
- A. leads the applied emf by $\tan^{-1}(\omega L/R)$
 - B. lags the applied emf by $\tan^{-1}(\omega L/R)$
 - C. lags the applied emf by $\tan^{-1}(\omega R/L)$
 - D. leads the applied emf by $\tan^{-1}(\omega R/L)$
 - E. is zero
- ans: B
42. A series RC circuit is connected to an emf source having angular frequency ω . The current:
- A. leads the source emf by $\tan^{-1}(1/\omega CR)$
 - B. lags the source emf by $\tan^{-1}(1/\omega CR)$
 - C. leads the source emf by $\tan^{-1}(\omega CR)$
 - D. lags the source emf by $\tan^{-1}(\omega CR)$
 - E. leads the source emf by $\pi/4$
- ans: A
43. In an RLC series circuit, which is connected to a source of emf $\mathcal{E}_m \cos(\omega t)$, the current lags the voltage by 45° if:
- A. $R = 1/\omega C - \omega L$
 - B. $R = 1/\omega L - \omega C$
 - C. $R = \omega L - 1/\omega C$
 - D. $R = \omega C - 1/\omega L$
 - E. $\omega L = 1/\omega C$
- ans: C
44. A coil has a resistance of $60\ \Omega$ and an impedance of $100\ \Omega$. Its reactance, in ohms, is:
- A. 40
 - B. 60
 - C. 80
 - D. 117
 - E. 160
- ans: C
45. The reactance in ohms of a $35\text{-}\mu\text{F}$ capacitor connected to a 400-Hz generator is:
- A. 0
 - B. 0.014
 - C. 0.088
 - D. 11
 - E. 71
- ans: D

46. A $35\text{-}\mu\text{F}$ capacitor is connected to a source of sinusoidal emf with a frequency of 400 Hz and a maximum emf of 20 V. The maximum current is:
- A. 0
 - B. 0.28 A
 - C. 1.8 A
 - D. 230 A
 - E. 1400 A
- ans: C
47. A 45-mH inductor is connected to a source of sinusoidal emf with a frequency of 400 Hz and a maximum emf of 20 V. The maximum current is:
- A. 0
 - B. 0.18 A
 - C. 1.1 A
 - D. 360 A
 - E. 2300 A
- ans: B
48. The impedance of an RLC series circuit is definitely increased if:
- A. C decreases
 - B. L increases
 - C. L decreases
 - D. R increases
 - E. R decreases
- ans: D
49. An RLC series circuit has $R = 4\ \Omega$, $X_C = 3\ \Omega$, and $X_L = 6\ \Omega$. The impedance of this circuit is:
- A. $5\ \Omega$
 - B. $7\ \Omega$
 - C. $9.8\ \Omega$
 - D. $13\ \Omega$
 - E. $7.8\ \Omega$
- ans: A

50. The impedance of the circuit shown is:

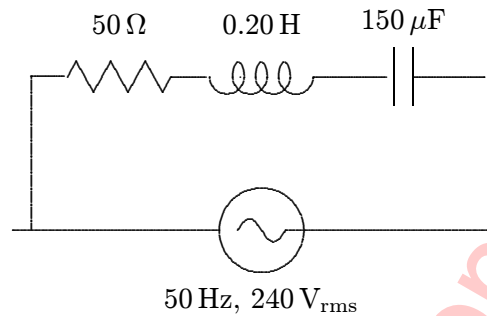

- A. $21\ \Omega$
- B. $50\ \Omega$
- C. $63\ \Omega$
- D. $65\ \Omega$
- E. $98\ \Omega$

ans: D

51. An electric motor, under load, has an effective resistance of $30\ \Omega$ and an inductive reactance of $40\ \Omega$. When powered by a source with a maximum voltage of $420\ \text{V}$, the maximum current is:

- A. $6.0\ \text{A}$
- B. $8.4\ \text{A}$
- C. $10.5\ \text{A}$
- D. $12.0\ \text{A}$
- E. $14.0\ \text{A}$

ans: B

52. An RL series circuit is connected to an ac generator with a maximum emf of $20\ \text{V}$. If the maximum potential difference across the resistor is $16\ \text{V}$, then the maximum potential difference across the inductor is:

- A. $2\ \text{V}$
- B. $4\ \text{V}$
- C. $12\ \text{V}$
- D. $25.6\ \text{V}$
- E. $36\ \text{V}$

ans: C

53. When the amplitude of the oscillator in a series RLC circuit is doubled:

- A. the impedance is doubled
- B. the voltage across the capacitor is halved
- C. the capacitive reactance is halved
- D. the power factor is doubled
- E. the current amplitude is doubled

ans: E

54. When the frequency of the oscillator in a series RLC circuit is doubled:
- the capacitive reactance is doubled
 - the capacitive reactance is halved
 - the impedance is doubled
 - the current amplitude is doubled
 - the current amplitude is halved

ans: B

55. In an RLC series circuit, the source voltage is leading the current at a given frequency f . If f is lowered slightly, then the circuit impedance will:
- increase
 - decrease
 - remain the same
 - need to know the amplitude of the source voltage
 - need to know whether the phase angle is larger or smaller than 45°

ans: B

56. In the diagram, the function $y(t) = y_m \sin(\omega t)$ is plotted as a solid curve. The other three curves have the form $y(t) = y_m \sin(\omega t + \phi)$, where ϕ is between $-\pi/2$ and $+\pi/2$. Rank the curves according to the value of ϕ , from the most negative to the most positive.

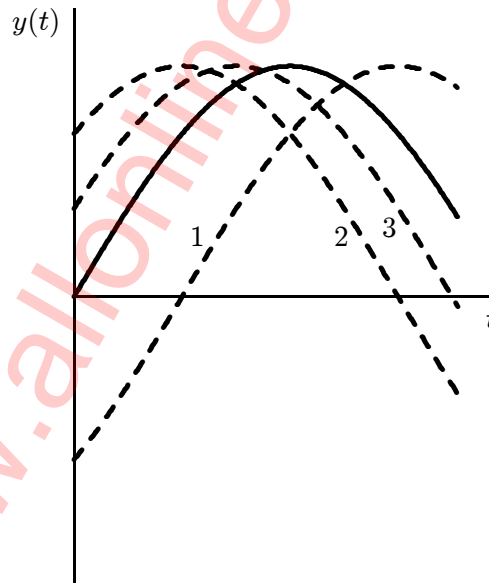

- 1, 2, 3
- 2, 3, 1
- 3, 2, 1
- 1, 3, 2
- 2, 1, 3

ans: D

57. An RLC series circuit has $L = 100 \text{ mH}$ and $C = 1 \mu\text{F}$. It is connected to a 1000-Hz source and the source emf is found to lead the current by 75° . The value of R is:
- 12.6Ω
 - 126Ω
 - 175Ω
 - 1750Ω
 - 1810Ω
- ans: B
58. An RLC series circuit is driven by a sinusoidal emf with angular frequency ω_d . If ω_d is increased without changing the amplitude of the emf the current amplitude increases. If L is the inductance, C is the capacitance, and R is the resistance, this means that:
- $\omega_d L > 1/\omega_d C$
 - $\omega_d L < 1/\omega_d C$
 - $\omega_d L = 1/\omega_d C$
 - $\omega_d L > R$
 - $\omega_d L < R$
- ans: B
59. In a sinusoidally driven series RLC circuit, the inductive reactance is $X_L = 200 \Omega$, the capacitive reactance is $X_C = 100 \Omega$, and the resistance is $R = 50 \Omega$. The current and applied emf would be in phase if:
- the resistance is increased to 100Ω , with no other changes
 - the resistance is increased to 200Ω , with no other changes
 - the inductance is reduced to zero, with no other changes
 - the capacitance is doubled, with no other changes
 - the capacitance is halved, with no other changes
- ans: E
60. In a sinusoidally driven series RLC circuit the current lags the applied emf. The rate at which energy is dissipated in the resistor can be increased by:
- decreasing the capacitance and making no other changes
 - increasing the capacitance and making no other changes
 - increasing the inductance and making no other changes
 - increasing the driving frequency and making no other changes
 - decreasing the amplitude of the driving emf and making no other changes
- ans: A
61. An RLC series circuit, connected to a source E , is at resonance. Then:
- the voltage across R is zero
 - the voltage across R equals the applied voltage
 - the voltage across C is zero
 - the voltage across L equals the applied voltage
 - the applied voltage and current differ in phase by 90°
- ans: B

62. An RLC series circuit is connected to an oscillator with a maximum emf of 100 V. If the voltage amplitudes V_R , V_L , and V_C are all equal to each other, then V_R must be:
- 33 V
 - 50 V
 - 67 V
 - 87 V
 - 100 V

ans: E

63. A resistor, an inductor, and a capacitor are connected in parallel to a sinusoidal source of emf. Which of the following is true?
- The currents in all branches are in phase.
 - The potential differences across all branches are in phase.
 - The current in the capacitor branch leads the current in the inductor branch by one-fourth of a cycle
 - The potential difference across the capacitor branch leads the potential difference across the inductor branch by one-fourth of a cycle.
 - The current in the capacitor branch lags the current in the inductor branch by one-fourth of a cycle.

ans: B

64. The rms value of an ac current is:
- its peak value
 - its average value
 - that steady current that produces the same rate of heating in a resistor as the actual current
 - that steady current that will charge a battery at the same rate as the actual current
 - zero

ans: C

65. The rms value of a sinusoidal voltage is $V_0/\sqrt{2}$, where V_0 is the amplitude. What is the rms value of its fully rectified wave? Recall that $V_{\text{rect}}(t) = |V(t)|$.

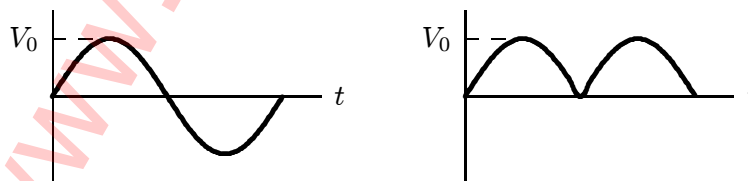

- $V_0^2/\sqrt{2}$
- $V_0^2/2$
- $\sqrt{2}V_0$
- $V_0/\sqrt{2}$
- $V_0/(2\sqrt{2})$

ans: D

66. A sinusoidal voltage $V(t)$ has an rms value of 100 V. Its maximum value is:
- A. 100 V
 - B. 707 V
 - C. 70.7 V
 - D. 141 V
 - E. 200 V
- ans: D
67. An ac generator produces 10 V (rms) at 400 rad/s. It is connected to a series RL circuit ($R = 17.3 \Omega$, $L = 0.025 \text{ H}$). The rms current is:
- A. 0.50 A and leads the emf by 30°
 - B. 0.71 A and lags the emf by 30°
 - C. 1.40 A and lags the emf by 60°
 - D. 0.50 A and lags the emf by 30°
 - E. 0.58 A and leads the emf by 90°
- ans: D
68. An ac generator producing 10 V (rms) at 200 rad/s is connected in series with a $50\text{-}\Omega$ resistor, a 400-mH inductor, and a $200\text{-}\mu\text{F}$ capacitor. The rms current in amperes is:
- A. 0.125
 - B. 0.135
 - C. 0.18
 - D. 0.20
 - E. 0.40
- ans: B
69. An ac generator producing 10 V (rms) at 200 rad/s is connected in series with a $50\text{-}\Omega$ resistor, a 400-mH inductor, and a $200\text{-}\mu\text{F}$ capacitor. The rms voltage (in volts) across the resistor is:
- A. 2.5
 - B. 3.4
 - C. 6.7
 - D. 10.0
 - E. 10.8
- ans: C
70. An ac generator producing 10 V (rms) at 200 rad/s is connected in series with a $50\text{-}\Omega$ resistor, a 400-mH inductor, and a $200\text{-}\mu\text{F}$ capacitor. The rms voltage (in volts) across the capacitor is:
- A. 2.5
 - B. 3.4
 - C. 6.7
 - D. 10.0
 - E. 10.8
- ans: B

71. An ac generator producing 10 V (rms) at 200 rad/s is connected in series with a 50- Ω resistor, a 400-mH inductor, and a 200- μ F capacitor. The rms voltage (in volts) across the inductor is:
- A. 2.5
 - B. 3.4
 - C. 6.7
 - D. 10.0
 - E. 10.8
- ans: E

72. The ideal meters shown read rms current and voltage. The average power delivered to the load is:

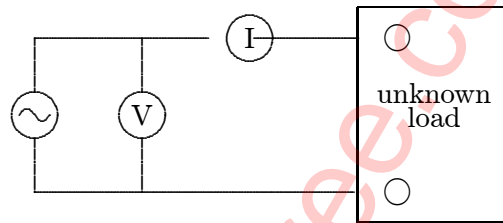

- A. definitely equal to VI
 - B. definitely more than VI
 - C. possibly equal to VI even if the load contains an inductor and a capacitor
 - D. definitely less than VI
 - E. zero, as is the average of any sine wave
- ans: C
73. The average power supplied to the circuit shown passes through a maximum when which one of the following is increased continuously from a very low to a very high value?

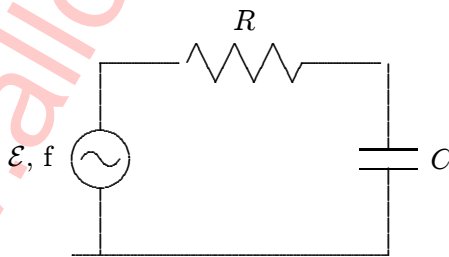

- A. Source emf \mathcal{E}
 - B. R
 - C. C
 - D. Source frequency f
 - E. None of these
- ans: B

74. In a series RLC circuit the rms value of the generator emf is E and the rms value of the current is i . The current lags the emf by ϕ . The average power supplied by the generator is given by:
- A. $(iE/2) \cos \phi$
 - B. iE
 - C. i^2/Z
 - D. i^2Z
 - E. i^2R
- ans: E
75. The units of the power factor are:
- A. ohm
 - B. watt
 - C. radian
 - D. $\text{ohm}^{1/2}$
 - E. none of these
- ans: E
76. A series circuit consists of a $15\text{-}\Omega$ resistor, a 25-mH inductor, and a $35\text{-}\mu\text{F}$ capacitor. If the frequency is 100 Hz the power factor is:
- A. 0
 - B. 0.20
 - C. 0.45
 - D. 0.89
 - E. 1.0
- ans: C
77. The main reason that alternating current replaced direct current for general use is:
- A. ac generators do not need slip rings
 - B. ac voltages may be conveniently transformed
 - C. electric clocks do not work on dc
 - D. a given ac current does not heat a power line as much as the same dc current
 - E. ac minimizes magnetic effects
- ans: B
78. A step-down transformer is used to:
- A. increase the power
 - B. decrease the power
 - C. increase the voltage
 - D. decrease the voltage
 - E. change ac to dc
- ans: D

79. Iron, rather than copper, is used in the core of transformers because iron:
- A. can withstand a higher temperature
 - B. has a greater resistivity
 - C. has a very high permeability
 - D. makes a good permanent magnet
 - E. insulates the primary from the secondary
- ans: C
80. The core of a transformer is made in a laminated form to:
- A. facilitate easy assembly
 - B. reduce i^2R losses in the coils
 - C. increase the magnetic flux
 - D. save weight
 - E. prevent eddy currents
- ans: E
81. A generator supplies 100 V to the primary coil of a transformer. The primary has 50 turns and the secondary has 500 turns. The secondary voltage is:
- A. 1000 V
 - B. 500 V
 - C. 250 V
 - D. 100 V
 - E. 10 V
- ans: A
82. The resistance of the primary coil of a well-designed, 1 : 10 step-down transformer is $1\ \Omega$. With the secondary circuit open, the primary is connected to a 12 V ac generator. The primary current is:
- A. essentially zero
 - B. about 12 A
 - C. about 120 A
 - D. depends on the actual number of turns in the primary coil
 - E. depends on the core material
- ans: A
83. The primary of an ideal transformer has 100 turns and the secondary has 600 turns. Then:
- A. the power in the primary circuit is less than that in the secondary circuit
 - B. the currents in the two circuits are the same
 - C. the voltages in the two circuits are the same
 - D. the primary current is six times the secondary current
 - E. the frequency in the secondary circuit is six times that in the primary circuit
- ans: D

84. The primary of a 3 : 1 step-up transformer is connected to a source and the secondary is connected to a resistor R . The power dissipated by R in this situation is P . If R is connected directly to the source it will dissipate a power of:
- A. $P/9$
 - B. $P/3$
 - C. P
 - D. $3P$
 - E. $9P$

ans: A

85. In an ideal 1 : 8 step-down transformer, the primary power is 10 kW and the secondary current is 25 A. The primary voltage is:
- A. 25,600 V
 - B. 3200 V
 - C. 400 V
 - D. 50 V
 - E. 6.25 V

ans: B

86. A source with an impedance of $100\ \Omega$ is connected to the primary coil of a transformer and a resistance R is connected to the secondary coil. If the transformer has 500 turns in its primary coil and 100 turns in its secondary coil the greatest power will be dissipated in the resistor if $R =$:
- A. 0
 - B. $0.25\ \Omega$
 - C. $4.0\ \Omega$
 - D. $50\ \Omega$
 - E. $100\ \Omega$

ans: C

Chapter 32: MAXWELL'S EQUATIONS; MAGNETISM AND MATTER

- Gauss' law for magnetism:
 - can be used to find \vec{B} due to given currents provided there is enough symmetry
 - is false because there are no magnetic poles
 - can be used with open surfaces because there are no magnetic poles
 - contradicts Faraday's law because one says $\Phi_B = 0$ and the other says $\mathcal{E} = -d\Phi_B/dt$
 - none of the aboveans: E
- Gauss' law for magnetism tells us:
 - the net charge in any given volume
 - that the line integral of a magnetic field around any closed loop must vanish
 - the magnetic field of a current element
 - that magnetic monopoles do not exist
 - charges must be moving to produce magnetic fieldsans: D
- The statement that magnetic field lines form closed loops is a direct consequence of:
 - Faraday's law
 - Ampere's law
 - Gauss' law for electricity
 - Gauss' law for magnetism
 - the Lorentz forceans: D
- A magnetic field parallel to the x axis with a magnitude that decreases with increasing x but does not change with y and z is impossible according to:
 - Faraday's law
 - Ampere's law
 - Gauss' law for electricity
 - Gauss' law for magnetism
 - Newton's second lawans: D
- According to Gauss' law for magnetism, magnetic field lines:
 - form closed loops
 - start at south poles and end at north poles
 - start at north poles and end at south poles
 - start at both north and south poles and end at infinity
 - do not existans: A

6. The magnetic field lines due to an ordinary bar magnet:
- form closed curves
 - cross one another near the poles
 - are more numerous near the N pole than near the S pole
 - do not exist inside the magnet
 - none of the above

ans: A

7. Four closed surfaces are shown. The areas A_{top} and A_{bot} of the top and bottom faces and the magnitudes B_{top} and B_{bot} of the uniform magnetic fields through the top and bottom faces are given. The fields are perpendicular to the faces and are either inward or outward. Rank the surfaces according to the magnitude of the magnetic flux through the curved sides, least to greatest.

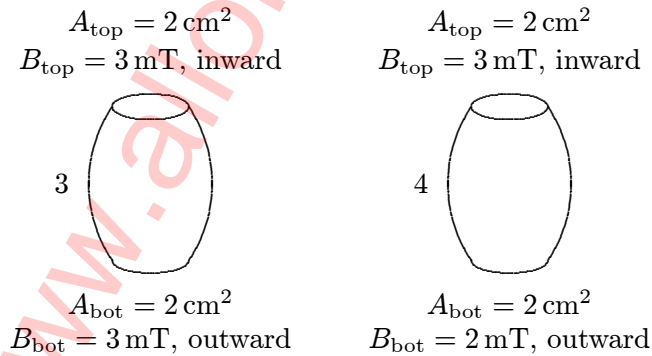
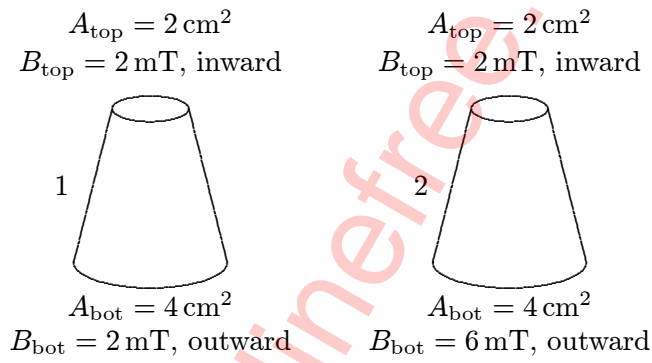

- 1, 2, 3, 4
- 3, 4, 1, 2
- 1, 2, 4, 3
- 4, 3, 2, 1
- 2, 1, 4, 3

ans: B

8. Consider the four Maxwell equations:

1. $\oint \vec{E} \cdot d\vec{A} = q/\epsilon_0$
2. $\oint \vec{B} \cdot d\vec{A} = 0$
3. $\oint \vec{E} \cdot d\vec{s} = -d\Phi_B/dt$
4. $\oint \vec{B} \cdot d\vec{s} = \mu_0 i + \mu_0 \epsilon_0 d\Phi_E/dt$

Which of these must be modified if magnetic poles are discovered?

- A. Only 1
- B. Only 2
- C. Only 2 and 3
- D. Only 3 and 4
- E. Only 2, 3, and 4

ans: C

9. One of the Maxwell equations begins with $\oint \vec{B} \cdot d\vec{s} = \dots$. The symbol “ $d\vec{s}$ ” means:

- A. an infinitesimal displacement of a charge
- B. an infinitesimal displacement of a magnetic pole
- C. an infinitesimal inductance
- D. an infinitesimal surface area
- E. none of the above

ans: E

10. One of the Maxwell equations begins with $\oint \vec{E} \cdot d\vec{s} = \dots$. The “ \circ ” symbol in the integral sign means:

- A. the same as the subscript in μ_0
- B. integrate clockwise around the path
- C. integrate counterclockwise around the path
- D. integrate around a closed path
- E. integrate over a closed surface

ans: D

11. One of the Maxwell equations begins with $\oint \vec{B} \cdot d\vec{A} = \dots$. The “ \circ ” symbol in the integral sign means:

- A. the same as the subscript in μ_0
- B. integrate clockwise around the path
- C. integrate counterclockwise around the path
- D. integrate around a closed path
- E. integrate over a closed surface

ans: E

12. One of the crucial facts upon which the Maxwell equations are based is:

- A. the numerical value of the electron charge
- B. charge is quantized
- C. the numerical value of the charge/mass ratio of the electron
- D. there are three types of magnetic materials
- E. none of the above

ans: E

13. Two of Maxwell's equations contain a path integral on the left side and an area integral on the right. For them:
- the path must pierce the area
 - the path must be well-separated from the area
 - the path must be along a field line and the area must be perpendicular to the field line
 - the path must be the boundary of the area
 - the path must lie in the area, away from its boundary
- ans: D
14. Two of Maxwell's equations contain an integral over a closed surface. For them the infinitesimal vector area $d\vec{A}$ is always:
- tangent to the surface
 - perpendicular to the surface and pointing outward
 - perpendicular to the surface and pointing inward
 - tangent to a field line
 - perpendicular to a field line
- ans: B
15. Two of Maxwell's equations contain a path integral on the left side and an area integral on the right. The directions of the infinitesimal path element $d\vec{s}$ and infinitesimal area element $d\vec{A}$ are:
- always in the same direction
 - always in opposite directions
 - always perpendicular to each other
 - never perpendicular to each other
 - none of the above
- ans: E
16. Two of Maxwell's equations contain a path integral on the left side and an area integral on the right. Suppose the area is the surface of a piece of paper at which you are looking and $d\vec{A}$ is chosen to point toward you. Then, the path integral is:
- clockwise around the circumference of the paper
 - counterclockwise around the circumference of the paper
 - from left to right
 - from right to left
 - from top to bottom
- ans: B
17. Which of the following equations can be used, along with a symmetry argument, to calculate the electric field of a point charge?
- $\oint \vec{E} \cdot d\vec{A} = q/\epsilon_0$
 - $\oint \vec{B} \cdot d\vec{A} = 0$
 - $\oint \vec{E} \cdot d\vec{s} = -d\Phi_B/dt$
 - $\oint \vec{B} \cdot d\vec{s} = \mu_0 i + \mu_0 \epsilon_0 d\Phi_E/dt$
 - None of these
- ans: A

18. Which of the following equations can be used, along with a symmetry argument, to calculate the magnetic field of a long straight wire carrying current?
- $\oint \vec{E} \cdot d\vec{A} = q/\epsilon_0$
 - $\oint \vec{B} \cdot d\vec{A} = 0$
 - $\oint \vec{E} \cdot d\vec{s} = -d\Phi_B/dt$
 - $\oint \vec{B} \cdot d\vec{s} = \mu_0 i + \mu_0 \epsilon_0 d\Phi_E/dt$
 - None of these
- ans: D
19. Which of the following equations can be used to show that magnetic field lines form closed loops?
- $\oint \vec{E} \cdot d\vec{A} = q/\epsilon_0$
 - $\oint \vec{B} \cdot d\vec{A} = 0$
 - $\oint \vec{E} \cdot d\vec{s} = -d\Phi_B/dt$
 - $\oint \vec{B} \cdot d\vec{s} = \mu_0 i + \mu_0 \epsilon_0 d\Phi_E/dt$
 - None of these
- ans: B
20. Which of the following equations, along with a symmetry argument, can be used to calculate the magnetic field produced by a uniform time-varying electric field?
- $\oint \vec{E} \cdot d\vec{A} = q/\epsilon_0$
 - $\oint \vec{B} \cdot d\vec{A} = 0$
 - $\oint \vec{E} \cdot d\vec{s} = -d\Phi_B/dt$
 - $\oint \vec{B} \cdot d\vec{s} = \mu_0 i + \mu_0 \epsilon_0 d\Phi_E/dt$
 - None of these
- ans: D
21. Which of the following equations, along with a symmetry argument, can be used to calculate the electric field produced by a uniform time-varying magnetic field?
- $\oint \vec{E} \cdot d\vec{A} = q/\epsilon_0$
 - $\oint \vec{B} \cdot d\vec{A} = 0$
 - $\oint \vec{E} \cdot d\vec{s} = -d\Phi_B/dt$
 - $\oint \vec{B} \cdot d\vec{s} = \mu_0 i + \mu_0 \epsilon_0 d\Phi_E/dt$
 - None of these
- ans: C
22. Which of the following equations, along with a symmetry argument, can be used to calculate the magnetic field between the plates of a charging parallel plate capacitor with circular plates?
- $\oint \vec{E} \cdot d\vec{A} = q/\epsilon_0$
 - $\oint \vec{B} \cdot d\vec{A} = 0$
 - $\oint \vec{E} \cdot d\vec{s} = -d\Phi_B/dt$
 - $\oint \vec{B} \cdot d\vec{s} = \mu_0 i + \mu_0 \epsilon_0 d\Phi_E/dt$
 - None of these
- ans: D

23. Maxwell's equations, along with an appropriate symmetry argument, can be used to calculate:
- A. the electric force on a given charge
 - B. the magnetic force on a given moving charge
 - C. the flux of a given electric field
 - D. the flux of a given magnetic field
 - E. none of these
- ans: E
24. The polarity of an unmarked magnet can be determined using:
- A. a charged glass rod
 - B. a compass
 - C. an electroscope
 - D. another unmarked magnet
 - E. iron filings
- ans: B
25. A bar magnet is placed vertically with its S pole up and its N pole down. Its \vec{B} field at its center is:
- A. zero
 - B. down
 - C. up due to the weight of the magnet
 - D. horizontal
 - E. slightly below the horizontal
- ans: B
26. A bar magnet is broken in half. Each half is broken in half again, etc. The observation is that each piece has both a north and south pole. This is usually explained by:
- A. Ampere's theory that all magnetic phenomena result from electric currents
 - B. our inability to divide the magnet into small enough pieces
 - C. Coulomb's law
 - D. Lenz' law
 - E. conservation of charge.
- ans: A
27. A small bar magnet is suspended horizontally by a string. When placed in a uniform horizontal magnetic field, it will:
- A. translate in the direction of \vec{B}
 - B. translate in the opposite direction of \vec{B}
 - C. rotate so as to be at right angles to \vec{B}
 - D. rotate so as to be vertical
 - E. none of the above
- ans: E

28. Magnetic dipole X is fixed and dipole Y is free to move. Dipole Y will initially:



- A. move toward X but not rotate
- B. move away from X but not rotate
- C. move toward X and rotate
- D. move away from X and rotate
- E. rotate but not translate

ans: A

29. Magnetic dipole X is fixed and dipole Y is free to move. Dipole Y will initially:

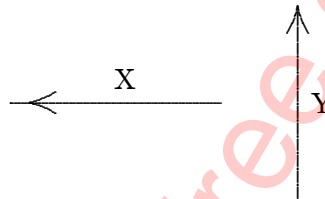

- A. move toward X but not rotate
- B. move away from X but not rotate
- C. move toward X and rotate
- D. move away from X and rotate
- E. rotate but not move toward or away from X

ans: E

30. The diagram shows the angular momentum vectors of two electrons and two protons in the same external magnetic field. The field points upward in the diagram. Rank the situations according to the potential energy, least to greatest.

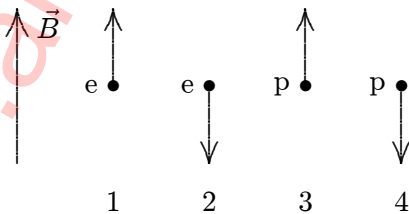

- A. 1 and 3 tie, then 2 and 4 tie
- B. 2 and 3 tie, then 1 and 4 tie
- C. 1 and 2 tie, then 3 and 4 tie
- D. 3 and 4 tie, then 1 and 2 tie
- E. all tie

ans: B

31. The energy of a magnetic dipole in an external magnetic field is least when:
- A. the dipole moment is parallel to the field
 - B. the dipole moment is antiparallel to the field
 - C. the dipole moment is perpendicular to the field
 - D. none of the above (the same energy is associated with all orientations)
 - E. none of the above (no energy is associated with the dipole-field interaction)
- ans: A
32. The magnetic properties of materials stem chiefly from:
- A. particles with north poles
 - B. particles with south poles
 - C. motions of protons within nuclei
 - D. proton spin angular momentum
 - E. electron magnetic dipole moments
- ans: E
33. Magnetization is:
- A. the current density in an object
 - B. the charge density of moving charges in an object
 - C. the magnetic dipole moment of an object
 - D. the magnetic dipole moment per unit volume of an object
 - E. the magnetic field per unit volume produced by an object
- ans: D
34. The units of magnetization are:
- A. ampere
 - B. ampere·meter
 - C. ampere·meter²
 - D. ampere/meter
 - E. ampere/meter²
- ans: D
35. If \vec{L} is the orbital angular momentum of an electron, the magnetic dipole moment associated with its orbital motion:
- A. is in the direction of \vec{L} and has magnitude proportional to L
 - B. is opposite to the direction of \vec{L} and has magnitude proportional to L
 - C. is in the direction of \vec{L} and has magnitude proportional to L^2
 - D. is opposite to the direction of \vec{L} and has magnitude proportional to L^2
 - E. does not depend on \vec{L}
- ans: B

36. If an electron has an orbital angular momentum with magnitude L the magnitude of the orbital contribution to its magnetic dipole moment is given by:
- A. eL/m
 - B. $eL/2m$
 - C. $2eL/m$
 - D. mL/e
 - E. $mL/2$
- ans: B
37. An electron traveling with speed v around a circle of radius r is equivalent to a current of:
- A. $evr/2$
 - B. ev/r
 - C. $ev/2\pi r$
 - D. $2\pi er/v$
 - E. $2\pi ev/r$
- ans: C
38. The intrinsic magnetic dipole moments of protons and neutrons are much less than that of an electron because:
- A. their masses are greater
 - B. their angular momenta are much less
 - C. their angular momenta are much greater
 - D. their charges are much less
 - E. their radii are much less
- ans: A
39. The spin magnetic dipole moment of an electron:
- A. is in the same direction as the spin angular momentum
 - B. is zero
 - C. has a magnitude that depends on the orbital angular momentum
 - D. has a magnitude that depends on the applied magnetic field
 - E. none of the above
- ans: E
40. If an electron has zero orbital angular momentum, the magnitude of its magnetic dipole moment equals:
- A. zero
 - B. half the Bohr magneton
 - C. a Bohr magneton
 - D. twice a Bohr magneton
 - E. none of these
- ans: C

41. The magnetic dipole moment of an atomic electron is typically:
- A. much less than a Bohr magneton
 - B. a few Bohr magnetons
 - C. much greater than a Bohr magneton
 - D. much greater or much less than a Bohr magneton, depending on the atom
 - E. not related to the value of the Bohr magneton

ans: B

42. The magnitude of the Bohr magneton in J/T is about:
- A. 10^{-15}
 - B. 10^{-19}
 - C. 10^{-23}
 - D. 10^{-27}
 - E. 10^{-31}

ans: C

43. The molecular theory of magnetism can explain each of the following EXCEPT:
- A. an N pole attracts a S pole
 - B. stroking an iron bar with a magnet will magnetize the bar
 - C. when a bar magnet is broken in two, each piece is a bar magnet
 - D. heating tends to destroy magnetization
 - E. hammering tends to destroy magnetization

ans: A

44. Lenz' law can explain:
- A. paramagnetism only
 - B. diamagnetism only
 - C. ferromagnetism only
 - D. only two of the three types of magnetism
 - E. all three of the types of magnetism

ans: B

45. The diagram shows two small diamagnetic spheres, one near each end of a bar magnet. Which of the following statements is true?

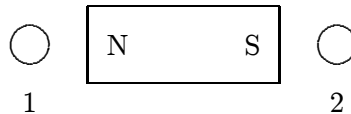

- A. The force on 1 is toward the magnet and the force on 2 is away from the magnet
- B. The force on 1 is away from the magnet and the force on 2 is away from the magnet
- C. The forces on 1 and 2 are both toward the magnet
- D. The forces on 1 and 2 are both away from the magnet
- E. The magnet does not exert a force on either sphere

ans: D

46. Paramagnetism is closely associated with:
- the tendency of electron dipole moments to align with an applied magnetic field
 - the tendency of electron dipole moments to align opposite to an applied magnetic field
 - the exchange force between electrons
 - the force exerted by electron dipole moments on each other
 - the torque exerted by electron dipole moments on each other

ans: A

47. The diagram shows two small paramagnetic spheres, one near each end of a bar magnet. Which of the following statements is true?

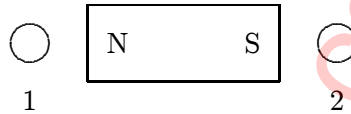

- The force on 1 is toward the magnet and the force on 2 is away from the magnet
- The force on 1 is away from the magnet and the force on 2 is away from the magnet
- The forces on 1 and 2 are both toward the magnet
- The forces on 1 and 2 are both away from the magnet
- The magnet does not exert a force on either sphere

ans: C

48. A paramagnetic substance is placed in a weak magnetic field and its absolute temperature T is increased. As a result, its magnetization:
- increases in proportion to T
 - increases in proportion to T^2
 - remains the same
 - decreases in proportion to $1/T$
 - decreases in proportion to $1/T^2$

ans: D

49. A magnetic field \vec{B}_0 is applied to a paramagnetic substance. In the interior the magnetic field produced by the magnetic dipoles of the substance is:
- greater than \vec{B}_0 and in the opposite direction
 - less than \vec{B}_0 and in the opposite direction
 - greater than \vec{B}_0 and in the same direction
 - less than \vec{B}_0 and in the same direction
 - the same as \vec{B}_0

ans: D

50. A paramagnetic substance, in an external magnetic field, is thermally isolated. The field is then removed. As a result:
- the magnetic energy of the magnetic dipoles decreases
 - the temperature of the substance increases
 - the magnetization decreases, but only slightly
 - the magnetization reverses direction
 - none of the above

ans: E

51. A magnetic field \vec{B}_0 is applied to a diamagnetic substance. In the interior the magnetic field produced by the magnetic dipoles of the substance is:
- A. greater than \vec{B}_0 and in the opposite direction
 - B. less than \vec{B}_0 and in the opposite direction
 - C. greater than \vec{B}_0 and in the same direction
 - D. less than \vec{B}_0 and in the same direction
 - E. the same as \vec{B}_0
- ans: B
52. Ferromagnetism is closely associated with:
- A. the tendency of electron dipole moments to align with an applied magnetic field
 - B. the tendency of electron dipole moments to align opposite to an applied magnetic field
 - C. the tendency of electron dipole moments to change magnitude in an applied magnetic field
 - D. the tendency of electron dipole moments to align with each other
 - E. the force exerted by electron dipole moments on each other
- ans: D
53. Of the three chief kinds of magnetic materials (diamagnetic, paramagnetic, and ferromagnetic), which are used to make permanent magnets?
- A. Only diamagnetic
 - B. Only ferromagnetic
 - C. Only paramagnetic
 - D. Only paramagnetic and ferromagnetic
 - E. All three
- ans: B
54. When a permanent magnet is strongly heated:
- A. nothing happens
 - B. it becomes an induced magnet
 - C. it loses its magnetism
 - D. its magnetism increases
 - E. its polarity reverses
- ans: C
55. Magnetization vectors in neighboring ferromagnetic domains are:
- A. always in opposite directions
 - B. always in the same direction
 - C. always in different directions
 - D. sometimes in different directions and sometimes in the same direction
 - E. sometimes in opposite directions and sometimes in the same direction
- ans: C

56. The behavior of ferromagnetic domains in an applied magnetic field gives rise to:
- A. hysteresis
 - B. ferromagnetism
 - C. the Curie law
 - D. a lowering of the Curie temperature
 - E. Gauss' law for magnetism

ans: A

57. Because ferromagnets have ferromagnetic domains, the net magnetization:
- A. can never be in the same direction as an applied field
 - B. may not vanish when an applied field is reduced to zero
 - C. can never vanish
 - D. is proportional to any applied magnetic field
 - E. is always opposite to the direction of any applied magnetic field

ans: B

58. The soft iron core in the solenoid shown is removable. Then:

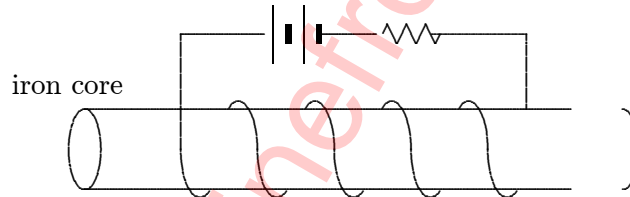

- A. the current will be larger without the core
- B. the current will be larger with the core
- C. one must do work to remove the core
- D. the circuit will do work in expelling the core
- E. the stored energy is the same with or without the core

ans: C

59. An unmagnetized steel bar is placed inside a solenoid. As the current in the solenoid is slowly increased from zero to some large value, the magnetization of the bar:
- A. increases proportionally with the current
 - B. remains zero for awhile and then increases linearly with any further increase in current
 - C. increases with increasing current at first but later is much less affected by it
 - D. is unaffected by the current
 - E. increases quadratically with the current

ans: C

60. The magnetic field of Earth is roughly the same as that of a magnetic dipole with a dipole moment of about:
- A. 10^{17} J/T
 - B. 10^{19} J/T
 - C. 10^{21} J/T
 - D. 10^{23} J/T
 - E. 10^{25} J/T
- ans: D
61. Of the following places, one would expect that the horizontal component of Earth's magnetic field is largest in:
- A. Maine
 - B. Florida
 - C. Maryland
 - D. New York
 - E. Iowa
- ans: B
62. A positively charged ion, due to a cosmic ray, is headed through Earth's atmosphere toward the center of Earth. Due to Earth's magnetic field, the ion will be deflected:
- A. south
 - B. north
 - C. west
 - D. east
 - E. not at all since it is a charge and not a pole
- ans: D
63. Maxwell's great contribution to electromagnetic theory was his hypothesis that:
- A. work is required to move a magnetic pole through a closed path surrounding a current
 - B. a time-varying electric flux acts as a current for purposes of producing a magnetic field
 - C. the speed of light could be determined from simple electrostatic and magnetostatic experiments (finding the values of μ_0 and ϵ_0)
 - D. the magnetic force on a moving charge particle is perpendicular to both \vec{v} and \vec{B}
 - E. magnetism could be explained in terms of circulating currents in atoms
- ans: B
64. Displacement current is:
- A. $d\Phi_E/dt$
 - B. $\epsilon_0 d\Phi_E/dt$
 - C. $\mu_0 d\Phi_E/dt$
 - D. $\mu_0 \epsilon_0 d\Phi_E/dt$
 - E. $-d\Phi_B/dt$
- ans: B

65. Displacement current exists wherever there is:
- a magnetic field
 - moving charge
 - a changing magnetic field
 - an electric field
 - a changing electric field

ans: E

66. Displacement current exists in the region between the plates of a parallel plate capacitor if:
- the capacitor leaks charge across the plates
 - the capacitor is being discharged
 - the capacitor is fully charged
 - the capacitor is fully discharged
 - none of the above are true

ans: B

67. An electric field exists in the cylindrical region shown and is parallel to the cylinder axis. The magnitude of the field might vary with time according to any of the four graphs shown. Rank the four variations according to the magnitudes of the magnetic field induced at the edge of the region, least to greatest.

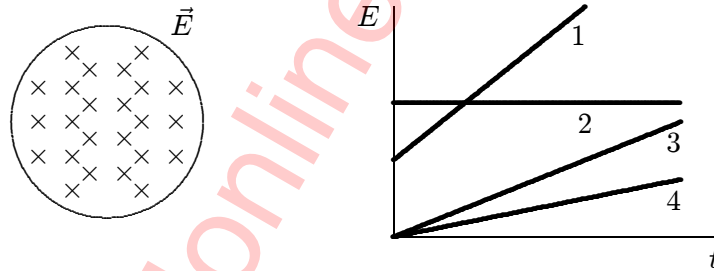

- 2, 4, 3, 1
- 3 and 4 tie, then 1, 2
- 4, 3, 2, 1
- 4, 3, 1, 2
- 2, 1, 3, 4

ans: A

68. The diagram shows one plate of a parallel-plate capacitor from within the capacitor. The plate is circular and has radius R . The dashed circles are four integration paths and have radii of $r_1 = R/4$, $r_2 = R/2$, $r_3 = 3R/2$, and $r_4 = 2R$. Rank the paths according to the magnitude of $\oint \vec{B} \cdot d\vec{s}$ around the paths during the discharging of the capacitor, least to greatest.

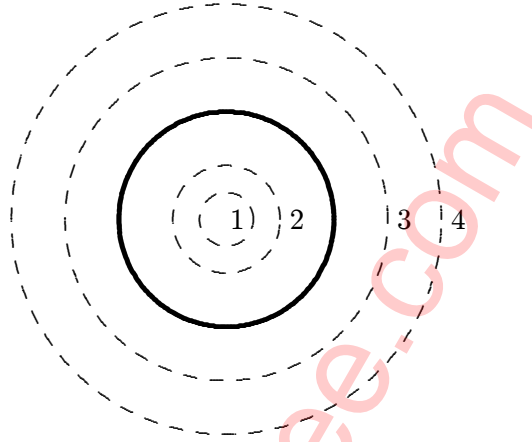

- A. 1, 2 and 3 tie, then 4
 B. 1, 2, 3, 4
 C. 1, 2, 3 and 4 tie
 D. 4, 3, 1, 2
 E. all tie
 ans: C
69. A 1.2-m radius cylindrical region contains a uniform electric field along the cylinder axis. It is increasing uniformly with time. To obtain a total displacement current of 2.0×10^{-9} A through a cross section of the region, the magnitude of the electric field should change at a rate of:
- A. $5.0 \text{ V/m} \cdot \text{s}$
 B. $12 \text{ V/m} \cdot \text{s}$
 C. $37 \text{ V/m} \cdot \text{s}$
 D. $50 \text{ V/m} \cdot \text{s}$
 E. $4.0 \times 10^7 \text{ V/m} \cdot \text{s}$
 ans: D
70. A current of 1 A is used to charge a parallel plate capacitor with square plates. If the area of each plate is 0.6 m^2 the displacement current through a 0.3 m^2 area wholly between the capacitor plates and parallel to them is:
- A. 1 A
 B. 2 A
 C. 0.7 A
 D. 0.5 A
 E. 0.25 A
 ans: D

71. A $1\text{-}\mu\text{F}$ capacitor is connected to an emf that is increasing uniformly with time at a rate of 100 V/s . The displacement current between the plates is:
- A. 0
 - B. $1 \times 10^{-8}\text{ A}$
 - C. $1 \times 10^{-6}\text{ A}$
 - D. $1 \times 10^{-4}\text{ A}$
 - E. 100 A
- ans: D
72. A magnetic field exists between the plates of a capacitor:
- A. always
 - B. never
 - C. when the capacitor is fully charged
 - D. while the capacitor is being charged
 - E. only when the capacitor is starting to be charged
- ans: D
73. Suppose you are looking into one end of a long cylindrical tube in which there is a uniform electric field, pointing away from you. If the magnitude of the field is decreasing with time the direction of the induced magnetic field is:
- A. toward you
 - B. away from you
 - C. clockwise
 - D. counterclockwise
 - E. to your right
- ans: D
74. Suppose you are looking into one end of a long cylindrical tube in which there is a uniform electric field, pointing away from you. If the magnitude of the field is decreasing with time the field lines of the induced magnetic field are:
- A. circles
 - B. ellipses
 - C. straight lines parallel to the electric field
 - D. straight lines perpendicular to the electric field
 - E. none of the above
- ans: A
75. A cylindrical region contains a uniform electric field that is along the cylinder axis and is changing with time. If r is distance from the cylinder axis the magnitude of the magnetic field within the region is:
- A. uniform
 - B. proportional to $1/r$
 - C. proportional to r^2
 - D. proportional to $1/r^2$
 - E. proportional to r
- ans: E

76. A cylindrical region contains a uniform electric field that is parallel to the axis and is changing with time. If r is distance from the cylinder axis the magnitude of the magnetic field outside the region is:
- A. 0
 - B. proportional to $1/r$
 - C. proportional to r^2
 - D. proportional to $1/r^2$
 - E. proportional to r
- ans: B
77. A 0.70-m radius cylindrical region contains a uniform electric field that is parallel to the axis and is decreasing at the rate $5.0 \times 10^{12} \text{ V/m} \cdot \text{s}$. The magnetic field at a point 0.25 m from the axis has a magnitude of:
- A. 0
 - B. $7.0 \times 10^{-6} \text{ T}$
 - C. $2.8 \times 10^{-5} \text{ T}$
 - D. $5.4 \times 10^{-5} \text{ T}$
 - E. $7.0 \times 10^{-5} \text{ T}$
- ans: B
78. A 0.70-m radius cylindrical region contains a uniform electric field that is parallel to the axis and is decreasing at the rate $5.0 \times 10^{12} \text{ V/m} \cdot \text{s}$. The magnetic field at a point 1.2 m from the axis has a magnitude of:
- A. 0
 - B. $7.0 \times 10^{-6} \text{ T}$
 - C. $1.1 \times 10^{-5} \text{ T}$
 - D. $2.3 \times 10^{-5} \text{ T}$
 - E. $2.8 \times 10^{-5} \text{ T}$
- ans: C
79. A 1-A current is used to charge a parallel plate capacitor. A large square piece of paper is placed between the plates and parallel to them so it sticks out on all sides. The value of the integral $\oint \vec{B} \cdot d\vec{s}$ around the perimeter of the paper is:
- A. $2 \text{ T} \cdot \text{m}$
 - B. $4\pi \times 10^{-7} \text{ T} \cdot \text{m}$
 - C. $8.85 \times 10^{-12} \text{ T} \cdot \text{m}$
 - D. $10^{-7} \text{ T} \cdot \text{m}$
 - E. not determined from the given quantities
- ans: B
80. A sinusoidal emf is connected to a parallel plate capacitor. The magnetic field between the plates is:
- A. 0
 - B. constant
 - C. sinusoidal and its amplitude does not depend on the frequency of the source
 - D. sinusoidal and its amplitude is proportional to the frequency of the source
 - E. sinusoidal and its amplitude is inversely proportional to the frequency of the source
- ans: D

81. An electron is on the z axis moving toward the xy plane but it has not reached that plane yet. At that instant:
- A. there is only a true current through the xy plane
 - B. there is only a displacement current through the xy plane
 - C. there are both true and displacement currents through the xy plane
 - D. there is neither a true nor a displacement current through the xy plane
 - E. none of the above are true

ans: B

www.allonlinefree.com

Chapter 33: ELECTROMAGNETIC WAVES

- Select the correct statement:
 - ultraviolet light has a longer wavelength than infrared
 - blue light has a higher frequency than x rays
 - radio waves have higher frequency than gamma rays
 - gamma rays have higher frequency than infrared waves
 - electrons are a type of electromagnetic waveans: D
- Consider: radio waves (r), visible light (v), infrared light (i), x-rays (x), and ultraviolet light (u). In order of increasing frequency, they are:
 - r, v, i, x, u
 - r, i, v, u, x
 - i, r, v, u, x
 - i, v, r, u, x
 - r, i, v, x, uans: B
- The order of increasing wavelength for blue (b), green (g), red (r), and yellow (y) light is:
 - r, y, g, b
 - r, g, y, b
 - g, y, b, r
 - b, g, y, r
 - b, y, g, rans: D
- Of the following human eyes are most sensitive to:
 - red light
 - violet light
 - blue light
 - green light
 - none of these (they are equally sensitive to all colors)ans: D
- Which of the following is NOT true for electromagnetic waves?
 - they consist of changing electric and magnetic fields
 - they travel at different speeds in vacuum, depending on their frequency
 - they transport energy
 - they transport momentum
 - they can be reflectedans: B

6. The product $\mu_0\epsilon_0$ has the same units as:

- A. (velocity)²
- B. (velocity)^{1/2}
- C. 1/velocity
- D. 1/velocity²
- E. 1/velocity^{1/2}

ans: D

7. Maxwell's equations predict that the speed of electromagnetic waves in free space is given by:

- A. $\mu_0\epsilon_0$
- B. $(\mu_0\epsilon_0)^{1/2}$
- C. $1/\mu_0\epsilon_0$
- D. $1/(\mu_0\epsilon_0)^{1/2}$
- E. $1/(\mu_0\epsilon_0)^2$

ans: D

8. Maxwell's equations predict that the speed of light in free space is

- A. an increasing function of frequency
- B. a decreasing function of frequency
- C. independent of frequency
- D. a function of the distance from the source
- E. a function of the size of the source

ans: C

9. The speed of light in vacuum is about:

- A. 1100 ft/s
- B. 93×10^6 m/s
- C. 6×10^{23} m/s
- D. 3×10^{10} cm/s
- E. 186,000 mph

ans: D

10. The Sun is about 1.5×10^{11} m away. The time for light to travel this distance is about:

- A. 4.5×10^{18} s
- B. 8 s
- C. 8 min
- D. 8 hr
- E. 8 yr

ans: C

11. The time for a radar signal to travel to the Moon and back, a one-way distance of about 3.8×10^8 m, is:
- A. 1.3 s
 - B. 2.5 s
 - C. 8 s
 - D. 8 min
 - E. 1×10^6 s
- ans: B
12. Which of the following types of electromagnetic radiation travels at the greatest speed in vacuum?
- A. Radio waves
 - B. Visible light
 - C. X rays
 - D. Gamma rays
 - E. All of these travel at the same speed
- ans: E
13. Radio waves differ from visible light waves in that radio waves:
- A. travel slower
 - B. have a higher frequency
 - C. travel faster
 - D. have a lower frequency
 - E. require a material medium
- ans: D
14. Visible light has a frequency of about:
- A. 5×10^{18} Hz
 - B. 5×10^{16} Hz
 - C. 5×10^{14} Hz
 - D. 5×10^{12} Hz
 - E. 5×10^{10} Hz
- ans: C
15. The theoretical upper limit for the frequency of electromagnetic waves is:
- A. just slightly greater than that of red light
 - B. just slightly less than that of blue light
 - C. the greatest x-ray frequency
 - D. none of the above (there is no upper limit)
 - E. none of the above (but there is an upper limit)
- ans: D

16. Radio waves of wavelength 3 cm have a frequency of:
- A. 1 MHz
 - B. 9 MHz
 - C. 100 MHz
 - D. 10,000 MHz
 - E. 900 MHz
- ans: D
17. Radio waves of wavelength 300 m have a frequency of:
- A. 10^{-3} kHz
 - B. 500 kHz
 - C. 1 MHz
 - D. 9 MHz
 - E. 108 kHz
- ans: C
18. If the electric field in a plane electromagnetic wave is given by $E_m \sin[(3 \times 10^6 \text{ m}^{-1})x - \omega t]$, the value of ω is:
- A. 0.01 rad/s
 - B. 10 rad/s
 - C. 100 rad/s
 - D. 9×10^{14} rad/s
 - E. 9×10^{16} rad/s
- ans: D
19. An electromagnetic wave is generated by:
- A. any moving charge
 - B. any accelerating charge
 - C. only a charge with changing acceleration
 - D. only a charge moving in a circle
 - E. only a charge moving in a straight line
- ans: B

20. The electric field for a plane electromagnetic wave traveling in the $+y$ direction is shown. Consider a point where \vec{E} is in the $+z$ direction. The \vec{B} field is:

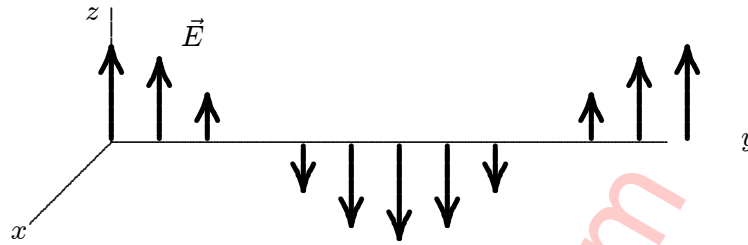

- A. in the $+x$ direction and in phase with the \vec{E} field
- B. in the $-x$ direction and in phase with the \vec{E} field
- C. in the $+x$ direction and one-fourth of a cycle out of phase with the \vec{E} field
- D. in the $+z$ direction and in phase with the \vec{E} field
- E. in the $+z$ direction and one-fourth of a cycle out of phase with the \vec{E} field

ans: A

21. A plane electromagnetic wave is traveling in the positive x direction. At the instant shown the electric field at the extremely narrow dashed rectangle is in the negative z direction and its magnitude is decreasing. Which diagram correctly shows the directions and relative magnitudes of the magnetic field at the edges of the rectangle?

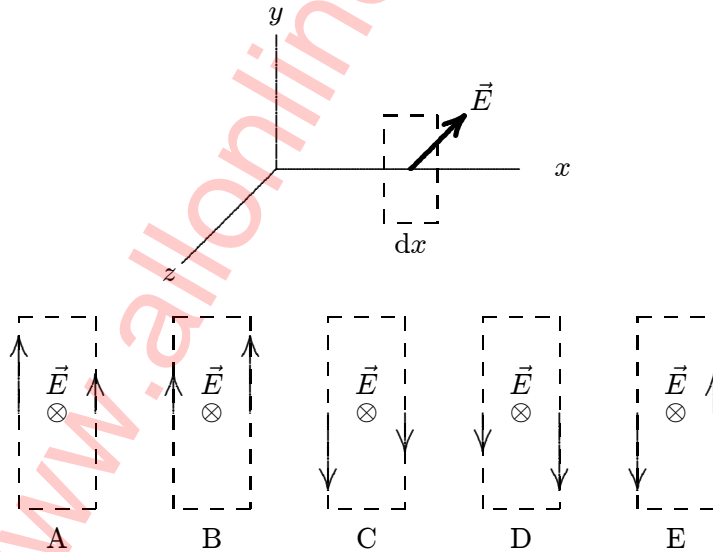

ans: B

22. In a plane electromagnetic wave in vacuum, the ratio E/B of the amplitudes in SI units of the two fields is:
- A. the speed of light
 - B. an increasing function of frequency
 - C. a decreasing function of frequency
 - D. $\sqrt{2}$
 - E. $1/\sqrt{2}$

ans: A

23. If the magnetic field in a plane electromagnetic wave is along the y axis and its component is given by $B_m \sin(kx - \omega t)$, in SI units, then the electric field is along the z axis and its component is given by:
- $(cB_m) \cos(kx - \omega t)$
 - $-(cB_m/c) \cos(kx - \omega t)$
 - $-(cB_m/c) \sin(kx - \omega t)$
 - $B_m \cos(kx - \omega t)$
 - $(cB_m/c) \sin(kx - \omega t)$
- ans: E
24. If the electric field in a plane electromagnetic wave is along the y axis and its component is given by $E_m \sin(kx + \omega t)$, in SI units, then the magnetic field is along the z axis and its component is given by:
- $(E_m/c) \cos(kx + \omega t)$
 - $-(E_m/c) \cos(kx + \omega t)$
 - $-(E_m/c) \sin(kx + \omega t)$
 - $E_m \cos(kx + \omega t)$
 - $(E_m/c) \sin(kx + \omega t)$
- ans: C
25. An electromagnetic wave is traveling in the positive x direction with its electric field along the z axis and its magnetic field along the y axis. The fields are related by:
- $\partial E/\partial x = \mu_0 \epsilon_0 \partial B/\partial x$
 - $\partial E/\partial x = \mu_0 \epsilon_0 \partial B/\partial t$
 - $\partial B/\partial x = \mu_0 \epsilon_0 \partial E/\partial x$
 - $\partial B/\partial x = \mu_0 \epsilon_0 \partial E/\partial t$
 - $\partial B/\partial x = -\mu_0 \epsilon_0 \partial E/\partial t$
- ans: E
26. If the amplitude of the electric field in a plane electromagnetic wave is 100 V/m then the amplitude of the magnetic field is:
- $3.3 \times 10^{-7} \text{ T}$
 - $6.7 \times 10^{-7} \text{ T}$
 - 0.27 T
 - $8.0 \times 10^7 \text{ T}$
 - $3.0 \times 10^9 \text{ T}$
- ans: A
27. For an electromagnetic wave the direction of the vector $\vec{E} \times \vec{B}$ gives:
- the direction of the electric field
 - the direction of the magnetic field
 - the direction of wave propagation
 - the direction of the electromagnetic force on a proton
 - the direction of the emf induced by the wave
- ans: C

28. The dimensions of $\vec{S} = (1/\mu_0)\vec{E} \times \vec{B}$ are:
- A. J/m^2
 - B. J/s
 - C. W/s
 - D. W/m^2
 - E. J/m^3
- ans: D
29. The time-averaged energy in a sinusoidal electromagnetic wave is:
- A. overwhelmingly electrical
 - B. slightly more electrical than magnetic
 - C. equally divided between the electric and magnetic fields
 - D. slightly more magnetic than electrical
 - E. overwhelmingly magnetic
- ans: C
30. At a certain point and a certain time the electric field of an electromagnetic wave is in the negative z direction and the magnetic field is in the positive y direction. Which of the following statements is true?
- A. Energy is being transported in the positive x direction but half a cycle later, when the electric field is in the opposite direction, it will be transported in the negative x direction
 - B. Energy is being transported in the positive x direction and half a cycle later, when the electric field is in the opposite direction, it will still be transported in the positive x direction
 - C. Energy is being transported in the negative x direction but half a cycle later, when the electric field is in the opposite direction, it will be transported in the positive x direction
 - D. Energy is being transported in the negative x direction and half a cycle later, when the electric field is in the opposite direction, it will still be transported in the negative x direction
 - E. None of the above are true
- ans: B
31. An electromagnetic wave is transporting energy in the negative y direction. At one point and one instant the magnetic field is in the positive x direction. The electric field at that point and instant is:
- A. positive y direction
 - B. negative y direction
 - C. positive z direction
 - D. negative z direction
 - E. negative x direction
- ans: D

32. A point source emits electromagnetic energy at a rate of 100 W. The intensity 10 m from the source is:
- A. 10 W/m^2
 - B. 1.6 W/m^2
 - C. 1 W/m^2
 - D. 0.024 W/m^2
 - E. 0.080 W/m^2
- ans: E
33. The light intensity 10 m from a point source is 1000 W/m^2 . The intensity 100 m from the same source is:
- A. 1000 W/m^2
 - B. 100 W/m^2
 - C. 10 W/m^2
 - D. 1 W/m^2
 - E. 0.1 W/m^2
- ans: C
34. When the distance between a point source of light and a light meter is reduced from 6.0 m to 2.0 m, the intensity of illumination at the meter will be the original value multiplied by:
- A. 3
 - B. 9
 - C. $1/3$
 - D. $1/9$
 - E. 1
- ans: A
35. The magnetic field in a sinusoidal light wave has an amplitude of $3.3 \times 10^{-7} \text{ T}$. The intensity of the wave is:
- A. $1.7 \times 10^{-4} \text{ W/m}^2$
 - B. 13 W/m^2
 - C. 27 W/m^2
 - D. $1.0 \times 10^5 \text{ W/m}^2$
 - E. $4.0 \times 10^{10} \text{ W/m}^2$
- ans: B
36. A sinusoidal electromagnetic wave with an electric field amplitude of 100 V/m is incident normally on a surface with an area of 1 cm^2 and is completely absorbed. The energy absorbed in 10 s is:
- A. 1.3 mJ
 - B. 13 mJ
 - C. 27 mJ
 - D. 130 mJ
 - E. 270 mJ
- ans: B

37. Evidence that electromagnetic waves carry momentum is:
- A. the tail of a comet points away from the Sun
 - B. electron flow through a wire generates heat
 - C. a charged particle in a magnetic field moves in a circular orbit
 - D. heat can be generated by rubbing two sticks together
 - E. the Doppler effect
- ans: A
38. Light of uniform intensity shines perpendicularly on a totally absorbing surface, fully illuminating the surface. If the area of the surface is decreased:
- A. the radiation pressure increases and the radiation force increases
 - B. the radiation pressure increases and the radiation force decreases
 - C. the radiation pressure stays the same and the radiation force increases
 - D. the radiation pressure stays the same and the radiation force decreases
 - E. the radiation pressure decreases and the radiation force decreases
- ans: D
39. Light with an intensity of 1 kW/m^2 falls normally on a surface and is completely absorbed. The radiation pressure is:
- A. 1 kPa
 - B. $3 \times 10^{11} \text{ Pa}$
 - C. $1.7 \times 10^{-6} \text{ Pa}$
 - D. $3.3 \times 10^{-6} \text{ Pa}$
 - E. $6.7 \times 10^{-6} \text{ Pa}$
- ans: D
40. Light with an intensity of 1 kW/m^2 falls normally on a surface and is completely reflected. The radiation pressure is:
- A. 1 kPa
 - B. $3 \times 10^{11} \text{ Pa}$
 - C. $1.7 \times 10^{-6} \text{ Pa}$
 - D. $3.3 \times 10^{-6} \text{ Pa}$
 - E. $6.7 \times 10^{-6} \text{ Pa}$
- ans: E
41. Light with an intensity of 1 kW/m^2 falls normally on a surface with an area of 1 cm^2 and is completely absorbed. The force of the radiation on the surface is:
- A. $1.0 \times 10^{-4} \text{ N}$
 - B. $3.3 \times 10^{-11} \text{ N}$
 - C. $1.7 \times 10^{-10} \text{ N}$
 - D. $3.3 \times 10^{-10} \text{ N}$
 - E. $6.7 \times 10^{-10} \text{ N}$
- ans: D

42. Light with an intensity of 1 kW/m^2 falls normally on a surface with an area of 1 cm^2 and is completely reflected. The force of the radiation on the surface is:
- A. $1.0 \times 10^{-4} \text{ N}$
 - B. $3.3 \times 10^{-11} \text{ N}$
 - C. $1.7 \times 10^{-10} \text{ N}$
 - D. $3.3 \times 10^{-10} \text{ N}$
 - E. $6.7 \times 10^{-10} \text{ N}$
- ans: E
43. A company claims to have developed material that absorbs light energy without a transfer of momentum. Such material is:
- A. impossible
 - B. possible, but very expensive
 - C. inexpensive and already in common use
 - D. in use by NASA but is not commercially available
 - E. a breakthrough in high technology
- ans: A
44. Polarization experiments provide evidence that light is:
- A. a longitudinal wave
 - B. a stream of particles
 - C. a transverse wave
 - D. some type of wave
 - E. nearly monochromatic
- ans: C
45. A vertical automobile radio antenna is sensitive to electric fields that are polarized:
- A. horizontally
 - B. in circles around the antenna
 - C. vertically
 - D. normal to the antenna in the forward direction
 - E. none of the above
- ans: C
46. For linearly polarized light the plane of polarization is:
- A. perpendicular to both the direction of polarization and the direction of propagation
 - B. perpendicular to the direction of polarization and parallel to the direction of propagation
 - C. parallel to the direction of polarization and perpendicular to the direction of propagation
 - D. parallel to both the direction of polarization and the direction of propagation
 - E. none of the above
- ans: D

47. Light from any ordinary source (such as a flame) is usually:
- A. unpolarized
 - B. plane polarized
 - C. circularly polarized
 - D. elliptically polarized
 - E. monochromatic

ans: A

48. The electric field in unpolarized light:
- A. has no direction at any time
 - B. rotates rapidly
 - C. is always parallel to the direction of propagation
 - D. changes direction randomly and often
 - E. remains along the same line but reverses direction randomly and often

ans: D

49. The diagrams show four pairs of polarizing sheets, with the polarizing directions indicated by dashed lines. The two sheets of each pair are placed one behind the other and the front sheet is illuminated by unpolarized light. The incident intensity is the same for all pairs of sheets. Rank the pairs according to the intensity of the transmitted light, least to greatest.

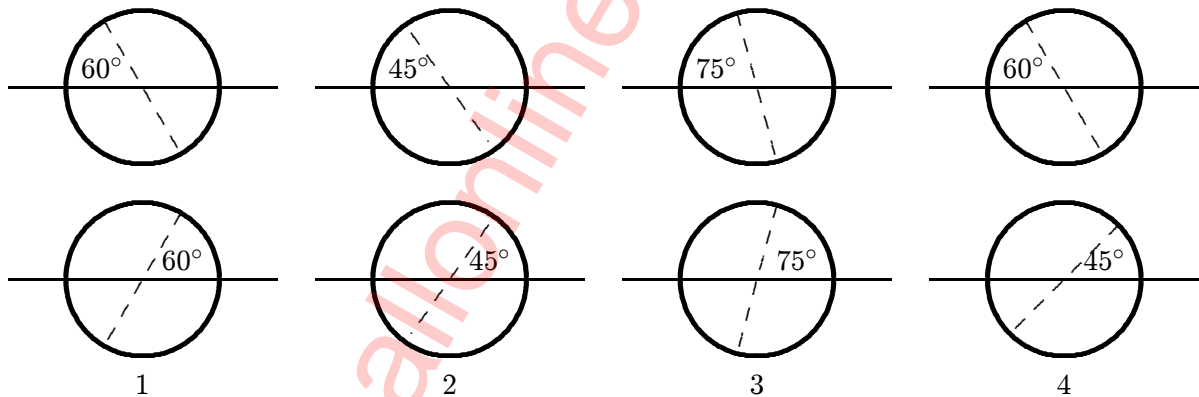

- A. 1, 2, 3, 4
- B. 4, 2, 1, 3
- C. 2, 4, 3, 1
- D. 2, 4, 1, 3
- E. 3, 1, 4, 2

ans: D

50. A clear sheet of polaroid is placed on top of a similar sheet so that their polarizing axes make an angle of 30° with each other. The ratio of the intensity of emerging light to incident unpolarized light is:
- A. 1 : 4
 - B. 1 : 3
 - C. 1 : 2
 - D. 3 : 4
 - E. 3 : 8
- ans: E
51. An unpolarized beam of light has intensity I_0 . It is incident on two ideal polarizing sheets. The angle between the axes of polarization of these sheets is θ . Find θ if the emerging light has intensity $I_0/4$:
- A. $\sin^{-1}(1/2)$
 - B. $\sin^{-1}(1/\sqrt{5})$
 - C. $\cos^{-1}(1/2)$
 - D. $\cos^{-1}(1/\sqrt{2})$
 - E. $\tan^{-1}(1/4)$
- ans: D
52. In a stack of three polarizing sheets the first and third are crossed while the middle one has its axis at 45° to the axes of the other two. The fraction of the intensity of an incident unpolarized beam of light that is transmitted by the stack is:
- A. 1/2
 - B. 1/3
 - C. 1/4
 - D. 1/8
 - E. 0
- ans: D
53. Three polarizing sheets are placed in a stack with the polarizing directions of the first and third perpendicular to each other. What angle should the polarizing direction of the middle sheet make with the polarizing direction of the first sheet to obtain maximum transmitted intensity when unpolarized light is incident on the stack?
- A. 0
 - B. 30°
 - C. 45°
 - D. 60°
 - E. 90°
- ans: C

54. Three polarizing sheets are placed in a stack with the polarizing directions of the first and third perpendicular to each other. What angle should the polarizing direction of the middle sheet make with the polarizing direction of the first sheet to obtain zero transmitted intensity when unpolarized light is incident on the stack?
- A. 0
 - B. 30°
 - C. 45°
 - D. 60°
 - E. All angles allow light to pass through
- ans: A
55. The relation $\theta_{\text{incident}} = \theta_{\text{reflected}}$, which applies as a ray of light strikes an interface between two media, is known as:
- A. Faraday's law
 - B. Snell's law
 - C. Ampere's law
 - D. Cole's law
 - E. none of these
- ans: E
56. The relation $n_1 \sin \theta_1 = n_2 \sin \theta_2$, which applies as a ray of light strikes an interface between two media, is known as:
- A. Gauss' law
 - B. Snell's law
 - C. Faraday's law
 - D. Cole's law
 - E. law of sines
- ans: B
57. As used in the laws of reflection and refraction, the "normal" direction is:
- A. any convenient direction
 - B. tangent to the interface
 - C. along the incident ray
 - D. perpendicular to the electric field vector of the light
 - E. perpendicular to the interface
- ans: E
58. When an electromagnetic wave meets a reflecting surface, the direction taken by the reflected wave is determined by:
- A. the material of the reflecting surface
 - B. the angle of incidence
 - C. the index of the medium
 - D. the intensity of the wave
 - E. the wavelength
- ans: B

59. The index of refraction of a substance is:
- A. the speed of light in the substance
 - B. the angle of refraction
 - C. the angle of incidence
 - D. the speed of light in vacuum divided by the speed of light in the substance
 - E. measured in radians

ans: D

60. The units of index of refraction are:

- A. m/s
- B. s/m
- C. radian
- D. m/s^2
- E. none of these

ans: E

61. The diagram shows the passage of a ray of light from air into a substance X. The index of refraction of X is:

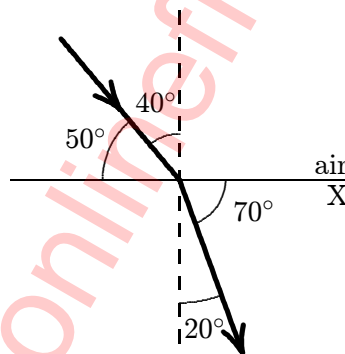

- A. 0.53
- B. 0.88
- C. 1.9
- D. 2.2
- E. 3.0

ans: C

62. If $n_{\text{water}} = 1.33$, what is the angle of refraction for the ray shown?

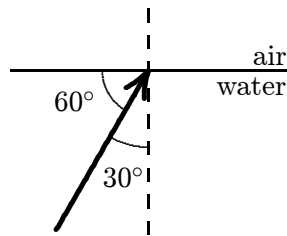

- A. 19°
- B. 22°
- C. 36°
- D. 42°
- E. 48°

ans: D

63. Which diagram below illustrates the path of a light ray as it travels from a given point X in air to another given point Y in glass?

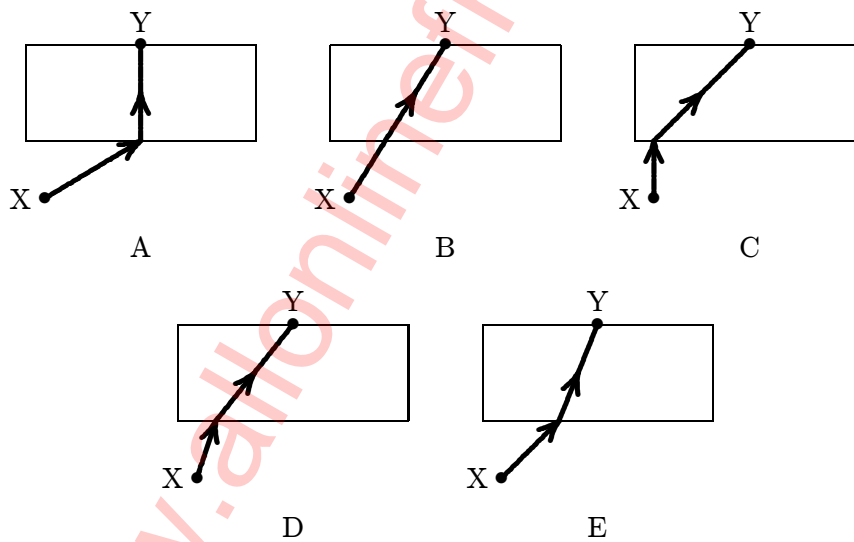

ans: E

64. The index of refraction for diamond is 2.5. Which of the following is correct for the situation shown?

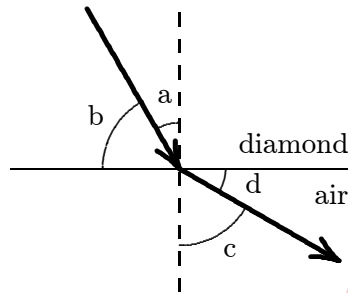

- A. $(\sin a)/(\sin b) = 2.5$
 B. $(\sin b)/(\sin d) = 2.5$
 C. $(\cos a)/(\cos c) = 2.5$
 D. $(\sin c)/(\sin a) = 2.5$
 E. $a/c = 2.5$

ans: D

65. When light travels from medium X to medium Y as shown:

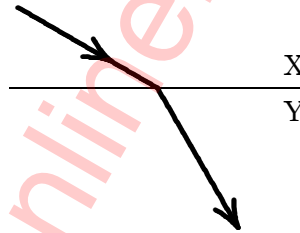

- A. both the speed and the frequency decrease
 B. both the speed and the frequency increase
 C. both the speed and the wavelength decrease
 D. both the speed and the wavelength increase
 E. both the wavelength and the frequency are unchanged

ans: C

66. A ray of light passes obliquely through a plate of glass having parallel faces. The emerging ray:

- A. is totally internally reflected
 B. is bent more toward the normal than the incident ray
 C. is bent further away from the normal than the incident ray
 D. is parallel to the incident ray but displaced sideways
 E. lies on the same straight line as the incident ray

ans: D

67. When light passes from air to glass, it bends:
- A. toward the normal without changing speed
 - B. toward the normal and slows down
 - C. toward the normal and speeds up
 - D. away from the normal and slows down
 - E. away from the normal and speeds up

ans: B

68. A ray of light passes through three media as shown. The speed of light in these media obey:

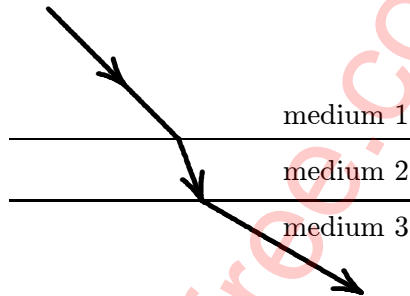

- A. $v_1 > v_2 > v_3$
- B. $v_3 > v_2 > v_1$
- C. $v_3 > v_1 > v_2$
- D. $v_2 > v_1 > v_3$
- E. $v_1 > v_3 > v_2$

ans: C

69. As light goes from one medium to another, it is bent away from the normal. Then:
- A. the speed of the light has increased
 - B. dispersion must occur
 - C. the second medium has a higher index of refraction than the first
 - D. no change in speed has occurred
 - E. refraction has not occurred because refraction means a bending toward the normal

ans: A

70. A pole stands in a river, half in and half out of the water. Another pole of the same length stands vertically on the shore at a place where the ground is level. The shadow cast by the pole in the river on the river bottom is:
- A. slightly longer than the shadow of the pole on land
 - B. much longer than the shadow of the pole on land
 - C. shorter than the shadow of the pole on land
 - D. shorter than the shadow of the pole on land if the Sun is high and longer if the sun is low
 - E. the same length as the shadow of the pole on land

ans: C

71. The rectangular metal tank shown is filled with an unknown liquid. The observer, whose eye is level with the top of the tank, can just see corner E. The index of refraction of this liquid is:

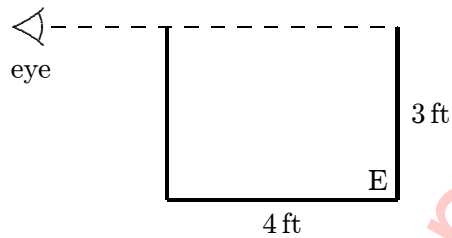

- A. 1.75
B. 1.67
C. 1.50
D. 1.33
E. 1.25
ans: E
72. The index of refraction of benzene is 1.80. The critical angle for total internal reflection, at a benzene-air interface, is about:
A. 56°
B. 47°
C. 34°
D. 22°
E. 18°
ans: C
73. The index of refraction of a certain glass is 1.50. The sine of the critical angle for total internal reflection at a glass-air interface is:
A. 0.50
B. 0.67
C. 0.75
D. 1.00
E. 1.50
ans: B

74. The illustration shows total internal reflection taking place in a piece of glass. The index of refraction of this glass:

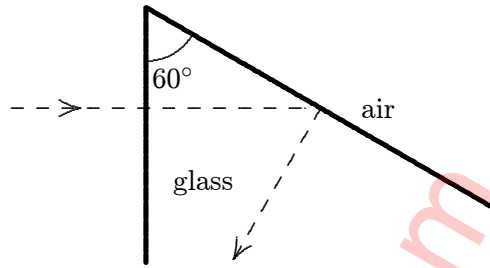

- A. is at least 2.0
 B. is at most 2.0
 C. is at least 1.15
 D. is at most 1.15
 E. cannot be calculated from the given data
 ans: C
75. The critical angle for total internal reflection at a diamond-air interface is 25° . Suppose light is incident at an angle of θ with the normal. Total internal reflection will occur if the incident medium is:
 A. air and $\theta = 25^\circ$
 B. air and $\theta > 25^\circ$
 C. air and $\theta < 25^\circ$
 D. diamond and $\theta < 25^\circ$
 E. diamond and $\theta > 25^\circ$
 ans: E
76. If $n_{\text{water}} = 1.50$ and $n_{\text{glass}} = 1.33$, then total internal reflection at an interface between this glass and water:
 A. occurs whenever the light goes from glass to water
 B. occurs whenever the light goes from water to glass
 C. may occur when the light goes from glass to water
 D. may occur when the light goes from water to glass
 E. can never occur at this interface
 ans: D
77. The separation of white light into colors by a prism is associated with:
 A. total internal reflection
 B. partial reflection from each surface
 C. variation of index of refraction with wavelength
 D. a decrease in the speed of light in the glass
 E. selective absorption of various colors
 ans: C

78. The diagram shows total internal reflection. Which of the following statements is NOT true?

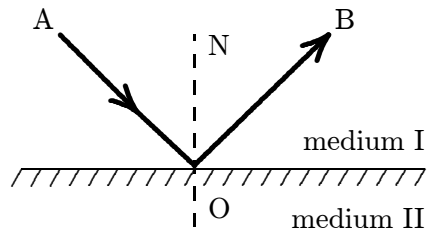

- A. Angle AON is the angle of incidence
 - B. Angle AON = angle BON
 - C. Angle AON must be the critical angle
 - D. The speed of light in medium II is greater than that in medium I
 - E. if angle AON were increased, there would still be total internal reflection
- ans: C
79. A ray of light in water (index n_1) is incident on its surface (with air) at the critical angle for total internal reflection. Some oil (index n_2) is now floated on the water. The angle between the ray in the oil and the normal is:
- A. $\sin^{-1}(1.00)$
 - B. $\sin^{-1}(1/n_1)$
 - C. $\sin^{-1}(1/n_2)$
 - D. $\sin^{-1}(n_1/n_2)$
 - E. $\sin^{-1}(n_2/n_1)$

ans: C

Chapter 34: IMAGES

1. A virtual image is one:
 - A. toward which light rays converge but do not pass through
 - B. from which light rays diverge but do not pass through
 - C. from which light rays diverge as they pass through
 - D. toward which light rays converge and pass through
 - E. with a ray normal to a mirror passing through itans: B
2. Which of the following is true of all virtual images?
 - A. They can be seen but not photographed
 - B. They are ephemeral
 - C. They are smaller than the objects
 - D. They are larger than the objects
 - E. None of the aboveans: E
3. When you stand in front of a plane mirror, your image is:
 - A. real, erect, and smaller than you
 - B. real, erect, and the same size as you
 - C. virtual, erect, and smaller than you
 - D. virtual, erect, and the same size as you
 - E. real, inverted, and the same size as youans: D
4. An object is 2 m in front of a plane mirror. Its image is:
 - A. virtual, inverted, and 2 m behind the mirror
 - B. virtual, inverted, and 2 m in front of the mirror
 - C. virtual, erect, and 2 m in front of the mirror
 - D. real, erect, and 2 m behind the mirror
 - E. none of the aboveans: E
5. A ball is held 50 cm in front of a plane mirror. The distance between the ball and its image is:
 - A. 100 cm
 - B. 150 cm
 - C. 200 cm
 - D. 0
 - E. 50 cmans: A

6. A card marked IAHIO8 is standing upright in front of a plane mirror. Which of the following is NOT true?
- A. The image is virtual
 - B. The image shifts its position as the observer shifts his position
 - C. The image appears as 80IHAI to a person looking in the mirror
 - D. The image is caused mostly by specular rather than diffuse reflection
 - E. The image is the same size as the object

ans: B

7. The angle between a horizontal ruler and a vertical plane mirror is 30° . The angle between the ruler and its image is:
- A. 15°
 - B. 30°
 - C. 60°
 - D. 90°
 - E. 180°

ans: C

8. A 5.0-ft woman wishes to see a full length image of herself in a plane mirror. The minimum length mirror required is:
- A. 5 ft
 - B. 10 ft
 - C. 2.5 ft
 - D. 3.54 ft
 - E. variable: the farther away she stands the smaller the required mirror length

ans: C

9. A man holds a rectangular card in front of and parallel to a plane mirror. In order for him to see the entire image of the card, the least mirror area needed is:
- A. that of the whole mirror, regardless of its size
 - B. that of the pupil of his eye
 - C. one-half that of the card
 - D. one-fourth that of the card
 - E. an amount which decreases with his distance from the mirror

ans: D

10. A light bulb burns in front of the center of a 40-cm wide plane mirror that is hung vertically on a wall. A man walks in front of the mirror along a line that is parallel to the mirror and twice as far from it as the bulb. The greatest distance he can walk and still see the image of the bulb is:
- A. 20 cm
 - B. 40 cm
 - C. 60 cm
 - D. 80 cm
 - E. 120 cm

ans: E

11. A plane mirror is in a vertical plane and is rotating about a vertical axis at 100 rpm. A horizontal beam of light is incident on the mirror. The reflected beam will rotate at:
- A. 100 rpm
 - B. 141 rpm
 - C. 0 rpm
 - D. 200 rpm
 - E. 10,000 rpm
- ans: D

12. A candle C sits between two parallel mirrors, a distance $0.2d$ from mirror 1. Here d is the distance between the mirrors. Multiple images of the candle appear in both mirrors. How far behind mirror 1 are the nearest three images of the candle in that mirror?

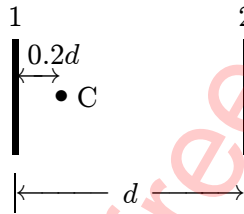

- A. $0.2d, 1.8d, 2.2d$
 - B. $0.2d, 2.2d, 4.2d$
 - C. $0.2d, 1.8d, 3.8d$
 - D. $0.2d, 0.8d, 1.4d$
 - E. $0.2d, 1.8d, 3.4d$
- ans: A
13. Two plane mirrors make an angle of 120° with each other. The maximum number of images of an object placed between them is:
- A. one
 - B. two
 - C. three
 - D. four
 - E. more than four
- ans: B
14. A parallel beam of monochromatic light in air is incident on a plane glass surface. In the glass, the beam:
- A. remains parallel
 - D. undergoes dispersion
 - B. becomes diverging
 - E. follows a parabolic path
 - C. becomes converging
- ans: A

15. The focal length of a spherical mirror is N times its radius of curvature where N is:
- A. $1/4$
 - B. $1/2$
 - C. 1
 - D. 2
 - E. 4
- ans: B
16. Real images formed by a spherical mirror are always:
- A. on the side of the mirror opposite the source
 - B. on the same side of the mirror as the source but closer to the mirror than the source
 - C. on the same side of the mirror as the source but closer to the mirror than the focal point
 - D. on the same side of the mirror as the source but further from the mirror than the focal point
 - E. none of the above
- ans: E
17. The image produced by a convex mirror of an erect object in front of the mirror is always:
- A. virtual, erect, and larger than the object
 - B. virtual, erect, and smaller than the object
 - C. real, erect, and larger than the object
 - D. real, erect, and smaller than the object
 - E. none of the above
- ans: B
18. An erect object is located between a concave mirror and its focal point. Its image is:
- A. real, erect, and larger than the object
 - B. real, inverted, and larger than the object
 - C. virtual, erect, and larger than the object
 - D. virtual, inverted, and larger than the object
 - E. virtual, erect, and smaller than the object
- ans: C
19. An erect object is in front of a convex mirror a distance greater than the focal length. The image is:
- A. real, inverted, and smaller than the object
 - B. virtual, inverted, and larger than the object
 - C. real, inverted, and larger than the object
 - D. virtual, erect, and smaller than the object
 - E. real, erect, and larger than the object
- ans: D

20. As an object is moved from the center of curvature of a concave mirror toward its focal point its image:
- A. remains virtual and becomes larger
 - B. remains virtual and becomes smaller
 - C. remains real and becomes larger
 - D. remains real and becomes smaller
 - E. remains real and approaches the same size as the object
- ans: C
21. As an object is moved from a distant location toward the center of curvature of a concave mirror its image:
- A. remains virtual and becomes smaller
 - B. remains virtual and becomes larger
 - C. remains real and becomes smaller
 - D. remains real and becomes larger
 - E. changes from real to virtual
- ans: D
22. The image of an erect candle, formed using a convex mirror, is always:
- A. virtual, inverted, and smaller than the candle
 - B. virtual, inverted, and larger than the candle
 - C. virtual, erect, and larger than the candle
 - D. virtual, erect, and smaller than the candle
 - E. real, erect, and smaller than the candle
- ans: D
23. At what distance in front of a concave mirror must an object be placed so that the image and object are the same size?
- A. a focal length
 - B. half a focal length
 - C. twice a focal length
 - D. less than half focal length
 - E. more than twice a focal length
- ans: B
24. A point source is to be used with a concave mirror to produce a beam of parallel light. The source should be placed:
- A. as close to the mirror as possible
 - B. at the center of curvature
 - C. midway between the center of curvature and the focal point
 - D. midway between the center of curvature and the mirror
 - E. midway between the focal point and the mirror
- ans: D

25. A concave mirror forms a real image that is twice the size of the object. If the object is 20 cm from the mirror, the radius of curvature of the mirror must be about:
- A. 13 cm
 - B. 20 cm
 - C. 27 cm
 - D. 40 cm
 - E. 80 cm
- ans: C

26. A man stands with his nose 8 cm from a concave shaving mirror of radius 32 cm. The distance from the mirror to the image of his nose is:
- A. 8 cm
 - B. 12 cm
 - C. 16 cm
 - D. 24 cm
 - E. 32 cm
- ans: C

27. The figure shows a concave mirror with a small object located at the point marked 6. If the image is also at this point, then the center of curvature of the mirror is at the point marked:

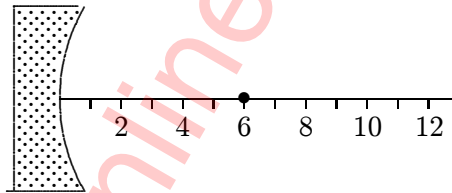

- A. 3
 - B. 4
 - C. 6
 - D. 9
 - E. 12
- ans: C
28. A concave spherical mirror has a focal length of 12 cm. If an object is placed 6 cm in front of it the image position is:
- A. 4 cm behind the mirror
 - B. 4 cm in front of the mirror
 - C. 12 cm behind the mirror
 - D. 12 cm in front of the mirror
 - E. at infinity
- ans: C

29. A concave spherical mirror has a focal length of 12 cm. If an object is placed 18 cm in front of it the image position is:
- A. 7.2 cm behind the mirror
 - B. 7.2 cm in front of the mirror
 - C. 36 cm behind the mirror
 - D. 36 cm in front of the mirror
 - E. at infinity
- ans: D

30. A convex spherical mirror has a focal length of 12 cm. If an object is placed 6 cm in front of it the image position is:
- A. 4 cm behind the mirror
 - B. 4 cm in front of the mirror
 - C. 12 cm behind the mirror
 - D. 12 cm in front of the mirror
 - E. at infinity
- ans: A

31. A concave spherical mirror has a focal length of 12 cm. If an erect object is placed 6 cm in front of it:
- A. the magnification is 2 and the image is erect
 - B. the magnification is 2 and the image is inverted
 - C. the magnification is 0.67 and the image is erect
 - D. the magnification is 0.67 and the image is inverted
 - E. the magnification is 0.5 and the image is erect
- ans: A

32. An erect object is located on the central axis of a spherical mirror. The magnification is -3 . This means:
- A. its image is real, inverted, and on the same side of the mirror
 - B. its image is virtual, erect, and on the opposite side of the mirror
 - C. its image is real, erect, and on the same side of the mirror
 - D. its image is real, inverted, and on the opposite side of the mirror
 - E. its image is virtual, inverted, and on the opposite side of the mirror
- ans: A

33. An object O, in air, is in front of the concave spherical refracting surface of a piece of glass. Which of the general situations depicted below is like this situation?

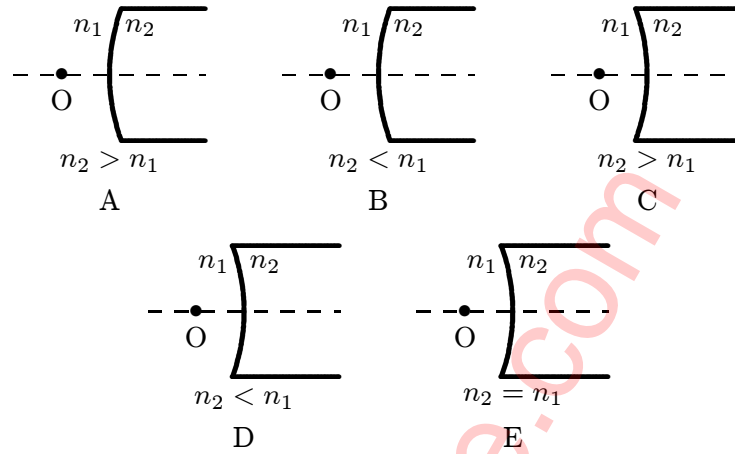

ans: C

34. A concave refracting surface is one with a center of curvature:
- to the left of the surface
 - to the right of the surface
 - on the side of the incident light
 - on the side of the refracted light
 - on the side with the higher index of refraction

ans: C

35. A convex refracting surface has a radius of 12 cm. Light is incident in air ($n = 1$) and is refracted into a medium with an index of refraction of 2. Light incident parallel to the central axis is focused at a point:
- 3 cm from the surface
 - 6 cm from the surface
 - 12 cm from the surface
 - 18 cm from the surface
 - 24 cm from the surface

ans: E

36. A convex refracting surface has a radius of 12 cm. Light is incident in air ($n = 1$) and refracted into a medium with an index of refraction of 2. To obtain light with rays parallel to the central axis after refraction a point source should be placed on the axis:
- 3 cm from the surface
 - 6 cm from the surface
 - 12 cm from the surface
 - 18 cm from the surface
 - 24 cm from the surface

ans: C

37. A concave refracting surface of a medium with index of refraction n produces a real image no matter where an object is placed outside:
- A. always
 - B. only if the index of refraction of the surrounding medium is less than n
 - C. only if the index of refraction of the surrounding medium is greater than n
 - D. never
 - E. none of the above
- ans: E
38. A convex spherical refracting surface separates a medium with index of refraction 2 from air. The image of an object outside the surface is real:
- A. always
 - B. never
 - C. only if it is close to the surface
 - D. only if it is far from the surface
 - E. only if the radius of curvature is small
- ans: D
39. A convex spherical surface with radius r separates a medium with index of refraction 2 from air. As an object is moved toward the surface from far away along the central axis, its image:
- A. changes from virtual to real when it is $r/2$ from the surface
 - B. changes from virtual to real when it is r from the surface
 - C. changes from real to virtual when it is $r/2$ from the surface
 - D. changes from real to virtual when it is r from the surface
 - E. remains real
- ans: D
40. A concave spherical surface with radius r separates a medium with index of refraction 2 from air. As an object is moved toward the surface from far away along the central axis, its image:
- A. changes from virtual to real when it is $r/2$ from the surface
 - B. changes from virtual to real when it is $2r$ from the surface
 - C. changes from real to virtual when it is $r/2$ from the surface
 - D. changes from real to virtual when it is $2r$ from the surface
 - E. remains virtual
- ans: E
41. An erect object is placed on the central axis of a thin lens, further from the lens than the magnitude of its focal length. The magnification is $+0.4$. This means:
- A. the image is real and erect and the lens is a converging lens
 - B. the image is real and inverted and the lens is a converging lens
 - C. the image is virtual and erect, and the lens is a diverging lens
 - D. the image is virtual and erect, and the lens is a converging lens
 - E. the image is virtual and inverted and the lens is a diverging lens
- ans: C

42. Where must an object be placed in front of a converging lens in order to obtain a virtual image?
- A. At the focal point
 - B. At twice the focal length
 - C. Greater than the focal length
 - D. Between the focal point and the lens
 - E. Between the focal length and twice the focal length
- ans: D
43. An erect object placed outside the focal point of a converging lens will produce an image that is:
- A. erect and virtual
 - B. inverted and virtual
 - C. erect and real
 - D. inverted and real
 - E. impossible to locate
- ans: D
44. An object is 30 cm in front of a converging lens of focal length 10 cm. The image is:
- A. real and larger than the object
 - B. real and the same size than the object
 - C. real and smaller than the object
 - D. virtual and the same size than the object
 - E. virtual and smaller than the object
- ans: C
45. Let p denote the object-lens distance and i the image-lens distance. The image produced by a lens of focal length f has a height that can be obtained from the object height by multiplying it by:
- A. p/i
 - B. i/p
 - C. f/p
 - D. f/i
 - E. i/f
- ans: B
46. A camera with a lens of focal length 6.0 cm takes a picture of a 1.4-m tall man standing 11 m away. The height of the image is about:
- A. 0.39 cm
 - B. 0.77 cm
 - C. 1.5 cm
 - D. 3.0 cm
 - E. 6.0 cm
- ans: B

47. A hollow lens is made of thin glass, as shown. It can be filled with air, water ($n = 1.3$) or CS_2 ($n = 1.6$). The lens will diverge a beam of parallel light if it is filled with:

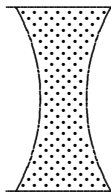

- A. air and immersed in air
B. air and immersed in water
C. water and immersed in CS_2
D. CS_2 and immersed in water
E. CS_2 and immersed in CS_2
ans: D
48. The object-lens distance for a certain converging lens is 400 mm. The image is three times the size of the object. To make the image five times the size of the object-lens distance must be changed to:
A. 360 mm
B. 540 mm
C. 600 mm
D. 720 mm
E. 960 mm
ans: A
49. An erect object is $2f$ in front of a converging lens of focal length f . The image is:
A. real, inverted, magnified
B. real, erect, same size
C. real, inverted, same size
D. virtual, inverted, reduced
E. real, inverted, reduced
ans: C
50. An ordinary magnifying glass in front of an erect object produces an image that is:
A. real and erect
B. real and inverted
C. virtual and inverted
D. virtual and erect
E. none of these
ans: D

51. The Sun subtends 0.5° as seen from Earth. The diameter of its image, using a 1.0-m focal length lens, is about:
- 10 cm
 - 2 cm
 - 1 cm
 - 5 mm
 - 1 mm
- ans: C

52. An object is in front of a converging lens, at a distance less than the focal length from the lens. Its image is:
- virtual and larger than the object
 - real and smaller than the object
 - virtual and smaller than the object
 - real and larger than the object
 - virtual and the same size as the object
- ans: A

53. A plano-convex glass ($n = 1.5$) lens has a curved side whose radius is 50 cm. If the image size is to be the same as the object size, the object should be placed at a distance from the lens of:
- 50 cm
 - 100 cm
 - 200 cm
 - 400 cm
 - 340 cm
- ans: C

54. Which of the following five glass lenses is a diverging lens?

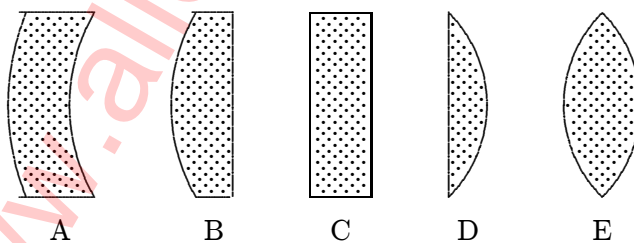

ans: A

55. The bellows of an adjustable camera can be extended so that the largest film to lens distance is one and one-half times the focal length. If the focal length is 12 cm, the nearest object that can be sharply focused on the film must be what distance from the lens?
- 12 cm
 - 24 cm
 - 36 cm
 - 48 cm
 - 72 cm
- ans: C

56. A 3-cm high object is in front of a thin lens. The object distance is 4 cm and the image distance is -8 cm. The image height is:
- A. 0.5 cm
 - B. 1 cm
 - C. 1.5 cm
 - D. 6 cm
 - E. 24 cm
- ans: D
57. When a single-lens camera is focused on a distant object, the lens-to-film distance is found to be 40.0 mm. To focus on an object 0.54 m in front of the lens, the film-to-lens distance should be:
- A. 40.0 mm
 - B. 37.3 mm
 - C. 36.8 mm
 - D. 42.7 mm
 - E. 43.2 mm
- ans: E
58. In a cinema, a picture 2.5 cm wide on the film is projected to an image 3.0 m wide on a screen that is 18 m away. The focal length of the lens is about:
- A. 7.5 cm
 - B. 10 cm
 - C. 12.5 cm
 - D. 15 cm
 - E. 20 cm
- ans: D
59. The term “virtual” as applied to an image made by a mirror means that the image:
- A. is on the mirror surface
 - B. cannot be photographed by a camera
 - C. is in front of the mirror
 - D. is the same size as the object
 - E. cannot be shown directly on a screen
- ans: E
60. Which instrument uses a single converging lens with the object placed just inside the focal point?
- A. Camera
 - B. Compound microscope
 - C. Magnifying glass
 - D. Overhead projector
 - E. Telescope
- ans: C

61. Let f_o and f_e be the focal lengths of the objective and eyepiece of a compound microscope. In ordinary use, the object:
- A. is less than f_o from the objective lens
 - B. is more than f_o from the objective
 - C. produces an intermediate image that is slightly more than f_e from the eyepiece
 - D. produces an intermediate image that is $2f_e$ away from the eyepiece
 - E. produces an intermediate image that is less than f_o from the objective lens
- ans: B
62. Consider the following four statements concerning a compound microscope:
1. Each lens produces an image that is virtual and inverted.
 2. The objective lens has a very short focal length.
 3. The eyepiece is used as a simple magnifying glass.
 4. The objective lens is convex and the eyepiece is concave.
- Which two of the four statements are correct?
- A. 1, 2
 - B. 1, 3
 - C. 1, 4
 - D. 2, 3
 - E. 2, 4
- ans: D
63. What type of eyeglasses should a nearsighted person wear?
- A. diverging lenses
 - B. bifocal lenses
 - C. converging lenses
 - D. plano-convex lenses
 - E. double convex lenses
- ans: A
64. Which of the following is NOT correct for a simple magnifying glass?
- A. The image is virtual
 - B. The image is erect
 - C. The image is larger than the object
 - D. The object is inside the focal point
 - E. The lens is diverging
- ans: E
65. A nearsighted person can see clearly only objects within 1.4 m of her eye. To see distant objects, she should wear eyeglasses of what type and focal length?
- A. diverging, 2.8 m
 - B. diverging, 1.4 m
 - C. converging, 2.8 m
 - D. converging, 1.4 m
 - E. diverging, 0.72 m
- ans: B

66. A magnifying glass has a focal length of 15 cm. If the near point of the eye is 25 cm from the eye the angular magnification of the glass is about:
- A. 0.067
 - B. 0.33
 - C. 0.67
 - D. 1.7
 - E. 15
- ans: D
67. An object is 20 cm to the left of a lens of focal length +10 cm. A second lens, of focal length +12.5 cm, is 30 cm to the right of the first lens. The distance between the original object and the final image is:
- A. 28 cm
 - B. 50 cm
 - C. 100 cm
 - D. 0
 - E. infinity
- ans: D
68. A converging lens of focal length 20 cm is placed in contact with a converging lens of focal length 30 cm. The focal length of this combination is:
- A. +10 cm
 - B. -10 cm
 - C. +60 cm
 - D. -60 cm
 - E. +25 cm
- ans: A
69. A student sets the cross-hairs of an eyepiece in line with an image that he is measuring. He then notes that when he moves his head slightly to the right, the image moves slightly to the left (with respect to the cross-hairs). Therefore the image is:
- A. infinitely far away
 - B. farther away from him than the cross-hairs
 - C. nearer to him than the cross-hairs
 - D. in the focal plane of the eyepiece
 - E. in the plane of the cross-hairs
- ans: C
70. In a two lens microscope, the intermediate image is:
- A. virtual, erect, and magnified
 - B. real, erect, and magnified
 - C. real, inverted, and magnified
 - D. virtual, inverted, and reduced
 - E. virtual, inverted, and magnified
- ans: C

71. Two thin lenses (focal lengths f_1 and f_2) are in contact. Their equivalent focal length is:
- $f_1 + f_2$
 - $f_1 f_2 / (f_1 + f_2)$
 - $1/f_1 + 1/f_2$
 - $f_1 - f_2$
 - $f_1(f_1 - f_2) / f_2$

ans: B

72. The two lenses shown are illuminated by a beam of parallel light from the left. Lens B is then moved slowly toward lens A. The beam emerging from lens B is:

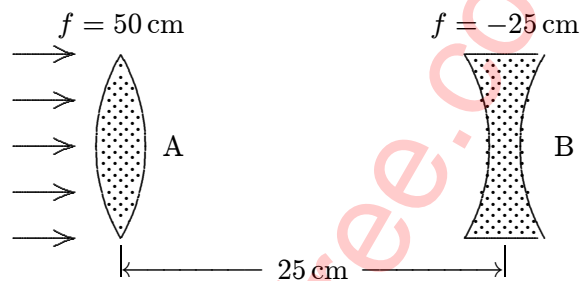

- initially parallel and then diverging
- always diverging
- initially converging and finally parallel
- always parallel
- initially converging and finally diverging

ans: A

Chapter 35: INTERFERENCE

1. A “wave front” is a surface of constant:
 - A. phase
 - B. frequency
 - C. wavelength
 - D. amplitude
 - E. speedans: A
2. Huygens’ construction can be used only:
 - A. for light
 - B. for an electromagnetic wave
 - C. if one of the media is vacuum (or air)
 - D. for transverse waves
 - E. for all of the above and other situationsans: E
3. Consider (I) the law of reflection and (II) the law of refraction. Huygens’ principle can be used to derive:
 - A. only I
 - B. only II
 - C. both I and II
 - D. neither I nor II
 - E. the question is meaningless because Huygens’ principle is for wave fronts whereas both I and II concern raysans: C
4. Units of “optical path length” are:
 - A. m^{-1}
 - B. m
 - C. m/s
 - D. Hz/m
 - E. m/Hzans: B

5. The light waves represented by the three rays shown in the diagram all have the same frequency. 4.7 wavelengths fit into layer 1, 3.2 wavelengths fit into layer 2, and 5.3 wavelengths fit into layer 3. Rank the layers according to the speeds of the waves, least to greatest.

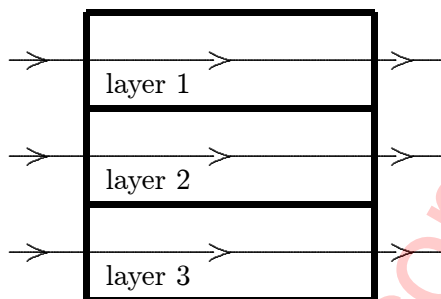

- A. 1, 2, 3
 B. 2, 1, 3
 C. 3, 1, 2
 D. 3, 1, 2
 E. 1, 3, 2
 ans: D
6. Interference of light is evidence that:
 A. the speed of light is very large
 B. light is a transverse wave
 C. light is electromagnetic in character
 D. light is a wave phenomenon
 E. light does not obey conservation of energy
 ans: D
7. The reason there are two slits, rather than one, in a Young's experiment is:
 A. to increase the intensity
 B. one slit is for frequency, the other for wavelength
 C. to create a path length difference
 D. one slit is for \vec{E} fields, the other is for \vec{B} fields
 E. two slits in parallel offer less resistance
 ans: C
8. In a Young's double-slit experiment the center of a bright fringe occurs wherever waves from the slits differ in the distance they travel by a multiple of:
 A. a fourth of a wavelength
 B. a half a wavelength
 C. a wavelength
 D. three-fourths of a wavelength
 E. none of the above
 ans: E

9. In a Young's double-slit experiment the center of a bright fringe occurs wherever waves from the slits differ in phase by a multiple of:
- A. $\pi/4$
 - B. $\pi/2$
 - C. π
 - D. $3\pi/4$
 - E. 2π

ans: E

10. Waves from two slits are in phase at the slits and travel to a distant screen to produce the third side maximum of the interference pattern. The difference in the distance traveled by the waves is:
- A. half a wavelength
 - B. a wavelength
 - C. three halves of a wavelength
 - D. two wavelengths
 - E. three wavelengths

ans: E

11. Waves from two slits are in phase at the slits and travel to a distant screen to produce the second minimum of the interference pattern. The difference in the distance traveled by the waves is:
- A. half a wavelength
 - B. a wavelength
 - C. three halves of a wavelength
 - D. two wavelengths
 - E. five halves of a wavelength

ans: C

12. A monochromatic light source illuminates a double slit and the resulting interference pattern is observed on a distant screen. Let d = center-to-center slit spacing, a = individual slit width, D = screen-to-slit distance, and ℓ = adjacent dark line spacing in the interference pattern. The wavelength of the light is then:

- A. $d\ell/D$
- B. Ld/a
- C. da/D
- D. $\ell D/a$
- E. Dd/ℓ

ans: A

13. Light from a small region of an ordinary incandescent bulb is passed through a yellow filter and then serves as the source for a Young's double-slit experiment. Which of the following changes would cause the interference pattern to be more closely spaced?
- A. Use slits that are closer together
 - B. Use a light source of lower intensity
 - C. Use a light source of higher intensity
 - D. Use a blue filter instead of a yellow filter
 - E. Move the light source further away from the slits.

ans: D

14. In a Young's double-slit experiment, the slit separation is doubled. To maintain the same fringe spacing on the screen, the screen-to-slit distance D must be changed to:
- A. $D/2$
 - B. $D/\sqrt{2}$
 - C. $D\sqrt{2}$
 - D. $2D$
 - E. $4D$

ans: D

15. In a Young's double-slit experiment, light of wavelength 500 nm illuminates two slits that are separated by 1 mm. The separation between adjacent bright fringes on a screen 5 m from the slits is:
- A. 0.10 cm
 - B. 0.25 cm
 - C. 0.50 cm
 - D. 1.0 cm
 - E. none of the above

ans: B

16. In a Young's double-slit experiment, the separation between slits is d and the screen is a distance D from the slits. D is much greater than d and λ is the wavelength of the light. The number of bright fringes per unit width on the screen is:
- A. Dd/λ
 - B. $D\lambda/d$
 - C. $D/d\lambda$
 - D. λ/Dd
 - E. $d/D\lambda$

ans: E

17. In a Young's double-slit experiment, the slit separation is doubled. This results in:
- A. an increase in fringe intensity
 - B. a decrease in fringe intensity
 - C. a halving of the wavelength
 - D. a halving of the fringe spacing
 - E. a doubling of the fringe spacing

ans: D

18. In an experiment to measure the wavelength of light using a double slit, it is found that the fringes are too close together to easily count them. To spread out the fringe pattern, one could:
- A. decrease the slit separation
 - B. increase the slit separation
 - C. increase the width of each slit
 - D. decrease the width of each slit
 - E. none of these

ans: A

19. The phase difference between the two waves that give rise to a dark spot in a Young's double-slit experiment is (where $m = \text{integer}$):
- A. zero
 - B. $2\pi m + \pi/8$
 - C. $2\pi m + \pi/4$
 - D. $2\pi m + \pi/2$
 - E. $2\pi m + \pi$

ans: E

20. In a Young's experiment, it is essential that the two beams:

- A. have exactly equal intensity
- B. be exactly parallel
- C. travel equal distances
- D. come originally from the same source
- E. be composed of a broad band of frequencies

ans: D

21. A light wave with an electric field amplitude of E_0 and a phase constant of zero is to be combined with one of the following waves:

- wave A has an amplitude of E_0 and a phase constant of zero
- wave B has an amplitude of E_0 and a phase constant of π
- wave C has an amplitude of $2E_0$ and a phase constant of zero
- wave D has an amplitude of $2E_0$ and a phase constant of π
- wave E has an amplitude of $3E_0$ and a phase constant of π

Which of these combinations produces the greatest intensity?

ans: C

22. A light wave with an electric field amplitude of $2E_0$ and a phase constant of zero is to be combined with one of the following waves:

- wave A has an amplitude of E_0 and a phase constant of zero
- wave B has an amplitude of E_0 and a phase constant of π
- wave C has an amplitude of $2E_0$ and a phase constant of zero
- wave D has an amplitude of $2E_0$ and a phase constant of π
- wave E has an amplitude of $3E_0$ and a phase constant of π

Which of these combinations produces the least intensity?

ans: D

23. One of the two slits in a Young's experiment is painted over so that it transmits only one-half the intensity of the other slit. As a result:
- the fringe system disappears
 - the bright fringes get brighter and the dark ones get darker
 - the fringes just get dimmer
 - the dark fringes just get brighter
 - the dark fringes get brighter and the bright ones get darker
- ans: E

24. In a Young's double-slit experiment, a thin sheet of mica is placed over one of the two slits. As a result, the center of the fringe pattern (on the screen) shifts by an amount corresponding to 30 dark bands. The wavelength of the light in this experiment is 480 nm and the index of the mica is 1.60. The mica thickness is:
- 0.090 mm
 - 0.012 mm
 - 0.014 mm
 - 0.024 mm
 - 0.062 mm
- ans: D

25. Light from a point source X contains only blue and red components. After passing through a mysterious box, the light falls on a screen. Bright red and blue bands are observed as shown. The box must contain:

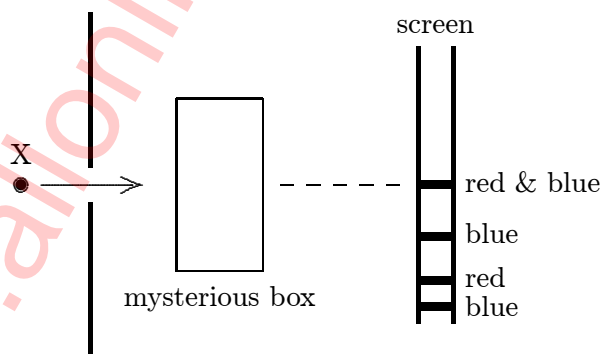

- a lens
 - a mirror
 - a prism
 - a double slit
 - a blue and red filter
- ans: D

26. Binoculars and microscopes are frequently made with coated optics by adding a thin layer of transparent material to the lens surface as shown. One wants:

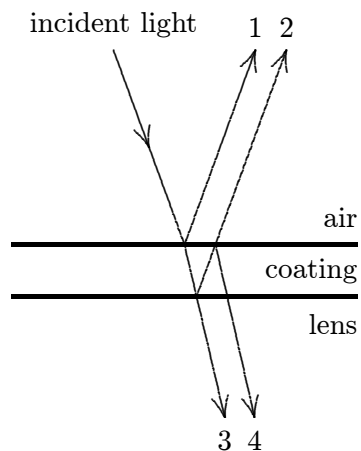

- A. constructive interference between waves 1 and 2
 B. destructive interference between waves 3 and 4
 C. constructive interference between 3 and 4
 D. the coating to be more transparent than the lens
 E. the speed of light in the coating to be less than that in the lens
 ans: C
27. Monochromatic light, at normal incidence, strikes a thin film in air. If λ denotes the wavelength in the film, what is the thinnest film in which the reflected light will be a maximum?
 A. Much less than λ
 B. $\lambda/4$
 C. $\lambda/2$
 D. $3\lambda/4$
 E. λ
 ans: B
28. A soap film is illuminated by white light normal to its surface. The index of refraction of the film is 1.50. Wavelengths of 480 nm and 800 nm and no wavelengths between are intensified in the reflected beam. The thickness of the film is:
 A. 1.5×10^{-5} cm
 B. 2.4×10^{-5} cm
 C. 3.6×10^{-5} cm
 D. 4.0×10^{-5} cm
 E. 6.0×10^{-5} cm
 ans: D

29. Red light is viewed through a thin vertical soap film. At the third dark area shown, the thickness of the film, in terms of the wavelength within the film, is:

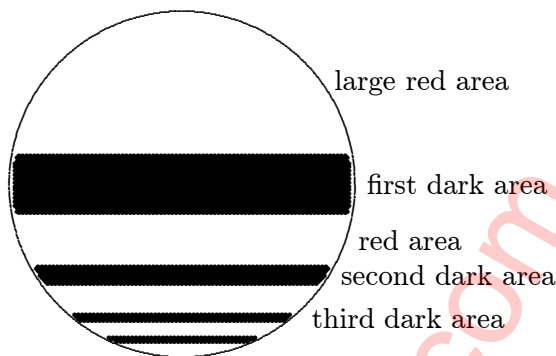

- A. λ
- B. $3\lambda/4$
- C. $\lambda/2$
- D. $\lambda/4$
- E. $5\lambda/4$

ans: E

30. Yellow light is viewed by reflection from a thin vertical soap film. Let λ be the wavelength of the light within the film. Why is there a large dark space at the top of the film?



- A. no light is transmitted through this part of the film
- B. the film thickness there is $\lambda/4$
- C. the film thickness there is much less than λ
- D. the film is too thick in this region for thin film formulas to apply
- E. the reflected light is in the infrared

ans: C

31. Three experiments involving a thin film (in air) are shown. If t denotes the film thickness and λ denotes the wavelength of the light in the film, which experiments will produce constructive interference as seen by the observer? The incident light is nearly normal to the surface.

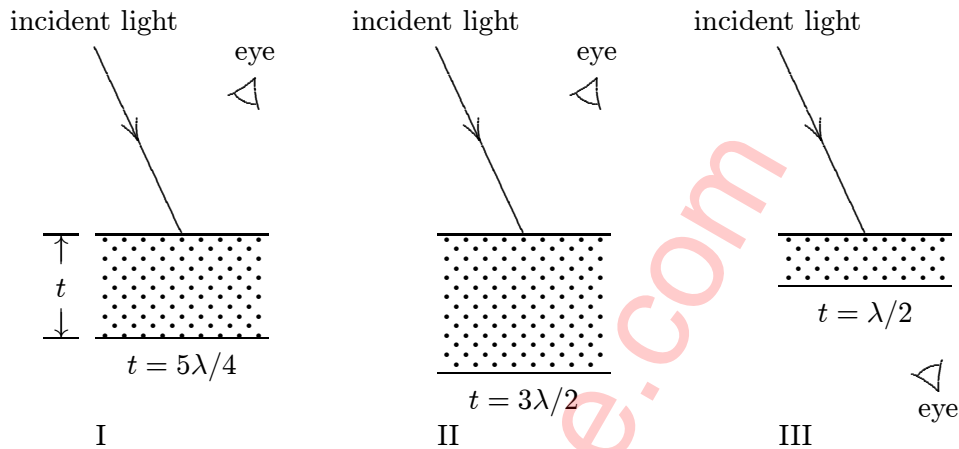

- A. I only
 B. II only
 C. III only
 D. I and III only
 E. II and III only

ans: D

32. A liquid of refractive index $n = 4/3$ replaces the air between a fixed wedge formed from two glass plates as shown. As a result, the spacing between adjacent dark bands in the interference pattern:

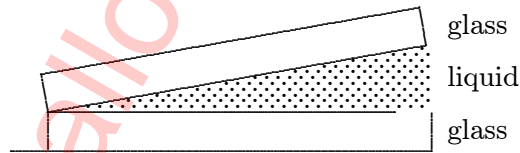

- A. increases by a factor of $4/3$
 B. increases by a factor of 3
 C. remains the same
 D. decreases to $3/4$ of its original value
 E. decreases to $1/3$ of its original value

ans: D

33. A lens with a refractive index of 1.5 is coated with a material of refractive index 1.2 in order to minimize reflection. If λ denotes the wavelength of the incident light in air, what is the thinnest possible such coating?

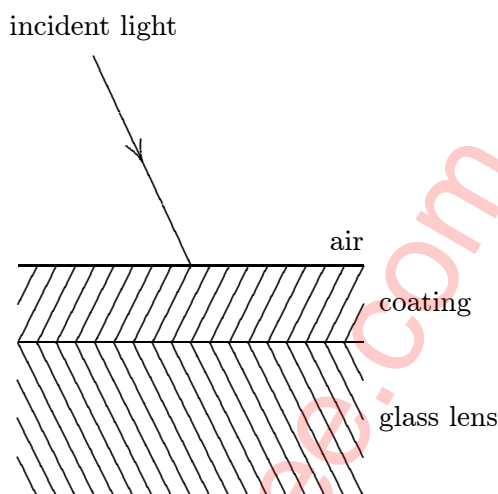

- A. 0.5λ
 B. 0.416λ
 C. 0.3λ
 D. 0.208λ
 E. 0.25λ
 ans: D
34. In a thin film experiment, a wedge of air is used between two glass plates. If the wavelength of the incident light in air is 480 nm, how much thicker is the air wedge at the 16th dark fringe than it is at the 6th?
- A. 2400 nm
 B. 4800 nm
 C. 240 nm
 D. 480 nm
 E. None of these
 ans: A
35. An air wedge is formed from two glass plates that are in contact at their left edges. There are ten dark bands when viewed by reflection using monochromatic light. The left edge of the top plate is now slowly lifted until the plates are parallel. During this process:
- A. the dark bands crowd toward the right edge
 B. the dark bands remain stationary
 C. the dark bands crowd toward the left edge
 D. the dark bands spread out, disappearing off the right edge
 E. the dark bands spread out, disappearing off the left edge
 ans: E

36. An air wedge is formed using two glass plates that are in contact along their left edge. When viewed by highly monochromatic light, there are exactly 4001 dark bands in the reflected light. The air is now evacuated (with the glass plates remaining rigidly fixed) and the number of dark bands decreases to exactly 4000. The index of refraction of the air is:
- A. 0.00025
 - B. 0.00050
 - C. 1.00025
 - D. 1.00050
 - E. 1.00000, by definition
- ans: C
37. A glass ($n = 1.6$) lens is coated with a thin film ($n = 1.3$) to reduce reflection of certain incident light. If λ is the wavelength of the light in the film, the least film thickness is:
- A. less than $\lambda/4$
 - B. $\lambda/4$
 - C. $\lambda/2$
 - D. λ
 - E. more than λ
- ans: B
38. Two point sources, vibrating in phase, produce an interference pattern in a ripple tank. If the frequency is increased by 20%, the number of nodal lines:
- A. is increased by 20%
 - B. is increased by 40%
 - C. remains the same
 - D. is decreased by 20%
 - E. is decreased by 40%
- ans: A
39. If two light waves are coherent:
- A. their amplitudes are the same
 - B. their frequencies are the same
 - C. their wavelengths are the same
 - D. their phase difference is constant
 - E. the difference in their frequencies is constant
- ans: D
40. To obtain an observable double-slit interference pattern:
- A. the light must be incident normally on the slits
 - B. the light must be monochromatic
 - C. the light must consist of plane waves
 - D. the light must be coherent
 - E. the screen must be far away from the slits
- ans: D

Chapter 36: DIFFRACTION

1. Sound differs from light in that sound:
 - A. is not subject to diffraction
 - B. is a torsional wave rather than a longitudinal wave
 - C. does not require energy for its origin
 - D. is a longitudinal wave rather than a transverse wave
 - E. is always monochromaticans: D
2. Radio waves are readily diffracted around buildings whereas light waves are negligibly diffracted around buildings. This is because radio waves:
 - A. are plane polarized
 - B. have much longer wavelengths than light waves
 - C. have much shorter wavelengths than light waves
 - D. are nearly monochromatic (single frequency)
 - E. are amplitude modulated (AM).ans: B
3. Diffraction plays an important role in which of the following phenomena?
 - A. The sun appears as a disk rather than a point to the naked eye
 - B. Light is bent as it passes through a glass prism
 - C. A cheerleader yells through a megaphone
 - D. A farsighted person uses eyeglasses of positive focal length
 - E. A thin soap film exhibits colors when illuminated with white lightans: C
4. The rainbow seen after a rain shower is caused by:
 - A. diffraction
 - B. interference
 - C. refraction
 - D. polarization
 - E. absorptionans: C
5. When a highly coherent beam of light is directed against a very fine wire, the shadow formed behind it is not just that of a single wire but rather looks like the shadow of several parallel wires. The explanation of this involves:
 - A. refraction
 - B. diffraction
 - C. reflection
 - D. the Doppler effect
 - E. an optical illusionans: B

6. When the atmosphere is not quite clear, one may sometimes see colored circles concentric with the Sun or the Moon. These are generally not more than a few diameters of the Sun or Moon and invariably the innermost ring is blue. The explanation for this phenomena involves:
- A. reflection
 - B. refraction
 - C. interference
 - D. diffraction
 - E. the Doppler effect

ans: D

7. The shimmering or wavy lines that can often be seen near the ground on a hot day are due to:
- A. Brownian movement
 - B. reflection
 - C. refraction
 - D. diffraction
 - E. dispersion

ans: C

8. A point source of monochromatic light is placed in front of a soccer ball and a screen is placed behind the ball. The light intensity pattern on the screen is best described as:
- A. a dark disk on a bright background
 - B. a dark disk with bright rings outside
 - C. a dark disk with a bright spot at its center
 - D. a dark disk with a bright spot at its center and bright rings outside
 - E. a bright disk with bright rings outside

ans: D

9. In the equation $\sin \theta = \lambda/a$ for single-slit diffraction, θ is:
- A. the angle to the first minimum
 - B. the angle to the second maximum
 - C. the phase angle between the extreme rays
 - D. $N\pi$ where N is an integer
 - E. $(N + 1/2)\pi$ where N is an integer

ans: A

10. In the equation $\phi = (2\pi a/\lambda) \sin \theta$ for single-slit diffraction, ϕ is:
- A. the angle to the first minimum
 - B. the angle to the second maximum
 - C. the phase angle between the extreme rays
 - D. $N\pi$ where N is an integer
 - E. $(N + 1/2)\pi$ where N is an integer

ans: C

11. No fringes are seen in a single-slit diffraction pattern if:
- the screen is far away
 - the wavelength is less than the slit width
 - the wavelength is greater than the slit width
 - the wavelength is less than the distance to the screen
 - the distance to the screen is greater than the slit width

ans: C

12. A student wishes to produce a single-slit diffraction pattern in a ripple tank experiment. He considers the following parameters:
- frequency
 - wavelength
 - water depth
 - slit width

Which two of the above should be decreased to produce more bending?

- 1, 3
- 1, 4
- 2, 3
- 2, 4
- 3, 4

ans: B

13. A parallel beam of monochromatic light is incident on a slit of width 2 cm. The light passing through the slit falls on a screen 2 m away. As the slit width is decreased:
- the width of the pattern on the screen continuously decreases
 - the width of the pattern on the screen at first decreases but then increases
 - the width of the pattern on the screen increases and then decreases
 - the width of the pattern on the screen remains the same
 - the pattern on the screen changes color going from red to blue

ans: B

14. Monochromatic plane waves of light are incident normally on a single slit. Which one of the five figures below correctly shows the diffraction pattern observed on a distant screen?

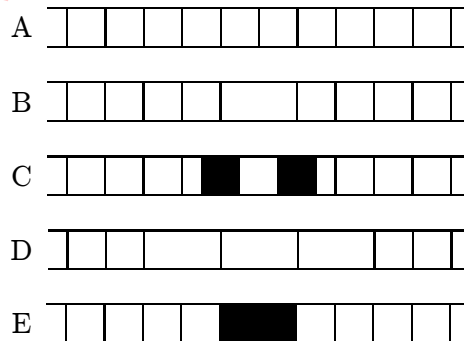

ans: B

15. The diagram shows a single slit with the direction to a point P on a distant screen shown. At P, the pattern has its second minimum (from its central maximum). If X and Y are the edges of the slit, what is the path length difference (PX) - (PY)?

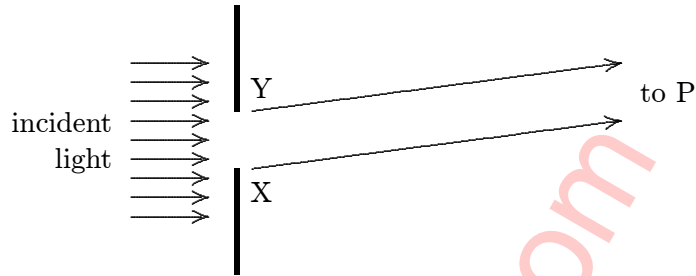

- A. $\lambda/2$
- B. λ
- C. $3\lambda/2$
- D. 2λ
- E. $5\lambda/2$

ans: D

16. The diagram shows a single slit with the direction to a point P on a distant screen shown. At P, the pattern has its maximum nearest the central maximum. If X and Y are the edges of the slit, what is the path length difference (PX) - (PY)?

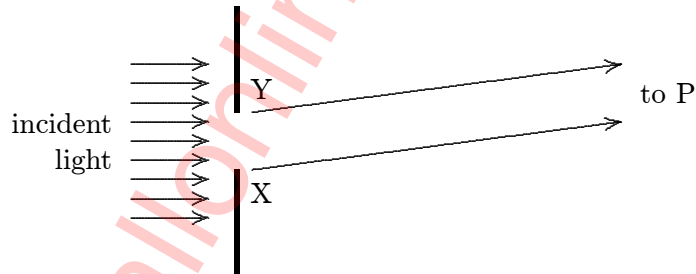

- A. $\lambda/2$
- B. λ
- C. $3\lambda/2$
- D. 2λ
- E. $5\lambda/2$

ans: C

17. At the first minimum adjacent to the central maximum of a single-slit diffraction pattern the phase difference between the Huygens wavelet from the top of the slit and the wavelet from the midpoint of the slit is:

- A. $\pi/8$ rad
- B. $\pi/4$ rad
- C. $\pi/2$ rad
- D. π rad
- E. $3\pi/2$ rad

ans: D

18. At the second minimum adjacent to the central maximum of a single-slit diffraction pattern the Huygens wavelet from the top of the slit is 180° out of phase with the wavelet from:
- A. a point one-fourth of the slit width from the top
 - B. the midpoint of the slit
 - C. a point one-fourth of the slit width from the bottom of the slit
 - D. the bottom of the slit
 - E. none of these
- ans: A
19. A plane wave with a wavelength of 500 nm is incident normally on a single slit with a width of 5.0×10^{-6} m. Consider waves that reach a point on a far-away screen such that rays from the slit make an angle of 1.0° with the normal. The difference in phase for waves from the top and bottom of the slit is:
- A. 0
 - B. 0.55 rad
 - C. 1.1 rad
 - D. 1.6 rad
 - E. 2.2 rad
- ans: C
20. A diffraction pattern is produced on a viewing screen by illuminating a long narrow slit with light of wavelength λ . If λ is increased and no other changes are made:
- A. the intensity at the center of the pattern decreases and the pattern expands away from the bright center
 - B. the intensity at the center of the pattern increases and the pattern contracts toward the bright center
 - C. the intensity at the center of the pattern does not change and the pattern expands away from the bright center
 - D. the intensity at the center of the pattern does not change and the pattern contracts toward the bright center
 - E. neither the intensity at the center of the pattern nor the pattern itself change
- ans: C
21. A diffraction pattern is produced on a viewing screen by illuminating a long narrow slit with light of wavelength λ . If the slit width is decreased and no other changes are made:
- A. the intensity at the center of the pattern decreases and the pattern expands away from the bright center
 - B. the intensity at the center of the pattern increases and the pattern contracts toward the bright center
 - C. the intensity at the center of the pattern does not change and the pattern expands away from the bright center
 - D. the intensity at the center of the pattern does not change and the pattern contracts toward the bright center
 - E. neither the intensity at the center of the pattern nor the pattern itself change
- ans: A

22. In order to obtain a good single-slit diffraction pattern, the slit width could be:
- A. λ
 - B. $\lambda/10$
 - C. 10λ
 - D. $10^4\lambda$
 - E. $\lambda/10^4$
- ans: C
23. Consider a single-slit diffraction pattern caused by a slit of width a . There is a maximum if $\sin\theta$ is equal to:
- A. slightly more than $3\lambda/2a$
 - B. slightly less than $3\lambda/2a$
 - C. exactly $3\lambda/2a$
 - D. exactly $\lambda/2a$
 - E. very nearly $\lambda/2a$
- ans: B
24. Consider a single-slit diffraction pattern caused by a slit of width a . There is a minimum if $\sin\theta$ is equal to:
- A. exactly λ/a
 - B. slightly more than λ/a
 - C. slightly less than λ/a
 - D. exactly $\lambda/2a$
 - E. very nearly $\lambda/2a$
- ans: A
25. In a single-slit diffraction pattern, the central maximum is about twice as wide as the other maxima. This is because:
- A. half the light is diffracted up and half is diffracted down
 - B. the central maximum has both electric and magnetic fields present
 - C. the small angle approximation applies only near the central maximum
 - D. the screen is flat instead of spherical
 - E. none of the above
- ans: E
26. The intensity at a secondary maximum of a single-slit diffraction pattern is less than the intensity at the central maximum chiefly because:
- A. some Huygens wavelets sum to zero at the secondary maximum but not at the central maximum
 - B. the secondary maximum is further from the slits than the central maximum and intensity decreases as the square of the distance
 - C. the Huygens construction is not valid for a secondary maximum
 - D. the amplitude of every Huygens wavelet is smaller when it travels to a secondary maximum than when it travels to the central maximum
 - E. none of the above
- ans: A

27. Figure (i) shows a double-slit pattern obtained using monochromatic light. Consider the following five possible changes in conditions:

1. decrease the frequency
2. increase the frequency
3. increase the width of each slit
4. increase the separation between the slits
5. decrease the separation between the slits

Which of the above would change Figure (i) into Figure (ii)?

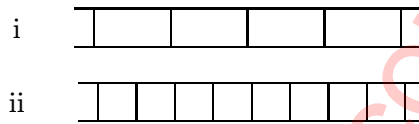

- A. 3 only
- B. 5 only
- C. 1 and 3 only
- D. 1 and 5 only
- E. 2 and 4 only

ans: E

28. Two wavelengths, 800 nm and 600 nm, are used separately in single-slit diffraction experiments. The diagram shows the intensities on a far-away viewing screen as function of the angle made by the rays with the straight-ahead direction. If both wavelengths are then used simultaneously, at which angle is the light on the screen purely 800-nm light?

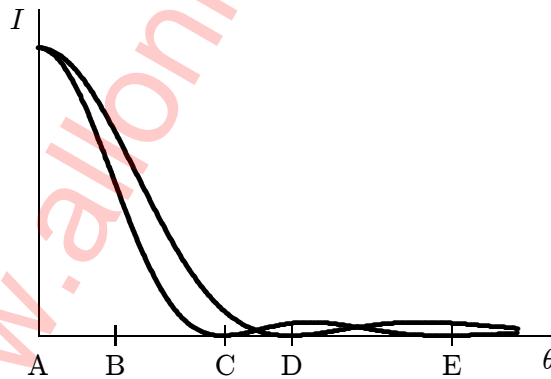

ans: C

29. If we increase the wavelength of the light used to form a double-slit diffraction pattern:
- A. the width of the central diffraction peak increases and the number of bright fringes within the peak increases
 - B. the width of the central diffraction peak increases and the number of bright fringes within the peak decreases
 - C. the width of the central diffraction peak decreases and the number of bright fringes within the peak increases
 - D. the width of the central diffraction peak decreases and the number of bright fringes within the peak decreases
 - E. the width of the central diffraction peak increases and the number of bright fringes within the peak stays the same
- ans: E
30. Two slits of width a and separation d are illuminated by a beam of light of wavelength λ . The separation of the interference fringes on a screen a distance D away is:
- A. $\lambda a/D$
 - B. $\lambda d/D$
 - C. $\lambda D/d$
 - D. dD/λ
 - E. $\lambda D/a$
- ans: C
31. Two slits in an opaque barrier each have a width of 0.020 mm and are separated by 0.050 mm. When coherent monochromatic light passes through the slits the number of interference maxima within the central diffraction maximum:
- A. is 1
 - B. is 2
 - C. is 4
 - D. is 5
 - E. cannot be determined unless the wavelength is given
- ans: D
32. When 450-nm light is incident normally on a certain double-slit system the number of interference maxima within the central diffraction maximum is 5. When 900-nm light is incident on the same slit system the number is:
- A. 2
 - B. 3
 - C. 5
 - D. 9
 - E. 10
- ans: C

33. In a double-slit diffraction experiment the number of interference fringes within the central diffraction maximum can be increased by:
- A. increasing the wavelength
 - B. decreasing the wavelength
 - C. decreasing the slit separation
 - D. increasing the slit width
 - E. decreasing the slit width
- ans: E
34. A diffraction-limited laser of length ℓ and aperture diameter d generates light of wavelength λ . If the beam is directed at the surface of the Moon a distance D away, the radius of the illuminated area on the Moon is approximately:
- A. dD/ℓ
 - B. dD/λ
 - C. $D\lambda/\ell$
 - D. $D\lambda/d$
 - E. $\ell\lambda/d$
- ans: D
35. Two stars that are close together are photographed through a telescope. The black and white film is equally sensitive to all colors. Which situation would result in the most clearly separated images of the stars?
- A. Small lens, red stars
 - B. Small lens, blue stars
 - C. Large lens, red stars
 - D. Large lens, blue stars
 - E. Large lens, one star red and the other blue
- ans: D
36. The resolving power of a telescope can be increased by:
- A. increasing the objective focal length and decreasing the eyepiece focal length
 - B. increasing the lens diameters
 - C. decreasing the lens diameters
 - D. inserting a correction lens between objective and eyepiece
 - E. none of the above
- ans: B
37. In the equation $d \sin \theta = m\lambda$ for the lines of a diffraction grating m is:
- A. the number of slits
 - B. the slit width
 - C. the slit separation
 - D. the order of the line
 - E. the index of refraction
- ans: D

38. In the equation $d \sin \theta = m\lambda$ for the lines of a diffraction grating d is:
- A. the number of slits
 - B. the slit width
 - C. the slit separation
 - D. the order of the line
 - E. the index of refraction
- ans: C
39. As more slits with the same spacing are added to a diffraction grating the lines:
- A. spread farther apart
 - B. move closer together
 - C. become wider
 - D. becomes narrower
 - E. do not change in position or width
- ans: D
40. An N -slit system has slit separation d and slit width a . Plane waves with intensity I and wavelength λ are incident normally on it. The angular separation of the lines depends only on:
- A. a and N
 - B. a and λ
 - C. N and λ
 - D. d and λ
 - E. I and N
- ans: D
41. 600-nm light is incident on a diffraction grating with a ruling separation of 1.7×10^{-6} m. The second order line occurs at a diffraction angle of:
- A. 0
 - B. 10°
 - C. 21°
 - D. 42°
 - E. 45°
- ans: E
42. The widths of the lines produced by monochromatic light falling on a diffraction grating can be reduced by:
- A. increasing the wavelength of the light
 - B. increasing the number of rulings without changing their spacing
 - C. decreasing the spacing between adjacent rulings without changing the number of rulings
 - D. decreasing both the wavelength and the spacing between rulings by the same factor
 - E. increasing the number of rulings and decreasing their spacing so the length of the grating remains the same
- ans: B

43. Monochromatic light is normally incident on a diffraction grating that is 1 cm wide and has 10,000 slits. The first order line is deviated at a 30° angle. What is the wavelength, in nm, of the incident light?
- A. 300
 - B. 400
 - C. 500
 - D. 600
 - E. 1000
- ans: C
44. A light spectrum is formed on a screen using a diffraction grating. The entire apparatus (source, grating and screen) is now immersed in a liquid of refractive index 1.33. As a result, the pattern on the screen:
- A. remains the same
 - B. spreads out
 - C. crowds together
 - D. becomes reversed, with the previously blue end becoming red
 - E. disappears because the refractive index isn't an integer
- ans: C
45. The spacing between adjacent slits on a diffraction grating is 3λ . The deviation θ of the first order diffracted beam is given by:
- A. $\sin(\theta/2) = 1/3$
 - B. $\sin(\theta/3) = 2/3$
 - C. $\sin(\theta) = 1/3$
 - D. $\tan(\theta/2) = 1/3$
 - E. $\tan(\theta) = 2/3$
- ans: C
46. When light of a certain wavelength is incident normally on a certain diffraction grating the line of order 1 is at a diffraction angle of 25° . The diffraction angle for the second order line is:
- A. 25°
 - B. 42°
 - C. 50°
 - D. 58°
 - E. 75°
- ans D
47. A diffraction grating of width W produces a deviation θ in second order for light of wavelength λ . The total number N of slits in the grating is given by:
- A. $2W\lambda/\sin\theta$
 - B. $(W/\lambda)\sin\theta$
 - C. $\lambda W/2\sin\theta$
 - D. $(W/2\lambda)\sin\theta$
 - E. $2\lambda/\sin\theta$
- ans: D

48. Light of wavelength λ is normally incident on a diffraction grating G. On the screen S, the central line is at P and the first order line is at Q, as shown. The distance between adjacent slits in the grating is:

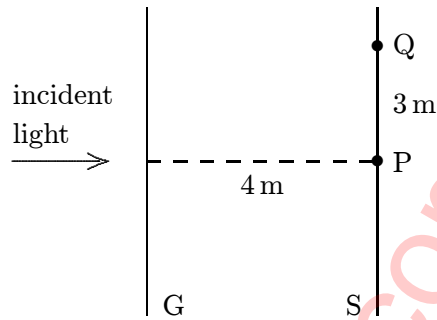

- A. $3\lambda/5$
 B. $3\lambda/4$
 C. $4\lambda/5$
 D. $5\lambda/4$
 E. $5\lambda/3$
 ans: E
49. 550-nm light is incident normally on a diffraction grating and exactly 6 lines are produced. The ruling separation must be:
- A. between 2.75×10^{-7} m and 5.50×10^{-7} m
 B. between 5.50×10^{-7} m and 1.10×10^{-6} m
 C. between 3.30×10^{-6} m and 3.85×10^{-6} m
 D. between 3.85×10^{-6} m and 4.40×10^{-6} m
 E. greater than 4.40×10^{-6} m
 ans: E
50. A mixture of 450-nm and 900-nm light is incident on a diffraction grating. Which of the following is true?
- A. all lines of the 900-nm light coincide with even order lines of the 450-nm light
 B. all lines of the 450-nm light coincide with even order lines of the 900-nm light
 C. all lines of the 900-nm light coincide with odd order lines of the 450-nm light
 D. None of the lines of the 450-nm light coincide with lines of the 900-nm light
 E. All of the lines of the 450-nm light coincide with lines of the 900-nm light
 ans: A

51. A beam of white light (from 400 nm for violet to 700 nm for red) is normally incident on a diffraction grating. It produces two orders on a distant screen. Which diagram below (R = red, V = violet) correctly shows the pattern on the screen?

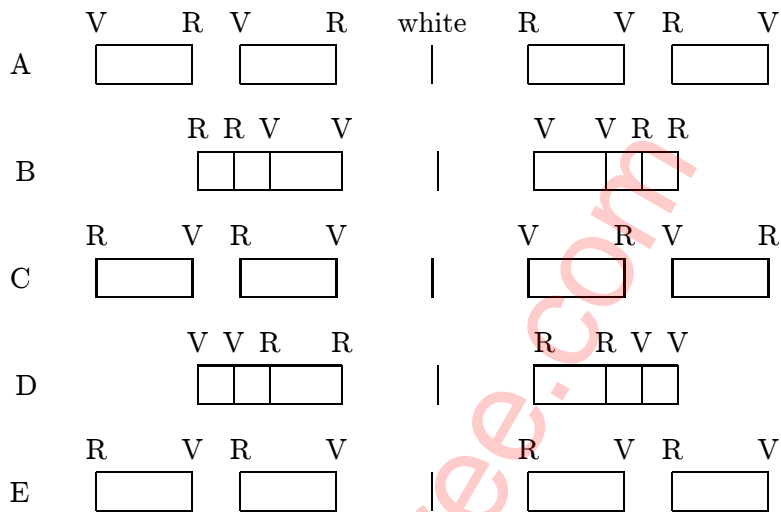

ans: C

52. If white light is incident on a diffraction grating:
- the first order lines for all visible wavelengths occur at smaller diffraction angles than any of the second order lines
 - some first order lines overlap the second order lines if the ruling separation is small but do not if it is large
 - some first order lines overlap second order lines if the ruling separation is large but do not if it is small
 - some first order lines overlap second order lines no matter what the ruling separation
 - first and second order lines have the same range of diffraction angles

ans: A

53. Light of wavelength λ is normally incident on some plane optical device. The intensity pattern shown is observed on a distant screen (θ is the angle measured from the normal of the device). The device could be:

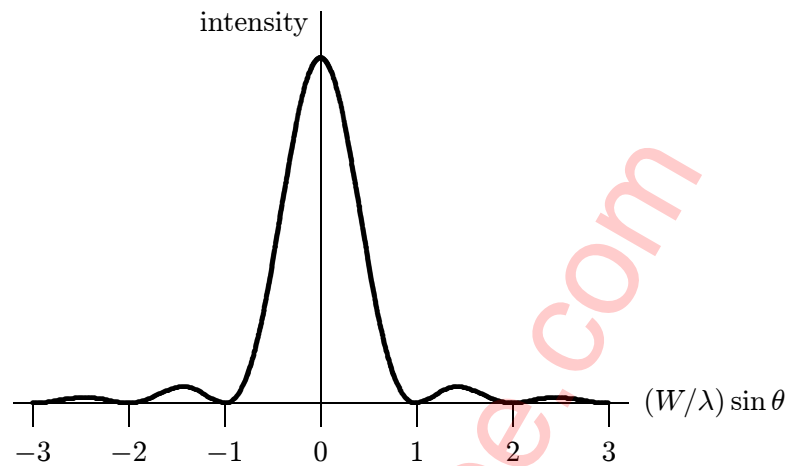

- A. a single slit of width W
 B. a single slit of width $2W$
 C. two narrow slits with separation W
 D. two narrow slits with separation $2W$
 E. a diffraction grating with slit separation W
 ans: A
54. A person with her eye relaxed looks through a diffraction grating at a distant monochromatic point source of light. The slits of the grating are vertical. She sees:
 A. one point of light
 B. a hazy horizontal strip of light of the same color as the source
 C. a hazy strip of light varying from violet to red
 D. a sequence of horizontal points of light
 E. a sequence of closely spaced vertical lines
 ans: D
55. Monochromatic light is normally incident on a diffraction grating. The m^{th} order line is at a diffraction angle θ and has width w . A wide single slit is now placed in front of the grating and its width is then slowly reduced. As a result:
 A. both θ and w increase
 B. both θ and w decrease
 C. θ remains the same and w increases
 D. θ remains the same and w decreases
 E. θ decreases and w increases
 ans: C

56. At a diffraction line phasors associated with waves from the slits of a multiple-slit barrier:
- A. are aligned
 - B. form a closed polygon
 - C. form a polygon with several sides missing
 - D. are parallel but adjacent phasors point in opposite directions
 - E. form the arc of a circle
- ans: A
57. For a certain multiple-slit barrier the slit separation is 4 times the slit width. For this system:
- A. the orders of the lines that appear are all multiples of 4
 - B. the orders of lines that appear are all multiples of 2
 - C. the orders of the missing lines are all multiples of 4
 - D. the orders of the missing lines are all multiples of 2
 - E. none of the above are true
- ans: C
58. The dispersion D of a grating can have units:
- A. cm
 - B. $1/\text{nm}$
 - C. nm/cm
 - D. radian
 - E. none of these
- ans: B
59. The resolving power R of a grating can have units:
- A. cm
 - B. degree/nm
 - C. watt
 - D. nm/cm
 - E. watt/nm
- ans: D
60. The dispersion of a diffraction grating indicates:
- A. the resolution of the grating
 - B. the separation of lines of the same order
 - C. the number of rulings in the grating
 - D. the width of the lines
 - E. the separation of lines of different order for the same wavelength
- ans: B

61. The resolving power of a diffraction grating is defined by $R = \lambda/\Delta\lambda$. Here λ and $\lambda + \Delta\lambda$ are:
- A. any two wavelengths
 - B. any two wavelengths that are nearly the same
 - C. two wavelengths for which lines of the same order are separated by π radians
 - D. two wavelengths for which lines of the same order are separated by 2π radians
 - E. two wavelengths for which lines of the same order are separated by half the width of a maximum
- ans: E
62. A light beam incident on a diffraction grating consists of waves with two different wavelengths. The separation of the two first order lines is great if:
- A. the dispersion is great
 - B. the resolution is great
 - C. the dispersion is small
 - D. the resolution is small
 - E. none of the above (line separation does not depend on either dispersion or resolution)
- ans: A
63. To obtain greater dispersion by a diffraction grating:
- A. the slit width should be increased
 - B. the slit width should be decreased
 - C. the slit separation should be increased
 - D. the slit separation should be decreased
 - E. more slits with the same width and separation should be added to the system
- ans: D
64. Two nearly equal wavelengths of light are incident on an N -slit grating. The two wavelengths are not resolvable. When N is increased they become resolvable. This is because:
- A. more light gets through the grating
 - B. the lines get more intense
 - C. the entire pattern spreads out
 - D. there are more orders present
 - E. the lines become more narrow
- ans: E
65. A diffraction grating just resolves the wavelengths 400.0 nm and 400.1 nm in first order. The number of slits in the grating is:
- A. 400
 - B. 1000
 - C. 2500
 - D. 4000
 - E. not enough information is given
- ans: D

66. What is the minimum number of slits required in a diffraction grating to just resolve light with wavelengths of 471.0 nm and 471.6 nm?
- A. 99
 - B. 197
 - C. 393
 - D. 786
 - E. 1179
- ans: C
67. X rays are:
- A. electromagnetic waves
 - B. negatively charged ions
 - C. rapidly moving electrons
 - D. rapidly moving protons
 - E. rapidly moving neutrons
- ans: A
68. Bragg's law for x-ray diffraction is $2d \sin \theta = m\lambda$, where θ is the angle between the incident beam and:
- A. a reflecting plane of atoms
 - B. the normal to a reflecting plane of atoms
 - C. the scattered beam
 - D. the normal to the scattered beam
 - E. the refracted beam
- ans: A
69. Bragg's law for x-ray diffraction is $2d \sin \theta = m\lambda$, where the quantity d is:
- A. the height of a unit cell
 - B. the smallest interatomic distance
 - C. the distance from detector to sample
 - D. the distance between planes of atoms
 - E. the usual calculus symbol for a differential
- ans: D
70. Which of the following is true for Bragg diffraction but not for diffraction from a grating?
- A. Two different wavelengths may be used
 - B. For a given wavelength, a maximum may exist in several directions
 - C. Long waves are deviated more than short ones
 - D. There is only one grating spacing
 - E. Maxima occur only for particular angles of incidence
- ans: E

71. The longest x-ray wavelength that can be diffracted by crystal planes with a separation of 0.316 nm is:
- A. 0.158 nm
 - B. 0.316 nm
 - C. 0.474 nm
 - D. 0.632 nm
 - E. 1.26 nm
- ans: D
72. A beam of x rays of wavelength 0.20 nm is diffracted by a set of planes in a crystal whose separation is 3.1×10^{-8} cm. The smallest angle between the beam and the crystal planes for which a reflection occurs is:
- A. 0.70 rad
 - B. 0.33 rad
 - C. 0.033 rad
 - D. 0.066 rad
 - E. no such angle exists
- ans: C
73. An x-ray beam of wavelength 3×10^{-11} m is incident on a calcite crystal of lattice spacing 0.3 nm. The smallest angle between crystal planes and the x-ray beam that will result in constructive interference is:
- A. 2.87°
 - B. 5.73°
 - C. 11.63°
 - D. 23.27°
 - E. none of these
- ans: A
74. A beam of x rays of wavelength 0.10 nm is found to diffract in second order from the face of a LiF crystal at a Bragg angle of 30° . The distance between adjacent crystal planes, in nm, is about:
- A. 0.15
 - B. 0.20
 - C. 0.25
 - D. 0.30
 - E. 0.40
- ans: B

Chapter 37: SPECIAL THEORY OF RELATIVITY

1. A basic postulate of Einstein's theory of relativity is:
 - A. moving clocks run more slowly than when they are at rest
 - B. moving rods are shorter than when they are at rest
 - C. light has both wave and particle properties
 - D. the laws of physics must be the same for observers moving with uniform velocity relative to each other
 - E. everything is relativeans: D

2. A consequence of Einstein's theory of relativity is:
 - A. moving clocks run more slowly than when they are at rest
 - B. moving rods are longer than when they are at rest
 - C. light has both wave and particle properties
 - D. the laws of physics must appear the same to all observers moving with uniform velocity relative to each other
 - E. everything is relativeans: A

3. A consequence of Einstein's theory of relativity is:
 - A. moving clocks run faster than when they are at rest
 - B. moving rods are shorter than when they are at rest
 - C. light has both wave and particle properties
 - D. the laws of physics must appear the same to all observers moving with uniform velocity relative to each other
 - E. everything is relativeans: B

4. According to the theory of relativity:
 - A. moving clocks run fast
 - B. energy is not conserved in high speed collisions
 - C. the speed of light must be measured relative to the ether
 - D. momentum is not conserved in high speed collisions
 - E. none of the above are trueans: E

5. Two events occur simultaneously on the x axis of reference frame S, one at $x = -a$ and the other at $x = +a$. According to an observer moving in the positive x direction:
 - A. the event at $x = +a$ occurs first
 - B. the event at $x = -a$ occurs first
 - C. either event might occur first, depending on the value of a and the observer's speed
 - D. the events are simultaneous
 - E. none of the aboveans: A

6. Two events occur simultaneously at separated points on the y axis of reference frame S . According to an observer moving in the positive x direction:
- A. the event with the greater y coordinate occurs first
 - B. the event with the greater y coordinate occurs last
 - C. either event might occur first, depending on the observer's speed
 - D. the events are simultaneous
 - E. none of the above
- ans: D
7. A train traveling very fast ($v = 0.6c$) has an engineer (E) at the front, a guard (G) at the rear, and an observer (S') exactly half way between them. Both E and G are equipped with yellow signaling lamps. The train passes a station, closely observed by the station master (S). Both E and G use their lamps to send signals. According to both S and S' these signals arrive simultaneously at the instant S' is passing S. According to S' :
- A. E and G sent their signals simultaneously from different distances
 - B. G sent his signal before E and from farther away
 - C. G sent his signal before E but was the same distance away
 - D. E sent his signal before G and from farther away
 - E. none of the above
- ans: E
8. The proper time between two events is measured by clocks at rest in a reference frame in which the two events:
- A. occur at the same time
 - B. occur at the same coordinates
 - C. are separated by the distance a light signal can travel during the time interval
 - D. occur in Boston
 - E. satisfy none of the above
- ans: B
9. The spaceship U.S.S. Enterprise, traveling through the galaxy, sends out a smaller explorer craft that travels to a nearby planet and signals its findings back. The proper time for the trip to the planet is measured by clocks:
- A. on board the Enterprise
 - B. on board the explorer craft
 - C. on Earth
 - D. at the center of the galaxy
 - E. none of the above
- ans: B

10. Spaceship A, traveling past us at $0.7c$, sends a message capsule to spaceship B, which is in front of A and is traveling in the same direction as A at $0.8c$ relative to us. The capsule travels at $0.95c$ relative to us. A clock that measures the proper time between the sending and receiving of the capsule travels:
- A. in the same direction as the spaceships at $0.7c$ relative to us
 - B. in the opposite direction from the spaceships at $0.7c$ relative to us
 - C. in the same direction as the spaceships at $0.8c$ relative to us
 - D. in the same direction as the spaceships at $0.95c$ relative to us
 - E. in the opposite direction from the spaceships at $0.95c$ relative to us

ans: D

11. Two events occur on the x axis separated in time by Δt and in space by Δx . A reference frame, traveling at less than the speed of light, in which the two events occur at the same time:
- A. exists no matter what the values of Δx and Δt
 - B. exists only if $\Delta x/\Delta t < c$
 - C. exists only if $\Delta x/\Delta t > c$
 - D. exists only if $\Delta x/\Delta t = c$
 - E. does not exist under any condition

ans: C

12. Two events occur on the x axis separated in time by Δt and in space by Δx . A reference frame, traveling at less than the speed of light, in which the two events occur at the same coordinate:
- A. exists no matter what the values of Δx and Δt
 - B. exists only if $\Delta x/\Delta t < c$
 - C. exists only if $\Delta x/\Delta t > c$
 - D. exists only if $\Delta x/\Delta t = c$
 - E. does not exist under any condition

ans: B

13. As we watch, a spaceship passes us in time Δt . The crew of the spaceship measures the passage time and finds it to be $\Delta t'$. Which of the following statements is true?
- A. Δt is the proper time for the passage and it is smaller than $\Delta t'$
 - B. Δt is the proper time for the passage and it is greater than $\Delta t'$
 - C. $\Delta t'$ is the proper time for the passage and it is smaller than Δt
 - D. $\Delta t'$ is the proper time for the passage and it is greater than Δt
 - E. None of the above statements are true.

ans: C

14. A millionairess was told in 1992 that she had exactly 15 years to live. However, if she travels away from the Earth at $0.8c$ and then returns at the same speed, the last New Year's day the doctors expect her to celebrate is:
- A. 2001
 - B. 2003
 - C. 2007
 - D. 2010
 - E. 2017

ans: E

15. Two events occur 100 m apart with an intervening time interval of $0.60 \mu\text{s}$. The speed of a reference frame in which they occur at the same coordinate is:
- A. 0
 - B. $0.25c$
 - C. $0.56c$
 - D. $1.1c$
 - E. $1.8c$
- ans: C
16. Two independent events occur 100 m apart with an intervening time interval of $0.42 \mu\text{s}$. The proper time in μs between the events is:
- A. 0
 - B. 0.16
 - C. 0.26
 - D. 0.42
 - E. 0.69
- ans: C
17. Two events occur 100 m apart with an intervening time interval of $0.37 \mu\text{s}$. The speed of a clock that measures the proper time between the events is:
- A. 0
 - B. $0.45c$
 - C. $0.56c$
 - D. $0.90c$
 - E. $1.8c$
- ans: D
18. A rocket traveling with constant velocity makes a 8.4×10^{15} m trip in exactly one year. The proper time in years between events that mark the beginning and end of the trip is:
- A. 0.21
 - B. 0.46
 - C. 1.0
 - D. 2.2
 - E. 4.7
- ans: B
19. An observer notices that a moving clock runs slow by a factor of exactly 10. The speed of the clock is:
- A. $0.100c$
 - B. $0.0100c$
 - C. $0.990c$
 - D. $0.900c$
 - E. $0.995c$
- ans: E

20. A meson when at rest decays $2\ \mu\text{s}$ after it is created. If moving in the laboratory at $0.99c$, its lifetime according to laboratory clocks would be:
- the same
 - $0.28\ \mu\text{s}$
 - $14\ \mu\text{s}$
 - $4.6\ \text{s}$
 - none of these
- ans: C
21. Pi mesons at rest have a half-life of T . If a beam of pi mesons is traveling at a speed of $v = \beta c$, the distance in which the intensity of the beam is halved is:
- $c\beta T(1 - \beta^2)^{-1/2}$
 - $c\beta T[(1 + \beta)/(1 - \beta)]^{1/2}$
 - $\beta v T$
 - $(1 - \beta^2)^{1/2} v T$
 - none of the above
- ans: A
22. A meson moving through a laboratory of length x at a speed v decays after a lifetime T as measured by an observer at rest in the laboratory. If the meson were at rest in the laboratory its lifetime would be:
- $T(1 - v/c)$
 - $T(1 - v/c)^{-1}$
 - $T(1 - v^2/c^2)^{-1/2}$
 - $T(1 - v^2/c^2)^{1/2}$
 - $(T - vx/c^2)(1 - v^2/c^2)^{-1/2}$
- ans: D
23. A measurement of the length of an object that is moving relative to the laboratory consists of noting the coordinates of the front and back:
- at different times according to clocks at rest in the laboratory
 - at the same time according to clocks that move with the object
 - at the same time according to clocks at rest in the laboratory
 - at the same time according to clocks at rest with respect to the fixed stars
 - none of the above
- ans: C
24. A meter stick moves in the direction of its length through a laboratory. According to measurements taken in the laboratory, its length is $0.31\ \text{m}$. The speed of the meter stick relative to the laboratory is:
- $0.096c$
 - $0.31c$
 - $0.69c$
 - $0.83c$
 - $0.95c$
- ans: E

25. A meter stick moves sideways at $0.95c$. According to measurements taken in the laboratory, its length is:
- A. 0
 - B. 0.098 m
 - C. 0.31 m
 - D. 3.2 m
 - E. 1.0 m
- ans: E
26. A rocket ship of rest length 100 m is moving at speed $0.8c$ past a timing device that records the time interval between the passage of the front and back ends of the ship. This time interval is:
- A. $0.20 \mu\text{s}$
 - B. $0.25 \mu\text{s}$
 - C. $0.33 \mu\text{s}$
 - D. $0.52 \mu\text{s}$
 - E. $0.69 \mu\text{s}$
- ans: B
27. The length of a meter stick moving at $0.95c$ in the direction of its length is measured by simultaneously marking its ends on a stationary axis. As measured by clocks moving with the stick, the time interval between the making of the back mark and the making of the front mark is:
- A. 0
 - B. $3.1 \times 10^{-10} \text{ s}$
 - C. $1.0 \times 10^{-9} \text{ s}$
 - D. $3.2 \times 10^{-9} \text{ s}$
 - E. $1.0 \times 10^{-8} \text{ s}$
- ans: D
28. A certain automobile is 6 m long if at rest. If it is measured to be $4/5$ as long, its speed is:
- A. $0.1c$
 - B. $0.3c$
 - C. $0.6c$
 - D. $0.8c$
 - E. $> 0.95c$
- ans: C
29. As a rocket ship moves by at $0.95c$ a mark is made on a stationary axis at the front end of the rocket and $9 \times 10^{-8} \text{ s}$ later a mark is made on the axis at the back end. The marks are found to be 100 m apart. The rest length of the rocket is:
- A. 31 m
 - B. 78 m
 - C. 100 m
 - D. 240 m
 - E. 320 m
- ans: D

30. A clock is moving along the x axis at $0.6c$. It reads zero as it passes the origin ($x = 0$). When it passes the $x = 180$ m mark on the x axis the clock reads:
- $0.60 \mu\text{s}$
 - $0.80 \mu\text{s}$
 - $1.00 \mu\text{s}$
 - $1.25 \mu\text{s}$
 - $1.67 \mu\text{s}$
- ans: B
31. Relative to reference frame 1, reference frame 2 moves with speed v in the negative x direction. When the origins of the two frames coincide the clocks in both frames are set to zero. An event occurs at coordinate x_1 and time t_1 as measured in reference frame 1 and at coordinate x_2 and time t_2 as measured in frame 2. If $\gamma = 1/\sqrt{1 - v^2/c^2}$, then the coordinates and times of the event are related by:
- $x_2 = \gamma[x_1 - vt_1]$ and $t_2 = \gamma[t_1 - vx_1/c^2]$
 - $x_2 = \gamma[x_1 - vt_1]$ and $t_2 = \gamma[t_1 + vx_1/c^2]$
 - $x_2 = \gamma[x_1 + vt_1]$ and $t_2 = \gamma[t_1 - vx_1/c^2]$
 - $x_2 = \gamma[x_1 + vt_1]$ and $t_2 = \gamma[t_1 + vx_1/c^2]$
 - none of the above are correct
- ans: D
32. An event occurs at $x = 500$ m, $t = 0.90 \mu\text{s}$ in one frame of reference. Another frame is moving at $0.90c$ in the positive x direction. The origins coincide at $t = 0$ and clocks in the second frame are zeroed when the origins coincide. The coordinate and time of the event in the second frame are:
- 500 m, $0.90 \mu\text{s}$
 - 1700 m, $5.5 \mu\text{s}$
 - 740 m, $2.4 \mu\text{s}$
 - 260 m, $-0.60 \mu\text{s}$
 - 590 m, $-1.4 \mu\text{s}$
- ans: E
33. An event occurs at $x = 500$ m, $t = 0.90 \mu\text{s}$ in one frame of reference. Another frame is moving at $0.90c$ in the negative x direction. The origins coincide at $t = 0$ and clocks in the second frame are zeroed when the origins coincide. The coordinate and time of the event in the second frame are:
- 500 m, $0.90 \mu\text{s}$
 - 1700 m, $5.5 \mu\text{s}$
 - 740 m, $2.4 \mu\text{s}$
 - 260 m, $-0.60 \mu\text{s}$
 - 590 m, $-1.4 \mu\text{s}$
- ans: B

34. Two flashes of light occur simultaneously at $t = 0$ in reference frame S, one at $x = 0$ and the other at $x = 600$ m. They are observed in reference frame S', which is moving at $0.95c$ in the positive x direction. The origins of the two frames coincide at $t = 0$ and the clocks of S' are zeroed when the origins coincide. In S' the coordinate where the leading edges of the two light flashes meet and the time when they meet are:
- 300 m, $1.0 \mu\text{s}$
 - 15 m, $0.050 \mu\text{s}$
 - 585 m, $1.95 \mu\text{s}$
 - 49 m, $0.16 \mu\text{s}$
 - 1900 m, $0.16 \mu\text{s}$
- ans: D
35. Frame S' moves in the positive x direction at $0.6c$ with respect to frame S. A particle moves in the positive x direction at $0.4c$ as measured by an observer in S'. The speed of the particle as measured by an observer in S is:
- $c/5$
 - $5c/19$
 - $8c/25$
 - $25c/31$
 - c
- ans: D
36. Star S1 is moving away from us at a speed of $0.8c$. Star S2 is moving away from us in the opposite direction at a speed of $0.5c$. The speed of S1 as measured by an observer on S2 is:
- $0.21c$
 - $0.5c$
 - $0.93c$
 - $1.3c$
 - $2.17c$
- ans: C
37. Observer A measures the velocity of a rocket as \vec{v} and a comet as \vec{u} . Here \vec{u} and \vec{v} are parallel and in the direction of the observer's positive x axis. The speed of the comet as measured by observer B on the rocket is:
- $(u - v)/(1 - uv/c^2)$
 - $(u - v)/(1 - v^2/c^2)$
 - $(u - v)/(1 - v^2/c^2)^{1/2}$
 - $(u - v)/(1 + uv/c^2)$
 - $(u + v)/(1 - uv/c^2)$
- ans: A

38. Two electrons move in opposite directions at $0.70c$ as measured in the laboratory. The speed of one electron as measured from the other is:
- $0.35c$
 - $0.70c$
 - $0.94c$
 - $1.00c$
 - $1.40c$
- ans: C

39. Light from some stars shows an apparent change in frequency because of:
- interference
 - refraction by layers of air
 - diffraction
 - reflection
 - relative motion
- ans: E

40. While emitting light of proper frequency f_0 , a source moves to the right with speed $c/4$ relative to reference frame S. A detector, to the left of the source, measures the frequency to be f , which is greater than f_0 . This means:

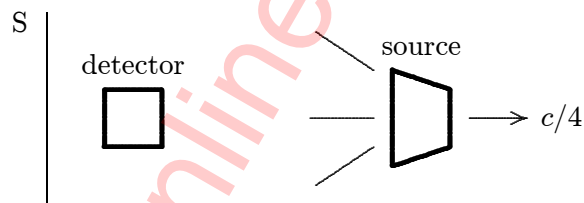

- the detector is moving to the right with a speed that is greater than $c/4$ relative to S
 - the detector is moving to the right with a speed that is less than $c/4$ relative to S
 - the detector is moving to the left with a speed that is greater than $c/4$ relative to S
 - the detector is moving to the left with a speed that is less than $c/4$ relative to S
 - the detector is not moving
- ans: A
41. Light from a stationary spaceship is observed, then the spaceship moves directly away from the observer at high speed while still emitting the light. As a result, the light seen by the observer has:
- a higher frequency and a longer wavelength than before
 - a lower frequency and a shorter wavelength than before
 - a higher frequency and a shorter wavelength than before
 - a lower frequency and a longer wavelength than before
 - the same frequency and wavelength as before
- ans: D

42. A train traveling very fast ($v = 0.6c$) has an engineer (E) at the front, a guard (G) at the rear, and a passenger (S') exactly halfway between them. Both E and G are equipped with yellow signaling lamps. The train passes a station, closely observed by the station master (S). Both E and G use their lamps to send signals. According to both S and S' these signals arrive simultaneously at the instant S' is passing S. According to S, the signal from E will look _____ and that from G will look _____.
- A. red, blue
 - B. yellow, yellow
 - C. blue, red
 - D. blue, blue
 - E. red, red
- ans: A
43. A console lamp in the cabin of a spaceship appears green when the ship and observer are both at rest on Earth. When the ship is moving at $0.90c$ away from Earth, passengers on board see:
- A. nothing (the frequency is too high to be seen)
 - B. nothing (the frequency is too low to be seen)
 - C. a red lamp
 - D. a violet lamp
 - E. a green lamp
- ans: E
44. A spectral line of a certain star is observed to be "red shifted" from a wavelength of 500 nm to a wavelength of 1500 nm. Interpreting this as a Doppler effect, the speed of recession of this star is:
- A. $0.33c$
 - B. $0.50c$
 - C. $0.71c$
 - D. $0.8c$
 - E. c
- ans: D
45. A source at rest emits light of wavelength 500 nm. When it is moving at $0.90c$ toward an observer, the observer detects light of wavelength:
- A. 26 nm
 - B. 115 nm
 - C. 500 nm
 - D. 2200 nm
 - E. 9500 nm
- ans: B

46. A source at rest emits light of wavelength 500 nm. When it is moving at $0.90c$ away from an observer, the observer detects light of wavelength:
- A. 26 nm
 - B. 115 nm
 - C. 500 nm
 - D. 2200 nm
 - E. 9500 nm
- ans: D
47. Visible light, with a frequency of 6.0×10^{14} Hz, is reflected from a spaceship moving directly away at a speed of $0.90c$. The frequency of the reflected waves observed at the source is:
- A. 3.2×10^{13} Hz
 - B. 1.4×10^{14} Hz
 - C. 6.0×10^{14} Hz
 - D. 2.6×10^{15} Hz
 - E. 1.1×10^{16} Hz
- ans: A
48. How fast should you move away from a 6.0×10^{14} Hz light source to observe waves with a frequency of 4.0×10^{14} Hz?
- A. $0.20c$
 - B. $0.38c$
 - C. $0.45c$
 - D. $0.51c$
 - E. $0.76c$
- ans: B
49. A particle with rest mass m moves with speed $0.6c$. Its kinetic energy is:
- A. $0.18mc^2$
 - B. $0.22mc^2$
 - C. $0.25mc^2$
 - D. mc^2
 - E. $1.25mc^2$
- ans: C
50. An electron is moving at $0.6c$. If we calculate its kinetic energy using $(1/2)mv^2$, we get a result that is:
- A. just right
 - B. just half enough
 - C. twice the correct value
 - D. about 1% too low
 - E. about 28% too low
- ans: E

51. The velocity of an electron is changed from $c/2$ in the $-x$ direction to $c/2$ in the $+x$ direction. As a result, its kinetic energy changes by:
- A. mc^2
 - B. $0.5mc^2$
 - C. $\sqrt{2}mc^2$
 - D. $2mc^2$
 - E. zero
- ans: E
52. The work that must be done to increase the speed of an electron ($m = 9.11 \times 10^{-31}$ kg) from $0.90c$ to $0.95c$ is:
- A. 2.6×10^{-13} J
 - B. 8.2×10^{-13} J
 - C. 3.2×10^{-13} J
 - D. 7.4×10^{-14} J
 - E. 3.8×10^{-15} J
- ans: D
53. An electron ($m = 9.11 \times 10^{-31}$ kg) has a speed of $0.95c$. Its kinetic energy is:
- A. 8.2×10^{-14} J
 - B. 1.8×10^{-13} J
 - C. 2.0×10^{-13} J
 - D. 2.2×10^{-13} J
 - E. 2.6×10^{-13} J
- ans: B
54. An electron ($m = 9.11 \times 10^{-31}$ kg) has a speed of $0.95c$. The magnitude of its momentum is:
- A. 2.6×10^{-22} kg · m/s
 - B. 2.9×10^{-22} kg · m/s
 - C. 6.0×10^{-22} kg · m/s
 - D. 8.3×10^{-22} kg · m/s
 - E. 8.8×10^{-22} kg · m/s
- ans: D
55. According to the special theory of relativity:
- A. all forms of energy have mass-like properties
 - B. moving particles lose mass
 - C. momentum is not conserved in high speed collisions
 - D. a rod moving rapidly sideways is shorter along its length
 - E. a rod moving rapidly sideways is longer along its length
- ans: A

56. The mass of a particle is m . In order for its total energy to be twice its rest energy, its momentum must be:
- A. $mc/2$
 - B. $mc/\sqrt{2}$
 - C. mc
 - D. $\sqrt{3}mc$
 - E. $2mc$
- ans: D
57. If the kinetic energy of a particle is equal to its rest energy then its speed must be:
- A. $0.25c$
 - B. $0.50c$
 - C. $0.87c$
 - D. c
 - E. unknown unless its mass is given
- ans: C
58. If the mass of a particle is zero its speed must be:
- A. c
 - B. infinite
 - C. 0
 - D. any speed less than c
 - E. any speed greater than c
- ans: A
59. A particle with zero mass and energy E carries momentum:
- A. Ec
 - B. Ec^2
 - C. \sqrt{Ec}
 - D. E/c
 - E. E/c^2
- ans: D
60. According to relativity theory a particle of mass m with a momentum of $2mc$ has a speed of:
- A. $2c$
 - B. $4c$
 - C. c
 - D. $c/2$
 - E. $0.89c$
- ans: E

61. If the kinetic energy of a free particle is much greater than its rest energy then its kinetic energy is proportional to:
- A. the magnitude of its momentum
 - B. the square of the magnitude of its momentum
 - C. the square root of the magnitude of its momentum
 - D. the reciprocal of the magnitude of its momentum
 - E. none of the above
- ans: A
62. If the kinetic energy of a free particle is much less than its rest energy then its kinetic energy is proportional to:
- A. the magnitude of its momentum
 - B. the square of the magnitude of its momentum
 - C. the square root of the magnitude of its momentum
 - D. the reciprocal of the magnitude of its momentum
 - E. none of the above
- ans: B
63. The magnitude of the momentum of a particle can never exceed:
- A. mc , where m is its mass
 - B. E/c , where E is its total energy
 - C. K/c , where K is its kinetic energy
 - D. none of the above, but there is an upper limit
 - E. none of the above; there is no upper limit
- ans: B
64. An electron ($m = 9.11 \times 10^{-31}$ kg) has a momentum of 4.0×10^{-22} kg · m/s. Its kinetic energy is:
- A. 6.3×10^{-14} J
 - B. 8.2×10^{-14} J
 - C. 1.2×10^{-13} J
 - D. 1.5×10^{-13} J
 - E. 2.7×10^{-13} J
- ans: A
65. A certain particle has a kinetic energy of 3.2×10^{-10} J and a momentum of 1.7×10^{-18} kg · m/s. Its mass is:
- A. 9.11×10^{-31} kg
 - B. 2.7×10^{-27} kg
 - C. 4.5×10^{-27} kg
 - D. 6.3×10^{-27} kg
 - E. 8.6×10^{-27} kg
- ans: B

66. An electron ($m = 9.11 \times 10^{-31}$ kg, $q = 1.60 \times 10^{-19}$ C) travels at $0.95c$ around a circular orbit perpendicular to a uniform 1.8-T magnetic field. The radius of its orbit is:
- A. 0.28 mm
 - B. 0.90 mm
 - C. 1.1 mm
 - D. 2.9 mm
 - E. 4.7 mm
- ans: D

67. An electron ($m = 9.11 \times 10^{-31}$ kg, $q = 1.60 \times 10^{-19}$ C) travels around a 1.7-mm radius circular orbit perpendicular to a 2.8-T magnetic field. Its speed is:
- A. $0.16c$
 - B. $0.36c$
 - C. $0.94c$
 - D. c
 - E. $2.8c$
- ans: C

www.allonlinefree.com

Chapter 38: PHOTONS AND MATTER WAVES

- The units of the Planck constant h are those of:
 - energy
 - power
 - momentum
 - angular momentum
 - frequencyans: D
- If h is the Planck constant, then \hbar is:
 - $2\pi h$
 - $2h$
 - $h/2$
 - $h/2\pi$
 - $2h/\pi$ans: D
- The quantization of energy, $E = nhf$, is not important for an ordinary pendulum because:
 - the formula applies only to mass-spring oscillators
 - the allowed energy levels are too closely spaced
 - the allowed energy levels are too widely spaced
 - the formula applies only to atoms
 - the value of h for a pendulum is too largeans: B
- The frequency of light beam A is twice that of light beam B. The ratio E_A/E_B of photon energies is:
 - $1/2$
 - $1/4$
 - 1
 - 2
 - 4ans: D
- The wavelength of light beam B is twice the wavelength of light beam A. The energy of a photon in beam A is:
 - half the energy of a photon in beam B
 - one-fourth the energy of a photon in beam B
 - equal to the energy of a photon in beam B
 - twice the energy of a photon in beam B
 - four times the energy of a photon in beam Bans: A

6. A photon in light beam A has twice the energy of a photon in light beam B. The ratio p_A/p_B of their momenta is:
- A. $1/2$
 - B. $1/4$
 - C. 1
 - D. 2
 - E. 4

ans: D

7. Which of the following electromagnetic radiations has photons with the greatest energy?
- A. blue light
 - B. yellow light
 - C. x rays
 - D. radio waves
 - E. microwaves

ans: C

8. Which of the following electromagnetic radiations has photons with the greatest momentum?
- A. blue light
 - B. yellow light
 - C. x rays
 - D. radio waves
 - E. microwaves

ans: C

9. Rank following electromagnetic radiations according to the energies of their photons, from least to greatest.
- 1. blue light
 - 2. yellow light
 - 3. x rays
 - 4. radio waves

- A. 1, 2, 3, 4
- B. 4, 2, 1, 3
- C. 4, 1, 2, 3
- D. 3, 2, 1, 4
- E. 3, 1, 2, 4

ans: B

10. The intensity of a uniform light beam with a wavelength of 500 nm is 2000 W/m^2 . The photon flux (in number/ $\text{m}^2 \cdot \text{s}$) is about:
- A. 5×10^{17}
 - B. 5×10^{19}
 - C. 5×10^{21}
 - D. 5×10^{23}
 - E. 5×10^{25}

ans: C

11. The concentration of photons in a uniform light beam with a wavelength of 500 nm is $1.7 \times 10^{13} \text{ m}^{-3}$. The intensity of the beam is:
- A. $6.7 \times 10^{-6} \text{ W/m}^2$
 - B. $1.0 \times 10^3 \text{ W/m}^2$
 - C. $2.0 \times 10^3 \text{ W/m}^2$
 - D. $4.0 \times 10^3 \text{ W/m}^2$
 - E. $3.2 \times 10^2 \text{ W/m}^2$
- ans: C
12. Light beams A and B have the same intensity but the wavelength associated with beam A is longer than that associated with beam B. The photon flux (number crossing a unit area per unit time) is:
- A. greater for A than for B
 - B. greater for B than for A
 - C. the same for A and B
 - D. greater for A than for B only if both have short wavelengths
 - E. greater for B than for A only if both have short wavelengths
- ans: A
13. In a photoelectric effect experiment the stopping potential is:
- A. the energy required to remove an electron from the sample
 - B. the kinetic energy of the most energetic electron ejected
 - C. the potential energy of the most energetic electron ejected
 - D. the photon energy
 - E. the electric potential that causes the electron current to vanish
- ans: E
14. In a photoelectric effect experiment at a frequency above cut off, the stopping potential is proportional to:
- A. the energy of the least energetic electron before it is ejected
 - B. the energy of the least energetic electron after it is ejected
 - C. the energy of the most energetic electron before it is ejected
 - D. the energy of the most energetic electron after it is ejected
 - E. the electron potential energy at the surface of the sample
- ans: D
15. In a photoelectric effect experiment at a frequency above cut off, the number of electrons ejected is proportional to:
- A. their kinetic energy
 - B. their potential energy
 - C. the work function
 - D. the frequency of the incident light
 - E. the number of photons that hit the sample
- ans: E

16. In a photoelectric effect experiment no electrons are ejected if the frequency of the incident light is less than A/h , where h is the Planck constant and A is:
- the maximum energy needed to eject the least energetic electron
 - the minimum energy needed to eject the least energetic electron
 - the maximum energy needed to eject the most energetic electron
 - the minimum energy needed to eject the most energetic electron
 - the intensity of the incident light

ans: D

17. The diagram shows the graphs of the stopping potential as a function of the frequency of the incident light for photoelectric experiments performed on three different materials. Rank the materials according to the values of their work functions, from least to greatest.

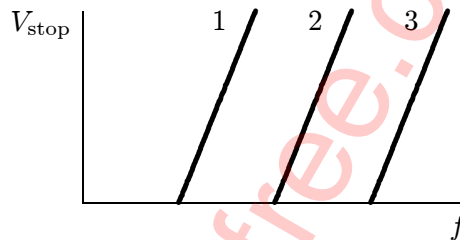

- 1, 2, 3
- 3, 2, 1
- 2, 3, 1
- 2, 1, 3
- 1, 3, 2

ans: A

18. The work function for a certain sample is 2.3 eV. The stopping potential for electrons ejected from the sample by 7.0×10^{14} -Hz electromagnetic radiation is:
- 0
 - 0.60 V
 - 2.3 V
 - 2.9 V
 - 5.2 V

ans: B

19. The stopping potential for electrons ejected by 6.8×10^{14} -Hz electromagnetic radiation incident on a certain sample is 1.8 V. The kinetic energy of the most energetic electrons ejected and the work function of the sample, respectively, are:
- 1.8 eV, 2.8 eV
 - 1.8 eV, 1.0 eV
 - 1.8 eV, 4.6 eV
 - 2.8 eV, 1.0 eV
 - 1.0 eV, 4.6 eV

ans: B

20. Separate Compton effect experiments are carried out using visible light and x rays. The scattered radiation is observed at the same scattering angle. For these experiments:
- A. the x rays have the greater shift in wavelength and the greater change in photon energy
 - B. the two radiations have the same shift in wavelength and the x rays have the greater change in photon energy
 - C. the two radiations have the same shift in wavelength and the visible light has the greater change in photon energy
 - D. the two radiations have the same shift in wavelength and the same change in photon energy
 - E. the visible light has the greater shift in wavelength and the greater shift in photon energy
- ans: B
21. In Compton scattering from stationary particles the maximum change in wavelength can be made smaller by using:
- A. higher frequency radiation
 - B. lower frequency radiation
 - C. more massive particles
 - D. less massive particles
 - E. particles with greater charge
- ans: C
22. Of the following, Compton scattering from electrons is most easily observed for:
- A. microwaves
 - B. infrared light
 - C. visible light
 - D. ultraviolet light
 - E. x rays
- ans: E
23. In Compton scattering from stationary electrons the largest change in wavelength occurs when the photon is scattered through:
- A. 0°
 - B. 22.5°
 - C. 45°
 - D. 90°
 - E. 180°
- ans: E
24. In Compton scattering from stationary electrons the frequency of the emitted light is independent of:
- A. the frequency of the incident light
 - B. the speed of the electron
 - C. the scattering angle
 - D. the electron recoil energy
 - E. none of the above
- ans: E

25. In Compton scattering from stationary electrons the largest change in wavelength that can occur is:
- A. 2.43×10^{-15} m
 - B. 2.43×10^{-12} m
 - C. 2.43×10^{-9} m
 - D. dependent on the frequency of the incident light
 - E. dependent on the work function
- ans: B
26. Electromagnetic radiation with a wavelength of 5.7×10^{-12} m is incident on stationary electrons. Radiation that has a wavelength of 6.57×10^{-12} m is detected at a scattering angle of:
- A. 10°
 - B. 121°
 - C. 40°
 - D. 50°
 - E. 69°
- ans: D
27. Electromagnetic radiation with a wavelength of 3.5×10^{-12} m is scattered from stationary electrons and photons that have been scattered through 50° are detected. An electron from which one of these photons was scattered receives an energy of:
- A. 0
 - B. 1.1×10^{-14} J
 - C. 1.9×10^{-14} J
 - D. 2.3×10^{-14} J
 - E. 1.3×10^{-13} J
- ans: B
28. Electromagnetic radiation with a wavelength of 3.5×10^{-12} m is scattered from stationary electrons and photons that have been scattered through 50° are detected. After a scattering event the magnitude of the electron's momentum is:
- A. 0
 - B. 1.5×10^{-22} kg · m/s
 - C. 2.0×10^{-22} kg · m/s
 - D. 2.2×10^{-22} kg · m/s
 - E. 8.7×10^{-23} kg · m/s
- ans: B

29. Consider the following:
1. a photoelectric process in which some emitted electrons have kinetic energy greater than hf , where f is the frequency of the incident light.
 2. a photoelectric process in which all emitted electrons have energy less than hf .
 3. Compton scattering from stationary electrons for which the emitted light has a wavelength that is greater than that of the incident light.
 4. Compton scattering from stationary electrons for which the emitted light has a wavelength that is less than that of the incident light.

The only possible processes are:

- A. 1
- B. 3
- C. 1 and 3
- D. 2 and 3
- E. 2 and 4

ans: D

30. J. J. Thompson's measurement of e/m for electrons provides evidence of the:
- A. wave nature of matter
 - B. particle nature of matter
 - C. wave nature of radiation
 - D. particle nature of radiation
 - E. transverse wave nature of light

ans: B

31. Evidence for the wave nature of matter is:
- A. electron diffraction experiments of Davisson and Germer
 - B. Thompson's measurement of e/m
 - C. Young's double slit experiment
 - D. the Compton effect
 - E. Lenz's law

ans: A

32. Which of the following is NOT evidence for the wave nature of matter?
- A. The photoelectric effect
 - B. The diffraction pattern obtained when electrons pass through a slit
 - C. Electron tunneling
 - D. The validity of the Heisenberg uncertainty principle
 - E. The interference pattern obtained when electrons pass through a two-slit system

ans: A

33. Of the following which is the best evidence for the wave nature of matter?
- A. The photoelectric effect
 - B. The Compton effect
 - C. The spectral radiance of cavity radiation
 - D. The relationship between momentum and energy for an electron
 - E. The reflection of electrons by crystals

ans: E

34. Monoenergetic electrons are incident on a single slit barrier. If the energy of each incident electron is increased the central maximum of the diffraction pattern:
- A. widens
 - B. narrows
 - C. stays the same width
 - D. widens for slow electrons and narrows for fast electrons
 - E. narrows for slow electrons and widens for fast electrons
- ans: B

35. A free electron and a free proton have the same kinetic energy. This means that, compared to the matter wave associated with the proton, the matter wave associated with the electron has:
- A. a shorter wavelength and a greater frequency
 - B. a longer wavelength and a greater frequency
 - C. a shorter wavelength and the same frequency
 - D. a longer wavelength and the same frequency
 - E. a shorter wavelength and a smaller frequency
- ans: D

36. A free electron and a free proton have the same momentum. This means that, compared to the matter wave associated with the proton, the matter wave associated with the electron:
- A. has a shorter wavelength and a greater frequency
 - B. has a longer wavelength and a greater frequency
 - C. has the same wavelength and the same frequency
 - D. has the same wavelength and a greater frequency
 - E. has the same wavelength and a smaller frequency
- ans: D

37. A free electron and a free proton have the same speed. This means that, compared to the matter wave associated with the proton, the matter wave associated with the electron:
- A. has a shorter wavelength and a greater frequency
 - B. has a longer wavelength and a greater frequency
 - C. has the same wavelength and the same frequency
 - D. has the same wavelength and a greater frequency
 - E. has a longer wavelength and a smaller frequency
- ans: E

38. Consider the following three particles:
1. a free electron with speed v_0
 2. a free proton with speed v_0
 3. a free proton with speed $2v_0$

Rank them according to the wavelengths of their matter waves, least to greatest.

- A. 1, 2, 3
 - B. 3, 2, 1
 - C. 2, 3, 1
 - D. 1, 3, 2
 - E. 1, then 2 and 3 tied
- ans: B

39. Consider the following three particles:
1. a free electron with kinetic energy K_0
 2. a free proton with kinetic energy K_0
 3. a free proton with kinetic energy $2K_0$

Rank them according to the wavelengths of their matter waves, least to greatest.

- A. 1, 2, 3
- B. 3, 2, 1
- C. 2, 3, 1
- D. 1, 3, 2
- E. 1, then 2 and 3 tied

ans: B

40. A free electron has a momentum of $5.0 \times 10^{-24} \text{ kg} \cdot \text{m/s}$. The wavelength of its wave function is:

- A. $1.3 \times 10^{-8} \text{ m}$
- B. $1.3 \times 10^{-10} \text{ m}$
- C. $2.1 \times 10^{-11} \text{ m}$
- D. $2.1 \times 10^{-13} \text{ m}$
- E. none of these

ans: B

41. The frequency and wavelength of the matter wave associated with a 10-eV free electron are:

- A. $1.5 \times 10^{34} \text{ Hz}$, $3.9 \times 10^{-10} \text{ m}$
- B. $1.5 \times 10^{34} \text{ Hz}$, $1.3 \times 10^{-34} \text{ m}$
- C. $2.4 \times 10^{15} \text{ Hz}$, $1.2 \times 10^{-9} \text{ m}$
- D. $2.4 \times 10^{15} \text{ Hz}$, $3.9 \times 10^{-10} \text{ m}$
- E. $4.8 \times 10^{15} \text{ Hz}$, $1.9 \times 10^{-10} \text{ m}$

ans: D

42. If the kinetic energy of a non-relativistic free electron doubles, the frequency of its wave function changes by the factor:

- A. $1/\sqrt{2}$
- B. $1/2$
- C. $1/4$
- D. $\sqrt{2}$
- E. 2

ans: E

43. A non-relativistic free electron has kinetic energy K . If its wavelength doubles, its kinetic energy is:

- A. $4K$
- B. $2K$
- C. still K
- D. $K/2$
- E. $K/4$

ans: E

44. The probability that a particle is in a given small region of space is proportional to:
- A. its energy
 - B. its momentum
 - C. the frequency of its wave function
 - D. the wavelength of its wave function
 - E. the square of the magnitude of its wave function
- ans: E
45. $\psi(x)$ is the wave function for a particle moving along the x axis. The probability that the particle is in the interval from $x = a$ to $x = b$ is given by:
- A. $\psi(b) - \psi(a)$
 - B. $|\psi(b)|/|\psi(a)|$
 - C. $|\psi(b)|^2/|\psi(a)|^2$
 - D. $\int_a^b \psi(x) dx$
 - E. $\int_a^b |\psi(x)|^2 dx$
- ans: E
46. The significance of $|\psi|^2$ is:
- A. probability
 - B. energy
 - C. probability density
 - D. energy density
 - E. wavelength
- ans: C
47. Maxwell's equations are to electric and magnetic fields as _____ equation is to the wave function for a particle.
- A. Einstein's
 - B. Fermi's
 - C. Newton's
 - D. Schrödinger's
 - E. Bohr's
- ans: D
48. A free electron in motion along the x axis has a localized wave function. The uncertainty in its momentum is decreased if:
- A. the wave function is made more narrow
 - B. the wave function is made less narrow
 - C. the wave function remains the same but the energy of the electron is increased
 - D. the wave function remains the same but the energy of the electron is decreased
 - E. none of the above
- ans: B

49. The uncertainty in position of an electron in a certain state is 5×10^{-10} m. The uncertainty in its momentum might be:
- A. 5.0×10^{-24} kg · m/s
 - B. 4.0×10^{-24} kg · m/s
 - C. 3.0×10^{-24} kg · m/s
 - D. all of the above
 - E. none of the above
- ans: D
50. The reflection coefficient R for a certain barrier tunneling problem is 0.80. The corresponding transmission coefficient T is:
- A. 0.80
 - B. 0.60
 - C. 0.50
 - D. 0.20
 - E. 0
- ans: D
51. An electron with energy E is incident upon a potential energy barrier of height $E_{\text{pot}} > E$ and thickness L . The transmission coefficient T :
- A. is zero
 - B. decreases exponentially with L
 - C. is proportional to $1/L$
 - D. is proportional to $1/L^2$
 - E. is non-zero and independent of L
- ans: B
52. In order to tunnel through a potential barrier a particle must:
- A. have energy greater than the barrier height
 - B. have spin
 - C. be massive
 - D. have a wavelength longer than the barrier width
 - E. none of the above
- ans: E
53. An electron with energy E is incident on a potential energy barrier of height E_{pot} and thickness L . The probability of tunneling increases if:
- A. E decreases without any other changes
 - B. E_{pot} increases without any other changes
 - C. L decreases without any other changes
 - D. E and E_{pot} increase by the same amount
 - E. E and E_{pot} decrease by the same amount
- ans: C

54. Identical particles, each with energy E , are incident on the following four potential energy barriers:

1. barrier height = $5E$, barrier width = $2L$
2. barrier height = $10E$, barrier width = L
3. barrier height = $17E$, barrier width = $L/2$
4. barrier height = $26E$, barrier width = $L/3$

Rank the barriers in terms of the probability that the particles tunnel through them, from least probability to greatest probability.

- A. 1, 2, 3, 4
- B. 4, 3, 2, 1
- C. 1 and 2 tied, then 3, then 4
- D. 2, then 1 and 3 tied, then 4
- E. 3, 2, 1, 4

ans: A

www.allonlinefree.com

Chapter 39: MORE ABOUT MATTER WAVES

1. If a wave function ψ for a particle moving along the x axis is normalized, then:
 - A. $\int |\psi|^2 dt = 1$
 - B. $\int |\psi|^2 dx = 1$
 - C. $\partial\psi/\partial x = 1$
 - D. $\partial\psi/\partial t = 1$
 - E. $|\psi|^2 = 1$ans: B
2. The energy of a particle in a one-dimensional trap with zero potential energy in the interior and infinite potential energy at the walls is proportional to ($n =$ quantum number):
 - A. n
 - B. $1/n$
 - C. $1/n^2$
 - D. \sqrt{n}
 - E. n^2ans: E
3. The ground state energy of an electron in a one-dimensional trap with zero potential energy in the interior and infinite potential energy at the walls is 2.0 eV. If the width of the well is doubled, the ground state energy will be:
 - A. 0.5 eV
 - B. 1.0 eV
 - C. 2.0 eV
 - D. 4.0 eV
 - E. 8.0 eVans: A
4. An electron is in a one-dimensional trap with zero potential energy in the interior and infinite potential energy at the walls. The ratio E_3/E_1 of the energy for $n = 3$ to that for $n = 1$ is:
 - A. $1/3$
 - B. $1/9$
 - C. $3/1$
 - D. $9/1$
 - E. $1/1$ans: D

5. A particle is trapped in a one-dimensional well with infinite potential energy at the walls. Three possible pairs of energy levels are

1. $n = 3$ and $n = 1$
2. $n = 3$ and $n = 2$
3. $n = 4$ and $n = 3$

Order these pairs according to the difference in energy, least to greatest.

- A. 1, 2, 3
- B. 3, 2, 1
- C. 2, 3, 1
- D. 1, 3, 2
- E. 3, 1, 2

ans: C

6. Identical particles are trapped in one-dimensional wells with infinite potential energy at the walls. The widths L of the traps and the quantum numbers n of the particles are

1. $L = 2L_0$, $n = 2$
2. $L = 2L_0$, $n = 4$
3. $L = 3L_0$, $n = 3$
4. $L = 4L_0$, $n = 2$

Rank them according to the kinetic energies of the particles, least to greatest.

- A. 1, 2, 3, 4
- B. 4, 3, 2, 1
- C. 1 and 3 tied, then 2, 4
- D. 4, 2, then 1 and 3 tied
- E. 1, 3, then 2 and 4 tied

ans: D

7. Four different particles are trapped in one-dimensional wells with infinite potential energy at their walls. The masses of the particles and the width of the wells are

1. mass = $4m_0$, width = $2L_0$
2. mass = $2m_0$, width = $2L_0$
3. mass = $4m_0$, width = L_0
4. mass = m_0 , width = $2L_0$

Rank them according to the kinetic energies of the particles when they are in their ground states.

- A. 1, 2, 3, 4
- B. 1, 2, 3 and 4 tied
- C. 1 and 2 tied, then 3, 4
- D. 4, 3, 2, 1
- E. 3, 1, 2, 4

ans: B

8. The ground state energy of an electron in a one-dimensional trap with zero potential energy in the interior and infinite potential energy at the walls:
- A. is zero
 - B. decreases with temperature
 - C. increases with temperature
 - D. is independent of temperature
 - E. oscillates with time
- ans: D

9. An electron is in a one-dimensional trap with zero potential energy in the interior and infinite potential energy at the walls. A graph of its wave function $\psi(x)$ versus x is shown. The value of quantum number n is:

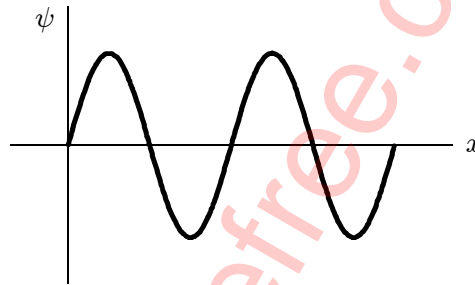

- A. 0
 - B. 2
 - C. 4
 - D. 6
 - E. 8
- ans: C

10. An electron is in a one-dimensional trap with zero potential energy in the interior and infinite potential energy at the walls. A graph of its probability density $P(x)$ versus x is shown. The value of the quantum number n is:

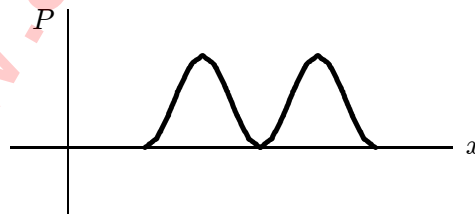

- A. 0
 - B. 1
 - C. 2
 - D. 3
 - E. 4
- ans: C

11. A particle is trapped in an infinite potential energy well. It is in the state with quantum number $n = 14$. How many nodes does the probability density have (counting the nodes at the ends of the well)?
- A. none
 - B. 7
 - C. 13
 - D. 14
 - E. 15

ans: E

12. A particle is trapped in an infinite potential energy well. It is in the state with quantum number $n = 14$. How many maxima does the probability density have?
- A. none
 - B. 7
 - C. 13
 - D. 14
 - E. 15

ans: D

13. A particle is confined to a one-dimensional trap by infinite potential energy walls. Of the following states, designed by the quantum number n , for which one is the probability density greatest near the center of the well?
- A. $n = 2$
 - B. $n = 3$
 - C. $n = 4$
 - D. $n = 5$
 - E. $n = 6$

ans: B

14. Two one-dimensional traps have infinite potential energy at their walls. Trap A has width L and trap B has width $2L$. For which value of the quantum number n does a particle in trap B have the same energy as a particle in the ground state of trap A?
- A. $n = 1$
 - B. $n = 2$
 - C. $n = 3$
 - D. $n = 4$
 - E. $n = 5$

ans: B

15. An electron is trapped in a deep well with a width of 0.3 nm. If it is in the state with quantum number $n = 3$ its kinetic energy is:
- A. 6.0×10^{-28} J
 - B. 1.8×10^{-27} J
 - C. 6.7×10^{-19} J
 - D. 2.0×10^{-18} J
 - E. 6.0×10^{-18} J

ans: E

16. An electron is in a one-dimensional well with finite potential energy barriers at the walls. The matter wave:
- A. is zero at the barriers
 - B. is zero everywhere within each barrier
 - C. is zero in the well
 - D. extends into the barriers
 - E. is discontinuous at the barriers
- ans: D
17. A particle is confined by finite potential energy walls to a one-dimensional trap from $x = 0$ to $x = L$. Its wave function in the region $x > L$ has the form:
- A. $\psi(x) = A \sin(kx)$
 - B. $\psi(x) = Ae^{kx}$
 - C. $\psi(x) = Ae^{-kx}$
 - D. $\psi(x) = Ae^{ikx}$
 - E. $\psi(x) = 0$
- ans: C
18. A particle is trapped in a finite potential energy well that is deep enough so that the electron can be in the state with $n = 4$. For this state how many nodes does the probability density have?
- A. none
 - B. 1
 - C. 3
 - D. 5
 - E. 7
- ans: C
19. A particle in a certain finite potential energy well can have any of five quantized energy values and no more. Which of the following would allow it to have any of six quantized energy levels?
- A. Increase the momentum of the particle
 - B. Decrease the momentum of the particle
 - C. Decrease the well width
 - D. Increase the well depth
 - E. Decrease the well depth
- ans: D
20. A particle in a certain finite potential energy well can have any of five quantized energy values and no more. Which of the following would allow it to have any of six quantized energy levels?
- A. Increase the energy of the particle
 - B. Decrease the energy of the particle
 - C. Make the well shallower
 - D. Make the well deeper
 - E. Make the well narrower
- ans: D

21. An electron in an atom initially has an energy 5.5 eV above the ground state energy. It drops to a state with energy 3.2 eV above the ground state energy and emits a photon in the process. The wave associated with the photon has a wavelength of:
- A. 5.4×10^{-7} m
 - B. 3.0×10^{-7} m
 - C. 1.7×10^{-7} m
 - D. 1.15×10^{-7} m
 - E. 1.0×10^{-7} m
- ans: A
22. An electron in an atom drops from an energy level at -1.1×10^{-18} J to an energy level at -2.4×10^{-18} J. The wave associated with the emitted photon has a frequency of:
- A. 2.0×10^{17} Hz
 - B. 2.0×10^{15} Hz
 - C. 2.0×10^{13} Hz
 - D. 2.0×10^{11} Hz
 - E. 2.0×10^9 Hz
- ans: B
23. An electron in an atom initially has an energy 7.5 eV above the ground state energy. It drops to a state with an energy of 3.2 eV above the ground state energy and emits a photon in the process. The momentum of the photon is:
- A. 1.7×10^{-27} kg · m/s
 - B. 2.3×10^{-27} kg · m/s
 - C. 4.0×10^{-27} kg · m/s
 - D. 5.7×10^{-27} kg · m/s
 - E. 8.0×10^{-27} kg · m/s
- ans: B
24. The quantum number n is most closely associated with what property of the electron in a hydrogen atom?
- A. Energy
 - B. Orbital angular momentum
 - C. Spin angular momentum
 - D. Magnetic moment
 - E. z component of angular momentum
- ans: A
25. Take the potential energy of a hydrogen atom to be zero for infinite separation of the electron and proton. Then, according to quantum theory the energy E_n of a state with principal quantum number n is proportional to:
- A. n
 - B. n^2
 - C. $1/n$
 - D. $1/n^2$
 - E. none of the above
- ans: D

26. The binding energy of an electron in the ground state in a hydrogen atom is about:
- A. 13.6 eV
 - B. 3.4 eV
 - C. 10.2 eV
 - D. 1.0 eV
 - E. 27.2 eV
- ans: A
27. Take the potential energy of a hydrogen atom to be zero for infinite separation of the electron and proton. Then the ground state energy is -13.6 eV. The energy of the first excited state is:
- A. 0
 - B. -3.4 eV
 - C. -6.8 eV
 - D. -9.6 eV
 - E. -27 eV
- ans: B
28. Take the potential energy of a hydrogen atom to be zero for infinite separation of the electron and proton. Then the ground state energy is -13.6 eV. The negative sign indicates:
- A. the kinetic energy is negative
 - B. the potential energy is positive
 - C. the electron might escape from the atom
 - D. the electron and proton are bound together
 - E. none of the above
- ans: D
29. Take the potential energy of a hydrogen atom to be zero for infinite separation of the electron and proton. Then the ground state energy of a hydrogen atom is -13.6 eV. When the electron is in the first excited state its excitation energy is:
- A. 0
 - B. 3.4 eV
 - C. 6.8 eV
 - D. 10.2 eV
 - E. 13.6 eV
- ans: D
30. Take the potential energy of a hydrogen atom to be zero for infinite separation of the electron and proton. Then the ground state energy is -13.6 eV. When the electron is in the first excited state the ionization energy is:
- A. 0
 - B. 3.4 eV
 - C. 6.8 eV
 - D. 10.2 eV
 - E. 13.6 eV
- ans: B

31. The diagram shows the energy levels for an electron in a certain atom. Of the transitions shown, which represents the emission of a photon with the most energy?

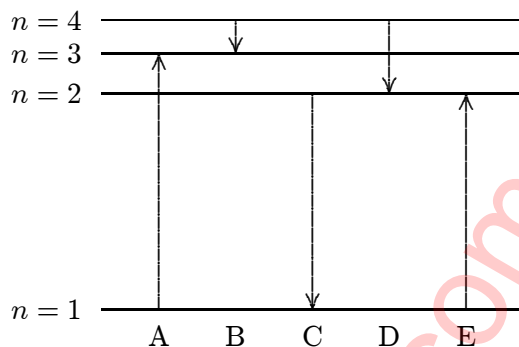

ans: C

32. When a hydrogen atom makes the transition from the second excited state to the ground state (at -13.6 eV) the energy of the photon emitted is:

- A. 0
- B. 1.5 eV
- C. 9.1 eV
- D. 12.1 eV
- E. 13.6 eV

ans: D

33. The series limit for the Balmer series represents a transition $m \rightarrow n$, where (m, n) is

- A. (2, 1)
- B. (3, 2)
- C. (∞ , 0)
- D. (∞ , 1)
- E. (∞ , 2)

ans: E

34. The Balmer series of hydrogen is important because it:

- A. is the only one for which the quantum theory can be used
- B. is the only series that occurs for hydrogen
- C. is in the visible region
- D. involves the lowest possible quantum number n
- E. involves the highest possible quantum number n

ans: C

35. The principle of complementarity is due to:

- A. Einstein
- B. Maxwell
- C. Newton
- D. Bohr
- E. Schrodinger

ans: D

36. Which of the following sets of quantum numbers is possible for an electron in a hydrogen atom?

- A. $n = 4, \ell = 3, m_\ell = -3$
- B. $n = 4, \ell = 4, m_\ell = -2$
- C. $n = 5, \ell = -1, m_\ell = 2$
- D. $n = 3, \ell = 1, m_\ell = -2$
- E. $n = 2, \ell = 3, m_\ell = -2$

ans: A

37. The wave function for an electron in a state with zero angular momentum:

- A. is zero everywhere
- B. is spherically symmetric
- C. depends on the angle from the z axis
- D. depends on the angle from the x axis
- E. is spherically symmetric for some shells and depends on the angle from the z axis for others

ans: B

38. Consider the following:

1. the probability density for an $\ell = 0$ state
2. the probability density for a state with $\ell \neq 0$
3. the average of the probability densities for all states in an $\ell \neq 0$ subshell

Of these which are spherically symmetric?

- A. only 1
- B. only 2
- C. only 1 and 2
- D. only 1 and 3
- E. 1, 2, and 3

ans: D

39. If the wave function ψ is spherically symmetric then the radial probability density is given by:

- A. $4\pi r^2 \psi$
- B. $|\psi|^2$
- C. $4\pi r^2 |\psi|^2$
- D. $4\pi |\psi|^2$
- E. $4\pi r |\psi|^2$

ans: C

40. If $P(r)$ is the radial probability density then the probability that the separation of the electron and proton is between r and $r + dr$ is:

- A. $P dr$
- B. $|P|^2 dr$
- C. $4\pi r^2 P dr$
- D. $4\pi r^2 |P| dr$
- E. $4\pi |P|^2 dr$

ans: A

41. The radial probability density for the electron in the ground state of a hydrogen atom has a peak at about:
- A. 0.5 pm
 - B. 5 pm
 - C. 50 pm
 - D. 500 pm
 - E. 5000 pm
- ans: C

www.allonlinefree.com

Chapter 40: ALL ABOUT ATOMS

- The magnitude of the orbital angular momentum of an electron in an atom is what multiple of \hbar ? (ℓ is a positive integer.)
 - 1
 - $1/2$
 - $\sqrt{\ell(\ell + 1)}$
 - $2\ell + 1$
 - ℓ^2ans: C
- The magnetic quantum number m_ℓ is most closely associated with what property of an electron in an atom?
 - Magnitude of the orbital angular momentum
 - Energy
 - z component of the spin angular momentum
 - z component of the orbital angular momentum
 - Radius of the orbitans: D
- The quantum number m_s is most closely associated with what property of the electron in an atom?
 - Magnitude of the orbital angular momentum
 - Energy
 - z component of the spin angular momentum
 - z component of the orbital angular momentum
 - Radius of the orbitans: C
- Possible values of the principal quantum number n for an electron in an atom are:
 - only 0 and 1
 - only 0, 1, 2, ..., ∞
 - only 0, 1, ..., $\ell - 1$
 - only $1/2$ and $-1/2$
 - only 1, 2, 3, ..., ∞ans: E
- The number of values of the orbital quantum number ℓ associated with the principal quantum number $n = 3$ is:
 - 1
 - 2
 - 3
 - 4
 - 7ans: C

6. The number of possible values of the magnetic quantum number m_ℓ associated with a given value of the orbital quantum number ℓ is:
- A. 1
 - B. 2
 - C. ℓ
 - D. 2ℓ
 - E. $2\ell + 1$
- ans: E
7. An atom is in a state with orbital quantum number $\ell = 2$. Possible values of the magnetic quantum number m_ℓ are:
- A. 1, 2
 - B. 0, 1, 2
 - C. 0, 1
 - D. -1, 0, 1
 - E. -2, -1, 0, 1, 2
- ans: E
8. An electron is in a quantum state for which the magnitude of the orbital angular momentum is $6\sqrt{2}\hbar$. How many allowed values of the z component of the angular momentum are there?
- A. 4
 - B. 5
 - C. 7
 - D. 8
 - E. 9
- ans: D
9. An electron is in a quantum state for which there are seven allowed values of the z component of the angular momentum. The magnitude of the angular momentum is:
- A. $\sqrt{3}\hbar$
 - B. $\sqrt{7}\hbar$
 - C. $\sqrt{9}\hbar$
 - D. $\sqrt{12}\hbar$
 - E. $\sqrt{14}\hbar$
- ans: D
10. The number of states in a subshell with orbital quantum number $\ell = 3$ is:
- A. 2
 - B. 3
 - C. 7
 - D. 9
 - E. 14
- ans: E

11. The number of states in a shell with principal quantum number $n = 3$ is:
- A. 3
 - B. 9
 - C. 15
 - D. 18
 - E. 25
- ans: D
12. An electron in an atom is in a state with principal quantum number $n = 4$. The possible values of the orbital quantum number ℓ are:
- A. 1, 2, 3
 - B. 1, 2, 3, 4
 - C. -3, -2, -1, 0, 1, 2, 3
 - D. 0, 1, 2, 3
 - E. 0, 1, 2
- ans: D
13. Space quantization means that:
- A. space is quantized
 - B. L_z can have only certain discrete values
 - C. \vec{L} and $\vec{\mu}$ are in the same direction
 - D. \vec{L} and $\vec{\mu}$ are in opposite directions
 - E. an electron has a magnetic dipole moment
- ans: B
14. An electron in an atom is in a state with $\ell = 3$ and $m_\ell = 2$. The angle between \vec{L} and the z axis is:
- A. 48.2°
 - B. 60°
 - C. 30°
 - D. 35.3°
 - E. 54.7°
- ans: E
15. An electron in an atom is in a state with $\ell = 5$. The minimum angle between \vec{L} and the z axis is:
- A. 0°
 - B. 18.0°
 - C. 24.1°
 - D. 36.7°
 - E. 33.6°
- ans: C

16. In the relation $\mu_z = -m_\ell \mu_B$, the quantity μ_B is:
- A. the Bohr magneton
 - B. the component of the dipole moment along the magnetic field
 - C. the permeability of the material
 - D. a friction coefficient
 - E. none of the above
- ans: A
17. The electron states that constitute a single shell for an atom all have:
- A. the same value of n
 - B. the same value of ℓ
 - C. the same value of n and the same value of ℓ
 - D. the same value of ℓ and the same value of m_ℓ
 - E. the same set of all four quantum numbers
- ans: A
18. The electron states that constitute a single subshell for an atom all have:
- A. only the same value of n
 - B. only the same value of ℓ
 - C. only the same value of n and the same value of ℓ
 - D. only the same value of ℓ and the same value of m_ℓ
 - E. the same set of all four quantum numbers
- ans: C
19. The total number of electron states with $n = 2$ and $\ell = 1$ for an atom is:
- A. two
 - B. four
 - C. six
 - D. eight
 - E. ten
- ans: C
20. The possible values for the magnetic quantum number m_s of an electron in an atom:
- A. depend on n
 - B. depend on ℓ
 - C. depend on both n and ℓ
 - D. depend on whether there is an external magnetic field present
 - E. are $\pm 1/2$
- ans: E
21. The Stern-Gerlach experiment makes use of:
- A. a strong uniform magnetic field
 - B. a strong non-uniform magnetic field
 - C. a strong uniform electric field
 - D. a strong non-uniform electric field
 - E. strong perpendicular electric and magnetic fields
- ans: B

22. The magnetic field \vec{B} is along the z axis in a Stern-Gerlach experiment. The force it exerts on a magnetic dipole with dipole moment $\vec{\mu}$ is proportional to:
- μ_z^2
 - B^2
 - dB/dz
 - d^2B/dz^2
 - $\int B dz$
- ans: C
23. A magnetic dipole $\vec{\mu}$ is placed in a strong uniform magnetic field \vec{B} . The associated force exerted on the dipole is:
- along $\vec{\mu}$
 - along $-\vec{\mu}$
 - along \vec{B}
 - along $\vec{\mu} \times \vec{B}$
 - zero
- ans: E
24. The force exerted on a magnetic dipole as it moves with velocity \vec{v} through a Stern-Gerlach apparatus is:
- proportional to v
 - proportional to $1/v$
 - zero
 - proportional to v^2
 - independent of v
- ans: E
25. A magnetic dipole is placed between the poles of a magnet as shown. The direction of the associated force exerted on the dipole is:

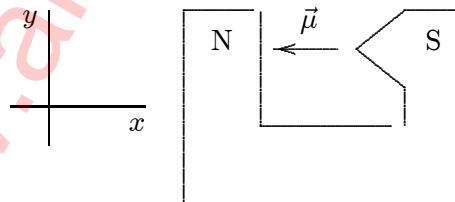

- positive x
 - positive y
 - negative x
 - negative y
 - into or out of the page
- ans: C

26. To observe the Zeeman effect one uses:
- A. a strong uniform magnetic field
 - B. a strong non-uniform magnetic field
 - C. a strong uniform electric field
 - D. a strong non-uniform electric field
 - E. mutually perpendicular electric and magnetic fields
- ans: B
27. An electron in a K shell of an atom has the principal quantum number:
- A. $n = 0$
 - B. $n = 1$
 - C. $n = 2$
 - D. $n = 3$
 - E. $n = \infty$
- ans: B
28. An electron in an L shell of an atom has the principal quantum number:
- A. $n = 0$
 - B. $n = 1$
 - C. $n = 2$
 - D. $n = 3$
 - E. $n = \infty$
- ans: C
29. The most energetic photon in a continuous x-ray spectrum has an energy approximately equal to:
- A. the energy of all the electrons in a target atom
 - B. the kinetic energy of an incident-beam electron
 - C. the rest energy, mc^2 , of an electron
 - D. the total energy of a K-electron in the target atom
 - E. the kinetic energy of a K-electron in the target atom
- ans: B
30. Two different electron beams are incident on two different targets and both produce x rays. The cutoff wavelength for target 1 is shorter than the cutoff wavelength for target 2. We can conclude that:
- A. target 2 has a higher atomic number than target 1
 - B. target 2 has a lower atomic number than target 1
 - C. the electrons in beam 1 have greater kinetic energy than those in beam 2
 - D. the electrons in beam 1 have less kinetic energy than those in beam 2
 - E. target 1 is thicker than target 2
- ans: C

31. A photon with the smallest wavelength in the continuous z-ray spectrum is emitted when:
- A. an electron is knocked from a K shell
 - B. a valence electron is knocked from the atom
 - C. the incident electron becomes bound to the atom
 - D. the atom has the greatest recoil energy
 - E. the incident electron loses all its energy in a single decelerating event
- ans: E
32. Radiation with the minimum wavelength as well as the K x-ray lines are detected for a certain target. The energy of the incident electrons is then doubled, with the result that
- A. the minimum wavelength increases and the wavelengths of the K lines remain the same
 - B. the minimum wavelength decreases and the wavelengths of the K lines remain the same
 - C. the minimum wavelength and the wavelengths of the K lines all increase
 - D. the minimum wavelength and the wavelengths of the K lines all decrease
 - E. the minimum wavelength increases and the wavelengths of the K lines all decrease
- ans: B
33. Characteristic K x-radiation of an element occurs when:
- A. the incident electron is absorbed by a target nucleus
 - B. the incident electron is scattered by a target atom without an energy loss
 - C. an electron is ejected from an outer shell of a target atom
 - D. an electron in a target atom makes a transition to the lowest energy state
 - E. the incident electron goes into the lowest energy state
- ans: D
34. The K_{α} x rays arising from a cobalt ($Z = 27$) target have a wavelength of about 179 pm. The atomic number of a target that gives rise to K_{α} x rays with a wavelength one-third as great (≈ 60 pm) is:
- A. $Z = 9$
 - B. $Z = 10$
 - C. $Z = 12$
 - D. $Z = 16$
 - E. $Z = 46$
- ans: E
35. In connection with x-ray emission the symbol K_{α} refers to:
- A. an alpha particle radiation
 - B. an effect of the dielectric constant on energy levels
 - C. x-ray radiation from potassium
 - D. x-ray radiation associated with an electron going from $n = \infty$ to $n = 1$
 - E. x-ray radiation associated with an electron going from $n = 2$ to $n = 1$
- ans: E

36. In connection with x-ray emission the symbol L_β refers to:
- a beta particle radiation
 - an atomic state of angular momentum $h/2\pi$
 - the inductance associated with an orbiting electron
 - x-radiation associated with an electron going from $n = 4$ to $n = 2$
 - none of the above
- ans: D

37. The transition shown gives rise to an x-ray. The correct label for this is:

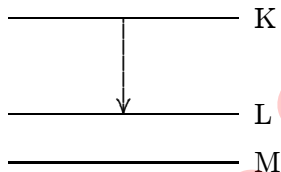

- K_α
 - K_β
 - L_α
 - L_β
 - KL
- ans: A
38. In a Moseley graph:
- the x-ray frequency is plotted as a function of atomic number
 - the square of the x-ray frequency is plotted as a function of atomic number
 - the square root of the x-ray frequency is plotted as a function of atomic number
 - the x-ray frequency is plotted as a function of the square root of atomic number
 - the square root of the x-ray frequency is plotted as a function of atomic mass
- ans: C
39. In calculating the x-ray energy levels the effective charge of the nucleus is taken to be $Z - b$, where Z is the atomic number. The parameter b enters because:
- an electron is removed from the inner shell
 - a proton is removed from the nucleus
 - the quantum mechanical force between two charges is less than the classical force
 - the nucleus is screened by electrons
 - the Pauli exclusion principle must be obeyed
- ans: D
40. The ratio of the wavelength of the K_α x-ray line for Nb ($Z = 41$) to that of Ga ($Z = 31$) is:
- 9/16
 - 16/9
 - 3/4
 - 4/3
 - 1.15
- ans: A

41. The Pauli exclusion principle is obeyed by:
- A. all particles
 - B. all charged particles
 - C. all particles with spin quantum numbers of $1/2$
 - D. all particles with spin quantum numbers of 1
 - E. all particles with mass
- ans: C
42. No state in an atom can be occupied by more than one electron. This is most closely related to:
- A. the wave nature of matter
 - B. the finite value for the speed of light
 - C. the Bohr magneton
 - D. the Pauli exclusion principle
 - E. the Einstein-de Haas effect
- ans: D
43. Electrons are in a two-dimensional square potential energy well with sides of length L . The potential energy is infinite at the sides and zero inside. The single-particle energies are given by $(h^2/8mL^2)(n_x^2 + n_y^2)$, where n_x and n_y are integers. At most the number of electrons that can have energy $8(h^2/8mL^2)$ is:
- A. 1
 - B. 2
 - C. 3
 - D. 4
 - E. any number
- ans: B
44. Five electrons are in a two-dimensional square potential energy well with sides of length L . The potential energy is infinite at the sides and zero inside. The single-particle energies are given by $(h^2/8mL^2)(n_x^2 + n_y^2)$, where n_x and n_y are integers. In units of $(h^2/8mL^2)$ the energy of the ground state of the system is:
- A. 0
 - B. 10
 - C. 19
 - D. 24
 - E. 48
- ans: C

45. Five electrons are in a two-dimensional square potential energy well with sides of length L . The potential energy is infinite at the sides and zero inside. The single-particle energies are given by $(h^2/8mL^2)(n_x^2 + n_y^2)$, where n_x and n_y are integers. In units of $(h^2/8mL^2)$ the energy of the first excited state of the system is:
- A. 13
 - B. 22
 - C. 24
 - D. 25
 - E. 27

ans: B

46. Electrons are in a two-dimensional square potential energy well with sides of length L . The potential energy is infinite at the sides and zero inside. The single-particle energies are given by $(h^2/8mL^2)(n_x^2 + n_y^2)$, where n_x and n_y are integers. The number of single-particle states with energy $5(h^2/8mL^2)$ is:
- A. 1
 - B. 2
 - C. 3
 - D. 4
 - E. 5

ans: B

47. Six electrons are in a two-dimensional square potential energy well with sides of length L . The potential energy is infinite at the sides and zero inside. The single-particle energies are given by $(h^2/8mL^2)(n_x^2 + n_y^2)$, where n_x and n_y are integers. If a seventh electron is added to the system when it is in its ground state the least energy the additional electron can have is:
- A. $2(h^2/8mL^2)$
 - B. $5(h^2/8mL^2)$
 - C. $10(h^2/8mL^2)$
 - D. $13(h^2/8mL^2)$
 - E. $18(h^2/8mL^2)$

ans: C

48. When a lithium atom is made from a helium atom by adding a proton (and neutron) to the nucleus and an electron outside, the electron goes into an $n = 2, \ell = 0$ state rather than an $n = 1, \ell = 0$ state. This is an indication that electrons:
- A. obey the Pauli exclusion principle
 - B. obey the minimum energy principle
 - C. undergo the Zeeman effect
 - D. are diffracted
 - E. and protons are interchangeable

ans: A

49. When a lithium atom in its ground state is made from a helium atom by adding a proton (and neutron) to the nucleus and an electron outside, the electron goes into an $n = 2, \ell = 0$ state rather than an $n = 3, \ell = 0$ state. This is an indication that electrons:
- A. obey the Pauli exclusion principle
 - B. obey the minimum energy principle
 - C. undergo the Zeeman effect
 - D. are diffracted
 - E. and protons are interchangeable

ans: B

50. If electrons did not have intrinsic angular momentum (spin) but still obeyed the Pauli exclusion principle, the states occupied by electrons in the ground state of helium would be:
- A. $(n = 1, \ell = 0); (n = 1, \ell = 0)$
 - B. $(n = 1, \ell = 0); (n = 1, \ell = 1)$
 - C. $(n = 1, \ell = 0); (n = 2, \ell = 0)$
 - D. $(n = 2, \ell = 0); (n = 2, \ell = 1)$
 - E. $(n = 2, \ell = 1); (n = 2, \ell = 1)$

ans: C

51. The minimum energy principle tells us that:
- A. the energy of an atom with a high atomic number is less than the energy of an atom with a low atomic number
 - B. the energy of an atom with a low atomic number is less than the energy of an atom with a high atomic number
 - C. when an atom makes an upward transition the energy of the absorbed photon is the least possible
 - D. the ground state configuration of any atom is the one with the least energy
 - E. the ground state configuration of any atom is the one with the least ionization energy

ans: D

52. Which of the following (n, ℓ, m_ℓ, m_s) combinations is impossible for an electron in an atom?

- A. 3, 1, 1, $-1/2$
- B. 6, 2, 0, $1/2$
- C. 3, 2, $-2, -1/2$
- D. 3, 1, $-2, 1/2$
- E. 1, 0, 0, $-1/2$

ans: D

53. Which of the following subshells cannot exist?

- A. 3p
- B. 2p
- C. 4d
- D. 3d
- E. 2d

ans: E

54. For any atom other than hydrogen and helium all electrons in the same shell have:
- A. the same energy
 - B. the same magnitude of angular momentum
 - C. the same magnetic quantum number
 - D. the same spin quantum number
 - E. none of the above
- ans: E
55. The states being filled from the beginning to end of the lanthanide series of atoms are:
- A. $n = 3, l = 2$ states
 - B. $n = 4, l = 1$ states
 - C. $n = 4, l = 2$ states
 - D. $n = 4, l = 3$ states
 - E. $n = 5, l = 2$ states
- ans: D
56. The most energetic electron in any atom at the beginning of a period of the periodic table is in:
- A. an $l = 0$ state
 - B. an $l = 1$ state
 - C. an $l = 2$ state
 - D. an $n = 0$ state with unspecified angular momentum
 - E. an $n = 1$ state with unspecified angular momentum
- ans: A
57. The most energetic electron in any atom at the end of a period of the periodic table is in:
- A. an $l = 0$ state
 - B. an $l = 1$ state
 - C. an $l = 2$ state
 - D. an $n = 0$ state with unspecified angular momentum
 - E. an $n = 1$ state with unspecified angular momentum
- ans: B
58. The group of atoms at the ends of periods of the periodic table are called:
- A. alkali metals
 - B. rare earths
 - C. transition metal atoms
 - D. alkaline atoms
 - E. inert gas atoms
- ans: E

59. The group of atoms at the beginning of periods of the periodic table are called:
- A. alkali metal atoms
 - B. rare earth atoms
 - C. transition metal atoms
 - D. alkaline atoms
 - E. inert gas atoms
- ans: A
60. Suppose the energy required to ionize an argon atom is i , the energy to excite it is e , and its thermal energy at room temperature is t . In increasing order, these three energies are:
- A. i, e, t
 - B. t, i, e
 - C. e, t, i
 - D. i, t, e
 - E. t, e, i
- ans: C
61. The ionization energy of an atom in its ground state is:
- A. the energy required to remove the least energetic electron
 - B. the energy required to remove the most energetic electron
 - C. the energy difference between the most energetic electron and the least energetic electron
 - D. the same as the energy of a K_{α} photon
 - E. the same as the excitation energy of the most energetic electron
- ans: B
62. The effective charge acting on a single valence electron outside a closed shell is about Ne , where N is:
- A. the atomic number of the nucleus
 - B. the atomic mass of the atom
 - C. usually between 1 and 3
 - D. half the atomic number
 - E. less than 1
- ans: C
63. In a laser:
- A. excited atoms are stimulated to emit photons by radiation external to the laser
 - B. the transitions for laser emission are directly to the ground state
 - C. the states which give rise to laser emission are usually very unstable states that decay rapidly
 - D. the state in which an atom is initially excited is never between two states that are involved in the stimulated emission
 - E. a minimum of two energy levels are required.
- ans: D

64. Photons in a laser beam have the same energy, wavelength, polarization direction, and phase because:
- A. each is produced in an emission that is stimulated by another
 - B. all come from the same atom
 - C. the lasing material has only two quantum states
 - D. all photons are alike, no matter what their source
 - E. none of the above
- ans: A
65. A laser must be pumped to achieve:
- A. a metastable state
 - B. fast response
 - C. stimulated emission
 - D. population inversion
 - E. the same wavelength for all photons
- ans: D
66. Photons in a laser beam are produced by:
- A. transitions from a metastable state
 - B. transitions to a metastable state
 - C. transitions from a state that decays rapidly
 - D. splitting of other photons
 - E. pumping
- ans: A
67. Which of the following is essential for laser action to occur between two energy levels of an atom?
- A. the lower level is metastable
 - B. the upper level is metastable
 - C. the lower level is the ground state
 - D. there are more atoms in the lower level than in the upper level
 - E. the lasing material is a gas
- ans: B
68. Which of the following is essential for laser action to occur between two energy levels of an atom?
- A. the lower level is metastable
 - B. there are more atoms the upper level than in the lower level
 - C. there are more atoms in the lower level than in the upper level
 - D. the lower level is the ground state
 - E. the lasing material is a gas
- ans: B

69. Population inversion is important for the generation of a laser beam because it assures that:
- A. spontaneous emission does not occur more often than stimulated emission
 - B. photons do not split too rapidly
 - C. more photons are emitted than are absorbed
 - D. photons do not collide with each other
 - E. photons do not make upward transitions
- ans: C
70. A metastable state is important for the generation of a laser beam because it assures that:
- A. spontaneous emission does not occur more often than stimulated emission
 - B. photons do not split too rapidly
 - C. more photons are emitted than are absorbed
 - D. photons do not collide with each other
 - E. photons do not make upward transitions
- ans: A
71. Electrons in a certain laser make transitions from a metastable state to the ground state. Initially there are 6×10^{20} atoms in the metastable state and 2×10^{20} atoms in the ground state. The number of photons that can be produced in a single burst is about:
- A. 2×10^{20}
 - B. 3×10^{20}
 - C. 4×10^{20}
 - D. 6×10^{20}
 - E. 8×10^{20}
- ans: C
72. In a helium-neon laser, the laser light arises from a transition from a _____ state to a _____ state.
- A. He, He
 - B. Ne, Ne
 - C. He, Ne
 - D. Ne, He
 - E. N, He
- ans: B
73. The purpose of the mirrors at the ends of a helium-neon laser is:
- A. to assure that no laser light leaks out
 - B. to increase the number of stimulated emissions
 - C. to absorb some of the photons
 - D. to keep the light used for pumping inside the laser
 - E. to double the effective length of the laser
- ans: B

74. A group of electromagnetic waves might
- I. be monochromatic
 - II. be coherent
 - III. have the same polarization direction
- Which of these describe the waves from a laser?
- A. I only
 - B. II only
 - C. III only
 - D. I and II only
 - E. I, II, and III
- ans: E

75. A laser beam can be sharply focused because it is:
- A. highly coherent
 - B. plane polarized
 - C. intense
 - D. circularly polarized
 - E. highly directional
- ans: E

76. The “e” in laser stands for:
- A. electric
 - B. emf
 - C. energy
 - D. emission
 - E. entropy
- ans: D

www.allonlinefree.com

Chapter 41: CONDUCTION OF ELECTRICITY IN SOLIDS

- In a pure metal the collisions that are characterized by the mean free time τ in the expression for the resistivity are chiefly between:
 - electrons and other electrons
 - electrons with energy about equal to the Fermi energy and atoms
 - all electrons and atoms
 - electrons with energy much less than the Fermi energy and atoms
 - atoms and other atomsans: B
- A certain metal has 5.3×10^{29} conduction electrons/m³ and an electrical resistivity of $1.9 \times 10^{-9} \Omega \cdot \text{m}$. The average time between collisions of electrons with atoms in the metal is:
 - 5.6×10^{-33} s
 - 1.3×10^{-31} s
 - 9.9×10^{-22} s
 - 4.6×10^{-15} s
 - 3.5×10^{-14} sans: C
- Which one of the following statements concerning electron energy bands in solids is true?
 - The bands occur as a direct consequence of the Fermi-Dirac occupancy probability function
 - Electrical conduction arises from the motion of electrons in completely filled bands
 - Within a given band, all electron energy levels are equal to each other
 - An insulator has a large energy separation between the highest filled band and the lowest empty band
 - Only insulators have energy bandsans: D
- If E_0 and E_T are the average energies of the “free” electrons in a metal at 0K and room temperature, respectively, then the ratio E_T/E_0 is approximately:
 - 0
 - 1
 - 100
 - 10^6
 - infinityans: B
- The energy gap (in eV) between the valence and conduction bands of an insulator is of the order of:
 - 10^{-19}
 - 0.001
 - 0.1
 - 10
 - 1000ans: D

6. The energy level diagram shown applies to:

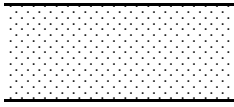

- A. a conductor
- B. an insulator
- C. a semiconductor
- D. an isolated molecule
- E. an isolated atom

ans: A

7. The energy level diagram shown applies to:

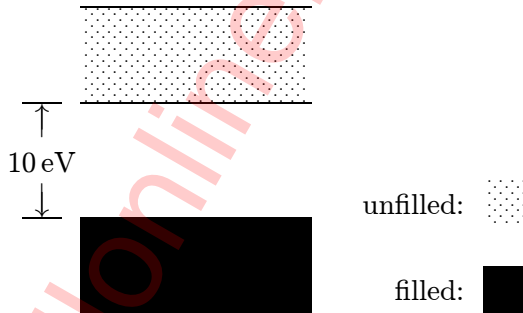

- A. a conductor
- B. an insulator
- C. a semiconductor
- D. an isolated atom
- E. a free-electron gas

ans: B

8. The energy level diagram shown applies to:

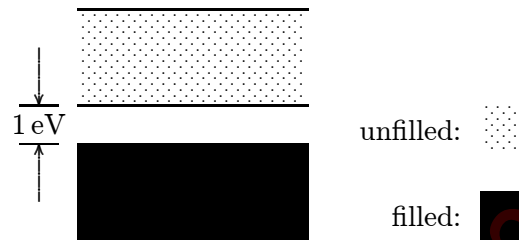

- A. a conductor
- B. an insulator
- C. a semiconductor
- D. an isolated molecule
- E. an isolated atom

ans: C

9. Possible units for the density of states function $N(E)$ are:

- A. J/m^3
- B. $1/\text{J}$
- C. m^{-3}
- D. $\text{J}^{-1}\cdot\text{m}^{-3}$
- E. kg/m^3

ans: D

10. The density of states for a metal depends primarily on:

- A. the temperature
- B. the energy
- C. the density of the metal
- D. the volume of the sample
- E. none of these

ans: B

11. The Fermi-Dirac occupancy probability $P(E)$ varies between:

- A. 0 and 1
- B. 0 and infinity
- C. 1 and infinity
- D. -1 and 1
- E. 0 and E_F

ans: A

12. For a metal at absolute temperature T , with Fermi energy E_F , the occupancy probability is given by:
- A. $e^{(E-E_F)/kT}$
 - B. $e^{-(E-E_F)/kT}$
 - C. $\frac{1}{e^{(E-E_F)/kT} + 1}$
 - D. $\frac{1}{e^{-(E-E_F)/kT} + 1}$
 - E. $\frac{1}{e^{(E-E_F)/kT} - 1}$
- ans: C
13. In a metal at 0 K, the Fermi energy is:
- A. the highest energy of any electron
 - B. the lowest energy of any electron
 - C. the mean thermal energy of the electrons
 - D. the energy of the top of the valence band
 - E. the energy at the bottom of the conduction band
- ans: A
14. The occupancy probability for a state with energy equal to the Fermi energy is:
- A. 0
 - B. 0.5
 - C. 1
 - D. 1.5
 - E. 2
- ans: B
15. The Fermi energy of a metal depends primarily on:
- A. the temperature
 - B. the volume of the sample
 - C. the mass density of the metal
 - D. the size of the sample
 - E. the number density of conduction electrons
- ans: E
16. The speed of an electron with energy equal to the Fermi energy for copper is on the order of:
- A. 10^6 m/s
 - B. 10^{-6} m/s
 - C. 10 m/s
 - D. 10^{-1} m/s
 - E. 10^9 m/s
- ans: A

17. At $T = 0\text{ K}$ the probability that a state 0.50 eV below the Fermi level is occupied is about:
- A. 0
 - B. 5.0×10^{-9}
 - C. 5.0×10^{-6}
 - D. 5.0×10^{-3}
 - E. 1
- ans: E
18. At $T = 0\text{ K}$ the probability that a state 0.50 eV above the Fermi level is occupied is about:
- A. 0
 - B. 5.0×10^{-9}
 - C. 5.0×10^{-6}
 - D. 5.0×10^{-3}
 - E. 1
- ans: A
19. At room temperature kT is about 0.0259 eV . The probability that a state 0.50 eV above the Fermi level is occupied at room temperature is:
- A. 1
 - B. 0.05
 - C. 0.025
 - D. 5.0×10^{-6}
 - E. 4.1×10^{-9}
- ans: E
20. At room temperature kT is about 0.0259 eV . The probability that a state 0.50 eV below the Fermi level is unoccupied at room temperature is:
- A. 1
 - B. 0.05
 - C. 0.025
 - D. 5.0×10^{-6}
 - E. 4.1×10^{-9}
- ans: E
21. If the density of states is $N(E)$ and the occupancy probability is $P(E)$, then the density of occupied states is:
- A. $N(E) + P(E)$
 - B. $N(E)/P(E)$
 - C. $N(E) - P(E)$
 - D. $N(E)P(E)$
 - E. $P(E)/N(E)$
- ans: D

22. A hole refers to:
- a proton
 - a positively charged electron
 - an electron that has somehow lost its charge
 - a microscopic defect in a solid
 - the absence of an electron in an otherwise filled band
- ans: E
23. Electrons in a full band do not contribute to the current when an electric field exists in a solid because:
- the field cannot exert a force on them
 - the individual contributions cancel each other
 - they are not moving
 - they make transitions to other bands
 - they leave the solid
- ans: B
24. For a pure semiconductor the Fermi level is:
- in the conduction band
 - well above the conduction band
 - in the valence band
 - well below the valence band
 - near the center of the gap between the valence and conduction bands
- ans: E
25. The number density n of conduction electrons, the resistivity ρ , and the temperature coefficient of resistivity α are given below for five materials. Which is a semiconductor?
- $n = 10^{29} \text{ m}^{-3}$, $\rho = 10^{-8} \Omega \cdot \text{m}$, $\alpha = +10^{-3} \text{ K}^{-1}$
 - $n = 10^{28} \text{ m}^{-3}$, $\rho = 10^{-9} \Omega \cdot \text{m}$, $\alpha = -10^{-3} \text{ K}^{-1}$
 - $n = 10^{28} \text{ m}^{-3}$, $\rho = 10^{-9} \Omega \cdot \text{m}$, $\alpha = +10^{-3} \text{ K}^{-1}$
 - $n = 10^{15} \text{ m}^{-3}$, $\rho = 10^3 \Omega \cdot \text{m}$, $\alpha = -10^{-2} \text{ K}^{-1}$
 - $n = 10^{15} \text{ m}^{-3}$, $\rho = 10^{-7} \Omega \cdot \text{m}$, $\alpha = +10^{-3} \text{ K}^{-1}$
- ans: D
26. A pure semiconductor at room temperature has:
- more electrons/ m^3 in its conduction band than holes/ m^3 in its valence band
 - more electrons/ m^3 in its conduction band than a typical metal
 - more electrons/ m^3 in its valence band than at $T = 0 \text{ K}$
 - more holes/ m^3 in its valence band than electrons/ m^3 in its valence band
 - none of the above
- ans: E

27. For a metal at room temperature the temperature coefficient of resistivity is determined primarily by:
- A. the number of electrons in the conduction band
 - B. the number of impurity atoms
 - C. the binding energy of outer shell electrons
 - D. collisions between conduction electrons and atoms
 - E. none of the above
- ans: D
28. For a pure semiconductor at room temperature the temperature coefficient of resistivity is determined primarily by:
- A. the number of electrons in the conduction band
 - B. the number of replacement atoms
 - C. the binding energy of outer shell electrons
 - D. collisions between conduction electrons and atoms
 - E. none of the above
- ans: A
29. A certain material has a resistivity of $7.8 \times 10^3 \Omega \cdot \text{m}$ at room temperature and it increases as the temperature is raised by 100°C . The material is most likely:
- A. a metal
 - B. a pure semiconductor
 - C. a heavily doped semiconductor
 - D. an insulator
 - E. none of the above
- ans: C
30. A certain material has a resistivity of $7.8 \times 10^3 \Omega \cdot \text{m}$ at room temperature and it decreases as the temperature is raised by 100°C . The material is most likely:
- A. a metal
 - B. a pure semiconductor
 - C. a heavily doped semiconductor
 - D. an insulator
 - E. none of the above
- ans: B
31. A certain material has a resistivity of $7.8 \times 10^{-8} \Omega \cdot \text{m}$ at room temperature and it increases as the temperature is raised by 100°C . The material is most likely:
- A. a metal
 - B. a pure semiconductor
 - C. a heavily doped semiconductor
 - D. an insulator
 - E. none of the above
- ans: A

32. Donor atoms introduced into a pure semiconductor at room temperature:
- A. increase the number of electrons in the conduction band
 - B. increase the number of holes in the valence band
 - C. lower the Fermi level
 - D. increase the electrical resistivity
 - E. none of the above
- ans: A
33. Acceptor atoms introduced into a pure semiconductor at room temperature:
- A. increase the number of electrons in the conduction band
 - B. increase the number of holes in the valence band
 - C. raise the Fermi level
 - D. increase the electrical resistivity
 - E. none of the above
- ans: B
34. An acceptor replacement atom in silicon might have _____ electrons in its outer shell.
- A. 3
 - B. 4
 - C. 5
 - D. 6
 - E. 7
- ans: A
35. A donor replacement atom in silicon might have _____ electrons in its outer shell.
- A. 1
 - B. 2
 - C. 3
 - D. 4
 - E. 5
- ans: E
36. A given doped semiconductor can be identified as *p* or *n* type by:
- A. measuring its electrical conductivity
 - B. measuring its magnetic susceptibility
 - C. measuring its coefficient of resistivity
 - D. measuring its heat capacity
 - E. performing a Hall effect experiment
- ans: E
37. The contact electric field in the depletion region of a *p-n* junction is produced by:
- A. electrons in the conduction band alone
 - B. holes in the valence band alone
 - C. electrons and holes together
 - D. charged replacement atoms
 - E. an applied bias potential difference
- ans: D

38. For an unbiased p - n junction, the energy at the bottom of the conduction band on the n side is:
- A. higher than the energy at the bottom of the conduction band on the p side
 - B. lower than the energy at the bottom of the conduction band on the p side
 - C. lower than the energy at the top of the valence band on the n side
 - D. lower than the energy at the top of the valence band on the p side
 - E. the same as the energy at the bottom of the conduction band on the p side
- ans: B
39. In an unbiased p - n junction:
- A. the electric potential vanishes everywhere
 - B. the electric field vanishes everywhere
 - C. the drift current vanishes everywhere
 - D. the diffusion current vanishes everywhere
 - E. the diffusion and drift currents cancel each other
- ans: E
40. Application of a forward bias to a p - n junction:
- A. narrows the depletion zone
 - B. increases the electric field in the depletion zone
 - C. increases the potential difference across the depletion zone
 - D. increases the number of donors on the n side
 - E. decreases the number of donors on the n side
- ans: A
41. Application of a forward bias to a p - n junction:
- A. increases the drift current in the depletion zone
 - B. increases the diffusion current in the depletion zone
 - C. decreases the drift current on the p side outside the depletion zone
 - D. decreases the drift current on the n side outside the depletion zone
 - E. does not change the current anywhere
- ans: B
42. When a forward bias is applied to a p - n junction the concentration of electrons on the p side:
- A. increases slightly
 - B. increases dramatically
 - C. decreases slightly
 - D. decreases dramatically
 - E. does not change
- ans: B

43. Which of the following is NOT true when a back bias is applied to a $p-n$ junction?
- A. Electrons flow from the p to the n side
 - B. Holes flow from the p to the n side
 - C. The electric field in the depletion zone increases
 - D. The potential difference across the depletion zone increases
 - E. The depletion zone narrows

ans: B

44. Switch S is closed to apply a potential difference V across a $p-n$ junction as shown. Relative to the energy levels of the n -type material, with the switch open, the electron levels of the p -type material are:

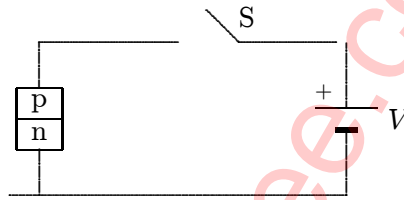

- A. unchanged
- B. lowered by the amount $e^{-Ve/kT}$
- C. lowered by the amount Ve
- D. raised by the amount $e^{-Ve/kT}$
- E. raised by the amount Ve

ans: C

45. A sinusoidal potential difference $V_{in} = V_m \sin(\omega t)$ is applied to the $p-n$ junction as shown. Which graph correctly shows V_{out} as a function of time?

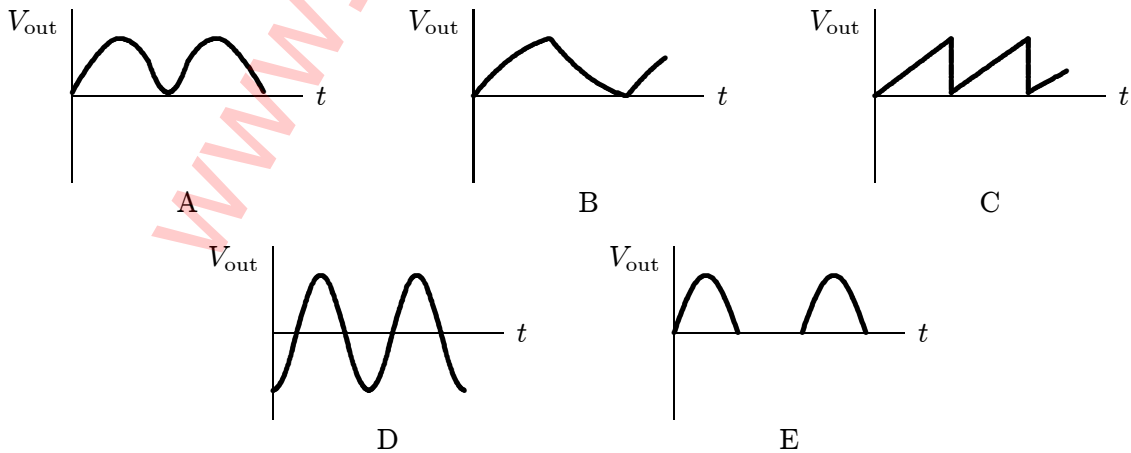
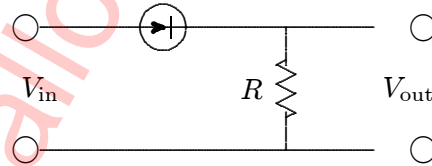

ans: E

46. In normal operation the current in a MOSFIT device is controlled by changing:
- A. the number of donors and acceptors
 - B. the width of the depletion zone
 - C. the size of the sample
 - D. the density of electron states
 - E. the temperature
- ans: B
47. "LED" stands for:
- A. Less Energy Donated
 - B. Light Energy Degraded
 - C. Luminescent Energy Developer
 - D. Laser Energy Detonator
 - E. none of the above
- ans: E
48. A light emitting diode emits light when:
- A. electrons are excited from the valence to the conduction band
 - B. electrons from the conduction band recombine with holes from the valence band
 - C. electrons collide with atoms
 - D. electrons are accelerated by the electric field in the depletion region
 - E. the junction gets hot
- ans: B
49. The gap between the valence and conduction bands of a certain semiconductor is 0.85 eV. When this semiconductor is used to form a light emitting diode, the wavelength of the light emitted:
- A. is in a range above 1.5×10^{-6} m
 - B. is in a range below 1.5×10^{-6} m
 - C. is always 1.5×10^{-6} m
 - D. is in a range centered on 1.5×10^{-6} m
 - E. has nothing to do with the gap
- ans: B

Chapter 42: NUCLEAR PHYSICS

1. The smallest particle of any chemical element that can exist by itself and yet retain the qualities that distinguish it as that element is:
 - A. an electron
 - B. a proton
 - C. a neutron
 - D. an atom
 - E. a moleculeans: D
2. Of the following, which has the smallest rest energy?
 - A. A neutron
 - B. An electron
 - C. An ion
 - D. A proton
 - E. An atomans: B
3. The mass of an electron:
 - A. is almost the same as that of a neutron
 - B. is negative
 - C. equals that of a proton
 - D. is zero if the electron is at rest
 - E. is much less than that of a protonans: E
4. The mass of a neutron:
 - A. equals that of an electron
 - B. equals that of a proton
 - C. is a little more than that of a proton
 - D. is exactly that of a proton plus an electron
 - E. is as yet unmeasuredans: C
5. The mass of a hydrogen atom, in kilograms, is approximately:
 - A. 10^{-27}
 - B. 10^{-31}
 - C. 10^{-24}
 - D. 10^{-13}
 - E. 10^{-8}ans: A

6. 1 atomic mass unit is about:

- A. 1.66×10^{-31} kg
- B. 9.11×10^{-31} kg
- C. 1.66×10^{-27} kg
- D. 9.11×10^{-27} kg
- E. 1.66×10^{-25} kg

ans: C

7. The atomic number of an element is:

- A. the whole number nearest to its mass
- B. the number of protons in its nucleus
- C. the nearest whole number of hydrogen atoms having the same mass as a single atom of the given element
- D. the number of neutrons in its nucleus
- E. its order of discovery

ans: B

8. Iron has atomic number 26. Naturally mined iron contains isotopes of mass numbers 54, 56, 57, and 58. Which of the following statements is FALSE?

- A. Every atom of iron has 26 protons
- B. Some iron atoms have 30 neutrons
- C. Some iron atoms have 54 neutrons
- D. The isotopes may be separated in a mass spectrometer
- E. There are four kinds of naturally occurring iron atoms with the same chemical properties

ans: C

9. Let Z denote the atomic number and A denote the mass number of a nucleus. The number of neutrons in this nucleus is:

- A. Z
- B. $A - Z$
- C. $A - 2Z$
- D. A
- E. $2A - Z$

ans: B

10. The isotopes of an element:

- A. cannot be separated at all
- B. occur well separated in nature
- C. have similar chemical behavior
- D. cannot be separated by physical methods
- E. have equal masses

ans: C

11. Bromine, with atomic mass 79.942 u, is composed of nearly equal amounts of two isotopes, one of which contains 79 nucleons per atom. The mass number of the other isotope is:
- A. 78
 - B. 79
 - C. 80
 - D. 81
 - E. 82

ans: D

12. The mass density of an atomic nucleus is:
- A. about 10^{15} kg/m³
 - B. about 10^{12} kg/m³
 - C. increases with increasing nuclear mass
 - D. increases with decreasing nuclear radius
 - E. about the same as that of all other nuclei

ans: E

13. Volumes of atomic nuclei are proportional to:
- A. the mass number
 - B. the atomic number
 - C. the total nuclear spin
 - D. the number of neutrons
 - E. none of these

ans: A

14. A femtometer is:
- A. larger than 10^{-9} m
 - B. 10^{-9} m
 - C. 10^{-12} m
 - D. 10^{-15} m
 - E. 10^{-18} m

ans: D

15. A nucleus with a mass number of 64 has a mean radius of about:
- A. 4.8 fm
 - B. 19 fm
 - C. 77 fm
 - D. 260 fm
 - E. 2.6×10^5 fm

ans: A

16. A proton in a large nucleus:
- A. attracts all other protons
 - B. repels all other protons
 - C. repels all neutrons
 - D. attracts some protons and repels others
 - E. attracts some neutrons and repels others
- ans: D
17. Two protons are separated by 10^{-16} m. The nuclear (N), electrostatic (E), and gravitational (G) forces between these protons, in order of increasing strength, are:
- A. E, N, G
 - B. N, G, E
 - C. G, E, N
 - D. G, N, E
 - E. E, G, N
- ans: C
18. Two protons are about 10^{-10} m apart. Their relative motion is chiefly determined by:
- A. gravitational forces
 - B. electrical forces
 - C. nuclear forces
 - D. magnetic forces
 - E. torque due to electric dipole moments
- ans: B
19. The binding energy of a nucleus is the energy that must be supplied to:
- A. remove a nucleon
 - B. remove an alpha particle
 - C. remove a beta particle
 - D. separate the nucleus into its constituent nucleons
 - E. separate the nucleus into a collection of alpha particles
- ans: D
20. If a nucleus has mass M , Z protons (mass m_p), and N neutrons (mass m_n), its binding energy is equal to:
- A. Mc^2
 - B. $(M - Zm_p - Nm_n)c^2$
 - C. $(Zm_p + Nm_n - M)c^2$
 - D. $(Zm_p + Nm_n)c^2$
 - E. $(Zm_p - M)c^2$
- ans: C

21. Stable nuclei generally:
- A. have a greater number of protons than neutrons
 - B. have low mass numbers
 - C. have high mass numbers
 - D. are beta emitters
 - E. none of the above
- ans: E
22. Let A be the mass number and Z be the atomic number of a nucleus. Which of the following is approximately correct for light nuclei?
- A. $Z = 2A$
 - B. $Z = A$
 - C. $Z = A/2$
 - D. $Z = \sqrt{A}$
 - E. $Z = A^2$
- ans: C
23. The greatest binding energy per nucleon occurs for nuclides with masses near that of:
- A. helium
 - B. sodium
 - C. iron
 - D. mercury
 - E. uranium
- ans: C
24. Which of the following nuclides is least likely to be detected?
- A. ^{52}Fe ($Z = 26$)
 - B. ^{115}Nd ($Z = 60$)
 - C. ^{175}Lu ($Z = 71$)
 - D. ^{208}Pb ($Z = 82$)
 - E. ^{238}U ($Z = 92$)
- ans: B
25. The half-life of a radioactive substance is:
- A. half the time it takes for the entire substance to decay
 - B. usually about 50 years
 - C. the time for radium to change into lead
 - D. calculated from $E = mc^2$
 - E. the time for half the substance to decay
- ans: E

26. Which expression correctly describes the radioactive decay of a substance whose half-life is T ?

- A. $N(t) = N_0 e^{-(t \ln 2)/T}$
- B. $N(t) = N_0 e^{-t/T}$
- C. $N(t) = N_0 e^{-tT}$
- D. $N(t) = N_0 e^{-tT \ln 2}$
- E. $N(t) = N_0 e^{-t/T \ln 2}$

ans: A

27. Radioactive element A decays to the stable element B with a half-life T . Starting with a sample of pure A and no B, which graph below correctly shows the number of A atoms, N_A , as a function of time t ?

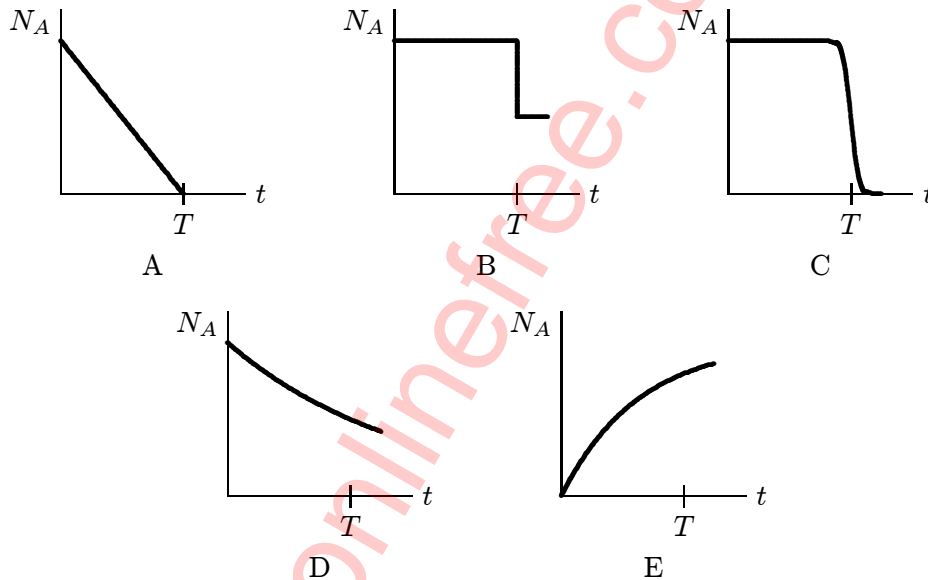

ans: D

28. A large collection of nuclei are undergoing alpha decay. The rate of decay at any instant is proportional to:

- A. the number of undecayed nuclei present at that instant
- B. the time since the decays started
- C. the time remaining before all have decayed
- D. the half-life of the decay
- E. the average time between decays

ans: A

29. The relation between the disintegration constant λ and the half-life T of a radioactive substance is:

- A. $\lambda = 2T$
- B. $\lambda = 1/T$
- C. $\lambda = 2/T$
- D. $\lambda T = \ln 2$
- E. $\lambda T = \ln(1/2)$

ans: D

30. Possible units for the disintegration constant λ are:

- A. kg/s
- B. s/kg
- C. hour
- D. day^{-1}
- E. cm^{-1}

ans: D

31. The half-life of a given nuclear disintegration $A \rightarrow B$:

- A. depends on the initial number of A atoms
- B. depends on the initial number of B atoms
- C. is an exponentially increasing function of time
- D. is an exponentially decreasing function of time
- E. none of the above

ans: E

32. The graph shows the activity R as a function of time t for three radioactive samples. Rank the samples according to their half-lives, shortest to longest.

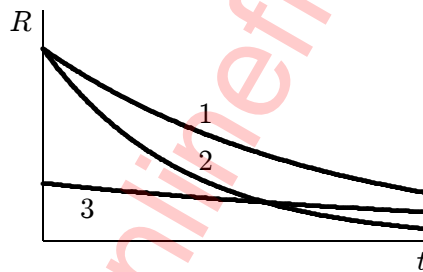

- A. 1, 2, 3
- B. 1, 3, 2
- C. 2, 1, 3
- D. 2, 3, 1
- E. 3, 1, 2

ans: C

33. The half-life of radium is about 1600 years. If a rock initially contains 1 g of radium, the amount left after 6400 years will be about:

- A. 938 mg
- B. 62 mg
- C. 31 mg
- D. 16 mg
- E. less than 16 mg

ans: C

34. Starting with a sample of pure ^{66}Cu , $7/8$ of it decays into Zn in 15 minutes. The corresponding half-life is:
- A. 15 minutes
 - B. 5 minutes
 - C. 7 minutes
 - D. 3.75 minutes
 - E. 10 minutes
- ans: B
35. ^{210}Bi (an isotope of bismuth) has a half-life of 5.0 days. The time for three-quarters of a sample of ^{210}Bi to decay is:
- A. 2.5 days
 - B. 10 days
 - C. 15 days
 - D. 20 days
 - E. 3.75 days
- ans: B
36. Radioactive ^{90}Sr has a half-life of 30 years. What percent of a sample of ^{90}Sr will remain after 60 years?
- A. 0%
 - B. 25%
 - C. 50%
 - D. 75%
 - E. 14%
- ans: B
37. The half-life of a radioactive isotope is 6.5 h. If there are initially 48×10^{32} atoms of this isotope, the number of atoms of this isotope remaining after 26 h is:
- A. 12×10^{32}
 - B. 6×10^{32}
 - C. 3×10^{32}
 - D. 6×10^4
 - E. 3×10^2
- ans: C
38. At the end of 14 min, $1/16$ of a sample of radioactive polonium remains. The corresponding half-life is:
- A. $(7/8)$ min
 - B. $(8/7)$ min
 - C. $(7/4)$ min
 - D. $(7/2)$ min
 - E. $(14/3)$ min
- ans: D

39. The half-life of a radioactive isotope is 140 days. In how many days does the decay rate of a sample of this isotope decrease to one-fourth of its initial decay rate?

- A. 35
- B. 105
- C. 187
- D. 210
- E. 280

ans: E

40. Of the three common types of radiation (alpha, beta, gamma) from radioactive sources, electric charge is carried by:

- A. only beta and gamma
- B. only beta
- C. only alpha and gamma
- D. only alpha
- E. only alpha and beta

ans: E

41. An alpha particle is:

- A. a helium atom with two electrons removed
- B. an aggregate of two or more electrons
- C. a hydrogen atom
- D. the ultimate unit of positive charge
- E. sometimes negatively charged

ans: A

42. A nucleus with mass number A and atomic number Z emits an alpha particle. The mass number and atomic number, respectively, of the daughter nucleus are:

- A. $A, Z - 2$
- B. $A - 2, Z - 2$
- C. $A - 2, Z$
- D. $A - 4, Z$
- E. $A - 4, Z - 2$

ans: E

43. Radioactive polonium, ^{214}Po ($Z = 84$), decays by alpha emission to:

- A. ^{214}Po ($Z = 84$)
- B. ^{210}Pb ($Z = 82$)
- C. ^{214}At ($Z = 85$)
- D. ^{218}Po ($Z = 84$)
- E. ^{210}Bi ($Z = 83$)

ans: B

44. A radium atom, ^{226}Ra ($Z = 86$) emits an alpha particle. The number of protons in the resulting atom is:
- A. 84
 - B. 85
 - C. 86
 - D. 88
 - E. some other number
- ans: A
45. Some alpha emitters have longer half-lives than others because:
- A. their alpha particles have greater mass
 - B. their alpha particles have less mass
 - C. their barriers to decay are higher and wider
 - D. their barriers to decay are lower and narrower
 - E. their decays include the emission of a photon
- ans: C
46. In an alpha decay the disintegration energy appears chiefly as:
- A. photon energies
 - B. the kinetic energies of the alpha and the daughter nucleus
 - C. the excitation energy of the daughter nucleus
 - D. the excitation energy of the alpha particle
 - E. heat
- ans: B
47. Rank the following collections of particles according to the total binding energy of all the particles in each collection, least to greatest.
- collection 1: ^{244}Pu ($Z = 94$) nucleus alone
 - collection 2: ^{240}U ($Z = 92$) nucleus, α particle
 - collection 3: ^{240}U ($Z = 92$) nucleus, two separated protons, two separated neutrons
- A. 1, 2, 3
 - B. 3, 2, 1
 - C. 2, 1, 3
 - D. 1, 3, 2
 - E. 2, 3, 1
- ans: D
48. A beta particle is:
- A. a helium nucleus
 - B. an electron or a positron
 - C. a radioactive element
 - D. any negative particle
 - E. a hydrogen atom
- ans: B

49. Beta particles from various radioactive sources all have:
- A. the same mass
 - D. the same speed
 - B. the same charge
 - E. the same deflection
 - C. the same energy in a magnetic field
- ans: A
50. A radioactive atom X emits a β^- particle. The resulting atom:
- A. must be very reactive chemically
 - B. has an atomic number that is one more than that of X
 - C. has a mass number that is one less than that of X
 - D. must be radioactive
 - E. is the same chemical element as X
- ans: B
51. A nucleus with mass number A and atomic number Z undergoes β^- decay. The mass number and atomic number, respectively, of the daughter nucleus are:
- A. $A, Z - 1$
 - B. $A - 1, Z$
 - C. $A + 1, Z - 1$
 - D. $A, Z + 1$
 - E. $A, Z - 1$
- ans: D
52. A nucleus with mass number A and atomic number Z undergoes β^+ decay. The mass number and atomic number, respectively, of the daughter nucleus are:
- A. $A - 1, Z - 1$
 - B. $A - 1, Z + 1$
 - C. $A + 1, Z - 1$
 - D. $A, Z + 1$
 - E. $A, Z - 1$
- ans: E
53. In addition to the daughter nucleus and an electron or positron, the products of a beta decay include:
- A. a neutron
 - B. a neutrino
 - C. a proton
 - D. an alpha particle
 - E. no other particle
- ans: B

54. The energies of electrons emitted in β^- decays have a continuous spectrum because:
- A. the original neutron has a continuous spectrum
 - B. a neutrino can carry off energy
 - C. the emitted electron is free
 - D. energy is not conserved
 - E. the daughter nucleus may have any energy
- ans: B
55. If ^{204}Tl ($Z = 81$) emits a β^- particle from its nucleus:
- A. stable Tl is formed
 - B. ^{202}Hg ($Z = 80$) is formed
 - C. ^{204}Pb ($Z = 82$) is formed
 - D. radioactive Tl is formed
 - E. ^{197}Au ($Z = 79$) is formed
- ans: C
56. An atom of ^{235}U ($Z = 92$) disintegrates to ^{207}Pb ($Z = 82$) with a half-life of about a billion years by emitting seven alpha particles and _____ β^- particles:
- A. 3
 - B. 4
 - C. 5
 - D. 6
 - E. 7
- ans: B
57. When ordinary sodium (^{23}Na , $Z = 11$) is bombarded with deuterons, the products are a neutron and:
- A. ^{27}Al , $Z = 13$
 - B. ^{24}Na , $Z = 11$
 - C. ^{24}Mg , $Z = 12$
 - D. ^{25}Mg , $Z = 12$
 - E. ^{20}Ne , $Z = 10$
- ans: D
58. ^{65}Cu can be turned into ^{66}Cu , with no accompanying product except a gamma, if bombarded with:
- A. protons
 - B. neutrons
 - C. deuterons
 - D. electrons
 - E. alpha particles
- ans: B

59. Magnesium has atomic number 12, hydrogen has atomic number 1, and helium has atomic number 2. In the nuclear reaction $^{24}\text{Mg} + ^2\text{H} \rightarrow () + ^4\text{He}$ the missing quantity is:
- A. ^{23}Na ($Z = 11$)
 - B. ^{22}Ne ($Z = 10$)
 - C. ^{21}Na ($Z = 11$)
 - D. ^{21}Ne ($Z = 10$)
 - E. ^{22}Na ($Z = 11$)
- ans: E
60. Aluminum has atomic number 13, helium has atomic number 2, and silicon has atomic number 14. In the nuclear reaction $^{27}\text{Al} + ^4\text{He} \rightarrow ^{30}\text{Si} + ()$ the missing particle is:
- A. an α particle
 - B. a positron
 - C. an electron
 - D. a proton
 - E. a neutron
- ans: D
61. The ^{66}Cu ($Z = 29$) produced in a nuclear bombardment is unstable, changing to ^{66}Zn ($Z = 30$) by the emission of:
- A. a proton
 - B. a gamma ray photon
 - C. a positron
 - D. an electron
 - E. an alpha particle
- ans: D
62. When ordinary sulfur, ^{32}S ($Z = 16$), is bombarded with neutrons, the products are ^{32}P ($Z = 15$) and:
- A. alpha particles
 - B. protons
 - C. deuterons
 - D. gamma ray particles
 - E. electrons
- ans: B
63. A certain nucleus, after absorbing a neutron, emits a β^- and then splits into two alpha particles. The (A, Z) of the original nucleus must have been:
- A. 6, 2
 - B. 6, 3
 - C. 7, 2
 - D. 7, 3
 - E. 8, 4
- ans: D

64. When ^{23}Na ($Z = 11$) is bombarded with protons, the products are ^{20}Ne ($Z = 10$) and:
- A. a neutron
 - B. an alpha particle
 - C. a deuteron
 - D. a gamma ray particle
 - E. two beta particles
- ans: B
65. Bombardment of ^{28}Si ($Z = 14$) with alpha particles may produce:
- A. a proton and ^{31}P ($Z = 15$)
 - B. hydrogen and ^{32}S ($Z = 16$)
 - C. a deuteron and ^{27}Al ($Z = 13$)
 - D. helium and ^{31}P ($Z = 15$)
 - E. ^{35}Cl ($Z = 17$)
- ans: A
66. The becquerel is the correct unit to use in reporting the measurement of:
- A. the rate of decay of a radioactive source
 - B. the ability of a beam of gamma ray photons to produce ions in a target
 - C. the energy delivered by radiation to a target
 - D. the biological effect of radiation
 - E. none of the above
- ans: A
67. The gray is the correct unit to use in reporting the measurement of:
- A. the rate of decay of a radioactive source
 - B. the ability of a beam of gamma ray photons to produce ions in a target
 - C. the energy per unit mass of target delivered by radiation to a target
 - D. the biological effect of radiation
 - E. none of the above
- ans: C
68. The sievert is the correct unit to use in reporting the measurement of:
- A. the rate of decay of a radioactive source
 - B. the ability of a beam of gamma ray photons to produce ions in a target
 - C. the energy delivered by radiation to a target
 - D. the biological effect of radiation
 - E. none of the above
- ans: D

Chapter 43: ENERGY FROM THE NUCLEUS

1. If the nucleus of a lead atom were broken into two identical nuclei, the total mass of the resultant nuclei would be:
 - A. the same as before
 - B. greater than before
 - C. less than before
 - D. converted into radiation
 - E. converted into kinetic energy

ans: C

2. Consider the following energies:
 1. minimum energy needed to excite a hydrogen atom
 2. energy needed to ionize a hydrogen atom
 3. energy released in ^{235}U fission
 4. energy needed to remove a neutron from a ^{12}C nucleus

Rank them in order of increasing value.

- A. 1, 2, 3, 4
- B. 1, 3, 2, 4
- C. 1, 2, 4, 3
- D. 2, 1, 4, 3
- E. 2, 4, 1, 3

ans: C

3. The binding energy per nucleon:
 - A. increases for all fission events
 - B. increases for some, but not all, fission events
 - C. decreases for all fission events
 - D. decreases for some, but not all, fission events
 - E. remains the same for all fission events

ans: A

4. When uranium undergoes fission as a result of neutron bombardment, the energy released is due to:
 - A. oxidation of the uranium
 - B. kinetic energy of the bombarding neutrons
 - C. radioactivity of the uranium nucleus
 - D. radioactivity of the fission products
 - E. a reduction in binding energy

ans: E

5. The energy supplied by a thermal neutron in a fission event is essentially its:
- A. excitation energy
 - B. binding energy
 - C. kinetic energy
 - D. rest energy
 - E. electric potential energy
- ans: B
6. The barrier to fission comes about because the fragments:
- A. attract each other via the strong nuclear force
 - B. repel each other electrically
 - C. produce magnetic fields
 - D. have large masses
 - E. attract electrons electrically
- ans: A
7. ^{235}U is readily made fissionable by a thermal neutron but ^{238}U is not because:
- A. the neutron has a smaller binding energy in ^{236}U
 - B. the neutron has a smaller excitation energy in ^{236}U
 - C. the potential barrier for the fragments is less in ^{239}U
 - D. the neutron binding energy is greater than the barrier height for ^{236}U and less than the barrier height for ^{239}U
 - E. the neutron binding energy is less than the barrier height for ^{236}U and greater than the barrier height for ^{239}U
- ans: D
8. An explosion does not result from a small piece of ^{235}U because:
- A. it does not fission
 - B. the neutrons released move too fast
 - C. ^{238}U is required
 - D. too many neutrons escape, preventing a chain reaction from starting
 - E. a few neutrons must be injected to start the chain reaction
- ans: D
9. When ^{236}U fissions the fragments are:
- A. always ^{140}Xe and ^{94}Sr
 - B. always identical
 - C. never ^{140}Xe and ^{94}Sr
 - D. never identical
 - E. none of the above
- ans: E

10. Fission fragments usually decay by emitting:
- alpha particles
 - electrons and neutrinos
 - positrons and neutrinos
 - only neutrons
 - only electrons
- ans: B
11. When ^{236}U fissions, the products might be:
- ^{146}Ba , ^{89}Kr , and a proton
 - ^{146}Ba , ^{89}Kr , and a neutron
 - ^{148}Cs and ^{85}Br
 - ^{133}I , ^{92}Sr , and an alpha particle
 - two uranium nuclei
- ans: B
12. Consider all possible fission events. Which of the following statements is true?
- Light initial fragments have more protons than neutrons and heavy initial fragments have fewer protons than neutrons
 - Heavy initial fragments have more protons than neutrons and light initial fragments have fewer protons than neutrons
 - All initial fragments have more protons than neutrons
 - All initial fragments have about the same number of protons and neutrons
 - All initial fragments have more neutrons than protons
- ans: E
13. Which one of the following represents a fission reaction that can be activated by slow neutrons?
- $^{238}\text{U}_{92} + ^1_0\text{n} \rightarrow ^{90}\text{Kr}_{36} + ^{146}\text{Cs}_{55} + ^2_1\text{H} + ^1_0\text{n}$
 - $^{239}\text{Pu}_{94} + ^1_0\text{n} \rightarrow ^{96}\text{Sr}_{38} + ^{141}\text{Ba}_{56} + 3\ ^1_0\text{n}$
 - $^{238}\text{U}_{92} \rightarrow ^{234}\text{Th}_{90} + ^4_2\text{He}$
 - $^3_1\text{H} + ^2_1\text{H} \rightarrow ^4_2\text{He} + ^1_0\text{n}$
 - $^{107}\text{Ag}_{47} + ^1_0\text{n} \rightarrow ^{108}\text{Ag}_{47} \rightarrow ^{108}\text{Cd}_{48} + ^0_{-1}\text{e}$
- ans: B
14. In the uranium disintegration series:
- the emission of a β^- particle increases the mass number A by one and decreases the atomic number Z by one
 - the disintegrating element merely ejects atomic electrons
 - the emission of an α particle decreases the mass number A by four and decreases the atomic number Z by two
 - the nucleus always remains unaffected
 - the series of disintegrations continues until an element having eight outermost orbital electrons is obtained
- ans: C

15. Separation of the isotopes of uranium requires a physical, rather than chemical, method because:
- A. mixing other chemicals with uranium is too dangerous
 - B. the isotopes are chemically the same
 - C. the isotopes have exactly the same number of neutrons per nucleus
 - D. natural uranium contains only 0.7% ^{235}U
 - E. uranium is the heaviest element in nature
- ans: B
16. Which one of the following is NOT needed in a nuclear fission reactor?
- A. Moderator
 - B. Fuel
 - C. Coolant
 - D. Control device
 - E. Accelerator
- ans: E
17. The function of the control rods in a nuclear reactor is to:
- A. increase fission by slowing down the neutrons
 - B. decrease the energy of the neutrons without absorbing them
 - C. increase the ability of the neutrons to cause fission
 - D. decrease fission by absorbing neutrons
 - E. provide the critical mass for the fission reaction
- ans: D
18. A nuclear reactor is operating at a certain power level, with its multiplication factor adjusted to unity. The control rods are now used to reduce the power output to one-half its former value. After the reduction in power the multiplication factor is maintained at:
- A. $1/2$
 - B. $1/4$
 - C. 2
 - D. 4
 - E. 1
- ans: E
19. The purpose of a moderator in a nuclear reactor is to:
- A. provide neutrons for the fission process
 - B. slow down fast neutrons to increase the probability of capture by uranium
 - C. absorb dangerous gamma radiation
 - D. shield the reactor operator from dangerous radiation
 - E. none of the above
- ans: B

20. In a neutron-induced fission process, delayed neutrons come from:
- A. the fission products
 - B. the original nucleus just before it absorbs the neutron
 - C. the original nucleus just after it absorbs the neutron
 - D. the moderator material
 - E. the control rods
- ans: A
21. In a nuclear reactor the fissionable fuel is formed into pellets rather than finely ground and the pellets are mixed with the moderator. This reduces the probability of:
- A. non-fissioning absorption of neutrons
 - B. loss of neutrons through the reactor container
 - C. absorption of two neutrons by single fissionable nucleus
 - D. loss of neutrons in the control rods
 - E. none of the above
- ans: A
22. In a subcritical nuclear reactor:
- A. the number of fission events per unit time decreases with time
 - B. the number of fission events per unit time increases with time
 - C. each fission event produces fewer neutrons than when the reactor is critical
 - D. each fission event produces more neutrons than when the reactor is critical
 - E. none of the above
- ans: A
23. In the normal operation of a nuclear reactor:
- A. control rods are adjusted so the reactor is subcritical
 - B. control rods are adjusted so the reactor is critical
 - C. the moderating fluid is drained
 - D. the moderating fluid is continually recycled
 - E. none of the above
- ans: B
24. In a nuclear power plant, the power discharged to the environment:
- A. can be made zero by proper design
 - B. must be less than the electrical power generated
 - C. must be greater than the electrical power generated
 - D. can be entirely recycled to produce an equal amount of electrical power
 - E. is not any of the above
- ans: E

25. The binding energy per nucleon:
- increases for all fusion events
 - increases for some, but not all, fusion events
 - remains the same for some fusion events
 - decreases for all fusion events
 - decreases for some, but not all, fusion events
- ans: A
26. To produce energy by fusion of two nuclei, the nuclei must:
- have at least several thousand electron volts of kinetic energy
 - both be above iron in mass number
 - have more neutrons than protons
 - be unstable
 - be magic number nuclei
- ans: A
27. Which one of the following represents a fusion reaction that yields large amounts of energy?
- $^{238}\text{U}_{92} + ^1_0\text{n} \rightarrow ^{90}\text{Kr}_{36} + ^{146}\text{Cs}_{55} + ^2_1\text{H} + ^1_0\text{n}$
 - $^{239}\text{Pu}_{92} + ^1_0\text{n} \rightarrow ^{96}\text{Sr}_{38} + ^{141}\text{Ba}_{56} + 3^1_0\text{n}$
 - $^{238}\text{U}_{92} \rightarrow ^{234}\text{Th}_{90} + ^4_2\text{He}$
 - $^3_1\text{H} + ^2_1\text{H} \rightarrow ^4_2\text{He} + ^1_0\text{n}$
 - $^{107}\text{Ag}_{47} + ^1_0\text{n} \rightarrow ^{108}\text{Ag}_{47} \rightarrow ^{108}\text{Cd}_{48} + ^0_{-1}\text{e}$
- ans: D
28. The barrier to fusion comes about because protons:
- attract each other via the strong nuclear force
 - repel each other electrically
 - produce magnetic fields
 - attract neutrons via the strong nuclear force
 - attract electrons electrically
- ans: B
29. High temperatures are required in thermonuclear fusion so that:
- some nuclei are moving fast enough to overcome the barrier to fusion
 - there is a high probability some nuclei will strike each other head on
 - the atoms are ionized
 - thermal expansion gives the nuclei more room
 - the uncertainty principle can be circumvented
- ans: A
30. For a controlled nuclear fusion reaction, one needs:
- high number density n and high temperature T
 - high number density n and low temperature T
 - low number density n and high temperature T
 - low number density n and low temperature T
 - high number density n and temperature $T = 0\text{ K}$
- ans: A

31. Most of the energy produced by the Sun is due to:
- A. nuclear fission
 - B. nuclear fusion
 - C. chemical reaction
 - D. gravitational collapse
 - E. induced emfs associated with the Sun's magnetic field
- ans: B
32. Nuclear fusion in stars produces all the chemical elements with mass numbers less than:
- A. 56
 - B. 66
 - C. 70
 - D. 82
 - E. 92
- ans: A
33. Nuclear fusion in the Sun is increasing its supply of:
- A. hydrogen
 - B. helium
 - C. nucleons
 - D. positrons
 - E. neutrons
- ans: B
34. Which of the following chemical elements is not produced by thermonuclear fusion in stars?
- A. Carbon ($Z = 6, A \approx 12$)
 - B. Silicon ($Z = 14, A \approx 28$)
 - C. Oxygen ($Z = 8, A \approx 16$)
 - D. Mercury ($Z = 80, A \approx 200$)
 - E. Chromium ($Z = 24, A \approx 52$)
- ans: D
35. The first step of the proton-proton cycle is:
- A. ${}^1\text{H} + {}^1\text{H} \rightarrow {}^2\text{H}$
 - B. ${}^1\text{H} + {}^1\text{H} \rightarrow {}^2\text{H} + e^+ + \nu$
 - C. ${}^1\text{H} + {}^1\text{H} \rightarrow {}^2\text{H} + e^- + \nu$
 - D. ${}^1\text{H} + {}^1\text{H} \rightarrow {}^2\text{H} + \gamma$
 - E. ${}^1\text{H} + {}^1\text{H} \rightarrow {}^3\text{H} + e^- + \nu$
- ans: B
36. The overall proton-proton cycle is equivalent to:
- A. $2 {}^1\text{H} \rightarrow {}^2\text{H}$
 - B. $4 {}^1\text{H} \rightarrow {}^4\text{H}$
 - C. $4 {}^1\text{H} \rightarrow {}^4\text{H} + 4n$
 - D. $4 {}^1\text{H} + 2e^- \rightarrow {}^4\text{He} + 2\nu + 6\gamma$
 - E. $4 {}^1\text{H} + 2e^+ \rightarrow {}^4\text{He} + 2\nu + 3\gamma$
- ans: D

37. The energy released in a complete proton-proton cycle is about:
- A. 3 keV
 - B. 30 keV
 - C. 3 MeV
 - D. 30 MeV
 - E. 300 MeV
- ans: D
38. For purposes of a practical (energy producing) reaction one wants a disintegration energy Q that is:
- A. positive for fusion reactions and negative for fission reactions
 - B. negative for fusion reactions and positive for fission reactions
 - C. negative for both fusion and fission reactions
 - D. positive for both fusion and fission reactions
 - E. as close to zero as possible for both fusion and fission reactions
- ans: D
39. Lawson's number is $10^{20} \text{ s} \cdot \text{m}^{-3}$. If the density of deuteron nuclei is $2 \times 10^{21} \text{ m}^{-3}$ what should the confinement time be to achieve sustained fusion?
- A. 16 ms
 - B. 50 ms
 - C. 160 ms
 - D. 250 ms
 - E. 500 ms
- ans: B
40. Tokamaks confine deuteron plasmas using:
- A. thick steel walls
 - B. magnetic fields
 - C. laser beams
 - D. vacuum tubes
 - E. electric fields
- ans: B
41. Most magnetic confinement projects attempt:
- A. proton-proton fusion
 - B. proton-deuteron fusion
 - C. deuteron-deuteron fusion
 - D. deuteron-triton fusion
 - E. triton-triton fusion
- ans: C

42. Compared to fusion in a tokamak, laser fusion makes use of:

- A. smaller particle number densities
- B. greater particle number densities
- C. longer confinement times
- D. higher temperatures
- E. lower temperatures

ans: B

43. Most laser fusion projects attempt:

- A. proton-proton fusion
- B. proton-deuteron fusion
- C. deuteron-deuteron fusion
- D. deuteron-triton fusion
- E. triton-triton fusion

ans: D

44. In laser fusion, the laser light is:

- A. emitted by the reacting nuclei
- B. used to cause transitions between nuclear energy levels
- C. used to cause transitions between atomic energy levels
- D. used to replace the emitted gamma rays
- E. used to heat the fuel pellet

ans: E

www.allonlinefree.com

Chapter 44: QUARKS, LEPTONS, AND THE BIG BANG

- Which of the following particles is stable?
 - Neutron
 - Proton
 - Pion
 - Muon
 - Kaonans: B
- The stability of the proton is predicted by the laws of conservation of energy and conservation of:
 - momentum
 - angular momentum
 - baryon number
 - lepton number
 - strangenessans: C
- When a kaon decays via the strong interaction the products must include a:
 - baryon
 - lepton
 - strange particle
 - electron
 - neutrinoans: C
- A particle with spin angular momentum $\hbar/2$ is called a:
 - lepton
 - hadron
 - fermion
 - boson
 - electronans: C
- A particle with spin angular momentum \hbar is called a:
 - lepton
 - hadron
 - fermion
 - boson
 - electronans: D

6. An example of a fermion is a:

- A. photon
- B. pion
- C. neutrino
- D. kaon
- E. none of these

ans: C

7. An example of a boson is a:

- A. photon
- B. electron
- C. neutrino
- D. proton
- E. neutron

ans: A

8. All particles with spin angular momentum $\hbar/2$:

- A. interact via the strong force
- B. travel at the speed of light
- C. obey the Pauli exclusion principle
- D. have non-zero rest mass
- E. are charged

ans: C

9. All leptons interact with each other via the:

- A. strong force
- B. weak force
- C. electromagnetic force
- D. strange force
- E. none of these

ans: B

10. An electron participates in:

- A. the strong force only
- B. the strong and weak forces only
- C. the electromagnetic and gravitational forces only
- D. the electromagnetic, gravitational, and weak forces only
- E. the electromagnetic, gravitational, and strong forces only

ans: D

11. Which of the following particles has a lepton number of zero?

- A. e^+
- B. μ^+
- C. ν_e
- D. $\bar{\nu}_\mu$
- E. p

ans: E

12. Which of the following particles has a lepton number of +1?
- e^+
 - μ^+
 - μ^-
 - $\bar{\nu}_e$
 - p
- ans: C
13. π^+ represents a pion (a meson), μ^- represents a muon (a lepton), ν_e represents an electron neutrino (a lepton), ν_μ and p represents a proton represents a muon neutrino (a lepton). Which of the following decays might occur?
- $\pi^+ \rightarrow \mu^- + \nu_\mu$
 - $\pi^+ \rightarrow p + \nu_e$
 - $\pi^+ \rightarrow \mu^+ + \bar{\nu}_e$
 - $\pi^+ \rightarrow p + \bar{\nu}_\mu$
 - $\pi^+ \rightarrow \mu^+ + \nu_\mu$
- ans: E
14. A particle can decay to particles with greater total rest mass:
- only if antiparticles are produced
 - only if photons are also produced
 - only if neutrinos are also produced
 - only if the original particle has kinetic energy
 - never
- ans: E
15. The interaction $\pi^- + p \rightarrow \pi^- + \Sigma^+$ violates the principle of conservation of:
- baryon number
 - lepton number
 - strangeness
 - angular momentum
 - none of these
- ans: C
16. The interaction $\pi^- + p \rightarrow K^- + \Sigma^+$ violates the principle of conservation of:
- baryon number
 - lepton number
 - strangeness
 - angular momentum
 - none of these
- ans: E

17. A neutral muon cannot decay into two neutrinos. Of the following conservation laws, which would be violated if it did?
- A. Energy
 - B. Baryon number
 - C. Charge
 - D. Angular momentum
 - E. None of the above
- ans: D
18. A positron cannot decay into three neutrinos. Of the following conservation laws, which would be violated if it did?
- A. Energy
 - B. Baryon number
 - C. Lepton number
 - D. Linear momentum
 - E. Angular momentum
- ans: C
19. Two particles interact to produce only photons, with the original particles disappearing. The particles must have been:
- A. mesons
 - B. strange particles
 - C. strongly interacting
 - D. leptons
 - E. a particle, antiparticle pair
- ans: E
20. Two baryons interact to produce pions only, the original baryons disappearing. One of the baryons must have been:
- A. a proton
 - B. an omega minus
 - C. a sigma
 - D. an antiparticle
 - E. none of these
- ans: D
21. A baryon with strangeness -1 decays via the strong interaction into two particles, one of which is a baryon with strangeness 0 . The other might be:
- A. a baryon with strangeness 0
 - B. a baryon with strangeness $+1$
 - C. a meson with strangeness -1
 - D. a meson with strangeness $+1$
 - E. a meson with strangeness 0
- ans: C

22. A baryon with strangeness 0 decays via the strong interaction into two particles, one of which is a baryon with strangeness +1. The other might be:
- A. a baryon with strangeness 0
 - B. a baryon with strangeness +1
 - C. a baryon with strangeness -1
 - D. a meson with strangeness +1
 - E. a meson with strangeness -1
- ans: E
23. In order of increasing strength the four basic interactions are:
- A. gravitational, weak, electromagnetic, and strong
 - B. gravitational, electromagnetic, weak, and strong
 - C. weak, gravitational, electromagnetic, and strong
 - D. weak, electromagnetic, gravitational, and strong
 - E. weak, electromagnetic, strong, and gravitational
- ans: A
24. The two basic interactions that have finite ranges are:
- A. electromagnetic and gravitational
 - B. electromagnetic and strong
 - C. electromagnetic and weak
 - D. gravitational and weak
 - E. weak and strong
- ans: E
25. A certain process produces baryons that decay with a lifetime of 4×10^{-24} s. The decay is a result of:
- A. the gravitational interaction
 - B. the weak interaction
 - C. the electromagnetic interaction
 - D. the strong interaction
 - E. some combination of the above
- ans: D
26. A certain process produces mesons that decay with a lifetime of 6×10^{-10} s. The decay is a result of:
- A. the gravitational interaction
 - B. the weak interaction
 - C. the electromagnetic interaction
 - D. the strong interaction
 - E. some combination of the above
- ans: B

27. Compared to the lifetimes of particles that decay via the weak interaction, the lifetimes of particles that decay via the strong interaction are:
- A. 10^{-12} times as long
 - B. 10^{-23} times as long
 - C. 10^{24} times as long
 - D. 10^{12} times as long
 - E. about the same
- ans: A
28. Strangeness is conserved in:
- A. all particle decays
 - B. no particle decays
 - C. all weak particle decays
 - D. all strong particle decays
 - E. some strong particle decays
- ans: D
29. Different types of neutrinos can be distinguished from each other by:
- A. the directions of their spins
 - B. the leptons with which they interact
 - C. the baryons with which they interact
 - D. the number of photons that accompany them
 - E. their baryon numbers
- ans: B
30. All known quarks have:
- A. charges that are multiples of e and integer baryon numbers
 - B. charges that are multiples of e and baryon numbers that are either $+1/3$ or $-1/3$
 - C. charges that are multiples of $e/3$ and integer baryon numbers
 - D. charges that are multiples of $e/3$ and baryon numbers that are either $+1/3$ or $-1/3$
 - E. charges that are multiples of $2e/3$ and baryon numbers that are either $+1/3$ or $-1/3$
- ans: D
31. The baryon number of a quark is:
- A. 0
 - B. $1/2$
 - C. $1/3$
 - D. $2/3$
 - E. 1
- ans: C

32. Quarks are the constituents of:
- A. all particles
 - B. all leptons
 - C. all strongly interacting particles
 - D. only strange particles
 - E. only mesons
- ans: C

33. Any meson is a combination of:
- A. three quarks
 - B. two quarks and an antiquark
 - C. one quark and two antiquarks
 - D. one quark and one antiquark
 - E. two quarks
- ans: D

34. Any baryon is a combination of:
- A. three quarks
 - B. two quarks and an antiquark
 - C. one quark and two antiquarks
 - D. one quark and one antiquark
 - E. two quarks
- ans: A

35. The quark content of a proton is:
- A. uuu
 - B. uud
 - C. udd
 - D. ddd
 - E. uds
- ans: B

36. The quark content of a π^+ meson is:
- A. uu
 - B. $u\bar{u}$
 - C. ud
 - D. $u\bar{d}$
 - E. $\bar{d}d$
- ans: D

37. In terms of quark content a beta decay can be written:
- A. $udd \rightarrow uud + e^- + \nu$
 - B. $udd \rightarrow udd + d\bar{d} + \nu$
 - C. $udd \rightarrow udd + d\bar{d} + e^-$
 - D. $udd \rightarrow uud + u\bar{d} + \nu$
 - E. $udd \rightarrow uud + u\bar{d} + e^- + \nu$
- ans: A

38. The up quark u has charge $+2e/3$ and strangeness 0; the down quark d has charge $-e/3$ and strangeness 0; the strange quark s has charge $-e/3$ and strangeness -1 . This means there can be no baryon with:
- A. charge 0 and strangeness 0
 - B. charge $-e$ and strangeness -1
 - C. charge $+e$ and strangeness -1
 - D. charge $+e$ and strangeness -2
 - E. charge 0 and strangeness $+2$
- ans: C
39. The up quark u has charge $+2e/3$ and strangeness 0; the down quark d has charge $-e/3$ and strangeness 0; the strange quark s has charge $-e/3$ and strangeness -1 . This means there can be no meson with:
- A. charge 0 and strangeness -1
 - B. charge $-e$ and strangeness -1
 - C. charge $+e$ and strangeness -1
 - D. charge $+e$ and strangeness $+1$
 - E. charge 0 and strangeness $+1$
- ans: C
40. Messenger particles of the electromagnetic interaction are called:
- A. gluons
 - B. photons
 - C. W and Z
 - D. gravitons
 - E. pions
- ans: B
41. Messenger particles of the strong interaction are called:
- A. gluons
 - B. photons
 - C. W and Z
 - D. gravitons
 - E. pions
- ans: A
42. Messenger particles of the weak interaction are called:
- A. gluons
 - B. photons
 - C. W and Z
 - D. gravitons
 - E. pions
- ans: C

43. A down quark can be changed into an up quark (plus other particles perhaps) by
- A. the gravitational interaction
 - B. the electromagnetic interaction
 - C. the weak interaction
 - D. the strong interaction
 - E. none of these
- ans: C
44. The color theory explains why quarks:
- A. form particles in pairs and triplets
 - B. have charge that is a multiple of $e/3$
 - C. have spin
 - D. have mass
 - E. none of the above
- ans: A
45. Color is carried by:
- A. only quarks
 - B. only leptons
 - C. only quarks and leptons
 - D. only quarks and gluons
 - E. only photons and gluons
- ans: D
46. Hubble's law is evidence that:
- A. the speed of light is increasing
 - B. the universe is expanding
 - C. the Earth is slowing down in its orbit
 - D. galaxies have rotational motion
 - E. none of the above
- ans: B
47. Objects in the universe are receding from us with a speed that is proportional to:
- A. the reciprocal of their distance from us
 - B. the reciprocal of the square of their distance from us
 - C. their distance from us
 - D. the square of their distance from us
 - E. their distance from the center of the universe
- ans: C

48. The velocities of distant objects in the universe indicate that the time elapsed since the big bang is about:
- A. 10^5 y
 - B. 10^{10} y
 - C. 10^{15} y
 - D. 10^{20} y
 - E. 10^{25} y
- ans: B
49. The intensity of the microwave background radiation, a remnant of the big bang:
- A. is greatest in directions toward the center of the galaxy
 - B. is least in directions toward the center of the galaxy
 - C. is proportional to the reciprocal of the distance from us
 - D. is proportional to the square of the distance from us
 - E. is nearly the same in all directions
- ans: E
50. As a result of the big bang there is, in addition to the microwave background radiation, a uniform distribution of background:
- A. electrons
 - B. quarks
 - C. gluons
 - D. neutrinos
 - E. atoms
- ans: D
51. Dark matter is suspected to exist in the universe because:
- A. the night sky is dark between stars
 - B. the orbital period of stars in the outer parts of a galaxy is greater than the orbital period of stars near the galactic center
 - C. the orbital period of stars in the outer parts of a galaxy is less than the orbital period of stars near the galactic center
 - D. the orbital period of stars in the outer parts of a galaxy is about the same as the orbital period of stars near the galactic center
 - E. all galaxies have about the same mass
- ans: D
52. If dark matter did not exist it is likely that:
- A. the universe would expand forever
 - B. the universe would begin contracting soon
 - C. the night sky would be brighter
 - D. the night sky would be darker
 - E. we would be able to see the center of the universe
- ans: A