

p

# Compilers

*Principles, Techniques, & Tools*

Second Edition

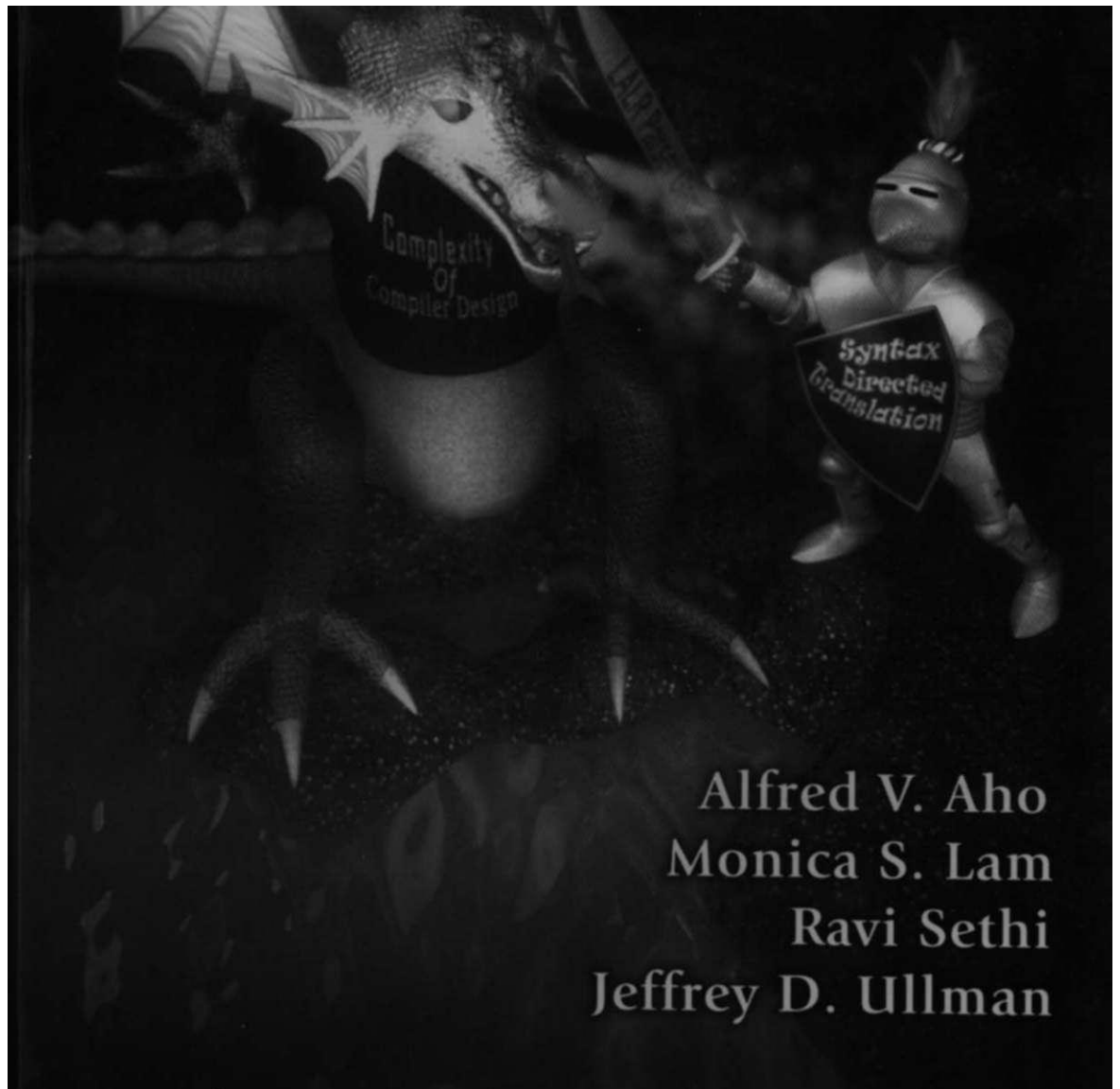

Second  
Edition

Alfred V. Aho  
Monica S. Lam  
Ravi Sethi  
Jeffrey D. Ullman

# Compilers

*Principles, Techniques, & Tools*

**Second Edition**

**Alfred V. Aho**  
*Columbia University*

**Monica S. Lam**  
*Stanford University*

**Ravi Sethi**  
*Avaya*

**Jeffrey D. Ullman**  
*Stanford University*



Boston San Francisco New York  
London Toronto Sydney Tokyo Singapore Madrid  
Mexico City Munich Paris Cape Town Hong Kong Montreal

Publisher	Greg Tobin
Executive Editor	Michael Hirsch
Acquisitions Editor	Matt Goldstein
Project Editor	Katherine Harutunian
Associate Managing Editor	Jeffrey Holcomb
Cover Designer	Joyce Cosentino Wells
Digital Assets Manager	Marianne Groth
Media Producer	Bethany Tidd
Senior Marketing Manager	Michelle Brown
Marketing Assistant	Sarah Milmore
Senior Author Support/ Technology Specialist	Joe Vetere
Senior Manufacturing Buyer	Carol <i>Melville</i>
Cover Image	Scott Ullman of Strange Tonic Productions ( <a href="http://www.strangetonic.com">www.strangetonic.com</a> )

Many of the designations used by manufacturers and sellers to distinguish their products are claimed as trademarks. Where those designations appear in this book, and Addison-Wesley was aware of a trademark claim, the designations have been printed in initial caps or all caps.

This interior of this book was composed in L<sup>A</sup>T<sub>E</sub>X.

#### Library of Congress Cataloging-in-Publication Data

Compilers : principles, techniques, and tools / Alfred V. Aho ... [et al.]. ~ 2nd ed.  
p. cm.

Rev. ed. of: Compilers, principles, techniques, and tools / Alfred V. Aho, Ravi Sethi, Jeffrey D. Ullman. 1986.

ISBN 0-321-48681-1 (alk. paper)

1. Compilers (Computer programs) I. Aho, Alfred V. II. Aho, Alfred V.

Compilers, principles, techniques, and tools.

QA76.76.C65A37 2007

005.4'53~dc22

2006024333

Copyright © 2007 Pearson Education, Inc. All rights reserved. No part of this publication may be reproduced, stored in a retrieval system, or transmitted, in any form or by any means, electronic, mechanical, photocopying, recording, or otherwise, without the prior written permission of the publisher. Printed in the *United States of America*. For information on obtaining permission for use of material in this work, please submit a written request to Pearson Education, Inc., Rights and Contracts Department, 75 Arlington Street, Suite 300, Boston, MA 02116, fax your request to 617-848-7047, or e-mail at <http://www.pearsoned.com/legal/permissions.htm>.

# Preface

In the time since the 1986 edition of this book, the world of compiler design has changed significantly. Programming languages have evolved to present new compilation problems. Computer architectures offer a variety of resources of which the compiler designer must take advantage. Perhaps most interestingly, the venerable technology of code optimization has found use outside compilers. It is now used in tools that find bugs in software, and most importantly, find security holes in existing code. And much of the "front-end" technology — grammars, regular expressions, parsers, and syntax-directed translators — are still in wide use.

Thus, our philosophy from previous versions of the book has not changed. We recognize that few readers will build, or even maintain, a compiler for a major programming language. Yet the models, theory, and algorithms associated with a compiler can be applied to a wide range of problems in software design and software development. We therefore emphasize problems that are most commonly encountered in designing a language processor, regardless of the source language or target machine.

## Use of the Book

It takes at least two quarters or even two semesters to cover all or most of the material in this book. It is common to cover the first half in an undergraduate course and the second half of the book — stressing code optimization — in a second course at the graduate or mezzanine level. Here is an outline of the chapters:

Chapter 1 contains motivational material and also presents some background issues in computer architecture and programming-language principles.

Chapter 2 develops a miniature compiler and introduces many of the important concepts, which are then developed in later chapters. The compiler itself appears in the appendix.

Chapter 3 covers lexical analysis, regular expressions, finite-state machines, and scanner-generator tools. This material is fundamental to text-processing of all sorts.

Chapter 4 covers the major parsing methods, top-down (recursive-descent, LL) and bottom-up (LR and its variants).

Chapter 5 introduces the principal ideas in syntax-directed definitions and syntax-directed translations.

Chapter 6 takes the theory of Chapter 5 and shows how to use it to generate intermediate code for a typical programming language.

Chapter 7 covers run-time environments, especially management of the run-time stack and garbage collection.

Chapter 8 is on object-code generation. It covers construction of basic blocks, generation of code from expressions and basic blocks, and register-allocation techniques.

Chapter 9 introduces the technology of code optimization, including flow graphs, data-flow frameworks, and iterative algorithms for solving these frameworks.

Chapter 10 covers instruction-level optimization. The emphasis is on the extraction of parallelism from small sequences of instructions and scheduling them on single processors that can do more than one thing at once.

Chapter 11 talks about larger-scale parallelism detection and exploitation. Here, the emphasis is on numeric codes that have many tight loops that range over multidimensional arrays.

Chapter 12 is on interprocedural analysis. It covers pointer analysis, aliasing, and data-flow analysis that takes into account the sequence of procedure calls that reach a given point in the code.

Courses from material in this book have been taught at Columbia, Harvard, and Stanford. At Columbia, a senior/first-year graduate course on programming languages and translators has been regularly offered using material from the first eight chapters. A highlight of this course is a semester-long project in which students work in small teams to create and implement a little language of their own design. The student-created languages have covered diverse application domains including quantum computation, music synthesis, computer graphics, gaming, matrix operations and many other areas. Students use compiler-component generators such as ANTLR, Lex, and Yacc and the syntax-directed translation techniques discussed in chapters two and five to build their compilers. A follow-on graduate course has focused on material in Chapters 9 through 12, emphasizing code generation and optimization for contemporary machines including network processors and multiprocessor architectures.

At Stanford, a one-quarter introductory course covers roughly the material in Chapters 1 through 8, although there is an introduction to global code optimization from Chapter 9. The second compiler course covers Chapters 9 through 12, plus the more advanced material on garbage collection from Chapter 7. Students use a locally developed, Java-based system called Joeq for implementing data-flow analysis algorithms.

## Prerequisites

The reader should possess some "computer-science sophistication," including at least a second course on programming, and courses in data structures and discrete mathematics. Knowledge of several different programming languages is useful.

## Exercises

The book contains extensive exercises, with some for almost every section. We indicate harder exercises or parts of exercises with an exclamation point. The hardest exercises have a double exclamation point.

## Gradiance On-Line Homeworks

A feature of the new edition is that there is an accompanying set of on-line homeworks using a technology developed by Gradiance Corp. Instructors may assign these homeworks to their class, or students not enrolled in a class may enroll in an "omnibus class" that allows them to do the homeworks as a tutorial (without an instructor-created class). Gradiance questions look like ordinary questions, but your solutions are sampled. If you make an incorrect choice you are given specific advice or feedback to help you correct your solution. If your instructor permits, you are allowed to try again, until you get a perfect score.

A subscription to the Gradiance service is offered with all new copies of this text sold in North America. For more information, visit the Addison-Wesley web site [www.aw.com/gradiance](http://www.aw.com/gradiance) or send email to [computing@aw.com](mailto:computing@aw.com).

## Support on the World Wide Web

The book's home page is

`dragonbook.Stanford.edu`

Here, you will find errata as we learn of them, and backup materials. We hope to make available the notes for each offering of compiler-related courses as we teach them, including homeworks, solutions, and exams. We also plan to post descriptions of important compilers written by their implementers.

## Acknowledgements

Cover art is by S. D. Ullman of Strange Tonic Productions.

Jon Bentley gave us extensive comments on a number of chapters of an earlier draft of this book. Helpful comments and errata were received from:

Domenico Bianculli, Peter Bosch, Marcio Buss, Marc Eaddy, Stephen Edwards, Vibhav Garg, Kim Hazelwood, Gaurav Kc, Wei Li, Mike Smith, Art Stamness, Krysta Svore, Olivier Tardieu, and Jia Zeng. The help of all these people is gratefully acknowledged. Remaining errors are ours, of course.

In addition, Monica would like to thank her colleagues on the SUIF compiler team for an 18-year lesson on compiling: Gerald Aigner, Dzintars Avots, Saman Amarasinghe, Jennifer Anderson, Michael Carbin, Gerald Cheong, Amer Diwan, Robert French, Anwar Ghuloum, Mary Hall, John Hennessy, David Heine, Shih-Wei Liao, Amy Lim, Benjamin Livshits, Michael Martin, Dror Maydan, Todd Mowry, Brian Murphy, Jeffrey Oplinger, Karen Pieper, Martin Rinard, Olatunji Ruwase, Constantine Sapuntzakis, Patrick Sathyanathan, Michael Smith, Steven Tjiang, Chau-Wen Tseng, Christopher Unkel, John Whaley, Robert Wilson, Christopher Wilson, and Michael Wolf.

A. V. A., Chatham NJ  
M. S. L., Menlo Park CA  
R. S., Far Hills NJ  
J. D. U., Stanford CA  
June, 2006

# Table of Contents

<b>1</b>	<b>Introduction</b>	<b>1</b>
1.1	Language Processors	1
1.1.1	Exercises for Section 1.1	3
1.2	The Structure of a Compiler	4
1.2.1	Lexical Analysis	5
1.2.2	Syntax Analysis	8
1.2.3	Semantic Analysis	8
1.2.4	Intermediate Code Generation	9
1.2.5	Code Optimization	10
1.2.6	Code Generation	10
1.2.7	Symbol-Table Management	11
1.2.8	The Grouping of Phases into Passes	11
1.2.9	Compiler-Construction Tools	12
1.3	The Evolution of Programming Languages	12
1.3.1	The Move to Higher-level Languages	13
1.3.2	Impacts on Compilers	14
1.3.3	Exercises for Section 1.3	14
1.4	The Science of Building a Compiler	15
1.4.1	Modeling in Compiler Design and Implementation	15
1.4.2	The Science of Code Optimization	15
1.5	Applications of Compiler Technology	17
1.5.1	Implementation of High-Level Programming Languages	17
1.5.2	Optimizations for Computer Architectures	19
1.5.3	Design of New Computer Architectures	21
1.5.4	Program Translations	22
1.5.5	Software Productivity Tools	23
1.6	Programming Language Basics	25
1.6.1	The Static/Dynamic Distinction	25
1.6.2	Environments and States	26
1.6.3	Static Scope and Block Structure	28
1.6.4	Explicit Access Control	31
1.6.5	Dynamic Scope	31
1.6.6	Parameter Passing Mechanisms	33



TABLE OF CONTENTS

1.6.7	Aliasing . . . . .	35
1.6.8	Exercises for Section 1.6 . . . . .	35
1.7	Summary of Chapter 1. . . . .	36
1.8	References for Chapter 1. . . . .	38
 <b>A Simple Syntax-Directed Translator</b>		 <b>39</b>
2.1	Introduction . . . . .	40
2.2	Syntax Definition . . . . .	42
2.2.1	Definition of Grammars. . . . .	42
2.2.2	Derivations. . . . .	44
2.2.3	Parse Trees. . . . .	45
2.2.4	Ambiguity. . . . .	47
2.2.5	Associativity of Operators . . . . .	48
2.2.6	Precedence of Operators. . . . .	48
2.2.7	Exercises for Section 2.2. . . . .	51
2.3	Syntax-Directed Translation . . . . .	52
2.3.1	Postfix Notation. . . . .	53
2.3.2	Synthesized Attributes. . . . .	54
2.3.3	Simple Syntax-Directed Definitions. . . . .	56
2.3.4	Tree Traversals . . . . .	56
2.3.5	Translation Schemes. . . . .	57
2.3.6	Exercises for Section 2.3. . . . .	60
2.4	Parsing . . . . .	60
2.4.1	Top-Down Parsing . . . . .	61
2.4.2	Predictive Parsing. . . . .	64
2.4.3	When to Use e-Productions. . . . .	65
2.4.4	Designing a Predictive Parser. . . . .	66
2.4.5	Left Recursion. . . . .	67
2.4.6	Exercises for Section 2.4. . . . .	68
2.5	A Translator for Simple Expressions. . . . .	68
2.5.1	Abstract and Concrete Syntax. . . . .	69
2.5.2	Adapting the Translation Scheme. . . . .	70
2.5.3	Procedures for the Nonterminals. . . . .	72
2.5.4	Simplifying the Translator. . . . .	73
2.5.5	The Complete Program . . . . .	74
2.6	Lexical Analysis. . . . .	76
2.6.1	Removal of White Space and Comments. . . . .	77
2.6.2	Reading Ahead . . . . .	78
2.6.3	Constants. . . . .	78
2.6.4	Recognizing Keywords and Identifiers. . . . .	79
2.6.5	A Lexical Analyzer. . . . .	81
2.6.6	Exercises for Section 2.6. . . . .	84
2.7	Symbol Tables . . . . .	85
2.7.1	Symbol Table Per Scope. . . . .	86
2.7.2	The Use of Symbol Tables. . . . .	89

2.8	Intermediate Code Generation. . . . .	91
2.8.1	Two Kinds of Intermediate Representations. . . . .	91
2.8.2	Construction of Syntax Trees. . . . .	92
2.8.3	Static Checking. . . . .	97
2.8.4	Three-Address Code. . . . .	99
2.8.5	Exercises for Section 2.8. . . . .	105
2.9	Summary of Chapter 2. . . . .	105
<b>3</b>	<b>Lexical Analysis</b>	
3.1	The Role of the Lexical Analyzer. . . . .	109
3.1.1	Lexical Analysis Versus Parsing. . . . .	110
3.1.2	Tokens, Patterns, and Lexemes. . . . .	111
3.1.3	Attributes for Tokens. . . . .	112
3.1.4	Lexical Errors. . . . .	113
3.1.5	Exercises for Section 3.1. . . . .	114
3.2	Input Buffering. . . . .	115
3.2.1	Buffer Pairs. . . . .	115
3.2.2	Sentinels. . . . .	116
3.3	Specification of Tokens. . . . .	116
3.3.1	Strings and Languages. . . . .	117
3.3.2	Operations on Languages. . . . .	119
3.3.3	Regular Expressions. . . . .	120
3.3.4	Regular Definitions. . . . .	123
3.3.5	Extensions of Regular Expressions. . . . .	124
3.3.6	Exercises for Section 3.3. . . . .	125
3.4	Recognition of Tokens. . . . .	128
3.4.1	Transition Diagrams. . . . .	130
3.4.2	Recognition of Reserved Words and Identifiers. . . . .	132
3.4.3	Completion of the Running Example. . . . .	133
3.4.4	Architecture of a Transition-Diagram-Based Lexical Analyzer. . . . .	134
3.4.5	Exercises for Section 3.4. . . . .	136
3.5	The Lexical-Analyzer Generator <b>Lex</b> . . . . .	140
3.5.1	Use of <b>Lex</b> . . . . .	140
3.5.2	Structure of <b>Lex</b> Programs. . . . .	141
3.5.3	Conflict Resolution in <b>Lex</b> . . . . .	144
3.5.4	The Lookahead Operator. . . . .	144
3.5.5	Exercises for Section 3.5. . . . .	146
3.6	Finite Automata. . . . .	147
3.6.1	Nondeterministic Finite Automata. . . . .	147
3.6.2	Transition Tables. . . . .	148
3.6.3	Acceptance of Input Strings by Automata. . . . .	149
3.6.4	Deterministic Finite Automata. . . . .	149
3.6.5	Exercises for Section 3.6. . . . .	151
3.7	From Regular Expressions to Automata. . . . .	152

3.7.1	Conversion of an NFA to a DFA . . . . .	152
3.7.2	Simulation of an NFA . . . . .	156
3.7.3	Efficiency of NFA Simulation . . . . .	157
3.7.4	Construction of an NFA from a Regular Expression . . . . .	159
3.7.5	Efficiency of String-Processing Algorithms . . . . .	163
3.7.6	Exercises for Section 3.7. . . . .	166
3.8	Design of a Lexical-Analyzer Generator. . . . .	166
3.8.1	The Structure of the Generated Analyzer. . . . .	167
3.8.2	Pattern Matching Based on NFA's. . . . .	168
3.8.3	DFA's for Lexical Analyzers. . . . .	170
3.8.4	Implementing the Lookahead Operator. . . . .	171
3.8.5	Exercises for Section 3.8. . . . .	172
3.9	Optimization of DFA-Based Pattern Matchers. . . . .	173
3.9.1	Important States of an NFA. . . . .	173
3.9.2	Functions Computed From the Syntax Tree. . . . .	175
3.9.3	Computing <i>unliable</i> , <i>firstpos</i> , and <i>lastpos</i> . . . . .	176
3.9.4	Computing <i>followpos</i> . . . . .	177
3.9.5	Converting a Regular Expression Directly to a DFA . . . . .	179
3.9.6	Minimizing the Number of States of a DFA. . . . .	180
3.9.7	State Minimization in Lexical Analyzers. . . . .	184
3.9.8	Trading Time for Space in DFA Simulation. . . . .	185
3.9.9	Exercises for Section 3.9. . . . .	186
3.10	Summary of Chapter 3. . . . .	187
3.11	References for Chapter 3. . . . .	189
<b>4</b>	<b>Syntax Analysis</b> . . . . .	<b>191</b>
4.1	Introduction. . . . .	192
4.1.1	The Role of the Parser. . . . .	192
4.1.2	Representative Grammars. . . . .	193
4.1.3	Syntax Error Handling. . . . .	194
4.1.4	Error-Recovery Strategies . . . . .	195
4.2	Context-Free Grammars. . . . .	197
4.2.1	The Formal Definition of a Context-Free Grammar . . . . .	197
4.2.2	Notational Conventions. . . . .	198
4.2.3	Derivations. . . . .	199
4.2.4	Parse Trees and Derivations. . . . .	201
4.2.5	Ambiguity. . . . .	203
4.2.6	Verifying the Language Generated by a Grammar . . . . .	204
4.2.7	Context-Free Grammars Versus Regular Expressions . . . . .	205
4.2.8	Exercises for Section 4.2 . . . . .	206
4.3	Writing a Grammar. . . . .	209
4.3.1	Lexical Versus Syntactic Analysis . . . . .	209
4.3.2	Eliminating Ambiguity. . . . .	210
4.3.3	Elimination of Left Recursion . . . . .	212
4.3.4	Left Factoring . . . . .	214

4.3.5	Non-Context-Free Language Constructs . . . . .	215
4.3.6	Exercises for Section 4.3. . . . .	216
4.4	Top-Down Parsing . . . . .	217
4.4.1	Recursive-Descent Parsing . . . . .	219
4.4.2	FIRST and FOLLOW. . . . .	220
4.4.3	LL(1) Grammars. . . . .	222
4.4.4	Nonrecursive Predictive Parsing . . . . .	226
4.4.5	Error Recovery in Predictive Parsing . . . . .	228
4.4.6	Exercises for Section 4.4. . . . .	231
4.5	Bottom-Up Parsing . . . . .	233
4.5.1	Reductions. . . . .	234
4.5.2	Handle Pruning . . . . .	235
4.5.3	Shift-Reduce Parsing . . . . .	236
4.5.4	Conflicts During Shift-Reduce Parsing. . . . .	238
4.5.5	Exercises for Section 4.5. . . . .	240
4.6	Introduction to LR Parsing: Simple LR . . . . .	241
4.6.1	Why LR Parsers?. . . . .	241
4.6.2	Items and the LR(0) Automaton. . . . .	242
4.6.3	The LR-Parsing Algorithm . . . . .	248
4.6.4	Constructing SLR-Parsing Tables. . . . .	252
4.6.5	Viable Prefixes. . . . .	256
4.6.6	Exercises for Section 4.6. . . . .	257
4.7	More Powerful LR Parsers. . . . .	259
4.7.1	Canonical LR(1) Items. . . . .	260
4.7.2	Constructing LR(1) Sets of Items. . . . .	261
4.7.3	Canonical LR(1) Parsing Tables . . . . .	265
4.7.4	Constructing LALR Parsing Tables. . . . .	266
4.7.5	Efficient Construction of LALR Parsing Tables. . . . .	270
4.7.6	Compaction of LR Parsing Tables. . . . .	275
4.7.7	Exercises for Section 4.7. . . . .	277
4.8	Using Ambiguous Grammars. . . . .	278
4.8.1	Precedence and Associativity to Resolve Conflicts . . . . .	279
4.8.2	The "Dangling-Else" Ambiguity. . . . .	281
4.8.3	Error Recovery in LR Parsing . . . . .	283
4.8.4	Exercises for Section 4.8. . . . .	285
4.9	Parser Generators. . . . .	287
4.9.1	The Parser Generator <b>Yacc</b> . . . . .	287
4.9.2	Using <b>Yacc</b> with Ambiguous Grammars. . . . .	291
4.9.3	Creating <b>Yacc</b> Lexical Analyzers with <b>Lex</b> . . . . .	294
4.9.4	Error Recovery in <b>Yacc</b> . . . . .	295
4.9.5	Exercises for Section 4.9. . . . .	297
4.10	Summary of Chapter 4. . . . .	297
4.11	References for Chapter 4. . . . .	300

<b>5</b>	<b>Syntax-Directed Translation</b>	<b>303</b>
5.1	Syntax-Directed Definitions	304
5.1.1	Inherited and Synthesized Attributes	304
5.1.2	Evaluating an SDD at the Nodes of a Parse Tree	306
5.1.3	Exercises for Section 5.1	309
5.2	Evaluation Orders for SDD's	310
5.2.1	Dependency Graphs	310
5.2.2	Ordering the Evaluation of Attributes	312
5.2.3	S-Attributed Definitions	312
5.2.4	L-Attributed Definitions	313
5.2.5	Semantic Rules with Controlled Side Effects	314
5.2.6	Exercises for Section 5.2	317
5.3	Applications of Syntax-Directed Translation	318
5.3.1	Construction of Syntax Trees	318
5.3.2	The Structure of a Type	321
5.3.3	Exercises for Section 5.3	323
5.4	Syntax-Directed Translation Schemes	324
5.4.1	Postfix Translation Schemes	324
5.4.2	Parser-Stack Implementation of Postfix SDT's	325
5.4.3	SDT's With Actions Inside Productions	327
5.4.4	Eliminating Left Recursion From SDT's	328
5.4.5	SDT's for L-Attributed Definitions	331
5.4.6	Exercises for Section 5.4	336
5.5	Implementing L-Attributed SDD's	337
5.5.1	Translation During Recursive-Descent Parsing	338
5.5.2	On-The-Fly Code Generation	340
5.5.3	L-Attributed SDD's and LL Parsing	343
5.5.4	Bottom-Up Parsing of L-Attributed SDD's	348
5.5.5	Exercises for Section 5.5	352
5.6	Summary of Chapter 5	353
5.7	References for Chapter 5	354
<b>6</b>	<b>Intermediate-Code Generation</b>	<b>357</b>
6.1	Variants of Syntax Trees	358
6.1.1	Directed Acyclic Graphs for Expressions	359
6.1.2	The Value-Number Method for Constructing DAG's	360
6.1.3	Exercises for Section 6.1	362
6.2	Three-Address Code	363
6.2.1	Addresses and Instructions	364
6.2.2	Quadruples	366
6.2.3	Triples	367
6.2.4	Static Single-Assignment Form	369
6.2.5	Exercises for Section 6.2	370
6.3	Types and Declarations	370
6.3.1	Type Expressions	371

6.3.2	Type Equivalence. . . . .	372
6.3.3	Declarations . . . . .	373
6.3.4	Storage Layout for Local Names. . . . .	373
6.3.5	Sequences of Declarations. . . . .	376
6.3.6	Fields in Records and Classes. . . . .	376
6.3.7	Exercises for Section 6.3. . . . .	378
6.4	Translation of Expressions. . . . .	378
6.4.1	Operations Within Expressions. . . . .	378
6.4.2	Incremental Translation . . . . .	380
6.4.3	Addressing Array Elements. . . . .	381
6.4.4	Translation of Array References. . . . .	383
6.4.5	Exercises for Section 6.4. . . . .	384
6.5	Type Checking . . . . .	386
6.5.1	Rules for Type Checking . . . . .	387
6.5.2	Type Conversions. . . . .	388
6.5.3	Overloading of Functions and Operators. . . . .	390
6.5.4	Type Inference and Polymorphic Functions. . . . .	391
6.5.5	An Algorithm for Unification. . . . .	395
6.5.6	Exercises for Section 6.5. . . . .	398
6.6	Control Flow. . . . .	399
6.6.1	Boolean Expressions. . . . .	399
6.6.2	Short-Circuit Code. . . . .	400
6.6.3	Flow-of-Control Statements . . . . .	401
6.6.4	Control-Flow Translation of Boolean Expressions . . . . .	403
6.6.5	Avoiding Redundant Gotos. . . . .	405
6.6.6	Boolean Values and Jumping Code. . . . .	408
6.6.7	Exercises for Section 6.6. . . . .	408
6.7	Backpatching. . . . .	410
6.7.1	One-Pass Code Generation Using Backpatching . . . . .	410
6.7.2	Backpatching for Boolean Expressions. . . . .	411
6.7.3	Flow-of-Control Statements . . . . .	413
6.7.4	Break-, Continue-, and Goto-Statements. . . . .	416
6.7.5	Exercises for Section 6.7. . . . .	417
6.8	Switch-Statements . . . . .	418
6.8.1	Translation of Switch-Statements. . . . .	419
6.8.2	Syntax-Directed Translation of Switch-Statements . . . . .	420
6.8.3	Exercises for Section 6.8. . . . .	421
6.9	Intermediate Code for Procedures. . . . .	422
6.10	Summary of Chapter 6. . . . .	424
6.11	References for Chapter 6. . . . .	425

<b>7</b>	<b>Run-Time Environments</b>	<b>427</b>
7.1	Storage Organization	427
7.1.1	Static Versus Dynamic Storage Allocation	429
7.2	Stack Allocation of Space	430
7.2.1	Activation Trees	430
7.2.2	Activation Records	433
7.2.3	Calling Sequences	436
7.2.4	Variable-Length Data on the Stack	438
7.2.5	Exercises for Section 7.2	440
7.3	Access to Nonlocal Data on the Stack	441
7.3.1	Data Access Without Nested Procedures	442
7.3.2	Issues With Nested Procedures	442
7.3.3	A Language With Nested Procedure Declarations	443
7.3.4	Nesting Depth	443
7.3.5	Access Links	445
7.3.6	Manipulating Access Links	447
7.3.7	Access Links for Procedure Parameters	448
7.3.8	Displays	449
7.3.9	Exercises for Section 7.3	451
7.4	Heap Management	452
7.4.1	The Memory Manager	453
7.4.2	The Memory Hierarchy of a Computer	454
7.4.3	Locality in Programs	455
7.4.4	Reducing Fragmentation	457
7.4.5	Manual Deallocation Requests	460
7.4.6	Exercises for Section 7.4	463
7.5	Introduction to Garbage Collection	463
7.5.1	Design Goals for Garbage Collectors	464
7.5.2	Reachability	466
7.5.3	Reference Counting Garbage Collectors	468
7.5.4	Exercises for Section 7.5	470
7.6	Introduction to Trace-Based Collection	470
7.6.1	A Basic Mark-and-Sweep Collector	471
7.6.2	Basic Abstraction	473
7.6.3	Optimizing Mark-and-Sweep	475
7.6.4	Mark-and-Compact Garbage Collectors	476
7.6.5	Copying collectors	478
7.6.6	Comparing Costs	482
7.6.7	Exercises for Section 7.6	482
7.7	Short-Pause Garbage Collection	483
7.7.1	Incremental Garbage Collection	483
7.7.2	Incremental Reachability Analysis	485
7.7.3	Partial-Collection Basics	487
7.7.4	Generational Garbage Collection	488
7.7.5	The Train Algorithm	490

7.7.6	Exercises for Section 7.7 . . . . .	493
7.8	Advanced Topics in Garbage Collection . . . . .	494
7.8.1	Parallel and Concurrent Garbage Collection . . . . .	495
7.8.2	Partial Object Relocation . . . . .	497
7.8.3	Conservative Collection for Unsafe Languages . . . . .	498
7.8.4	Weak References . . . . .	498
7.8.5	Exercises for Section 7.8 . . . . .	499
7.9	Summary of Chapter 7 . . . . .	500
7.10	References for Chapter 7 . . . . .	502
<b>8</b>	<b>Code Generation</b> . . . . .	<b>505</b>
8.1	Issues in the Design of a Code Generator . . . . .	506
8.1.1	Input to the Code Generator . . . . .	507
8.1.2	The Target Program . . . . .	507
8.1.3	Instruction Selection . . . . .	508
8.1.4	Register Allocation . . . . .	510
8.1.5	Evaluation Order . . . . .	511
8.2	The Target Language . . . . .	512
8.2.1	A Simple Target Machine Model . . . . .	512
8.2.2	Program and Instruction Costs . . . . .	515
8.2.3	Exercises for Section 8.2 . . . . .	516
8.3	Addresses in the Target Code . . . . .	518
8.3.1	Static Allocation . . . . .	518
8.3.2	Stack Allocation . . . . .	520
8.3.3	Run-Time Addresses for Names . . . . .	522
8.3.4	Exercises for Section 8.3 . . . . .	524
8.4	Basic Blocks and Flow Graphs . . . . .	525
8.4.1	Basic Blocks . . . . .	526
8.4.2	Next-Use Information . . . . .	528
8.4.3	Flow Graphs . . . . .	529
8.4.4	Representation of Flow Graphs . . . . .	530
8.4.5	Loops . . . . .	531
8.4.6	Exercises for Section 8.4 . . . . .	531
8.5	Optimization of Basic Blocks . . . . .	533
8.5.1	The DAG Representation of Basic Blocks . . . . .	533
8.5.2	Finding Local Common Subexpressions . . . . .	534
8.5.3	Dead Code Elimination . . . . .	535
8.5.4	The Use of Algebraic Identities . . . . .	536
8.5.5	Representation of Array References . . . . .	537
8.5.6	Pointer Assignments and Procedure Calls . . . . .	539
8.5.7	Reassembling Basic Blocks From DAG's . . . . .	539
8.5.8	Exercises for Section 8.5 . . . . .	541
8.6	A Simple Code Generator . . . . .	542
8.6.1	Register and Address Descriptors . . . . .	543
8.6.2	The Code-Generation Algorithm . . . . .	544



8.6.3	Design of the Function <i>getReg</i> . . . . .	547
8.6.4	Exercises for Section 8.6 . . . . .	548
8.7	Peephole Optimization . . . . .	549
8.7.1	Eliminating Redundant Loads and Stores . . . . .	550
8.7.2	Eliminating Unreachable Code . . . . .	550
8.7.3	Flow-of-Control Optimizations . . . . .	551
8.7.4	Algebraic Simplification and Reduction in Strength . . . . .	552
8.7.5	Use of Machine Idioms . . . . .	552
8.7.6	Exercises for Section 8.7 . . . . .	553
8.8	Register Allocation and Assignment . . . . .	553
8.8.1	Global Register Allocation . . . . .	553
8.8.2	Usage Counts . . . . .	554
8.8.3	Register Assignment for Outer Loops . . . . .	556
8.8.4	Register Allocation by Graph Coloring . . . . .	556
8.8.5	Exercises for Section 8.8 . . . . .	557
8.9	Instruction Selection by Tree Rewriting . . . . .	558
8.9.1	Tree-Translation Schemes . . . . .	558
8.9.2	Code Generation by Tiling an Input Tree . . . . .	560
8.9.3	Pattern Matching by Parsing . . . . .	563
8.9.4	Routines for Semantic Checking . . . . .	565
8.9.5	General Tree Matching . . . . .	565
8.9.6	Exercises for Section 8.9 . . . . .	567
8.10	Optimal Code Generation for Expressions . . . . .	567
8.10.1	Ershov Numbers . . . . .	567
8.10.2	Generating Code From Labeled Expression Trees . . . . .	568
8.10.3	Evaluating Expressions with an Insufficient Supply of Reg- isters . . . . .	570
8.10.4	Exercises for Section 8.10 . . . . .	572
8.11	Dynamic Programming Code-Generation . . . . .	573
8.11.1	Contiguous Evaluation . . . . .	574
8.11.2	The Dynamic Programming Algorithm . . . . .	575
8.11.3	Exercises for Section 8.11 . . . . .	577
8.12	Summary of Chapter 8 . . . . .	578
8.13	References for Chapter 8 . . . . .	579
<b>9</b>	<b>Machine-Independent Optimizations</b> . . . . .	<b>583</b>
9.1	The Principal Sources of Optimization . . . . .	584
9.1.1	Causes of Redundancy . . . . .	584
9.1.2	A Running Example: Quicksort . . . . .	585
9.1.3	Semantics-Preserving Transformations . . . . .	586
9.1.4	Global Common Subexpressions . . . . .	588
9.1.5	Copy Propagation . . . . .	590
9.1.6	Dead-Code Elimination . . . . .	591
9.1.7	Code Motion . . . . .	592
9.1.8	Induction Variables and Reduction in Strength . . . . .	592

9.1.9	Exercises for Section 9.1. . . . .	596
9.2	Introduction to Data-Flow Analysis. . . . .	597
9.2.1	The Data-Flow Abstraction . . . . .	597
9.2.2	The Data-Flow Analysis Schema . . . . .	599
9.2.3	Data-Flow Schemas on Basic Blocks. . . . .	600
9.2.4	Reaching Definitions. . . . .	601
9.2.5	Live-Variable Analysis. . . . .	608
9.2.6	Available Expressions. . . . .	610
9.2.7	Summary. . . . .	614
9.2.8	Exercises for Section 9.2. . . . .	615
9.3	Foundations of Data-Flow Analysis. . . . .	618
9.3.1	Semilattices. . . . .	618
9.3.2	Transfer Functions . . . . .	623
9.3.3	The Iterative Algorithm for General Frameworks . . . . .	626
9.3.4	Meaning of a Data-Flow Solution. . . . .	628
9.3.5	Exercises for Section 9.3. . . . .	631
9.4	Constant Propagation. . . . .	632
9.4.1	Data-Flow Values for the Constant-Propagation Framework . . . . .	633
9.4.2	The Meet for the Constant-Propagation Framework . . . . .	633
9.4.3	Transfer Functions for the Constant-Propagation Framework . . . . .	634
9.4.4	Monotonicity of the Constant-Propagation Framework . . . . .	635
9.4.5	Nondistributivity of the Constant-Propagation Framework . . . . .	635
9.4.6	Interpretation of the Results. . . . .	637
9.4.7	Exercises for Section 9.4. . . . .	637
9.5	Partial-Redundancy Elimination. . . . .	639
9.5.1	The Sources of Redundancy. . . . .	639
9.5.2	Can All Redundancy Be Eliminated?. . . . .	642
9.5.3	The Lazy-Code-Motion Problem . . . . .	644
9.5.4	Anticipation of Expressions. . . . .	645
9.5.5	The Lazy-Code-Motion Algorithm. . . . .	646
9.5.6	Exercises for Section 9.5. . . . .	655
9.6	Loops in Flow Graphs. . . . .	655
9.6.1	Dominators. . . . .	656
9.6.2	Depth-First Ordering . . . . .	660
9.6.3	Edges in a Depth-First Spanning Tree. . . . .	661
9.6.4	Back Edges and Reducibility. . . . .	662
9.6.5	Depth of a Flow Graph . . . . .	665
9.6.6	Natural Loops. . . . .	665
9.6.7	Speed of Convergence of Iterative Data-Flow Algorithms . . . . .	667
9.6.8	Exercises for Section 9.6. . . . .	669
9.7	Region-Based Analysis. . . . .	672
9.7.1	Regions. . . . .	672
9.7.2	Region Hierarchies for Reducible Flow Graphs. . . . .	673

9.7.3	Overview of a Region-Based Analysis . . . . .	676
9.7.4	Necessary Assumptions About Transfer Functions . . . . .	678
9.7.5	An Algorithm for Region-Based Analysis . . . . .	680
9.7.6	Handling Nonreducible Flow Graphs . . . . .	684
9.7.7	Exercises for Section 9.7. . . . .	686
9.8	Symbolic Analysis . . . . .	686
9.8.1	Affine Expressions of Reference Variables . . . . .	687
9.8.2	Data-Flow Problem Formulation . . . . .	689
9.8.3	Region-Based Symbolic Analysis . . . . .	694
9.8.4	Exercises for Section 9.8. . . . .	699
9.9	Summary of Chapter 9 . . . . .	700
9.10	References for Chapter 9. . . . .	703
<b>10</b>	<b>Instruction-Level Parallelism</b> . . . . .	<b>707</b>
10.1	Processor Architectures . . . . .	708
10.1.1	Instruction Pipelines and Branch Delays . . . . .	708
10.1.2	Pipelined Execution . . . . .	709
10.1.3	Multiple Instruction Issue . . . . .	710
10.2	Code-Scheduling Constraints . . . . .	710
10.2.1	Data Dependence . . . . .	711
10.2.2	Finding Dependences Among Memory Accesses . . . . .	712
10.2.3	Tradeoff Between Register Usage and Parallelism . . . . .	713
10.2.4	Phase Ordering Between Register Allocation and Code Scheduling . . . . .	716
10.2.5	Control Dependence . . . . .	716
10.2.6	Speculative Execution Support . . . . .	717
10.2.7	A Basic Machine Model . . . . .	719
10.2.8	Exercises for Section 10.2. . . . .	720
10.3	Basic-Block Scheduling . . . . .	721
10.3.1	Data-Dependence Graphs . . . . .	722
10.3.2	List Scheduling of Basic Blocks . . . . .	723
10.3.3	Prioritized Topological Orders . . . . .	725
10.3.4	Exercises for Section 10.3. . . . .	726
10.4	Global Code Scheduling . . . . .	727
10.4.1	Primitive Code Motion . . . . .	728
10.4.2	Upward Code Motion . . . . .	730
10.4.3	Downward Code Motion . . . . .	731
10.4.4	Updating Data Dependences . . . . .	732
10.4.5	Global Scheduling Algorithms . . . . .	732
10.4.6	Advanced Code Motion Techniques . . . . .	736
10.4.7	Interaction with Dynamic Schedulers . . . . .	737
10.4.8	Exercises for Section 10.4. . . . .	737
10.5	Software Pipelining . . . . .	738
10.5.1	Introduction . . . . .	738
10.5.2	Software Pipelining of Loops . . . . .	740

10.5.3 Register Allocation and Code Generation . . . . .	743
10.5.4 Do-Across Loops . . . . .	743
10.5.5 Goals and Constraints of Software Pipelining . . . . .	745
10.5.6 A Software-Pipelining Algorithm . . . . .	749
10.5.7 Scheduling Acyclic Data-Dependence Graphs . . . . .	749
10.5.8 Scheduling Cyclic Dependence Graphs . . . . .	751
10.5.9 Improvements to the Pipelining Algorithms . . . . .	758
10.5.10 Modular Variable Expansion . . . . .	758
10.5.11 Conditional Statements . . . . .	761
10.5.12 Hardware Support for Software Pipelining . . . . .	762
10.5.13 Exercises for Section 10.5 . . . . .	763
10.6 Summary of Chapter 10 . . . . .	765
10.7 References for Chapter 10 . . . . .	766
<b>11 Optimizing for Parallelism and Locality</b> . . . . .	<b>769</b>
11.1 Basic Concepts . . . . .	771
11.1.1 Multiprocessors . . . . .	772
11.1.2 Parallelism in Applications . . . . .	773
11.1.3 Loop-Level Parallelism . . . . .	775
11.1.4 Data Locality . . . . .	777
11.1.5 Introduction to Affine Transform Theory . . . . .	778
11.2 Matrix Multiply: An In-Depth Example . . . . .	782
11.2.1 The Matrix-Multiplication Algorithm . . . . .	782
11.2.2 Optimizations . . . . .	785
11.2.3 Cache Interference . . . . .	788
11.2.4 Exercises for Section 11.2 . . . . .	788
11.3 Iteration Spaces . . . . .	788
11.3.1 Constructing Iteration Spaces from Loop Nests . . . . .	788
11.3.2 Execution Order for Loop Nests . . . . .	791
11.3.3 Matrix Formulation of Inequalities . . . . .	791
11.3.4 Incorporating Symbolic Constants . . . . .	793
11.3.5 Controlling the Order of Execution . . . . .	793
11.3.6 Changing Axes . . . . .	798
11.3.7 Exercises for Section 11.3 . . . . .	799
11.4 Affine Array Indexes . . . . .	801
11.4.1 Affine Accesses . . . . .	802
11.4.2 Affine and Nonaffine Accesses in Practice . . . . .	803
11.4.3 Exercises for Section 11.4 . . . . .	804
11.5 Data Reuse . . . . .	804
11.5.1 Types of Reuse . . . . .	805
11.5.2 Self Reuse . . . . .	806
11.5.3 Self-Spatial Reuse . . . . .	809
11.5.4 Group Reuse . . . . .	811
11.5.5 Exercises for Section 11.5 . . . . .	814
11.6 Array Data-Dependence Analysis . . . . .	815

11.6.1	Definition of Data Dependence of Array Accesses . . . . .	816
11.6.2	Integer Linear Programming . . . . .	817
11.6.3	The GCD Test . . . . .	818
11.6.4	Heuristics for Solving Integer Linear Programs . . . . .	820
11.6.5	Solving General Integer Linear Programs . . . . .	823
11.6.6	Summary. . . . .	825
11.6.7	Exercises for Section 11.6 . . . . .	826
11.7	Finding Synchronization-Free Parallelism . . . . .	828
11.7.1	An Introductory Example . . . . .	828
11.7.2	Affine Space Partitions. . . . .	830
11.7.3	Space-Partition Constraints. . . . .	831
11.7.4	Solving Space-Partition Constraints . . . . .	835
11.7.5	A Simple Code-Generation Algorithm . . . . .	838
11.7.6	Eliminating Empty Iterations. . . . .	841
11.7.7	Eliminating Tests from Innermost Loops. . . . .	844
11.7.8	Source-Code Transforms . . . . .	846
11.7.9	Exercises for Section 11.7. . . . .	851
11.8	Synchronization Between Parallel Loops . . . . .	853
11.8.1	A Constant Number of Synchronizations. . . . .	853
11.8.2	Program-Dependence Graphs. . . . .	854
11.8.3	Hierarchical Time. . . . .	857
11.8.4	The Parallelization Algorithm. . . . .	859
11.8.5	Exercises for Section 11.8. . . . .	860
11.9	Pipelining. . . . .	861
11.9.1	What is Pipelining?. . . . .	861
11.9.2	Successive Over-Relaxation (SOR): An Example. . . . .	863
11.9.3	Fully Permutable Loops. . . . .	864
11.9.4	Pipelining Fully Permutable Loops. . . . .	864
11.9.5	General Theory. . . . .	867
11.9.6	Time-Partition Constraints . . . . .	868
11.9.7	Solving Time-Partition Constraints by Farkas' Lemma . . . . .	872
11.9.8	Code Transformations . . . . .	875
11.9.9	Parallelism With Minimum Synchronization. . . . .	880
11.9.10	Exercises for Section 11.9. . . . .	882
11.10	Locality Optimizations. . . . .	884
11.10.1	Temporal Locality of Computed Data . . . . .	885
11.10.2	Array Contraction . . . . .	885
11.10.3	Partition Interleaving . . . . .	887
11.10.4	Putting it All Together. . . . .	890
11.10.5	Exercises for Section 11.10. . . . .	892
11.11	Other Uses of Affine Transforms. . . . .	893
11.11.1	Distributed memory machines. . . . .	894
11.11.2	Multi-Instruction-Issue Processors. . . . .	895
11.11.3	Vector and SIMD Instructions . . . . .	895
11.11.4	Prefetching. . . . .	896

TABLE OF CONTENTS

11.12 Summary of Chapter 11. . . . .	897
11.13 References for Chapter 11. . . . .	899
<b>12 Interprocedural Analysis</b>	<b>903</b>
12.1 Basic Concepts . . . . .	904
12.1.1 Call Graphs. . . . .	904
12.1.2 Context Sensitivity. . . . .	906
12.1.3 Call Strings. . . . .	908
12.1.4 Cloning-Based Context-Sensitive Analysis. . . . .	910
12.1.5 Summary-Based Context-Sensitive Analysis. . . . .	911
12.1.6 Exercises for Section 12.1. . . . .	914
12.2 Why Interprocedural Analysis?. . . . .	916
12.2.1 Virtual Method Invocation . . . . .	916
12.2.2 Pointer Alias Analysis. . . . .	917
12.2.3 Parallelization. . . . .	917
12.2.4 Detection of Software Errors and Vulnerabilities . . . . .	917
12.2.5 SQL Injection. . . . .	918
12.2.6 Buffer Overflow. . . . .	920
12.3 A Logical Representation of Data Flow. . . . .	921
12.3.1 Introduction to Datalog . . . . .	921
12.3.2 Datalog Rules . . . . .	922
12.3.3 Intensional and Extensional Predicates. . . . .	924
12.3.4 Execution of Datalog Programs. . . . .	927
12.3.5 Incremental Evaluation of Datalog Programs. . . . .	928
12.3.6 Problematic Datalog Rules. . . . .	930
12.3.7 Exercises for Section 12.3. . . . .	932
12.4 A Simple Pointer-Analysis Algorithm. . . . .	933
12.4.1 Why is Pointer Analysis Difficult . . . . .	934
12.4.2 A Model for Pointers and References. . . . .	935
12.4.3 Flow Insensitivity. . . . .	936
12.4.4 The Formulation in Datalog . . . . .	937
12.4.5 Using Type Information. . . . .	938
12.4.6 Exercises for Section 12.4. . . . .	939
12.5 Context-Insensitive Interprocedural Analysis. . . . .	941
12.5.1 Effects of a Method Invocation. . . . .	941
12.5.2 Call Graph Discovery in Datalog . . . . .	943
12.5.3 Dynamic Loading and Reflection. . . . .	944
12.5.4 Exercises for Section 12.5. . . . .	945
12.6 Context-Sensitive Pointer Analysis. . . . .	945
12.6.1 Contexts and Call Strings . . . . .	946
12.6.2 Adding Context to Datalog Rules. . . . .	949
12.6.3 Additional Observations About Sensitivity. . . . .	949
12.6.4 Exercises for Section 12.6. . . . .	950
12.7 Datalog Implementation by BDD's . . . . .	951
12.7.1 Binary Decision Diagrams. . . . .	951

12.7.2	Transformations on BDD's . . . . .	953
12.7.3	Representing Relations by BDD's . . . . .	954
12.7A	Relational Operations as BDD Operations . . . . .	954
12.7.5	Using BDD's for Points-to Analysis . . . . .	957
12.7.6	Exercises for Section 12.7. . . . .	958
12.8	Summary of Chapter 12. . . . .	958
12.9	References for Chapter 12. . . . .	961
<b>A</b>	<b>A Complete Front End</b>	<b>965</b>
A.1	The Source Language. . . . .	965
A.2	Main . . . . .	966
A.3	Lexical Analyzer. . . . .	967
A.4	Symbol Tables and Types. . . . .	970
A.5	Intermediate Code for Expressions. . . . .	971
A.6	Jumping Code for Boolean Expressions. . . . .	974
A.7	Intermediate Code for Statements. . . . .	978
A.8	Parser. . . . .	981
A.9	Creating the Front End . . . . .	986
<b>B</b>	<b>Finding Linearly Independent Solutions</b>	<b>989</b>
	<b>Index</b>	<b>993</b>

# Chapter 1

## Introduction

Programming languages are notations for describing computations to people and to machines. The world as we know it depends on programming languages, because all the software running on all the computers was written in some programming language. But, before a program can be run, it first must be translated into a form in which it can be executed by a computer.

The software systems that do this translation are called *compilers*.

This book is about how to design and implement compilers. We shall discover that a few basic ideas can be used to construct translators for a wide variety of languages and machines. Besides compilers, the principles and techniques for compiler design are applicable to so many other domains that they are likely to be reused many times in the career of a computer scientist. The study of compiler writing touches upon programming languages, machine architecture, language theory, algorithms, and software engineering.

In this preliminary chapter, we introduce the different forms of language translators, give a high level overview of the structure of a typical compiler, and discuss the trends in programming languages and machine architecture that are shaping compilers. We include some observations on the relationship between compiler design and computer-science theory and an outline of the applications of compiler technology that go beyond compilation. We end with a brief outline of key programming-language concepts that will be needed for our study of compilers.

### 1.1 Language Processors

Simply stated, a compiler is a program that can read a program in one language — the *source* language — and translate it into an equivalent program in another language — the *target* language; see Fig. 1.1. An important role of the compiler is to report any errors in the source program that it detects during the translation process.



source program

Compiler

target program

Figure 1.1: A compiler

If the target program is an executable machine-language program, it can then be called by the user to process inputs and produce outputs; see Fig. 1.2.

input      Target Program      output

Figure 1.2: Running the target program

An *interpreter* is another common kind of language processor. Instead of producing a target program as a translation, an interpreter appears to directly execute the operations specified in the source program on inputs supplied by the user, as shown in Fig. 1.3.

source program      Interpreter      output  
input

Figure 1.3: An interpreter

The machine-language target program produced by a compiler is usually much faster than an interpreter at mapping inputs to outputs. An interpreter, however, can usually give better error diagnostics than a compiler, because it executes the source program statement by statement.

**Example 1.1:** Java language processors combine compilation and interpretation, as shown in Fig. 1.4. A Java source program may first be compiled into an intermediate form called *bytecodes*. The bytecodes are then interpreted by a virtual machine. A benefit of this arrangement is that bytecodes compiled on one machine can be interpreted on another machine, perhaps across a network.

In order to achieve faster processing of inputs to outputs, some Java compilers, called *just-in-time* compilers, translate the bytecodes into machine language immediately before they run the intermediate program to process the input. •

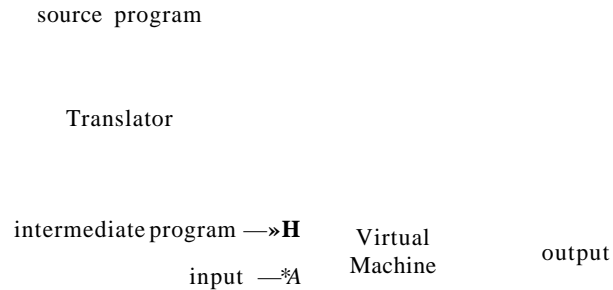

Figure 1.4: A hybrid compiler

In addition to a compiler, several other programs may be required to create an executable target program, as shown in Fig. 1.5. A source program may be divided into modules stored in separate files. The task of collecting the source program is sometimes entrusted to a separate program, called a *preprocessor*. The preprocessor may also expand shorthands, called macros, into source language statements.

The modified source program is then fed to a compiler. The compiler may produce an assembly-language program as its output, because assembly language is easier to produce as output and is easier to debug. The assembly language is then processed by a program called an *assembler* that produces relocatable machine code as its output.

Large programs are often compiled in pieces, so the relocatable machine code may have to be linked together with other relocatable object files and library files into the code that actually runs on the machine. The *linker* resolves external memory addresses, where the code in one file may refer to a location in another file. The *loader* then puts together all of the executable object files into memory for execution.

### 1.1.1 Exercises for Section 1.1

**Exercise 1.1.1:** What is the difference between a compiler and an interpreter?

**Exercise 1.1.2:** What are the advantages of (a) a compiler over an interpreter (b) an interpreter over a compiler?

**Exercise 1.1.3 :** What advantages are there to a language-processing system in which the compiler produces assembly language rather than machine language?

**Exercise 1.1.4:** A compiler that translates a high-level language into another high-level language is called a *source-to-source* translator. What advantages are there to using C as a target language for a compiler?

**Exercise 1.1.5:** Describe some of the tasks that an assembler needs to perform.

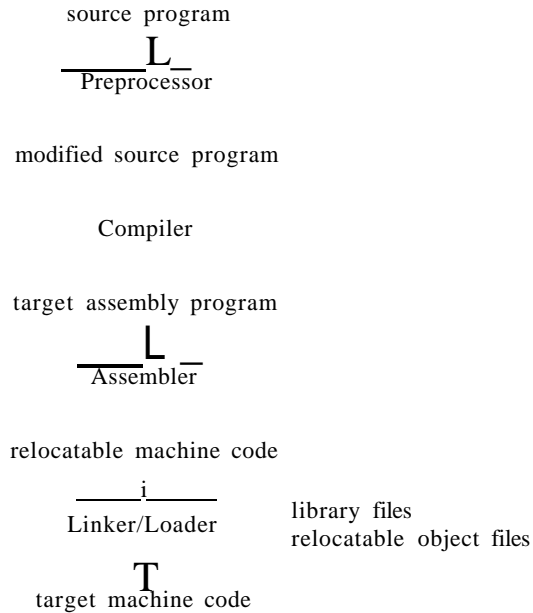

Figure 1.5: A language-processing system

## 1.2 The Structure of a Compiler

Up to this point we have treated a compiler as a single box that maps a source program into a semantically equivalent target program. If we open up this box a little, we see that there are two parts to this mapping: analysis and synthesis.

The *analysis* part breaks up the source program into constituent pieces and imposes a grammatical structure on them. It then uses this structure to create an intermediate representation of the source program. If the analysis part detects that the source program is either syntactically ill formed or semantically unsound, then it must provide informative messages, so the user can take corrective action. The analysis part also collects information about the source program and stores it in a data structure called a *symbol table*, which is passed along with the intermediate representation to the synthesis part.

The *synthesis* part constructs the desired target program from the intermediate representation and the information in the symbol table. The analysis part is often called the *front end* of the compiler; the synthesis part is the *back end*.

If we examine the compilation process in more detail, we see that it operates as a sequence of *phases*, each of which transforms one representation of the source program to another. A typical decomposition of a compiler into phases is shown in Fig. 1.6. In practice, several phases may be grouped together, and the intermediate representations between the grouped phases need not be constructed explicitly. The symbol table, which stores information about the

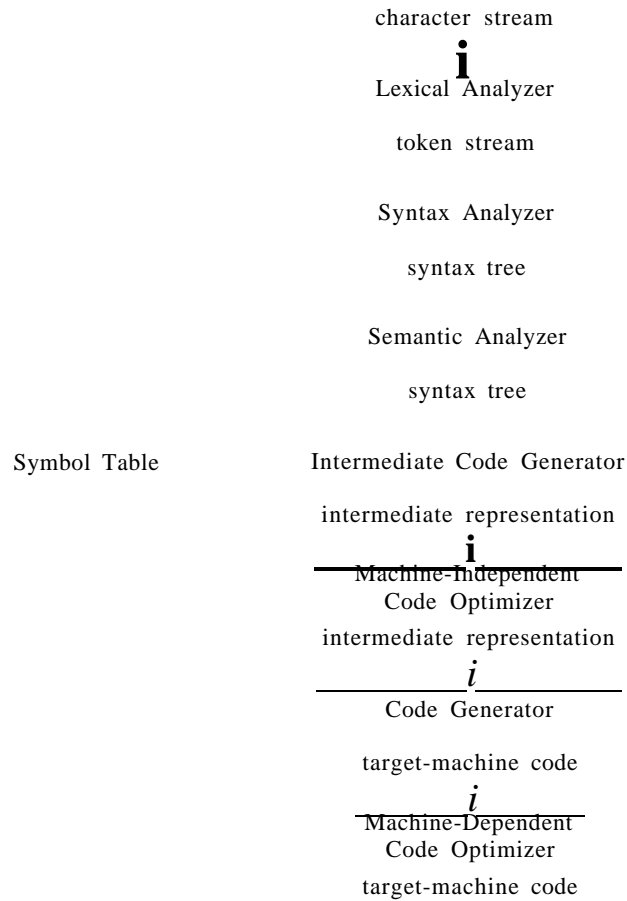

Figure 1.6: Phases of a compiler

entire source program, is used by all phases of the compiler.

Some compilers have a machine-independent optimization phase between the front end and the back end. The purpose of this optimization phase is to perform transformations on the intermediate representation, so that the back end can produce a better target program than it would have otherwise produced from an unoptimized intermediate representation. Since optimization is optional, one or the other of the two optimization phases shown in Fig. 1.6 may be missing.

### 1.2.1 Lexical Analysis

The first phase of a compiler is called *lexical analysis* or *scanning*. The lexical analyzer reads the stream of characters making up the source program

and groups the characters into meaningful sequences called *lexemes*. For each lexeme, the lexical analyzer produces as output a *token* of the form

$$(token-name, \quad attribute-value)$$

that it passes on to the subsequent phase, syntax analysis. In the token, the first component *token-name* is an abstract symbol that is used during syntax analysis, and the second component *attribute-value* points to an entry in the symbol table for this token. Information from the symbol-table entry is needed for semantic analysis and code generation.

For example, suppose a source program contains the assignment statement

$$position = initial + rate * 60 \quad (1.1)$$

The characters in this assignment could be grouped into the following lexemes and mapped into the following tokens passed on to the syntax analyzer:

1. `position` is a lexeme that would be mapped into a token **(id, 1)**, where **id** is an abstract symbol standing for *identifier* and 1 points to the symbol-table entry for `position`. The symbol-table entry for an identifier holds information about the identifier, such as its name and type.
2. The assignment symbol `=` is a lexeme that is mapped into the token **(=)**. Since this token needs no attribute-value, we have omitted the second component. We could have used any abstract symbol such as **assign** for the token-name, but for notational convenience we have chosen to use the lexeme itself as the name of the abstract symbol.
3. `initial` is a lexeme that is mapped into the token **(id, 2)**, where 2 points to the symbol-table entry for `initial`.
4. `+` is a lexeme that is mapped into the token **(+)**.
5. `rate` is a lexeme that is mapped into the token **(id, 3)**, where 3 points to the symbol-table entry for `rate`.
6. `*` is a lexeme that is mapped into the token **(\*)**.
7. `60` is a lexeme that is mapped into the token **(60)**.<sup>1</sup>

Blanks separating the lexemes would be discarded by the lexical analyzer.

Figure 1.7 shows the representation of the assignment statement (1.1) after lexical analysis as the sequence of tokens

$$\mathbf{(id,1)} \ \mathbf{<=>} \ \mathbf{(id, 2)} \ \mathbf{(+)} \ \mathbf{(id, 3)} \ \mathbf{(*)} \ \mathbf{(60)} \quad (1.2)$$

In this representation, the token names `=`, `+`, and `*` are abstract symbols for the assignment, addition, and multiplication operators, respectively.

<sup>1</sup>Technically speaking, for the lexeme `60` we should make up a token like **(number, 4)**, where 4 points to the symbol table for the internal representation of integer 60 but we shall defer the discussion of tokens for numbers until Chapter 2. Chapter 3 discusses techniques for building lexical analyzers.

THE STRUCTURE OF A COMPILER

position = initial + rate \* 60

**i**  
-----  
Lexical Analyzer

(id,1) (=) <id,2> (<+>) <id,3> (<\*>) (<60>)

\*  
-----  
Syntax Analyzer

<id,1> +  
(id,2) -  
          (id,3)           60

Semantic Analyzer

(id,1)  
      (id,2)  
          (id,3)       **inttfloat**  
                          |  
                          60

Intermediate Code Generator

```
t1 = inttfloat(60)
t2 = id3 * t1
t3 = id2 + t2
id1 = t3
```

**i**  
-----  
Code Optimizer

```
t1 = id3 * 60.0
id1 = id2 + t1
```

**i**  
-----  
Code Generator

```
LDF R2, id3
MULF R2, R2, #60.0
LDF R1, id2
ADDF R1, R1, R2
STF id1, R1
```

position	
initial	
rate	

SYMBOL TABLE

Figure 1.7: Translation of an assignment statement

### 1.2.2 Syntax Analysis

The second phase of the compiler is *syntax analysis* or *parsing*. The parser uses the first components of the tokens produced by the lexical analyzer to create a tree-like intermediate representation that depicts the grammatical structure of the token stream. A typical representation is a *syntax tree* in which each interior node represents an operation and the children of the node represent the arguments of the operation. A syntax tree for the token stream (1.2) is shown as the output of the syntactic analyzer in Fig. 1.7.

This tree shows the order in which the operations in the assignment

$$\text{position} = \text{initial} + \text{rate} * 60$$

are to be performed. The tree has an interior node labeled `*` with `(id, 3)` as its left child and the integer `60` as its right child. The node `(id, 3)` represents the identifier `rate`. The node labeled `*` makes it explicit that we must first multiply the value of `rate` by `60`. The node labeled `+` indicates that we must add the result of this multiplication to the value of `initial`. The root of the tree, labeled `=`, indicates that we must store the result of this addition into the location for the identifier `position`. This ordering of operations is consistent with the usual conventions of arithmetic which tell us that multiplication has higher precedence than addition, and hence that the multiplication is to be performed before the addition.

The subsequent phases of the compiler use the grammatical structure to help analyze the source program and generate the target program. In Chapter 4 we shall use context-free grammars to specify the grammatical structure of programming languages and discuss algorithms for constructing efficient syntax analyzers automatically from certain classes of grammars. In Chapters 2 and 5 we shall see that syntax-directed definitions can help specify the translation of programming language constructs.

### 1.2.3 Semantic Analysis

The *semantic analyzer* uses the syntax tree and the information in the symbol table to check the source program for semantic consistency with the language definition. It also gathers type information and saves it in either the syntax tree or the symbol table, for subsequent use during intermediate-code generation.

An important part of semantic analysis is *type checking*, where the compiler checks that each operator has matching operands. For example, many programming language definitions require an array index to be an integer; the compiler must report an error if a floating-point number is used to index an array.

The language specification may permit some type conversions called *coercions*. For example, a binary arithmetic operator may be applied to either a pair of integers or to a pair of floating-point numbers. If the operator is applied to a floating-point number and an integer, the compiler may convert or coerce the integer into a floating-point number.

Such a coercion appears in Fig. 1.7. Suppose that `position`, `initial`, and `rate` have been declared to be floating-point numbers, and that the lexeme `60` by itself forms an integer. The type checker in the semantic analyzer in Fig. 1.7 discovers that the operator `*` is applied to a floating-point number `rate` and an integer `60`. In this case, the integer may be converted into a floating-point number. In Fig. 1.7, notice that the output of the semantic analyzer has an extra node for the operator **inttfloat**, which explicitly converts its integer argument into a floating-point number. Type checking and semantic analysis are discussed in Chapter 6.

### 1.2.4 Intermediate Code Generation

In the process of translating a source program into target code, a compiler may construct one or more intermediate representations, which can have a variety of forms. Syntax trees are a form of intermediate representation; they are commonly used during syntax and semantic analysis.

After syntax and semantic analysis of the source program, many compilers generate an explicit low-level or machine-like intermediate representation, which we can think of as a program for an abstract machine. This intermediate representation should have two important properties: it should be easy to produce and it should be easy to translate into the target machine.

In Chapter 6, we consider an intermediate form called *three-address code*, which consists of a sequence of assembly-like instructions with three operands per instruction. Each operand can act like a register. The output of the intermediate code generator in Fig. 1.7 consists of the three-address code sequence

$$\begin{array}{l}
 t1 \bullet \text{inttfloat}(60) \\
 t2 \bullet\bullet \text{id3} * t1 \\
 \mathbf{ts} \bullet\bullet \text{id2} + t2 \\
 \text{id1} \quad t3
 \end{array}
 \tag{1.3}$$

There are several points worth noting about three-address instructions. First, each three-address assignment instruction has at most one operator on the right side. Thus, these instructions fix the order in which operations are to be done; the multiplication precedes the addition in the source program (1.1). Second, the compiler must generate a temporary name to hold the value computed by a three-address instruction. Third, some "three-address instructions" like the first and last in the sequence (1.3), above, have fewer than three operands.

In Chapter 6, we cover the principal intermediate representations used in compilers. Chapter 5 introduces techniques for syntax-directed translation that are applied in Chapter 6 to type checking and intermediate-code generation for typical programming language constructs such as expressions, flow-of-control constructs, and procedure calls.



## 1.2.5 Code Optimization

The machine-independent code-optimization phase attempts to improve the intermediate code so that better target code will result. Usually better means faster, but other objectives may be desired, such as shorter code, or target code that consumes less power. For example, a straightforward algorithm generates the intermediate code (1.3), using an instruction for each operator in the tree representation that comes from the semantic analyzer.

A simple intermediate code generation algorithm followed by code optimization is a reasonable way to generate good target code. The optimizer can deduce that the conversion of 60 from integer to floating point can be done once and for all at compile time, so the `inttofloat` operation can be eliminated by replacing the integer 60 by the floating-point number 60.0. Moreover, `t3` is used only once to transmit its value to `id1` so the optimizer can transform (1.3) into the shorter sequence

```
t1 = id3 * 60.0
id1 = id2 + t1
```

(1.4)

There is a great variation in the amount of code optimization different compilers perform. In those that do the most, the so-called "optimizing compilers," a significant amount of time is spent on this phase. There are simple optimizations that significantly improve the running time of the target program without slowing down compilation too much. The chapters from 8 on discuss machine-independent and machine-dependent optimizations in detail.

## 1.2.6 Code Generation

The code generator takes as input an intermediate representation of the source program and maps it into the target language. If the target language is machine code, registers or memory locations are selected for each of the variables used by the program. Then, the intermediate instructions are translated into sequences of machine instructions that perform the same task. A crucial aspect of code generation is the judicious assignment of registers to hold variables.

For example, using registers `R1` and `R2`, the intermediate code in (1.4) might get translated into the machine code

```
LDF R2, id3
MULF R2, R2, #60.0
LDF R1, id2
ADDF R1, R1, R2
STF id1, R1
```

(1.5)

The first operand of each instruction specifies a destination. The `F` in each instruction tells us that it deals with floating-point numbers. The code in

(1.5) loads the contents of address `id3` into register `R2`, then multiplies it with floating-point constant `60.0`. The `#` signifies that `60.0` is to be treated as an immediate constant. The third instruction moves `id2` into register `R1` and the fourth adds to it the value previously computed in register `R2`. Finally, the value in register `R1` is stored into the address of `id1`, so the code correctly implements the assignment statement (1.1). Chapter 8 covers code generation.

This discussion of code generation has ignored the important issue of storage allocation for the identifiers in the source program. As we shall see in Chapter 7, the organization of storage at run-time depends on the language being compiled. Storage-allocation decisions are made either during intermediate code generation or during code generation.

### 1.2.7 Symbol-Table Management

An essential function of a compiler is to record the variable names used in the source program and collect information about various attributes of each name. These attributes may provide information about the storage allocated for a name, its type, its scope (where in the program its value may be used), and in the case of procedure names, such things as the number and types of its arguments, the method of passing each argument (for example, by value or by reference), and the type returned.

The symbol table is a data structure containing a record for each variable name, with fields for the attributes of the name. The data structure should be designed to allow the compiler to find the record for each name quickly and to store or retrieve data from that record quickly. Symbol tables are discussed in Chapter 2.

### 1.2.8 The Grouping of Phases into Passes

The discussion of phases deals with the logical organization of a compiler. In an implementation, activities from several phases may be grouped together into a *pass* that reads an input file and writes an output file. For example, the front-end phases of lexical analysis, syntax analysis, semantic analysis, and intermediate code generation might be grouped together into one pass. Code optimization might be an optional pass. Then there could be a back-end pass consisting of code generation for a particular target machine.

Some compiler collections have been created around carefully designed intermediate representations that allow the front end for a particular language to interface with the back end for a certain target machine. With these collections, we can produce compilers for different source languages for one target machine by combining different front ends with the back end for that target machine. Similarly, we can produce compilers for different target machines, by combining a front end with back ends for different target machines.

### 1.2.9 Compiler-Construction Tools

The compiler writer, like any software developer, can profitably use modern software development environments containing tools such as language editors, debuggers, version managers, profilers, test harnesses, and so on. In addition to these general software-development tools, other more specialized tools have been created to help implement various phases of a compiler.

These tools use specialized languages for specifying and implementing specific components, and many use quite sophisticated algorithms. The most successful tools are those that hide the details of the generation algorithm and produce components that can be easily integrated into the remainder of the compiler. Some commonly used compiler-construction tools include

1. *Parser generators* that automatically produce syntax analyzers from a grammatical description of a programming language.
2. *Scanner generators* that produce lexical analyzers from a regular-expression description of the tokens of a language.
3. *Syntax-directed translation engines* that produce collections of routines for walking a parse tree and generating intermediate code.
4. *Code-generator generators* that produce a code generator from a collection of rules for translating each operation of the intermediate language into the machine language for a target machine.
5. *Data-flow analysis engines* that facilitate the gathering of information about how values are transmitted from one part of a program to each other part. Data-flow analysis is a key part of code optimization.
6. *Compiler-construction toolkits* that provide an integrated set of routines for constructing various phases of a compiler.

We shall describe many of these tools throughout this book.

## 1.3 The Evolution of Programming Languages

The first electronic computers appeared in the 1940's and were programmed in machine language by sequences of O's and 1's that explicitly told the computer what operations to execute and in what order. The operations themselves were very low level: move data from one location to another, add the contents of two registers, compare two values, and so on. Needless to say, this kind of programming was slow, tedious, and error prone. And once written, the programs were hard to understand and modify.

### 1.3.1 The Move to Higher-level Languages

The first step towards more people-friendly programming languages was the development of mnemonic assembly languages in the early 1950's. Initially, the instructions in an assembly language were just mnemonic representations of machine instructions. Later, macro instructions were added to assembly languages so that a programmer could define parameterized shorthands for frequently used sequences of machine instructions.

A major step towards higher-level languages was made in the latter half of the 1950's with the development of Fortran for scientific computation, Cobol for business data processing, and Lisp for symbolic computation. The philosophy behind these languages was to create higher-level notations with which programmers could more easily write numerical computations, business applications, and symbolic programs. These languages were so successful that they are still in use today.

In the following decades, many more languages were created with innovative features to help make programming easier, more natural, and more robust. Later in this chapter, we shall discuss some key features that are common to many modern programming languages.

Today, there are thousands of programming languages. They can be classified in a variety of ways. One classification is by generation. *First-generation languages* are the machine languages, *second-generation* the assembly languages, and *third-generation* the higher-level languages like Fortran, Cobol, Lisp, C, C++, C#, and Java. *Fourth-generation languages* are languages designed for specific applications like NOMAD for report generation, SQL for database queries, and Postscript for text formatting. The term *fifth-generation language* has been applied to logic- and constraint-based languages like Prolog and OPS5.

Another classification of languages uses the term *imperative* for languages in which a program specifies *how* a computation is to be done and *declarative* for languages in which a program specifies *what* computation is to be done. Languages such as C, C++, C#, and Java are imperative languages. In imperative languages there is a notion of program state and statements that change the state. Functional languages such as ML and Haskell and constraint logic languages such as Prolog are often considered to be declarative languages.

The term *von Neumann language* is applied to programming languages whose computational model is based on the von Neumann computer architecture. Many of today's languages, such as Fortran and C are von Neumann languages.

An *object-oriented language* is one that supports object-oriented programming, a programming style in which a program consists of a collection of objects that interact with one another. Simula 67 and Smalltalk are the earliest major object-oriented languages. Languages such as C++, C#, Java, and Ruby are more recent object-oriented languages.

*Scripting languages* are interpreted languages with high-level operators designed for "gluing together" computations. These computations were originally

called "scripts." Awk, JavaScript, Perl, PHP, Python, Ruby, and Tel are popular examples of scripting languages. Programs written in scripting languages are often much shorter than equivalent programs written in languages like C.

### 1.3.2 Impacts on Compilers

Since the design of programming languages and compilers are intimately related, the advances in programming languages placed new demands on compiler writers. They had to devise algorithms and representations to translate and support the new language features. Since the 1940's, computer architecture has evolved as well. Not only did the compiler writers have to track new language features, they also had to devise translation algorithms that would take maximal advantage of the new hardware capabilities.

Compilers can help promote the use of high-level languages by minimizing the execution overhead of the programs written in these languages. Compilers are also critical in making high-performance computer architectures effective on users' applications. In fact, the performance of a computer system is so dependent on compiler technology that compilers are used as a tool in evaluating architectural concepts before a computer is built.

Compiler writing is challenging. A compiler by itself is a large program. Moreover, many modern language-processing systems handle several source languages and target machines within the same framework; that is, they serve as collections of compilers, possibly consisting of millions of lines of code. Consequently, good software-engineering techniques are essential for creating and evolving modern language processors.

A compiler must translate correctly the potentially infinite set of programs that could be written in the source language. The problem of generating the optimal target code from a source program is undecidable in general; thus, compiler writers must evaluate tradeoffs about what problems to tackle and what heuristics to use to approach the problem of generating efficient code.

A study of compilers is also a study of how theory meets practice, as we shall see in Section 1.4.

The purpose of this text is to teach the methodology and fundamental ideas used in compiler design. It is not the intention of this text to teach all the algorithms and techniques that could be used for building a state-of-the-art language-processing system. However, readers of this text will acquire the basic knowledge and understanding to learn how to build a compiler relatively easily.

### 1.3.3 Exercises for Section 1.3

**Exercise 1.3.1:** Indicate which of the following terms:

- a) imperative
- b) ~~declarative~~
- c) von Neumann
- d) object-oriented
- e) ~~functional~~
- f) third-generation
- g) fourth-generation
- h) scripting

apply to which of the following languages:

- 1) C
- 2) C++
- 3) Cobol
- 4) Fortran
- 5) Java
- 6) Lisp
- 7) ML
- 8) Perl
- 9) Python
- 10) VB.

## 1.4 The Science of Building a Compiler

Compiler design is full of beautiful examples where complicated real-world problems are solved by abstracting the essence of the problem mathematically. These serve as excellent illustrations of how abstractions can be used to solve problems: take a problem, formulate a mathematical abstraction that captures the key characteristics, and solve it using mathematical techniques. The problem formulation must be grounded in a solid understanding of the characteristics of computer programs, and the solution must be validated and refined empirically.

A compiler must accept all source programs that conform to the specification of the language; the set of source programs is infinite and any program can be very large, consisting of possibly millions of lines of code. Any transformation performed by the compiler while translating a source program must preserve the meaning of the program being compiled. Compiler writers thus have influence over not just the compilers they create, but all the programs that their compilers compile. This leverage makes writing compilers particularly rewarding; however, it also makes compiler development challenging.

### 1.4.1 Modeling in Compiler Design and Implementation

The study of compilers is mainly a study of how we design the right mathematical models and choose the right algorithms, while balancing the need for generality and power against simplicity and efficiency.

Some of most fundamental models are finite-state machines and regular expressions, which we shall meet in Chapter 3. These models are useful for describing the lexical units of programs (keywords, identifiers, and such) and for describing the algorithms used by the compiler to recognize those units. Also among the most fundamental models are context-free grammars, used to describe the syntactic structure of programming languages such as the nesting of parentheses or control constructs. We shall study grammars in Chapter 4. Similarly, trees are an important model for representing the structure of programs and their translation into object code, as we shall see in Chapter 5.

### 1.4.2 The Science of Code Optimization

The term "optimization" in compiler design refers to the attempts that a compiler makes to produce code that is more efficient than the obvious code. "Optimization" is thus a misnomer, since there is no way that the code produced by a compiler can be guaranteed to be as fast or faster than any other code that performs the same task.

In modern times, the optimization of code that a compiler performs has become both more important and more complex. It is more complex because processor architectures have become more complex, yielding more opportunities to improve the way code executes. It is more important because massively parallel computers require substantial optimization, or their performance suffers by orders of magnitude. With the likely prevalence of multicore machines (computers with chips that have large numbers of processors on them), all compilers will have to face the problem of taking advantage of multiprocessor machines.

It is hard, if not impossible, to build a robust compiler out of "hacks." Thus, an extensive and useful theory has been built up around the problem of optimizing code. The use of a rigorous mathematical foundation allows us to show that an optimization is correct and that it produces the desirable effect for all possible inputs. We shall see, starting in Chapter 9, how models such as graphs, matrices, and linear programs are necessary if the compiler is to produce well optimized code.

On the other hand, pure theory alone is insufficient. Like many real-world problems, there are no perfect answers. In fact, most of the questions that we ask in compiler optimization are undecidable. One of the most important skills in compiler design is the ability to formulate the right problem to solve. We need a good understanding of the behavior of programs to start with and thorough experimentation and evaluation to validate our intuitions.

Compiler optimizations must meet the following design objectives:

- The optimization must be correct, that is, preserve the meaning of the compiled program,
- The optimization must improve the performance of many programs,
- The compilation time must be kept reasonable, and
- The engineering effort required must be manageable.

It is impossible to overemphasize the importance of correctness. It is trivial to write a compiler that generates fast code if the generated code need not be correct! Optimizing compilers are so difficult to get right that we dare say that no optimizing compiler is completely error-free! Thus, the most important objective in writing a compiler is that it is correct.

The second goal is that the compiler must be effective in improving the performance of many input programs. Normally, performance means the speed of the program execution. Especially in embedded applications, we may also wish to minimize the size of the generated code. And in the case of mobile devices, it is also desirable that the code minimizes power consumption. Typically, the same optimizations that speed up execution time also conserve power. Besides performance, usability aspects such as error reporting and debugging are also important.

Third, we need to keep the compilation time short to support a rapid development and debugging cycle. This requirement has become easier to meet as

machines get faster. Often, a program is first developed and debugged without program optimizations. Not only is the compilation time reduced, but more importantly, unoptimized programs are easier to debug, because the optimizations introduced by a compiler often obscure the relationship between the source code and the object code. Turning on optimizations in the compiler sometimes exposes new problems in the source program; thus testing must again be performed on the optimized code. The need for additional testing sometimes deters the use of optimizations in applications, especially if their performance is not critical.

Finally, a compiler is a complex system; we must keep the system simple to assure that the engineering and maintenance costs of the compiler are manageable. There is an infinite number of program optimizations that we could implement, and it takes a nontrivial amount of effort to create a correct and effective optimization. We must prioritize the optimizations, implementing only those that lead to the greatest benefits on source programs encountered in practice.

Thus, in studying compilers, we learn not only how to build a compiler, but also the general methodology of solving complex and open-ended problems. The approach used in compiler development involves both theory and experimentation. We normally start by formulating the problem based on our intuitions on what the important issues are.

## 1.5 Applications of Compiler Technology

Compiler design is not only about compilers, and many people use the technology learned by studying compilers in school, yet have never, strictly speaking, written (even part of) a compiler for a major programming language. Compiler technology has other important uses as well. Additionally, compiler design impacts several other areas of computer science. In this section, we review the most important interactions and applications of the technology.

### 1.5.1 Implementation of High-Level Programming Languages

A high-level programming language defines a programming abstraction: the programmer expresses an algorithm using the language, and the compiler must translate that program to the target language. Generally, higher-level programming languages are easier to program in, but are less efficient, that is, the target programs run more slowly. Programmers using a low-level language have more control over a computation and can, in principle, produce more efficient code. Unfortunately, lower-level programs are harder to write and — worse still — less portable, more prone to errors, and harder to maintain. Optimizing compilers include techniques to improve the performance of generated code, thus offsetting the inefficiency introduced by high-level abstractions.



**Example 1.2:** The **register** keyword in the C programming language is an early example of the interaction between compiler technology and language evolution. When the C language was created in the mid 1970s, it was considered necessary to let a programmer control which program variables reside in registers. This control became unnecessary as effective register-allocation techniques were developed, and most modern programs no longer use this language feature.

In fact, programs that use the **register** keyword may lose efficiency, because programmers often are not the best judge of very low-level matters like register allocation. The optimal choice of register allocation depends greatly on the specifics of a machine architecture. Hardwiring low-level resource-management decisions like register allocation may in fact hurt performance, especially if the program is run on machines other than the one for which it was written. •

The many shifts in the popular choice of programming languages have been in the direction of increased levels of abstraction. C was the predominant systems programming language of the 80's; many of the new projects started in the 90's chose C++; Java, introduced in 1995, gained popularity quickly in the late 90's. The new programming-language features introduced in each round spurred new research in compiler optimization. In the following, we give an overview on the main language features that have stimulated significant advances in compiler technology.

Practically all common programming languages, including C, Fortran and Cobol, support user-defined aggregate data types, such as arrays and structures, and high-level control flow, such as loops and procedure invocations. If we just take each high-level construct or data-access operation and translate it directly to machine code, the result would be very inefficient. A body of compiler optimizations, known as *data-flow optimizations*, has been developed to analyze the flow of data through the program and removes redundancies across these constructs. They are effective in generating code that resembles code written by a skilled programmer at a lower level.

Object orientation was first introduced in Simula in 1967, and has been incorporated in languages such as Smalltalk, C++, C#, and Java. The key ideas behind object orientation are

1. Data abstraction and
2. Inheritance of properties,

both of which have been found to make programs more modular and easier to maintain. Object-oriented programs are different from those written in many other languages, in that they consist of many more, but smaller, procedures (called *methods* in object-oriented terms). Thus, compiler optimizations must be able to perform well across the procedural boundaries of the source program. Procedure inlining, which is the replacement of a procedure call by the body of the procedure, is particularly useful here. Optimizations to speed up virtual method dispatches have also been developed.

Java has many features that make programming easier, many of which have been introduced previously in other languages. The Java language is type-safe; that is, an object cannot be used as an object of an unrelated type. All array accesses are checked to ensure that they lie within the bounds of the array. Java has no pointers and does not allow pointer arithmetic. It has a built-in garbage-collection facility that automatically frees the memory of variables that are no longer in use. While all these features make programming easier, they incur a run-time overhead. Compiler optimizations have been developed to reduce the overhead, for example, by eliminating unnecessary range checks and by allocating objects that are not accessible beyond a procedure on the stack instead of the heap. Effective algorithms also have been developed to minimize the overhead of garbage collection.

In addition, Java is designed to support portable and mobile code. Programs are distributed as Java bytecode, which must either be interpreted or compiled into native code dynamically, that is, at run time. Dynamic compilation has also been studied in other contexts, where information is extracted dynamically at run time and used to produce better-optimized code. In dynamic optimization, it is important to minimize the compilation time as it is part of the execution overhead. A common technique used is to only compile and optimize those parts of the program that will be frequently executed.

## 1.5.2 Optimizations for Computer Architectures

The rapid evolution of computer architectures has also led to an insatiable demand for new compiler technology. Almost all high-performance systems take advantage of the same two basic techniques: *parallelism* and *memory hierarchies*. Parallelism can be found at several levels: at the *instruction level*, where multiple operations are executed simultaneously and at the *processor level*, where different threads of the same application are run on different processors. Memory hierarchies are a response to the basic limitation that we can build very fast storage or very large storage, but not storage that is both fast and large.

### Parallelism

All modern microprocessors exploit instruction-level parallelism. However, this parallelism can be hidden from the programmer. Programs are written as if all instructions were executed in sequence; the hardware dynamically checks for dependencies in the sequential instruction stream and issues them in parallel when possible. In some cases, the machine includes a hardware scheduler that can change the instruction ordering to increase the parallelism in the program. Whether the hardware reorders the instructions or not, compilers can rearrange the instructions to make instruction-level parallelism more effective.

Instruction-level parallelism can also appear explicitly in the instruction set. VLIW (Very Long Instruction Word) machines have instructions that can issue

multiple operations in parallel. The Intel IA64 is a well-known example of such an architecture. All high-performance, general-purpose microprocessors also include instructions that can operate on a vector of data at the same time. Compiler techniques have been developed to generate code automatically for such machines from sequential programs.

Multiprocessors have also become prevalent; even personal computers often have multiple processors. Programmers can write multithreaded code for multiprocessors, or parallel code can be automatically generated by a compiler from conventional sequential programs. Such a compiler hides from the programmers the details of finding parallelism in a program, distributing the computation across the machine, and minimizing synchronization and communication among the processors. Many scientific-computing and engineering applications are computation-intensive and can benefit greatly from parallel processing. Parallelization techniques have been developed to translate automatically sequential scientific programs into multiprocessor code.

### **Memory Hierarchies**

A memory hierarchy consists of several levels of storage with different speeds and sizes, with the level closest to the processor being the fastest but smallest. The average memory-access time of a program is reduced if most of its accesses are satisfied by the faster levels of the hierarchy. Both parallelism and the existence of a memory hierarchy improve the potential performance of a machine, but they must be harnessed effectively by the compiler to deliver real performance on an application.

Memory hierarchies are found in all machines. A processor usually has a small number of registers consisting of hundreds of bytes, several levels of caches containing kilobytes to megabytes, physical memory containing megabytes to gigabytes, and finally secondary storage that contains gigabytes and beyond. Correspondingly, the speed of accesses between adjacent levels of the hierarchy can differ by two or three orders of magnitude. The performance of a system is often limited not by the speed of the processor but by the performance of the memory subsystem. While compilers traditionally focus on optimizing the processor execution, more emphasis is now placed on making the memory hierarchy more effective.

Using registers effectively is probably the single most important problem in optimizing a program. Unlike registers that have to be managed explicitly in software, caches and physical memories are hidden from the instruction set and are managed by hardware. It has been found that cache-management policies implemented by hardware are not effective in some cases, especially in scientific code that has large data structures (arrays, typically). It is possible to improve the effectiveness of the memory hierarchy by changing the layout of the data, or changing the order of instructions accessing the data. We can also change the layout of code to improve the effectiveness of instruction caches.

### 1.5.3 Design of New Computer Architectures

In the early days of computer architecture design, compilers were developed after the machines were built. That has changed. Since programming in high-level languages is the norm, the performance of a computer system is determined not by its raw speed but also by how well compilers can exploit its features. Thus, in modern computer architecture development, compilers are developed in the processor-design stage, and compiled code, running on simulators, is used to evaluate the proposed architectural features.

#### RISC

One of the best known examples of how compilers influenced the design of computer architecture was the invention of the RISC (Reduced Instruction-Set Computer) architecture. Prior to this invention, the trend was to develop progressively complex instruction sets intended to make assembly programming easier; these architectures were known as CISC (Complex Instruction-Set Computer). For example, CISC instruction sets include complex memory-addressing modes to support data-structure accesses and procedure-invocation instructions that save registers and pass parameters on the stack.

Compiler optimizations often can reduce these instructions to a small number of simpler operations by eliminating the redundancies across complex instructions. Thus, it is desirable to build simple instruction sets; compilers can use them effectively and the hardware is much easier to optimize.

Most general-purpose processor architectures, including PowerPC, SPARC, MIPS, Alpha, and PA-RISC, are based on the RISC concept. Although the x86 architecture—the most popular microprocessor—has a CISC instruction set, many of the ideas developed for RISC machines are used in the implementation of the processor itself. Moreover, the most effective way to use a high-performance x86 machine is to use just its simple instructions.

#### Specialized Architectures

Over the last three decades, many architectural concepts have been proposed. They include data flow machines, vector machines, VLIW (Very Long Instruction Word) machines, SIMD (Single Instruction, Multiple Data) arrays of processors, systolic arrays, multiprocessors with shared memory, and multiprocessors with distributed memory. The development of each of these architectural concepts was accompanied by the research and development of corresponding compiler technology.

Some of these ideas have made their way into the designs of embedded machines. Since entire systems can fit on a single chip, processors need no longer be prepackaged commodity units, but can be tailored to achieve better cost-effectiveness for a particular application. Thus, in contrast to general-purpose processors, where economies of scale have led computer architectures

to converge, application-specific processors exhibit a diversity of computer architectures. Compiler technology is needed not only to support programming for these architectures, but also to evaluate proposed architectural designs.

### 1.5.4 Program Translations

While we normally think of compiling as a translation from a high-level language to the machine level, the same technology can be applied to translate between different kinds of languages. The following are some of the important applications of program-translation techniques.

#### Binary Translation

Compiler technology can be used to translate the binary code for one machine to that of another, allowing a machine to run programs originally compiled for another instruction set. Binary translation technology has been used by various computer companies to increase the availability of software for their machines. In particular, because of the domination of the x86 personal-computer market, most software titles are available as x86 code. Binary translators have been developed to convert x86 code into both Alpha and Sparc code. Binary translation was also used by Transmeta Inc. in their implementation of the x86 instruction set. Instead of executing the complex x86 instruction set directly in hardware, the Transmeta Crusoe processor is a VLIW processor that relies on binary translation to convert x86 code into native VLIW code.

Binary translation can also be used to provide backward compatibility. When the processor in the Apple Macintosh was changed from the Motorola MC 68040 to the PowerPC in 1994, binary translation was used to allow PowerPC processors run legacy MC 68040 code.

#### Hardware Synthesis

Not only is most software written in high-level languages; even hardware designs are mostly described in high-level hardware description languages like Verilog and VHDL (Very high-speed integrated circuit Hardware Description Language). Hardware designs are typically described at the register transfer level (RTL), where variables represent registers and expressions represent combinational logic. Hardware-synthesis tools translate RTL descriptions automatically into gates, which are then mapped to transistors and eventually to a physical layout. Unlike compilers for programming languages, these tools often take hours optimizing the circuit. Techniques to translate designs at higher levels, such as the behavior or functional level, also exist.

#### Database Query Interpreters

Besides specifying software and hardware, languages are useful in many other applications. For example, query languages, especially SQL (Structured Query

Language), are used to search databases. Database queries consist of predicates containing relational and boolean operators. They can be interpreted or compiled into commands to search a database for records satisfying that predicate.

### **Compiled Simulation**

Simulation is a general technique used in many scientific and engineering disciplines to understand a phenomenon or to validate a design. Inputs to a simulator usually include the description of the design and specific input parameters for that particular simulation run. Simulations can be very expensive. We typically need to simulate many possible design alternatives on many different input sets, and each experiment may take days to complete on a high-performance machine. Instead of writing a simulator that interprets the design, it is faster to compile the design to produce machine code that simulates that particular design natively. Compiled simulation can run orders of magnitude faster than an interpreter-based approach. Compiled simulation is used in many state-of-the-art tools that simulate designs written in Verilog or VHDL.

## **1.5.5 Software Productivity Tools**

Programs are arguably the most complicated engineering artifacts ever produced; they consist of many many details, every one of which must be correct before the program will work completely. As a result, errors are rampant in programs; errors may crash a system, produce wrong results, render a system vulnerable to security attacks, or even lead to catastrophic failures in critical systems. Testing is the primary technique for locating errors in programs.

An interesting and promising complementary approach is to use data-flow analysis to locate errors statically (that is, before the program is run). Data-flow analysis can find errors along all the possible execution paths, and not just those exercised by the input data sets, as in the case of program testing. Many of the data-flow-analysis techniques, originally developed for compiler optimizations, can be used to create tools that assist programmers in their software engineering tasks.

The problem of finding all program errors is undecidable. A data-flow analysis may be designed to warn the programmers of all possible statements violating a particular category of errors. But if most of these warnings are false alarms, users will not use the tool. Thus, practical error detectors are often neither sound nor complete. That is, they may not find all the errors in the program, and not all errors reported are guaranteed to be real errors. Nonetheless, various static analyses have been developed and shown to be effective in finding errors, such as dereferencing null or freed pointers, in real programs. The fact that error detectors may be unsound makes them significantly different from compiler optimizations. Optimizers must be conservative and cannot alter the semantics of the program under any circumstances.

In the balance of this section, we shall mention several ways in which program analysis, building upon techniques originally developed to optimize code in compilers, have improved software productivity. Of special importance are techniques that detect statically when a program might have a security vulnerability.

### **Type Checking**

Type checking is an effective and well-established technique to catch inconsistencies in programs. It can be used to catch errors, for example, where an operation is applied to the wrong type of object, or if parameters passed to a procedure do not match the signature of the procedure. Program analysis can go beyond finding type errors by analyzing the flow of data through a program. For example, if a pointer is assigned null and then immediately dereferenced, the program is clearly in error.

The same technology can be used to catch a variety of security holes, in which an attacker supplies a string or other data that is used carelessly by the program. A user-supplied string can be labeled with a type "dangerous." If this string is not checked for proper format, then it remains "dangerous," and if a string of this type is able to influence the control-flow of the code at some point in the program, then there is a potential security flaw.

### **Bounds Checking**

It is easier to make mistakes when programming in a lower-level language than a higher-level one. For example, many security breaches in systems are caused by buffer overflows in programs written in C. Because C does not have array-bounds checks, it is up to the user to ensure that the arrays are not accessed out of bounds. Failing to check that the data supplied by the user can overflow a buffer, the program may be tricked into storing user data outside of the buffer. An attacker can manipulate the input data that causes the program to misbehave and compromise the security of the system. Techniques have been developed to find buffer overflows in programs, but with limited success.

Had the program been written in a safe language that includes automatic range checking, this problem would not have occurred. The same data-flow analysis that is used to eliminate redundant range checks can also be used to locate buffer overflows. The major difference, however, is that failing to eliminate a range check would only result in a small run-time cost, while failing to identify a potential buffer overflow may compromise the security of the system. Thus, while it is adequate to use simple techniques to optimize range checks, sophisticated analyses, such as tracking the values of pointers across procedures, are needed to get high-quality results in error detection tools.

### Memory-Management Tools

Garbage collection is another excellent example of the tradeoff between efficiency and a combination of ease of programming and software reliability. Automatic memory management obliterates all memory-management errors (e.g., "memory leaks"), which are a major source of problems in C and C++ programs. Various tools have been developed to help programmers find memory management errors. For example, Purify is a widely used tool that dynamically catches memory management errors as they occur. Tools that help identify some of these problems statically have also been developed.

## 1.6 Programming Language Basics

In this section, we shall cover the most important terminology and distinctions that appear in the study of programming languages. It is not our purpose to cover all concepts or all the popular programming languages. We assume that the reader is familiar with at least one of C, C++, C#, or Java, and may have encountered other languages as well.

### 1.6.1 The Static/Dynamic Distinction

Among the most important issues that we face when designing a compiler for a language is what decisions can the compiler make about a program. If a language uses a policy that allows the compiler to decide an issue, then we say that the language uses a *static* policy or that the issue can be decided at *compile time*. On the other hand, a policy that only allows a decision to be made when we execute the program is said to be a *dynamic policy* or to require a decision at *run time*.

One issue on which we shall concentrate is the scope of declarations. The *scope* of a declaration of  $x$  is the region of the program in which uses of  $x$  refer to this declaration. A language uses *static scope* or *lexical scope* if it is possible to determine the scope of a declaration by looking only at the program. Otherwise, the language uses *dynamic scope*. With dynamic scope, as the program runs, the same use of  $x$  could refer to any of several different declarations of  $x$ .

Most languages, such as C and Java, use static scope. We shall discuss static scoping in Section 1.6.3.

**Example 1.3 :** As another example of the static/dynamic distinction, consider the use of the term "static" as it applies to data in a Java class declaration. In Java, a variable is a name for a location in memory used to hold a data value. Here, "static" refers not to the scope of the variable, but rather to the ability of the compiler to determine the location in memory where the declared variable can be found. A declaration like

```
public static int x;
```



makes  $x$  a *class variable* and says that there is only one copy of  $x$ , no matter how many objects of this class are created. Moreover, the compiler can determine a location in memory where this integer  $x$  will be held. In contrast, had "static" been omitted from this declaration, then each object of the class would have its own location where  $x$  would be held, and the compiler could not determine all these places in advance of running the program. •

## 1.6.2 Environments and States

Another important distinction we must make when discussing programming languages is whether changes occurring as the program runs affect the values of data elements or affect the interpretation of names for that data. For example, the execution of an assignment such as  $\mathbf{x = y + 1}$  changes the value denoted by the name  $x$ . More specifically, the assignment changes the value in whatever location is denoted by  $x$ .

It may be less clear that the location denoted by  $x$  can change at run time. For instance, as we discussed in Example 1.3, if  $x$  is not a static (or "class") variable, then every object of the class has its own location for an instance of variable  $x$ . In that case, the assignment to  $x$  can change any of those "instance" variables, depending on the object to which a method containing that assignment is applied.

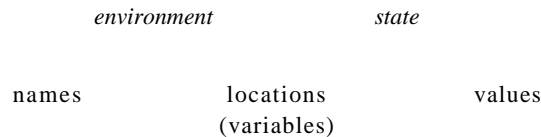

Figure 1.8: Two-stage mapping from names to values

The association of names with locations in memory (the *store*) and then with values can be described by two mappings that change as the program runs (see Fig. 1.8):

1. The *environment* is a mapping from names to locations in the store. Since variables refer to locations ("l-values" in the terminology of C), we could alternatively define an environment as a mapping from names to variables.
2. The *state* is a mapping from locations in store to their values. That is, the state maps l-values to their corresponding r-values, in the terminology of C.

Environments change according to the scope rules of a language.

**Example 1.4:** Consider the C program fragment in Fig. 1.9. Integer  $i$  is declared a global variable, and also declared as a variable local to function  $f$ . When  $f$  is executing, the environment adjusts so that name  $i$  refers to the

```

int i;                /* global i    */

void f(---) {
    int i;            /* local i    */

    i = 3;            /* use of local i */

}

x = i + 1;           /* use of global i */

```

Figure 1.9: Two declarations of the name *i*

location reserved for the *i* that is local to *f*, and any use of *i*, such as the assignment `i = 3` shown explicitly, refers to that location. Typically, the local *i* is given a place on the run-time stack.

Whenever a function *g* other than *f* is executing, uses of *i* cannot refer to the *i* that is local to *f*. Uses of name *i* in *g* must be within the scope of some other declaration of *i*. An example is the explicitly shown statement `x = i+1`, which is inside some procedure whose definition is not shown. The *i* in `i + 1` presumably refers to the global *i*. As in most languages, declarations in C must precede their use, so a function that comes before the global *i* cannot refer to it. •

The environment and state mappings in Fig. 1.8 are dynamic, but there are a few exceptions:

1. *Static versus dynamic binding* of names to locations. Most binding of names to locations is dynamic, and we discuss several approaches to this binding throughout the section. Some declarations, such as the global *i* in Fig. 1.9, can be given a location in the store once and for all, as the compiler generates object code.<sup>2</sup>
2. *Static versus dynamic binding* of locations to values. The binding of locations to values (the second stage in Fig. 1.8), is generally dynamic as well, since we cannot tell the value in a location until we run the program. Declared constants are an exception. For instance, the C definition

```
#define ARRAYSIZE 1000
```

<sup>2</sup>Technically, the C compiler will assign a location in virtual memory for the global *i*, leaving it to the loader and the operating system to determine where in the physical memory of the machine *i* will be located. However, we shall not worry about "relocation" issues such as these, which have no impact on compiling. Instead, we treat the address space that the compiler uses for its output code as if it gave physical memory locations.

## Names, Identifiers, and Variables

Although the terms "name" and "variable," often refer to the same thing, we use them carefully to distinguish between compile-time names and the run-time locations denoted by names.

An *identifier* is a string of characters, typically letters or digits, that refers to (identifies) an entity, such as a data object, a procedure, a class, or a type. All identifiers are names, but not all names are identifiers. Names can also be expressions. For example, the name  $x.y$  might denote the field  $y$  of a structure denoted by  $x$ . Here,  $x$  and  $y$  are identifiers, while  $x.y$  is a name, but not an identifier. Composite names like  $x.y$  are called *qualified* names.

A *variable* refers to a particular location of the store. It is common for the same identifier to be declared more than once; each such declaration introduces a new variable. Even if each identifier is declared just once, an identifier local to a recursive procedure will refer to different locations of the store at different times.

binds the name **ARRAYS** IZE to the value 1000 statically. We can determine this binding by looking at the statement, and we know that it is impossible for this binding to change when the program executes.

### 1.6.3 Static Scope and Block Structure

Most languages, including C and its family, use static scope. The scope rules for C are based on program structure; the scope of a declaration is determined implicitly by where the declaration appears in the program. Later languages, such as C++, Java, and C#, also provide explicit control over scopes through the use of keywords like **public**, **private**, and **protected**.

In this section we consider static-scope rules for a language with blocks, where a *block* is a grouping of declarations and statements. C uses braces { and } to delimit a block; the alternative use of **begin** and **end** for the same purpose dates back to Algol.

**Example 1.5** : To a first approximation, the C static-scope policy is as follows:

1. A C program consists of a sequence of top-level declarations of variables and functions.
2. Functions may have variable declarations within them, where variables include local variables and parameters. The scope of each such declaration is restricted to the function in which it appears.

## Procedures, Functions, and Methods

To avoid saying "procedures, functions, or methods," each time we want to talk about a subprogram that may be called, we shall usually refer to all of them as "procedures." The exception is that when talking explicitly of programs in languages like C that have only functions, we shall refer to them as "functions." Or, if we are discussing a language like Java that has only methods, we shall use that term instead.

A function generally returns a value of some type (the "return type"), while a procedure does not return any value. C and similar languages, which have only functions, treat procedures as functions that have a special return type "void," to signify no return value. Object-oriented languages like Java and C++ use the term "methods." These can behave like either functions or procedures, but are associated with a particular class.

3. The scope of a top-level declaration of a name  $x$  consists of the entire program that follows, with the exception of those statements that lie within a function that also has a declaration of  $x$ .

The additional detail regarding the C static-scope policy deals with variable declarations within statements. We examine such declarations next and in Example 1.6. •

In C, the syntax of blocks is given by

1. One type of statement is a block. Blocks can appear anywhere that other types of statements, such as assignment statements, can appear.
2. A block is a sequence of declarations followed by a sequence of statements, all surrounded by braces.

Note that this syntax allows blocks to be nested inside each other. This nesting property is referred to as *block structure*. The C family of languages has block structure, except that a function may not be defined inside another function.

We say that a declaration  $D$  "belongs" to a block  $B$  if  $B$  is the most closely nested block containing  $D$ ; that is,  $D$  is located within  $B$ , but not within any block that is nested within  $B$ .

The static-scope rule for variable declarations in a block-structured languages is as follows. If declaration  $D$  of name  $x$  belongs to block  $B$ , then the scope of  $D$  is all of  $B$ , except for any blocks  $B'$  nested to any depth within  $B$ , in which  $x$  is redeclared. Here,  $x$  is redeclared in  $B'$  if some other declaration  $D'$  of the same name  $x$  belongs to  $B'$ .

An equivalent way to express this rule is to focus on a use of a name  $x$ . Let  $B_i, i \geq 2, \dots, B_k$  be all the blocks that surround this use of  $x$ , with  $B_k$  the smallest, nested within  $B_{k-1}$ , which is nested within  $B_{k-2}$ , and so on. Search for the largest  $i$  such that there is a declaration of  $x$  belonging to  $B^i$ . This use of  $x$  refers to the declaration in  $B^i$ . Alternatively, this use of  $x$  is within the scope of the declaration in  $B^i$ .

```

main() {
    int a = 1;
    int b = 1;
    {
        f int b = 2;
        {
            int a = 3;
            cout << a << b;
        }
        {
            int b = 4;
            cout << a << b;
        }
        cout << a << b;
    }
    cout << a << b;
}

```

Figure 1.10: Blocks in a C++ program

**Example 1.6:** The C++ program in Fig. 1.10 has four blocks, with several definitions of variables  $a$  and  $b$ . As a memory aid, each declaration initializes its variable to the number of the block to which it belongs.

For instance, consider the declaration `int a = 1` in block  $B_1$ . Its scope is all of  $B_1$ , except for those blocks nested (perhaps deeply) within  $B_1$  that have their own declaration of  $a$ .  $B_2$ , nested immediately within  $B_1$ , does not have a declaration of  $a$ , but  $B_3$  does.  $B_4$  does not have a declaration of  $a$ , so block  $B_3$  is the only place in the entire program that is outside the scope of the declaration of the name  $a$  that belongs to  $B_1$ . That is, this scope includes  $B_4$  and all of  $B_2$ , except for the part of  $B_2$  that is within  $B_3$ . The scopes of all five declarations are summarized in Fig. 1.11.

From another point of view, let us consider the output statement in block  $B_4$  and bind the variables  $a$  and  $b$  used there to the proper declarations. The list of surrounding blocks, in order of increasing size, is  $B_1, B_2, B_1$ . Note that  $B_3$  does not surround the point in question.  $B_4$  has a declaration of  $b$ , so it is to this declaration that this use of  $b$  refers, and the value of 6 printed is 4. However,  $B_4$  does not have a declaration of  $a$ , so we next look at  $B_2$ . That block does not have a declaration of  $a$  either, so we proceed to  $B_1$ . Fortunately,

DECLARATION	SCOPE
int a = 1	$B_1 - B_2$
int b = 1	$B_1 - B_2$
int b = 2	$B_2 - B_3$
int a = 3	$B_3$
int b = 4	$B_3$

Figure 1.11: Scopes of declarations in Example 1.6

there is a declaration `int a = 1` belonging to that block, so the value of `a` printed is 1. Had there been no such declaration, the program would have been erroneous. •

### 1.6.4 Explicit Access Control

Classes and structures introduce a new scope for their members. If  $p$  is an object of a class with a field (member)  $x$ , then the use of  $x$  in  $p.x$  refers to field  $x$  in the class definition. In analogy with block structure, the scope of a member declaration  $x$  in a class  $C$  extends to any subclass  $C$ , except if  $C$  has a local declaration of the same name  $x$ .

Through the use of keywords like **public**, **private**, and **protected**, object-oriented languages such as C++ or Java provide explicit control over access to member names in a superclass. These keywords support *encapsulation* by restricting access. Thus, private names are purposely given a scope that includes only the method declarations and definitions associated with that class and any "friend" classes (the C++ term). Protected names are accessible to subclasses. Public names are accessible from outside the class.

In C++, a class definition may be separated from the definitions of some or all of its methods. Therefore, a name  $x$  associated with the class  $C$  may have a region of the code that is outside its scope, followed by another region (a method definition) that is within its scope. In fact, regions inside and outside the scope may alternate, until all the methods have been defined.

### 1.6.5 Dynamic Scope

Technically, any scoping policy is dynamic if it is based on factor(s) that can be known only when the program executes. The term *dynamic scope*, however, usually refers to the following policy: a use of a name  $x$  refers to the declaration of  $x$  in the most recently called procedure with such a declaration. Dynamic scoping of this type appears only in special situations. We shall consider two examples of dynamic policies: macro expansion in the C preprocessor and method resolution in object-oriented programming.

## Declarations and Definitions

The apparently similar terms "declaration" and "definition" for programming-language concepts are actually quite different. Declarations tell us about the types of things, while definitions tell us about their values. Thus, `int i` is a declaration of `i`, while `i = 1` is a definition of `i`.

The difference is more significant when we deal with methods or other procedures. In C++, a method is declared in a class definition, by giving the types of the arguments and result of the method (often called the *signature* for the method). The method is then defined, i.e., the code for executing the method is given, in another place. Similarly, it is common to define a C function in one file and declare it in other files where the function is used.

**Example 1.7:** In the C program of Fig. 1.12, identifier `a` is a macro that stands for expression `(a? + 1)`. But what is `x`? We cannot resolve `x` statically, that is, in terms of the program text.

```
#define a (x+1)
int x = 2;
void b() { int x = 1; printf("/.d\n", a); }
void c() { printf("/.d\n", a); }
void main() { b(); c(); }
```

Figure 1.12: A macro whose names must be scoped dynamically

In fact, in order to interpret `x`, we must use the usual dynamic-scope rule. We examine all the function calls that are currently active, and we take the most recently called function that has a declaration of `x`. It is to this declaration that the use of `x` refers.

In the example of Fig. 1.12, the function `main` first calls function `b`. As `b` executes, it prints the value of the macro `a`. Since `(x + 1)` must be substituted for `a`, we resolve this use of `x` to the declaration `int x=1` in function `b`. The reason is that `b` has a declaration of `x`, so the `(x + 1)` in the `printf` in `b` refers to this `x`. Thus, the value printed is 1.

After `b` finishes, and `c` is called, we again need to print the value of macro `a`. However, the only `x` accessible to `c` is the global `x`. The `printf` statement in `c` thus refers to this declaration of `x`, and value 2 is printed. •

Dynamic scope resolution is also essential for polymorphic procedures, those that have two or more definitions for the same name, depending only on the

## Analogy Between Static and Dynamic Scoping

While there could be any number of static or dynamic policies for scoping, there is an interesting relationship between the normal (block-structured) static scoping rule and the normal dynamic policy. In a sense, the dynamic rule is to time as the static rule is to space. While the static rule asks us to find the declaration whose unit (block) most closely surrounds the physical location of the use, the dynamic rule asks us to find the declaration whose unit (procedure invocation) most closely surrounds the time of the use.

types of the arguments. In some languages, such as ML (see Section 7.3.3), it is possible to determine statically types for all uses of names, in which case the compiler can replace each use of a procedure name  $p$  by a reference to the code for the proper procedure. However, in other languages, such as Java and C++, there are times when the compiler cannot make that determination.

**Example 1.8:** A distinguishing feature of object-oriented programming is the ability of each object to invoke the appropriate method in response to a message. In other words, the procedure called when  $x.mQ$  is executed depends on the class of the object denoted by  $x$  at that time. A typical example is as follows:

1. There is a class  $C$  with a method named  $m()$ .
2.  $D$  is a subclass of  $C$ , and  $D$  has its own method named  $ra()$ .
3. There is a use of  $m$  of the form  $x.mQ$ , where  $x$  is an object of class  $C$ .

Normally, it is impossible to tell at compile time whether  $x$  will be of class  $C$  or of the subclass  $D$ . If the method application occurs several times, it is highly likely that some will be on objects denoted by  $x$  that are in class  $C$  but not  $D$ , while others will be in class  $D$ . It is not until run-time that it can be decided which definition of  $m$  is the right one. Thus, the code generated by the compiler must determine the class of the object  $x$ , and call one or the other method named  $m$ . •

### 1.6.6 Parameter Passing Mechanisms

All programming languages have a notion of a procedure, but they can differ in how these procedures get their arguments. In this section, we shall consider how the *actual parameters* (the parameters used in the call of a procedure) are associated with the *formal parameters* (those used in the procedure definition). Which mechanism is used determines how the calling-sequence code treats parameters. The great majority of languages use either "call-by-value," or "call-by-reference," or both. We shall explain these terms, and another method known as "call-by-name," that is primarily of historical interest.



### Call-by-Value

In *call-by-value*, the actual parameter is evaluated (if it is an expression) or copied (if it is a variable). The value is placed in the location belonging to the corresponding formal parameter of the called procedure. This method is used in C and Java, and is a common option in C++, as well as in most other languages. Call-by-value has the effect that all computation involving the formal parameters done by the called procedure is local to that procedure, and the actual parameters themselves cannot be changed.

Note, however, that in C we can pass a pointer to a variable to allow that variable to be changed by the callee. Likewise, array names passed as parameters in C, C++, or Java give the called procedure what is in effect a pointer or reference to the array itself. Thus, if  $a$  is the name of an array of the calling procedure, and it is passed by value to corresponding formal parameter  $x$ , then an assignment such as  $x[i] = 2$  really changes the array element  $a[2]$ . The reason is that, although  $x$  gets a copy of the value of  $a$ , that value is really a pointer to the beginning of the area of the store where the array named  $a$  is located.

Similarly, in Java, many variables are really references, or pointers, to the things they stand for. This observation applies to arrays, strings, and objects of all classes. Even though Java uses call-by-value exclusively, whenever we pass the name of an object to a called procedure, the value received by that procedure is in effect a pointer to the object. Thus, the called procedure is able to affect the value of the object itself.

### Call-by-Reference

In *call-by-reference*, the address of the actual parameter is passed to the callee as the value of the corresponding formal parameter. Uses of the formal parameter in the code of the callee are implemented by following this pointer to the location indicated by the caller. Changes to the formal parameter thus appear as changes to the actual parameter.

If the actual parameter is an expression, however, then the expression is evaluated before the call, and its value stored in a location of its own. Changes to the formal parameter change this location, but can have no effect on the data of the caller.

Call-by-reference is used for "ref" parameters in C++ and is an option in many other languages. It is almost essential when the formal parameter is a large object, array, or structure. The reason is that strict call-by-value requires that the caller copy the entire actual parameter into the space belonging to the corresponding formal parameter. This copying gets expensive when the parameter is large. As we noted when discussing call-by-value, languages such as Java solve the problem of passing arrays, strings, or other objects by copying only a reference to those objects. The effect is that Java behaves as if it used call-by-reference for anything other than a basic type such as an integer or real.

### Call-by-Name

A third mechanism — call-by-name — was used in the early programming language Algol 60. It requires that the callee execute as if the actual parameter were substituted literally for the formal parameter in the code of the callee, as if the formal parameter were a macro standing for the actual parameter (with renaming of local names in the called procedure, to keep them distinct). When the actual parameter is an expression rather than a variable, some unintuitive behaviors occur, which is one reason this mechanism is not favored today.

### 1.6.7 Aliasing

There is an interesting consequence of call-by-reference parameter passing or its simulation, as in Java, where references to objects are passed by value. It is possible that two formal parameters can refer to the same location; such variables are said to be *aliases* of one another. As a result, any two variables, which may appear to take their values from two distinct formal parameters, can become aliases of each other, as well.

**Example 1.9:** Suppose  $a$  is an array belonging to a procedure  $p$ , and  $p$  calls another procedure  $q(x,y)$  with a call  $q(a,a)$ . Suppose also that parameters are passed by value, but that array names are really references to the location where the array is stored, as in C or similar languages. Now,  $x$  and  $y$  have become aliases of each other. The important point is that if within  $q$  there is an assignment  $x[10] = 2$ , then the value of  $y[10]$  also becomes 2. •

It turns out that understanding aliasing and the mechanisms that create it is essential if a compiler is to optimize a program. As we shall see starting in Chapter 9, there are many situations where we can only optimize code if we can be sure certain variables are not aliased. For instance, we might determine that  $x = 2$  is the only place that variable  $x$  is ever assigned. If so, then we can replace a use of  $x$  by a use of 2; for example, replace  $a = x+3$  by the simpler  $a = 5$ . But suppose there were another variable  $y$  that was aliased to  $x$ . Then an assignment  $y = 4$  might have the unexpected effect of changing  $x$ . It might also mean that replacing  $a = x+3$  by  $a = 5$  was a mistake; the proper value of  $a$  could be 7 there.

### 1.6.8 Exercises for Section 1.6

**Exercise 1.6.1:** For the block-structured C code of Fig. 1.13(a), indicate the values assigned to  $w$ ,  $x$ ,  $y$ , and  $z$ .

**Exercise 1.6.2:** Repeat Exercise 1.6.1 for the code of Fig. 1.13(b).

**Exercise 1.6.3:** For the block-structured code of Fig. 1.14, assuming the usual static scoping of declarations, give the scope for each of the twelve declarations.

```

int w, x, y, z;
int i = 4; int j = 5;
< int j = 7;
   i = 6;
   w = i + j;
}
x = i + j;
{ int i = 8;
  y = i + j;
}
z = i + j;

```

(a) Code for Exercise 1.6.1

```

int w, x, y, z;
int i = 3; int j = 4;
{ int i = 5;
  w = i + j;
}
x = i + j;
{ int j = 6;
  i = 7;
  y = i + j;
}
z = i + j;

```

(b) Code for Exercise 1.6.2

Figure 1.13: Block-structured code

```

int w, x, y, z; /* Block B1 */
{ int x, z; /* Block B2 */
  { int w, x; /* Block B3 */ }
}
{ int w, x; /* Block B4 */
  { int y, z; /* Block B5 */ }
}

```

Figure 1.14: Block structured code for Exercise 1.6.3

**Exercise 1.6.4:** What is printed by the following C code?

```

#define a (x+1)
int x = 2;
void b() { x = a; printf("%d\n", x); }
void c() { int x = 1; printf("%d\n", a); }
void main() { b(); c(); }

```

## 1.7 Summary of Chapter 1

- *Language Processors.* An integrated software development environment includes many different kinds of language processors such as compilers, interpreters, assemblers, linkers, loaders, debuggers, profilers.
- *Compiler Phases.* A compiler operates as a sequence of phases, each of which transforms the source program from one intermediate representation to another.

- 4> *Machine and Assembly Languages.* Machine languages were the first-generation programming languages, followed by assembly languages. Programming in these languages was time consuming and error prone.
- 4 *Modeling in Compiler Design.* Compiler design is one of the places where theory has had the most impact on practice. Models that have been found useful include automata, grammars, regular expressions, trees, and many others.
- 4 *Code Optimization.* Although code cannot truly be "optimized," the science of improving the efficiency of code is both complex and very important. It is a major portion of the study of compilation.
- 4 *Higher-Level Languages.* As time goes on, programming languages take on progressively more of the tasks that formerly were left to the programmer, such as memory management, type-consistency checking, or parallel execution of code.
- 4 *Compilers and Computer Architecture.* Compiler technology influences computer architecture, as well as being influenced by the advances in architecture. Many modern innovations in architecture depend on compilers being able to extract from source programs the opportunities to use the hardware capabilities effectively.
- 4 *Software Productivity and Software Security.* The same technology that allows compilers to optimize code can be used for a variety of program-analysis tasks, ranging from detecting common program bugs to discovering that a program is vulnerable to one of the many kinds of intrusions that "hackers" have discovered.
- 4 *Scope Rules.* The *scope* of a declaration of  $x$  is the context in which uses of  $x$  refer to this declaration. A language uses *static scope* or *lexical scope* if it is possible to determine the scope of a declaration by looking only at the program. Otherwise, the language uses *dynamic scope*.
- 4 *Environments.* The association of names with locations in memory and then with values can be described in terms of *environments*, which map names to locations in store, and *states*, which map locations to their values.
- 4- *Block Structure.* Languages that allow blocks to be nested are said to have *block structure*. A name  $a$ : in a nested block  $B$  is in the scope of a declaration  $D$  of  $x$  in an enclosing block if there is no other declaration of  $x$  in an intervening block.
- 4 *Parameter Passing.* Parameters are passed from a calling procedure to the callee either by value or by reference. When large objects are passed by value, the values passed are really references to the objects themselves, resulting in an effective call-by-reference.

- *Aliasing*. When parameters are (effectively) passed by reference, two formal parameters can refer to the same object. This possibility allows a change in one variable to change another.

## 1.8 References for Chapter 1

For the development of programming languages that were created and in use by 1967, including Fortran, Algol, Lisp, and Simula, see [7]. For languages that were created by 1982, including C, C++, Pascal, and Smalltalk, see [1].

The GNU Compiler Collection, `gcc`, is a popular source of open-source compilers for C, C++, Fortran, Java, and other languages [2]. Phoenix is a compiler-construction toolkit that provides an integrated framework for building the program analysis, code generation, and code optimization phases of compilers discussed in this book [3].

For more information about programming language concepts, we recommend [5,6]. For more on computer architecture and how it impacts compiling, we suggest [4].

1. Bergin, T. J. and R. G. Gibson, *History of Programming Languages*, ACM Press, New York, 1996.
2. <http://gcc.gnu.org/>.
3. <http://research.microsoft.com/phoenix/default.aspx> .
4. Hennessy, J. L. and D. A. Patterson, *Computer Organization and Design: The Hardware/Software Interface*, Morgan-Kaufmann, San Francisco, CA, 2004.
5. Scott, M. L., *Programming Language Pragmatics, second edition*, Morgan-Kaufmann, San Francisco, CA, 2006.
6. Sethi, R., *Programming Languages: Concepts and Constructs*, Addison-Wesley, 1996.
7. Wexelblat, R. L., *History of Programming Languages*, Academic Press, New York, 1981.

## Chapter 2

# A Simple Syntax-Directed Translator

This chapter is an introduction to the compiling techniques in Chapters 3 through 6 of this book. It illustrates the techniques by developing a working Java program that translates representative programming language statements into three-address code, an intermediate representation. In this chapter, the emphasis is on the front end of a compiler, in particular on lexical analysis, parsing, and intermediate code generation. Chapters 7 and 8 show how to generate machine instructions from three-address code.

We start small by creating a syntax-directed translator that maps infix arithmetic expressions into postfix expressions. We then extend this translator to map code fragments as shown in Fig. 2.1 into three-address code of the form in Fig. 2.2.

The working Java translator appears in Appendix A. The use of Java is convenient, but not essential. In fact, the ideas in this chapter predate the creation of both Java and C.

```
{
    int i; int j; float[100] a; float v; float x;
    while ( true ) {
        do i = i+1; while ( a[i] < v );
        do j = j-1; while ( a[j] > v );
        if ( i >= j ) break;
        x = a[i]; a[i] = a[j]; a[j] = x;
    }
}
```

Figure 2.1: A code fragment to be translated

```
1  i = i + 1
2  t1 = a [ i ]
3:  if t1 < v goto 1
4:  J = J - 1
5:  t2 = a [ j ]
6:  if t2 > v goto 4
7:  ifFalse i >= j goto 9
8:  goto 14
9:  x = a [ i ]
10: t3 = a [ j ]
11: a [ i ] = t3
12: a [ j ] = x
13: goto 1
14:
```

Figure 2.2: Simplified intermediate code for the program fragment in Fig. 2.1

## 2.1 Introduction

The analysis phase of a compiler breaks up a source program into constituent pieces and produces an internal representation for it, called intermediate code. The synthesis phase translates the intermediate code into the target program.

Analysis is organized around the "syntax" of the language to be compiled. The *syntax* of a programming language describes the proper form of its programs, while the *semantics* of the language defines what its programs mean; that is, what each program does when it executes. For specifying syntax, we present a widely used notation, called context-free grammars or BNF (for Backus-Naur Form) in Section 2.2. With the notations currently available, the semantics of a language is much more difficult to describe than the syntax. For specifying semantics, we shall therefore use informal descriptions and suggestive examples.

Besides specifying the syntax of a language, a context-free grammar can be used to help guide the translation of programs. In Section 2.3, we introduce a grammar-oriented compiling technique known as *syntax-directed translation*. Parsing or syntax analysis is introduced in Section 2.4.

The rest of this chapter is a quick tour through the model of a compiler front end in Fig. 2.3. We begin with the parser. For simplicity, we consider the syntax-directed translation of infix expressions to postfix form, a notation in which operators appear after their operands. For example, the postfix form of the expression  $9 - 5 + 2$  is  $95 - 2+$ . Translation into postfix form is rich enough to illustrate syntax analysis, yet simple enough that the translator is shown in full in Section 2.5. The simple translator handles expressions like  $9 - 5 + 2$ , consisting of digits separated by plus and minus signs. One reason for starting with such simple expressions is that the syntax analyzer can work directly with the individual characters for operators and operands.

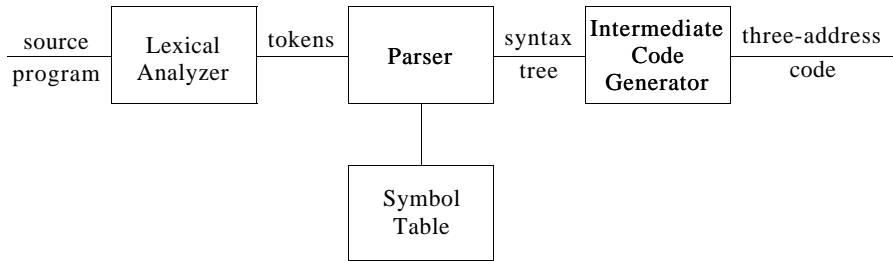
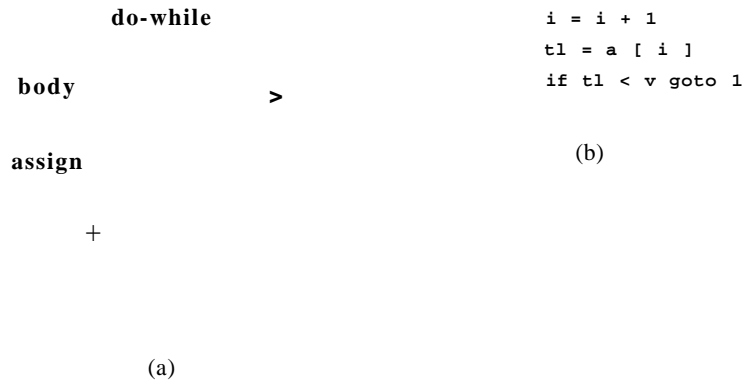

Figure 2.3: A model of a compiler front end

A lexical analyzer allows a translator to handle multicharacter constructs like identifiers, which are written as sequences of characters, but are treated as units called *tokens* during syntax analysis; for example, in the expression `count+1`, the identifier `count` is treated as a unit. The lexical analyzer in Section 2.6 allows numbers, identifiers, and "white space" (blanks, tabs, and newlines) to appear within expressions.

Next, we consider intermediate-code generation. Two forms of intermediate code are illustrated in Fig. 2.4. One form, called *abstract syntax trees* or simply *syntax trees*, represents the hierarchical syntactic structure of the source program. In the model in Fig. 2.3, the parser produces a syntax tree, that is further translated into three-address code. Some compilers combine parsing and intermediate-code generation into one component.

Figure 2.4: Intermediate code for `"do i = i + 1; while ( a [ i ] < v );"`

The root of the abstract syntax tree in Fig. 2.4(a) represents an entire do-while loop. The left child of the root represents the body of the loop, which consists of only the assignment `i = i + 1`; the right child of the root represents the condition `a [ i ] < v`. An implementation of syntax trees appears in Section 2.8(a).

The other common intermediate representation, shown in Fig. 2.4(b), is a



sequence of "three-address" instructions; a more complete example appears in Fig. 2.2. This form of intermediate code takes its name from instructions of the form  $x = y \text{ op } z$ , where **op** is a binary operator,  $y$  and  $z$  are addresses for the operands, and  $x$  is the address for the result of the operation. A three-address instruction carries out at most one operation, typically a computation, a comparison, or a branch.

In Appendix A, we put the techniques in this chapter together to build a compiler front end in Java. The front end translates statements into assembly-level instructions.

## 2.2 Syntax Definition

In this section, we introduce a notation — the "context-free grammar," or "grammar" for short — that is used to specify the syntax of a language. Grammars will be used throughout this book to organize compiler front ends.

A grammar naturally describes the hierarchical structure of most programming language constructs. For example, an if-else statement in Java can have the form

$$\mathbf{if} ( \text{expression} ) \text{ statement } \mathbf{else} \text{ statement}$$

That is, an if-else statement is the concatenation of the keyword **if**, an opening parenthesis, an expression, a closing parenthesis, a statement, the keyword **else**, and another statement. Using the variable *expr* to denote an expression and the variable *stmt* to denote a statement, this structuring rule can be expressed as

$$\text{stmt} \rightarrow \mathbf{if} ( \text{expr} ) \text{ stmt } \mathbf{else} \text{ stmt}$$

in which the arrow may be read as "can have the form." Such a rule is called a *production*. In a production, lexical elements like the keyword **if** and the parentheses are called *terminals*. Variables like *expr* and *stmt* represent sequences of terminals and are called *nonterminals*.

### 2.2.1 Definition of Grammars

A *context-free grammar* has four components:

1. A set of *terminal* symbols, sometimes referred to as "tokens." The terminals are the elementary symbols of the language defined by the grammar.
2. A set of *nonterminals*, sometimes called "syntactic variables." Each nonterminal represents a set of strings of terminals, in a manner we shall describe.
3. A set of *productions*, where each production consists of a nonterminal, called the *head* or *left side* of the production, an arrow, and a sequence of

## Tokens Versus Terminals

In a compiler, the lexical analyzer reads the characters of the source program, groups them into lexically meaningful units called lexemes, and produces as output tokens representing these lexemes. A token consists of two components, a token name and an attribute value. The token names are abstract symbols that are used by the parser for syntax analysis. Often, we shall call these token names *terminals*, since they appear as terminal symbols in the grammar for a programming language. The attribute value, if present, is a pointer to the symbol table that contains additional information about the token. This additional information is not part of the grammar, so in our discussion of syntax analysis, often we refer to tokens and terminals synonymously.

terminals and/or nonterminals, called the *body* or *right side* of the production. The intuitive intent of a production is to specify one of the written forms of a construct; if the head nonterminal represents a construct, then the body represents a written form of the construct.

4. A designation of one of the nonterminals as the *start* symbol.

We specify grammars by listing their productions, with the productions for the start symbol listed first. We assume that digits, signs such as < and <=, and boldface strings such as **while** are terminals. An italicized name is a nonterminal, and any nonitalicized name or symbol may be assumed to be a terminal.<sup>1</sup> For notational convenience, productions with the same nonterminal as the head can have their bodies grouped, with the alternative bodies separated by the symbol |, which we read as "or."

**Example 2.1:** Several examples in this chapter use expressions consisting of digits and plus and minus signs; e.g., strings such as 9-5+2, 3-1, or 7. Since a plus or minus sign must appear between two digits, we refer to such expressions as "lists of digits separated by plus or minus signs." The following grammar describes the syntax of these expressions. The productions are:

$$list \rightarrow list + digit \quad (2.1)$$

$$list \rightarrow list - digit \quad (2.2)$$

$$list \rightarrow \bullet digit \quad (2.3)$$

$$digit \rightarrow 0 | 1 | 2 | 3 | 4 | 5 | 6 | 7 | 8 | 9 \quad (2.4)$$

<sup>1</sup>Individual italic letters will be used for additional purposes, especially when grammars are studied in detail in Chapter 4. For example, we shall use **X**, **Y**, and **Z** to talk about a symbol that is either a terminal or a nonterminal. However, any italicized name containing two or more characters will continue to represent a nonterminal.

The bodies of the three productions with nonterminal *list* as head equivalently can be grouped:

$$\textit{list} \quad -+ \quad \textit{list} + \textit{digit} \quad | \quad \textit{list} - \textit{digit} \quad | \quad \textit{digit}$$

According to our conventions, the terminals of the grammar are the symbols

+ - 0 1 2 3 4 5 6 7 8 9

The nonterminals are the italicized names *list* and *digit*, with *list* being the start symbol because its productions are given first. •

We say a production is *for* a nonterminal if the nonterminal is the head of the production. A string of terminals is a sequence of zero or more terminals. The string of zero terminals, written as *e*, is called the *empty* string.<sup>2</sup>

### 2.2.2 Derivations

A grammar derives strings by beginning with the start symbol and repeatedly replacing a nonterminal by the body of a production for that nonterminal. The terminal strings that can be derived from the start symbol form the *language* defined by the grammar.

**Example 2.2:** The language defined by the grammar of Example 2.1 consists of lists of digits separated by plus and minus signs. The ten productions for the nonterminal *digit* allow it to stand for any of the terminals **0,1,...,9**. From production (2.3), a single digit by itself is a list. Productions (2.1) and (2.2) express the rule that any list followed by a plus or minus sign and then another digit makes up a new list.

Productions (2.1) to (2.4) are all we need to define the desired language. For example, we can deduce that **9-5+2** is a *list* as follows.

- a) **9** is a *list* by production (2.3), since **9** is a *digit*.
- b) **9-5** is a *list* by production (2.2), since **9** is a *list* and **5** is a *digit*.
- c) **9-5+2** is a *list* by production (2.1), since **9-5** is a *list* and **2** is a *digit*.

•

**Example 2.3:** A somewhat different sort of list is the list of parameters in a function call. In Java, the parameters are enclosed within parentheses, as in the call **max(x,y)** of function **max** with parameters **x** and **y**. One nuance of such lists is that an empty list of parameters may be found between the terminals ( and ). We may start to develop a grammar for such sequences with the productions:

<sup>2</sup>Technically, *e* can be a string of zero symbols from any alphabet (collection of symbols).

$$\begin{array}{lcl}
 \text{call} & \rightarrow & \text{id ( optparams )} \\
 \text{optparams} & \rightarrow & \text{params } \mid e \\
 \text{params} & \rightarrow & \text{params , param } \mid \text{param}
 \end{array}$$

Note that the second possible body for *optparams* ("optional parameter list") is *e*, which stands for the empty string of symbols. That is, *optparams* can be replaced by the empty string, so a *call* can consist of a function name followed by the two-terminal string (). Notice that the productions for *params* are analogous to those for *list* in Example 2.1, with comma in place of the arithmetic operator + or -, and *param* in place of *digit*. We have not shown the productions for *param*, since parameters are really arbitrary expressions. Shortly, we shall discuss the appropriate productions for the various language constructs, such as expressions, statements, and so on. •

*Parsing* is the problem of taking a string of terminals and figuring out how to derive it from the start symbol of the grammar, and if it cannot be derived from the start symbol of the grammar, then reporting syntax errors within the string. Parsing is one of the most fundamental problems in all of compiling; the main approaches to parsing are discussed in Chapter 4. In this chapter, for simplicity, we begin with source programs like 9-5+2 in which each character is a terminal; in general, a source program has multicharacter lexemes that are grouped by the lexical analyzer into tokens, whose first components are the terminals processed by the parser.

### 2.2.3 Parse Trees

A parse tree pictorially shows how the start symbol of a grammar derives a string in the language. If nonterminal *A* has a production  $A \rightarrow XYZ$ , then a parse tree may have an interior node labeled *A* with three children labeled *X*, *Y*, and *Z*, from left to right:

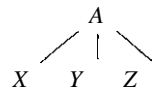

Formally, given a context-free grammar, a *parse tree* according to the grammar is a tree with the following properties:

1. The root is labeled by the start symbol.
2. Each leaf is labeled by a terminal or by *e*.
3. Each interior node is labeled by a nonterminal.
4. If *A* is the nonterminal labeling some interior node and  $X_1, X_2, \dots, X_n$  are the labels of the children of that node from left to right, then there must be a production  $A \rightarrow X_1 X_2 \dots X_n$ . Here,  $X_1, X_2, \dots, X_n$  each stand

## Tree Terminology

Tree data structures figure prominently in compiling.

- A tree consists of one or more *nodes*. Nodes may have *labels*, which in this book typically will be grammar symbols. When we draw a tree, we often represent the nodes by these labels only.
- Exactly one node is the *root*. All nodes except the root have a unique *parent*; the root has no parent. When we draw trees, we place the parent of a node above that node and draw an edge between them. The root is then the highest (top) node.
- If node  $N$  is the parent of node  $M$ , then  $M$  is a *child* of  $N$ . The children of one node are called *siblings*. They have an order, *from the left*, and when we draw trees, we order the children of a given node in this manner.
- A node with no children is called a *leaf*. Other nodes — those with one or more children — are *interior nodes*.
- A *descendant* of a node  $N$  is either  $N$  itself, a child of  $N$ , a child of a child of  $N$ , and so on, for any number of levels. We say node  $N$  is an *ancestor* of node  $M$  if  $M$  is a descendant of  $N$ .

for a symbol that is either a terminal or a nonterminal. As a special case, if  $A \rightarrow e$  is a production, then a node labeled  $A$  may have a single child labeled  $e$ .

**Example 2.4:** The derivation of  $9-5+2$  in Example 2.2 is illustrated by the tree in Fig. 2.5. Each node in the tree is labeled by a grammar symbol. An interior node and its children correspond to a production; the interior node corresponds to the head of the production, the children to the body.

In Fig. 2.5, the root is labeled *list*, the start symbol of the grammar in Example 2.1. The children of the root are labeled, from left to right, *list*, *+*, and *digit*. Note that

$$list \rightarrow list + digit$$

is a production in the grammar of Example 2.1. The left child of the root is similar to the root, with a child labeled *-* instead of *+*. The three nodes labeled *digit* each have one child that is labeled by a digit. •

From left to right, the leaves of a parse tree form the *yield* of the tree, which is the string *generated* or *derived* from the nonterminal at the root of the parse

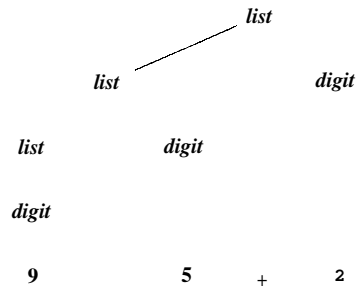

Figure 2.5: Parse tree for 9-5+2 according to the grammar in Example 2.1

tree. In Fig. 2.5, the yield is 9-5+2; for convenience, all the leaves are shown at the bottom level. Henceforth, we shall not necessarily line up the leaves in this way. Any tree imparts a natural left-to-right order to its leaves, based on the idea that if  $X$  and  $Y$  are two children with the same parent, and  $X$  is to the left of  $Y$ , then all descendants of  $X$  are to the left of descendants of  $Y$ .

Another definition of the language generated by a grammar is as the set of strings that can be generated by some parse tree. The process of finding a parse tree for a given string of terminals is called *parsing* that string.

#### 2.2.4 Ambiguity

We have to be careful in talking about *the* structure of a string according to a grammar. A grammar can have more than one parse tree generating a given string of terminals. Such a grammar is said to be *ambiguous*. To show that a grammar is ambiguous, all we need to do is find a terminal string that is the yield of more than one parse tree. Since a string with more than one parse tree usually has more than one meaning, we need to design unambiguous grammars for compiling applications, or to use ambiguous grammars with additional rules to resolve the ambiguities.

**Example 2.5:** Suppose we used a single nonterminal *string* and did not distinguish between digits and lists, as in Example 2.1. We could have written the grammar

$$\textit{string} \rightarrow \textit{string} + \textit{string} \mid \textit{string} - \textit{string} \mid 0 \mid 1 \mid 2 \mid 3 \mid 4 \mid 5 \mid 6 \mid 7 \mid 8 \mid 9$$

Merging the notion of *digit* and *list* into the nonterminal *string* makes superficial sense, because a single *digit* is a special case of a *list*.

However, Fig. 2.6 shows that an expression like 9-5+2 has more than one parse tree with this grammar. The two trees for 9-5+2 correspond to the two ways of parenthesizing the expression: (9-5)+2 and 9-(5+2). This second parenthesization gives the expression the unexpected value 2 rather than the customary value 6. The grammar of Example 2.1 does not permit this interpretation. •

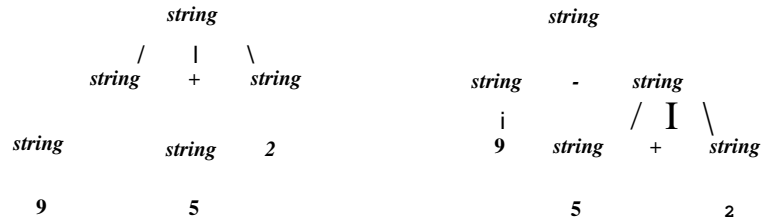
Figure 2.6: Two parse trees for  $9-5+2$ 

## 2.2.5 Associativity of Operators

By convention,  $9+5+2$  is equivalent to  $(9+5)+2$  and  $9-5-2$  is equivalent to  $(9-5)-2$ . When an operand like **5** has operators to its left and right, conventions are needed for deciding which operator applies to that operand. We say that the operator  $+$  *associates* to the left, because an operand with plus signs on both sides of it belongs to the operator to its left. In most programming languages the four arithmetic operators, addition, subtraction, multiplication, and division are left-associative.

Some common operators such as exponentiation are right-associative. As another example, the assignment operator  $=$  in C and its descendants is right-associative; that is, the expression  $a=b=c$  is treated in the same way as the expression  $a=(b=c)$ .

Strings like  $a=b=c$  with a right-associative operator are generated by the following grammar:

$$\begin{aligned} \textit{right} &\rightarrow \bullet \textit{letter} = \textit{right} \mid \textit{letter} \\ \textit{letter} &\rightarrow \mathbf{a} \mid \mathbf{b} \mid \bullet \bullet \bullet \mid \mathbf{z} \end{aligned}$$

The contrast between a parse tree for a left-associative operator like  $-$  and a parse tree for a right-associative operator like  $=$  is shown by Fig. 2.7. Note that the parse tree for  $9-5-2$  grows down towards the left, whereas the parse tree for  $a=b=c$  grows down towards the right.

## 2.2.6 Precedence of Operators

Consider the expression  $9+5*2$ . There are two possible interpretations of this expression:  $(9+5)*2$  or  $9+(5*2)$ . The associativity rules for  $+$  and  $*$  apply to occurrences of the same operator, so they do not resolve this ambiguity. Rules defining the relative precedence of operators are needed when more than one kind of operator is present.

We say that  $*$  has *higher precedence* than  $+$  if  $*$  takes its operands before  $+$  does. In ordinary arithmetic, multiplication and division have higher precedence than addition and subtraction. Therefore, **5** is taken by  $*$  in both  $9+5*2$  and  $9*5+2$ ; i.e., the expressions are equivalent to  $9+(5*2)$  and  $(9*5)+2$ , respectively.

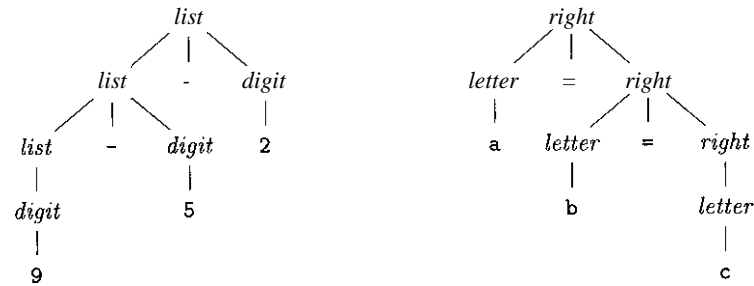

Figure 2.7: Parse trees for left- and right-associative grammars

**Example 2.6 :** A grammar for arithmetic expressions can be constructed from a table showing the associativity and precedence of operators. We start with the four common arithmetic operators and a precedence table, showing the operators in order of increasing precedence. Operators on the same line have the same associativity and precedence:

left-associative: + -  
 left-associative: \* /

We create two nonterminals *expr* and *term* for the two levels of precedence, and an extra nonterminal *factor* for generating basic units in expressions. The basic units in expressions are presently digits and parenthesized expressions.

*factor*  $\rightarrow$  **digit** | ( *expr* )

Now consider the binary operators, \* and /, that have the highest precedence. Since these operators associate to the left, the productions are similar to those for lists that associate to the left.

*term*  $\rightarrow$  *term* \* *factor*  
 | *term* / *factor*  
 | *factor*

Similarly, *expr* generates lists of terms separated by the additive operators.

*expr*  $\rightarrow$  *expr* + *term*  
 | *expr* - *term*  
 | *term*

The resulting grammar is therefore

*expr*  $\rightarrow$  *expr* + *term* | *expr* - *term* | *term*  
*term*  $\rightarrow$  *term* \* *factor* | *term* / *factor* | *factor*  
*factor*  $\rightarrow$  **digit** | ( *expr* )



## Generalizing the Expression Grammar of Example 2.6

We can think of a factor as an expression that cannot be "torn apart" by any operator. By "torn apart," we mean that placing an operator next to any factor, on either side, does not cause any piece of the factor, other than the whole, to become an operand of that operator. If the factor is a parenthesized expression, the parentheses protect against such "tearing," while if the factor is a single operand, it cannot be torn apart.

A term (that is not also a factor) is an expression that can be torn apart by operators of the highest precedence:  $*$  and  $/$ , but not by the lower-precedence operators. An expression (that is not a term or factor) can be torn apart by any operator.

We can generalize this idea to any number  $n$  of precedence levels. We need  $n+1$  nonterminals. The first, like *factor* in Example 2.6, can never be torn apart. Typically, the production bodies for this nonterminal are only single operands and parenthesized expressions. Then, for each precedence level, there is one nonterminal representing expressions that can be torn apart only by operators at that level or higher. Typically, the productions for this nonterminal have bodies representing uses of the operators at that level, plus one body that is just the nonterminal for the next higher level.

With this grammar, an expression is a list of terms separated by either  $+$  or  $-$  signs, and a term is a list of factors separated by  $*$  or  $/$  signs. Notice that any parenthesized expression is a factor, so with parentheses we can develop expressions that have arbitrarily deep nesting (and arbitrarily deep trees). •

**Example 2.7:** Keywords allow us to recognize statements, since most statements begin with a keyword or a special character. Exceptions to this rule include assignments and procedure calls. The statements defined by the (ambiguous) grammar in Fig. 2.8 are legal in Java.

In the first production for *stmt*, the terminal **id** represents any identifier. The productions for *expression* are not shown. The assignment statements specified by the first production are legal in Java, although Java treats  $=$  as an assignment operator that can appear within an expression. For example, Java allows  $\mathbf{a} = \mathbf{b} = \mathbf{c}$ , which this grammar does not.

The nonterminal *stmts* generates a possibly empty list of statements. The second production for *stmts* generates the empty list  $\epsilon$ . The first production generates a possibly empty list of statements followed by a statement.

The placement of semicolons is subtle; they appear at the end of every body that does not end in *stmt*. This approach prevents the build-up of semicolons after statements such as *if*- and *while*-, which end with nested substatements. When the nested substatement is an assignment or a *do-while*, a semicolon will be generated as part of the substatement. •

```

stmt  →  id = expression ;
        |  if ( expression ) sraŕ
        |  if ( expression ) stmi else stmt
        |  while ( expression ) sirai
        |  do stmt while ( expression ) ;
        |  { stmts }

stmts →  sŕmfs sŕraŕ

```

Figure 2.8: A grammar for a subset of Java statements

### 2.2.7 Exercises for Section 2.2

**Exercise 2.2.1:** Consider the context-free grammar

$$S \rightarrow 55+ \mid 55* \mid a$$

- Show how the string **aa+a\*** can be generated by this grammar.
- Construct a parse tree for this string.
- What language does this grammar generate? Justify your answer.

**Exercise 2.2.2:** What language is generated by the following grammars? In each case justify your answer.

- $5 \rightarrow 5 \mid 0 \mid 5 \mid 1 \mid 0 \mid 1$
- $5 \rightarrow 5 + 5 \mid - 5 \mid a$
- $5 \rightarrow 5 ( 5 ) 5 \mid e$
- $5 \rightarrow a 5 b 5 \mid b 5 a 5 \mid e$
- $5 \rightarrow a \mid 5 + 5 \mid 5 5 \mid 5 * \mid ( 5 )$

**Exercise 2.2.3:** Which of the grammars in Exercise 2.2.2 are ambiguous?

**Exercise 2.2.4:** Construct unambiguous context-free grammars for each of the following languages. In each case show that your grammar is correct.

- Arithmetic expressions in postfix notation.
- Left-associative lists of identifiers separated by commas.
- Right-associative lists of identifiers separated by commas.
- Arithmetic expressions of integers and identifiers with the four binary operators  $+$ ,  $-$ ,  $*$ ,  $/$ .

! e) Add unary plus and minus to the arithmetic operators of (d).

**Exercise 2.2.5:**

- a) Show that all binary strings generated by the following grammar have values divisible by 3. *Hint.* Use induction on the number of nodes in a parse tree.

$$\text{num} \rightarrow 11 \mid 1001 \mid \text{num}0 \mid \text{num num}$$

- b) Does the grammar generate all binary strings with values divisible by 3?

**Exercise 2.2.6:** Construct a context-free grammar for roman numerals.

## 2.3 Syntax-Directed Translation

Syntax-directed translation is done by attaching rules or program fragments to productions in a grammar. For example, consider an expression  $expr$  generated by the production

$$expr \rightarrow expr_1 + term$$

Here,  $expr$  is the sum of the two subexpressions  $expr_1$  and  $term$ . (The subscript in  $expr_1$  is used only to distinguish the instance of  $expr$  in the production body from the head of the production). We can translate  $expr$  by exploiting its structure, as in the following pseudo-code:

```
translate expr;  
translate term;  
handle +;
```

Using a variant of this pseudocode, we shall build a syntax tree for  $expr$  in Section 2.8 by building syntax trees for  $expr_1$  and  $term$  and then handling  $+$  by constructing a node for it. For convenience, the example in this section is the translation of infix expressions into postfix notation.

This section introduces two concepts related to syntax-directed translation:

- *Attributes.* An *attribute* is any quantity associated with a programming construct. Examples of attributes are data types of expressions, the number of instructions in the generated code, or the location of the first instruction in the generated code for a construct, among many other possibilities. Since we use grammar symbols (nonterminals and terminals) to represent programming constructs, we extend the notion of attributes from constructs to the symbols that represent them.

- (*Syntax-directed translation schemes.* A *translation scheme* is a notation for attaching program fragments to the productions of a grammar. The program fragments are executed when the production is used during syntax analysis. The combined result of all these fragment executions, in the order induced by the syntax analysis, produces the translation of the program to which this analysis/synthesis process is applied.

Syntax-directed translations will be used throughout this chapter to translate infix expressions into postfix notation, to evaluate expressions, and to build syntax trees for programming constructs. A more detailed discussion of syntax-directed formalisms appears in Chapter 5.

### 2.3.1 Postfix Notation

The examples in this section deal with translation into postfix notation. The *postfix notation* for an expression  $E$  can be defined inductively as follows:

1. If  $E$  is a variable or constant, then the postfix notation for  $E$  is  $E$  itself.
2. If  $E$  is an expression of the form  $E_1 \text{ op } E_2$ , where **op** is any binary operator, then the postfix notation for  $E$  is  $E_1 E_2 \text{ op}$ , where  $E_1$  and  $E_2$  are the postfix notations for  $E_1$  and  $E_2$ , respectively.
3. If  $E$  is a parenthesized expression of the form  $(E_1)$ , then the postfix notation for  $E$  is the same as the postfix notation for  $E_1$ .

**Example 2.8:** The postfix notation for  $(9-5)+2$  is **95-2+**. That is, the translations of **9**, **5**, and **2** are the constants themselves, by rule (1). Then, the translation of **9-5** is **95-** by rule (2). The translation of  $(9-5)$  is the same by rule (3). Having translated the parenthesized subexpression, we may apply rule (2) to the entire expression, with  $(9-5)$  in the role of  $E_1$  and **2** in the role of  $E_2$  to get the result **95-2+**.

As another example, the postfix notation for  $9-(5+2)$  is **952+-**. That is, **5+2** is first translated into **52+**, and this expression becomes the second argument of the minus sign. •

No parentheses are needed in postfix notation, because the position and *arity* (number of arguments) of the operators permits only one decoding of a postfix expression. The "trick" is to repeatedly scan the postfix string from the left, until you find an operator. Then, look to the left for the proper number of operands, and group this operator with its operands. Evaluate the operator on the operands, and replace them by the result. Then repeat the process, continuing to the right and searching for another operator.

**Example 2.9:** Consider the postfix expression **952+-3\***. Scanning from the left, we first encounter the plus sign. Looking to its left we find operands **5** and **2**. Their sum, **7**, replaces **52+**, and we have the string **97-3\***. Now, the leftmost

operator is the minus sign, and its operands are **9** and **7**. Replacing these by the result of the subtraction leaves **23\***. Last, the multiplication sign applies to **2** and **3**, giving the result **6**. •

### 2.3.2 Synthesized Attributes

The idea of associating quantities with programming constructs—for example, values and types with expressions—can be expressed in terms of grammars. We associate attributes with nonterminals and terminals. Then, we attach rules to the productions of the grammar; these rules describe how the attributes are computed at those nodes of the parse tree where the production in question is used to relate a node to its children.

A *syntax-directed definition* associates

1. With each grammar symbol, a set of attributes, and
2. With each production, a set of *semantic rules* for computing the values of the attributes associated with the symbols appearing in the production.

Attributes can be evaluated as follows. For a given input string  $x$ , construct a parse tree for  $x$ . Then, apply the semantic rules to evaluate attributes at each node in the parse tree, as follows.

Suppose a node  $A^i$  in a parse tree is labeled by the grammar symbol  $X$ . We write  $X.a$  to denote the value of attribute  $a$  of  $X$  at that node. A parse tree showing the attribute values at each node is called an *annotated* parse tree. For example, Fig. 2.9 shows an annotated parse tree for **9-5+2** with an attribute  $t$  associated with the nonterminals *expr* and *term*. The value **95-2+** of the attribute at the root is the postfix notation for **9-5+2**. We shall see shortly how these expressions are computed.

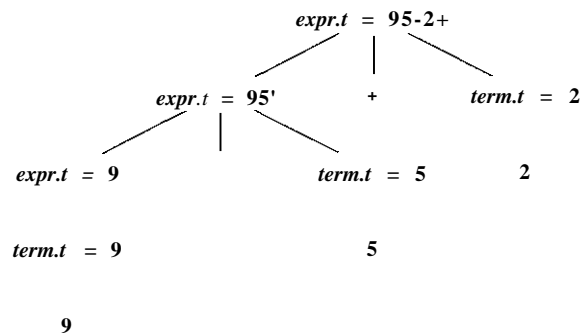

Figure 2.9: Attribute values at nodes in a parse tree

An attribute is said to be *synthesized* if its value at a parse-tree node  $N$  is determined from attribute values at the children of  $N$  and at  $N$  itself. Synthesized

attributes have the desirable property that they can be evaluated during a single bottom-up traversal of a parse tree. In Section 5.1.1 we shall discuss another important kind of attribute: the "inherited" attribute. Informally, inherited attributes have their value at a parse-tree node determined from attribute values at the node itself, its parent, and its siblings in the parse tree.

**Example 2.10:** The annotated parse tree in Fig. 2.9 is based on the syntax-directed definition in Fig. 2.10 for translating expressions consisting of digits separated by plus or minus signs into postfix notation. Each nonterminal has a string-valued attribute  $t$  that represents the postfix notation for the expression generated by that nonterminal in a parse tree. The symbol  $\|$  in the semantic rule is the operator for string concatenation.

PRODUCTION	SEMANTIC RULES
$expr \rightarrow expr_1 + term$	$expr.t = expr_1.t \  term.t \  '+'$
$expr \rightarrow expr_1 - term$	$expr.t = expr_1.t \  term.t \  '-'$
$expr \rightarrow term$	$expr.t = term.t$
$term \rightarrow 0$	$term.t = '0'$
$term \rightarrow 1$	$term.t = '1'$
$term \rightarrow \dots 9$	$term.t = '9'$

Figure 2.10: Syntax-directed definition for infix to postfix translation

The postfix form of a digit is the digit itself; e.g., the semantic rule associated with the production  $term \rightarrow 9$  defines  $term.t$  to be 9 itself whenever this production is used at a node in a parse tree. The other digits are translated similarly. As another example, when the production  $expr \rightarrow term$  is applied, the value of  $term.t$  becomes the value of  $expr.t$ .

The production  $expr \rightarrow expr_1 + term$  derives an expression containing a plus operator.<sup>3</sup> The left operand of the plus operator is given by  $expr_1$  and the right operand by  $term$ . The semantic rule

$$expr.t = expr_1.t \| term.t \| '+'$$

associated with this production constructs the value of attribute  $expr.t$  by concatenating the postfix forms  $expr_1.t$  and  $term.t$  of the left and right operands, respectively, and then appending the plus sign. This rule is a formalization of the definition of "postfix expression." •

<sup>3</sup>In this and many other rules, the same nonterminal ( $expr$ , here) appears several times. The purpose of the subscript 1 in  $expr_1$  is to distinguish the two occurrences of  $expr$  in the production; the "1" is not part of the nonterminal. See the box on "Convention Distinguishing Uses of a Nonterminal" for more details.

### Convention Distinguishing Uses of a Nonterminal

In rules, we often have a need to distinguish among several uses of the same nonterminal in the head and/or body of a production; e.g., see Example 2.10. The reason is that in the parse tree, different nodes labeled by the same nonterminal usually have different values for their translations. We shall adopt the following convention: the nonterminal appears unsubscripted in the head and with distinct subscripts in the body. These are all occurrences of the same nonterminal, and the subscript is not part of its name. However, the reader should be alert to the difference between examples of specific translations, where this convention is used, and generic productions like  $A \rightarrow XIX_2, \dots, X_n$ , where the subscripted  $X$ 's represent an arbitrary list of grammar symbols, and are *not* instances of one particular nonterminal called  $X$ .

### 2.3.3 Simple Syntax-Directed Definitions

The syntax-directed definition in Example 2.10 has the following important property: the string representing the translation of the nonterminal at the head of each production is the concatenation of the translations of the nonterminals in the production body, in the same order as in the production, with some optional additional strings interleaved. A syntax-directed definition with this property is termed *simple*.

**Example 2.11:** Consider the first production and semantic rule from Fig. 2.10:

$$\begin{array}{ll} \text{PRODUCTION} & \text{SEMANTIC RULE} \\ \text{expr}^r \text{ expr}_i + \text{term} & \text{expr.t} = \text{expr.t} \parallel \text{term.t} \parallel '+' \end{array} \quad (2.5)$$

Here the translation  $\text{expr.t}$  is the concatenation of the translations of  $\text{expr}_i$  and  $\text{term}$ , followed by the symbol  $+$ . Notice that  $\text{expr}_i$  and  $\text{term}$  appear in the same order in both the production body and the semantic rule. There are no additional symbols before or between their translations. In this example, the only extra symbol occurs at the end. •

When translation schemes are discussed, we shall see that a simple syntax-directed definition can be implemented by printing only the additional strings, in the order they appear in the definition.

### 2.3.4 Tree Traversals

Tree traversals will be used for describing attribute evaluation and for specifying the execution of code fragments in a translation scheme. A *traversal* of a tree starts at the root and visits each node of the tree in some order.

A *depth-first* traversal starts at the root and recursively visits the children of each node in any order, not necessarily from left to right. It is called "depth-first" because it visits an unvisited child of a node whenever it can, so it visits nodes as far away from the root (as "deep") as quickly as it can.

The procedure *visit(N)* in Fig. 2.11 is a depth first traversal that visits the children of a node in left-to-right order, as shown in Fig. 2.12. In this traversal, we have included the action of evaluating translations at each node, just before we finish with the node (that is, after translations at the children have surely been computed). In general, the actions associated with a traversal can be whatever we choose, or nothing at all.

```

procedure visit (node N) {
    for ( each child C of N, from left to right ) {
        visit (C);
    }
    evaluate semantic rules at node N;
}

```

Figure 2.11: A depth-first traversal of a tree

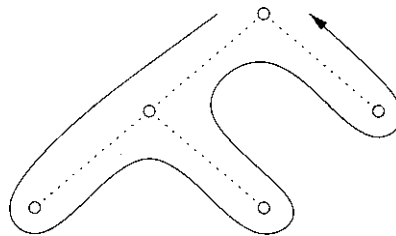

Figure 2.12: Example of a depth-first traversal of a tree

A syntax-directed definition does not impose any specific order for the evaluation of attributes on a parse tree; any evaluation order that computes an attribute  $a$  after all the other attributes that  $a$  depends on is acceptable. Synthesized attributes can be evaluated during any *bottom-up* traversal, that is, a traversal that evaluates attributes at a node after having evaluated attributes at its children. In general, with both synthesized and inherited attributes, the matter of evaluation order is quite complex; see Section 5.2.

### 2.3.5 Translation Schemes

The syntax-directed definition in Fig. 2.10 builds up a translation by attaching strings as attributes to the nodes in the parse tree. We now consider an alternative approach that does not need to manipulate strings; it produces the same translation incrementally, by executing program fragments.



## Preorder and Postorder Traversals

Preorder and postorder traversals are two important special cases of depth-first traversals in which we visit the children of each node from left to right.

Often, we traverse a tree to perform some particular action at each node. If the action is done when we first visit a node, then we may refer to the traversal as a *preorder traversal*. Similarly, if the action is done just before we leave a node for the last time, then we say it is a *postorder traversal* of the tree. The procedure *visit(N)* in Fig. 2.11 is an example of a postorder traversal.

Preorder and postorder traversals define corresponding orderings on nodes, based on when the action at a node would be performed. The *preorder* of a (sub)tree rooted at node *JV* consists of *N*, followed by the preorders of the subtrees of each of its children, if any, from the left. The *postorder* of a (sub)tree rooted at *TV* consists of the postorders of each of the subtrees for the children of *N*, if any, from the left, followed by *N* itself.

A syntax-directed translation scheme is a notation for specifying a translation by attaching program fragments to productions in a grammar. A translation scheme is like a syntax-directed definition, except that the order of evaluation of the semantic rules is explicitly specified.

Program fragments embedded within production bodies are called *semantic actions*. The position at which an action is to be executed is shown by enclosing it between curly braces and writing it within the production body, as in

$$rest \rightarrow + term \{ \text{print('+')} \} rest \setminus$$

We shall see such rules when we consider an alternative form of grammar for expressions, where the nonterminal *rest* represents "everything but the first term of an expression." This form of grammar is discussed in Section 2.4.5. Again, the subscript in *rest\* distinguishes this instance of nonterminal *rest* in the production body from the instance of *rest* at the head of the production.

When drawing a parse tree for a translation scheme, we indicate an action by constructing an extra child for it, connected by a dashed line to the node that corresponds to the head of the production. For example, the portion of the parse tree for the above production and action is shown in Fig. 2.13. The node for a semantic action has no children, so the action is performed when that node is first seen.

**Example 2.12:** The parse tree in Fig. 2.14 has print statements at extra leaves, which are attached by dashed lines to interior nodes of the parse tree. The translation scheme appears in Fig. 2.15. The underlying grammar generates expressions consisting of digits separated by plus and minus signs. The

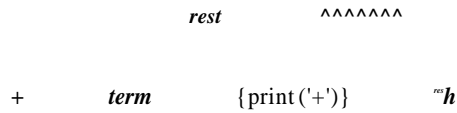

Figure 2.13: An extra leaf is constructed for a semantic action

actions embedded in the production bodies translate such expressions into postfix notation, provided we perform a left-to-right depth-first traversal of the tree and execute each print statement when we visit its leaf.

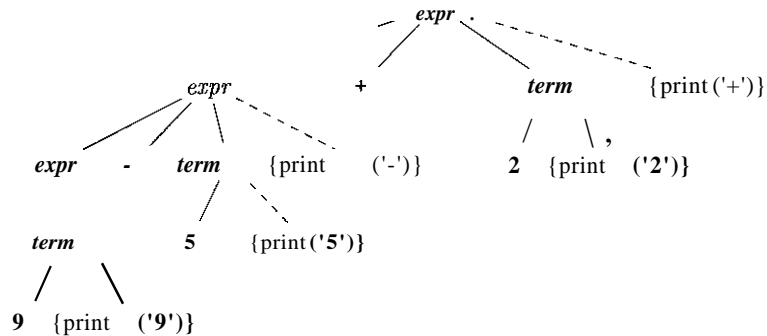

Figure 2.14: Actions translating 9-5+2 into 95-2+

<i>expr</i>	$\rightarrow$	<i>expr</i> <sub>1</sub> + <i>term</i>	{print('+')}
<i>expr</i>	$\rightarrow$	<i>expr</i> <sub>1</sub> - <i>term</i>	{print('-')}
<i>expr</i>	$\rightarrow$	<i>term</i>	
<i>term</i>	$\rightarrow$	0	{print('0')}
<i>term</i>	$\rightarrow$	1	{print('1')}
<i>term</i>	$\rightarrow$	9	{print('9')}

Figure 2.15: Actions for translating into postfix notation

The root of Fig. 2.14 represents the first production in Fig. 2.15. In a postorder traversal, we first perform all the actions in the leftmost subtree of the root, for the left operand, also labeled *expr* like the root. We then visit the leaf + at which there is no action. We next perform the actions in the subtree for the right operand *term* and, finally, the semantic action { print('+') } at the extra node.

Since the productions for *term* have only a digit on the right side, that digit is printed by the actions for the productions. No output is necessary for the production *expr*  $\rightarrow$  *term*, and only the operator needs to be printed in the

action for each of the first two productions. When executed during a postorder traversal of the parse tree, the actions in Fig. 2.14 print 95-2+. •

Note that although the schemes in Fig. 2.10 and Fig. 2.15 produce the same translation, they construct it differently; Fig. 2.10 attaches strings as attributes to the nodes in the parse tree, while the scheme in Fig. 2.15 prints the translation incrementally, through semantic actions.

The semantic actions in the parse tree in Fig. 2.14 translate the infix expression 9-5+2 into 95-2+ by printing each character in 9-5+2 exactly once, without using any storage for the translation of subexpressions. When the output is created incrementally in this fashion, the order in which the characters are printed is significant.

The implementation of a translation scheme must ensure that semantic actions are performed in the order they would appear during a postorder traversal of a parse tree. The implementation need not actually construct a parse tree (often it does not), as long as it ensures that the semantic actions are performed as if we constructed a parse tree and then executed the actions during a postorder traversal.

### 2.3.6 Exercises for Section 2.3

**Exercise 2.3.1:** Construct a syntax-directed translation scheme that translates arithmetic expressions from infix notation into prefix notation in which an operator appears before its operands; e.g.,  $-xy$  is the prefix notation for  $x - y$ . Give annotated parse trees for the inputs 9-5+2 and 9-5\*2.

**Exercise 2.3.2:** Construct a syntax-directed translation scheme that translates arithmetic expressions from postfix notation into infix notation. Give annotated parse trees for the inputs 95-2\* and 952\*-.

**Exercise 2.3.3:** Construct a syntax-directed translation scheme that translates integers into roman numerals.

**Exercise 2.3.4:** Construct a syntax-directed translation scheme that translates roman numerals into integers.

**Exercise 2.3.5:** Construct a syntax-directed translation scheme that translates postfix arithmetic expressions into equivalent infix arithmetic expressions.

## 2.4 Parsing

Parsing is the process of determining how a string of terminals can be generated by a grammar. In discussing this problem, it is helpful to think of a parse tree being constructed, even though a compiler may not construct one, in practice. However, a parser must be capable of constructing the tree in principle, or else the translation cannot be guaranteed correct.

This section introduces a parsing method called "recursive descent," which can be used both to parse and to implement syntax-directed translators. A complete Java program, implementing the translation scheme of Fig. 2.15, appears in the next section. A viable alternative is to use a software tool to generate a translator directly from a translation scheme. Section 4.9 describes such a tool — Yacc; it can implement the translation scheme of Fig. 2.15 without modification.

For any context-free grammar there is a parser that takes at most  $O(n^3)$  time to parse a string of  $n$  terminals. But cubic time is generally too expensive. Fortunately, for real programming languages, we can generally design a grammar that can be parsed quickly. Linear-time algorithms suffice to parse essentially all languages that arise in practice. Programming-language parsers almost always make a single left-to-right scan over the input, looking ahead one terminal at a time, and constructing pieces of the parse tree as they go.

Most parsing methods fall into one of two classes, called the *top-down* and *bottom-up* methods. These terms refer to the order in which nodes in the parse tree are constructed. In top-down parsers, construction starts at the root and proceeds towards the leaves, while in bottom-up parsers, construction starts at the leaves and proceeds towards the root. The popularity of top-down parsers is due to the fact that efficient parsers can be constructed more easily by hand using top-down methods. Bottom-up parsing, however, can handle a larger class of grammars and translation schemes, so software tools for generating parsers directly from grammars often use bottom-up methods.

### 2.4.1 Top-Down Parsing

We introduce top-down parsing by considering a grammar that is well-suited for this class of methods. Later in this section, we consider the construction of top-down parsers in general. The grammar in Fig. 2.16 generates a subset of the statements of C or Java. We use the boldface terminals **if** and **for** for the keywords "if" and "for", respectively, to emphasize that these character sequences are treated as units, i.e., as single terminal symbols. Further, the terminal **expr** represents expressions; a more complete grammar would use a nonterminal *expr* and have productions for nonterminal *expr*. Similarly, **other** is a terminal representing other statement constructs.

The top-down construction of a parse tree like the one in Fig. 2.17, is done by starting with the root, labeled with the starting nonterminal *stmt*, and repeatedly performing the following two steps.

1. At node JV, labeled with nonterminal *A*, select one of the productions for *A* and construct children at *N* for the symbols in the production body.
2. Find the next node at which a subtree is to be constructed, typically the leftmost unexpanded nonterminal of the tree.

For some grammars, the above steps can be implemented during a single left-to-right scan of the input string. The current terminal being scanned in the

$$\begin{array}{l}
 stmt \rightarrow \mathbf{expr} ; \\
 \quad \mathbf{if} ( \mathbf{expr} ) stmt \\
 \quad \mathbf{for} ( optexpr ; optexpr ; optexpr ) stmt \\
 \quad \mathbf{other} \\
 \\
 optexpr \rightarrow e \\
 \quad \mathbf{expr}
 \end{array}$$

Figure 2.16: A grammar for some statements in C and Java

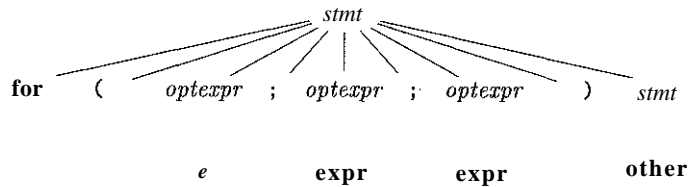

Figure 2.17: A parse tree according to the grammar in Fig. 2.16

input is frequently referred to as the *lookahead* symbol. Initially, the lookahead symbol is the first, i.e., leftmost, terminal of the input string. Figure 2.18 illustrates the construction of the parse tree in Fig. 2.17 for the input string

**for ( ; expr ; expr ) other**

Initially, the terminal **for** is the lookahead symbol, and the known part of the parse tree consists of the root, labeled with the starting nonterminal *stmt* in Fig. 2.18(a). The objective is to construct the remainder of the parse tree in such a way that the string generated by the parse tree matches the input string.

For a match to occur, the nonterminal *stmt* in Fig. 2.18(a) must derive a string that starts with the lookahead symbol **for**. In the grammar of Fig. 2.16, there is just one production for *stmt* that can derive such a string, so we select it, and construct the children of the root labeled with the symbols in the production body. This expansion of the parse tree is shown in Fig. 2.18(b).

Each of the three snapshots in Fig. 2.18 has arrows marking the lookahead symbol in the input and the node in the parse tree that is being considered. Once children are constructed at a node, we next consider the leftmost child. In Fig. 2.18(b), children have just been constructed at the root, and the leftmost child labeled with **for** is being considered.

When the node being considered in the parse tree is for a terminal, and the terminal matches the lookahead symbol, then we advance in both the parse tree and the input. The next terminal in the input becomes the new lookahead symbol, and the next child in the parse tree is considered. In Fig. 2.18(c), the arrow in the parse tree has advanced to the next child of the root, and the arrow

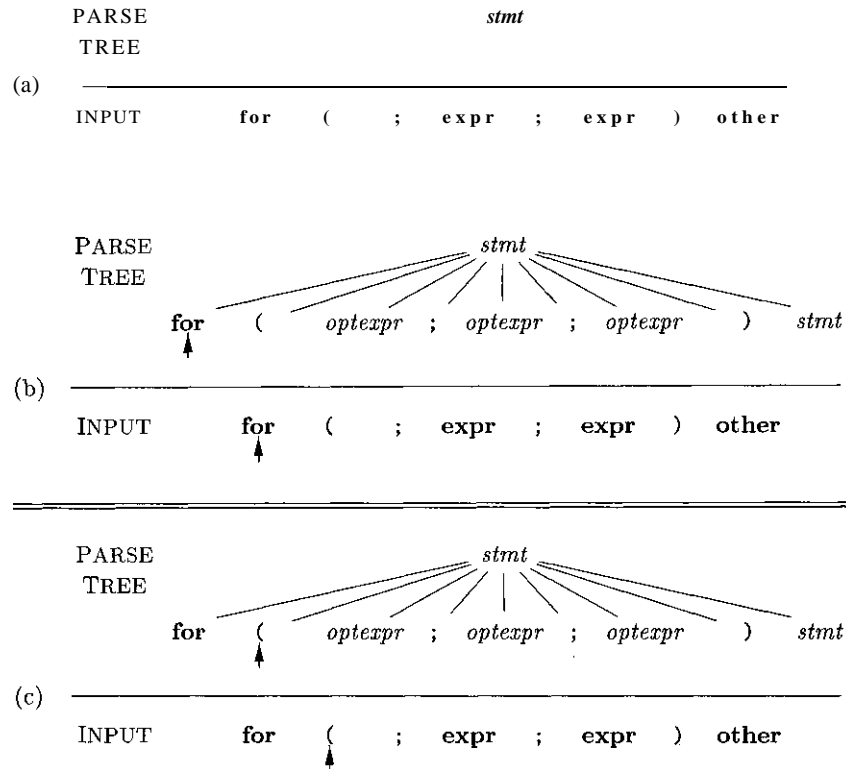

Figure 2.18: Top-down parsing while scanning the input from left to right

in the input has advanced to the next terminal, which is (. A further advance will take the arrow in the parse tree to the child labeled with nonterminal *optexpr* and take the arrow in the input to the terminal ;.

At the nonterminal node labeled *optexpr*, we repeat the process of selecting a production for a nonterminal. Productions with  $\epsilon$  as the body (" $\epsilon$ -productions") require special treatment. For the moment, we use them as a default when no other production can be used; we return to them in Section 2.4.3. With nonterminal *optexpr* and lookahead ;, the  $\epsilon$ -production is used, since ; does not match the only other production for *optexpr*, which has terminal **expr** as its body.

In general, the selection of a production for a nonterminal may involve trial-and-error; that is, we may have to try a production and backtrack to try another production if the first is found to be unsuitable. A production is unsuitable if, after using the production, we cannot complete the tree to match the input

string. Backtracking is not needed, however, in an important special case called predictive parsing, which we discuss next.

## 2.4.2 Predictive Parsing

*Recursive-descent parsing* is a top-down method of syntax analysis in which a set of recursive procedures is used to process the input. One procedure is associated with each nonterminal of a grammar. Here, we consider a simple form of recursive-descent parsing, called *predictive parsing*, in which the lookahead symbol unambiguously determines the flow of control through the procedure body for each nonterminal. The sequence of procedure calls during the analysis of an input string implicitly defines a parse tree for the input, and can be used to build an explicit parse tree, if desired.

The predictive parser in Fig. 2.19 consists of procedures for the nonterminals *stmt* and *optexpr* of the grammar in Fig. 2.16 and an additional procedure *match*, used to simplify the code for *stmt* and *optexpr*. Procedure *match(t)* compares its argument *t* with the lookahead symbol and advances to the next input terminal if they match. Thus *match* changes the value of variable *lookahead*, a global variable that holds the currently scanned input terminal.

Parsing begins with a call of the procedure for the starting nonterminal *stmt*. With the same input as in Fig. 2.18, *lookahead* is initially the first terminal **for**. Procedure *stmt* executes code corresponding to the production

$$stmt \rightarrow \mathbf{for} \ ( \ optexpr \ ; \ optexpr \ ; \ optexpr \ ) \ stmt$$

In the code for the production body — that is, the **for** case of procedure *stmt* — each terminal is matched with the lookahead symbol, and each nonterminal leads to a call of its procedure, in the following sequence of calls:

```

match(for);    matched);
optexprQ;    match(';');    optexprQ;    match(';');    optexprQ;
match(')');    stmtQ;

```

Predictive parsing relies on information about the first symbols that can be generated by a production body. More precisely, let *a* be a string of grammar symbols (terminals and/or nonterminals). We define **FIRST**(*a*) to be the set of terminals that appear as the first symbols of one or more strings of terminals generated from *a*. If *a* is *e* or can generate *e*, then *e* is also in **FIRST**(*a*).

The details of how one computes **FIRST**(*a*) are in Section 4.4.2. Here, we shall just use ad hoc reasoning to deduce the symbols in **FIRST**(*a*); typically, *a* will either begin with a terminal, which is therefore the only symbol in **FIRST**(*a*), or *a* will begin with a nonterminal whose production bodies begin with terminals, in which case these terminals are the only members of **FIRST**(*a*).

For example, with respect to the grammar of Fig. 2.16, the following are correct calculations of **FIRST**.

```

void stmt() {
    switch ( lookahead ) {
    case expr:
        match(expr);  match(';');  break;
    case if:
        match(if);  match(' ( ');  match (expr);  match(')');  stmtQ;
        break;
    case for:
        match(for);  match(' ( ');
        optexprQ;  match(';');  optexpr();  match(';');  optexprQ;
        match(')');  stmtQ;  break;
    case other:
        match (other);  break;
    default:
        report ("syntax error");
    }
}

void optexpr() {
    if ( lookahead == expr ) match(expr);
}

void match(terminal £) {
    if ( lookahead == £ ) lookahead — next Terminal;
    else report ("syntax error");
}

```

Figure 2.19: Pseudocode for a predictive parser

$$\begin{aligned} \mathbf{FIRST}(\text{stmt}) &= \{\mathbf{expr}, \mathbf{if}, \mathbf{for}, \mathbf{other}\} \\ \mathbf{FIRST}(\mathbf{expr} \ ;) &= \{\mathbf{expr}\} \end{aligned}$$

The **FIRST** sets must be considered if there are two productions  $A \rightarrow a$  and  $A \rightarrow \theta$ . Ignoring e-productions for the moment, predictive parsing requires **FIRST**(a) and **FIRST**( $\theta$ ) to be disjoint. The lookahead symbol can then be used to decide which production to use; if the lookahead symbol is in **FIRST**( $\theta$ ), then  $a$  is used. Otherwise, if the lookahead symbol is in **FIRST**(a), then  $\theta$  is used.

### 2.4.3 When to Use e-Productions

Our predictive parser uses an e-production as a default when no other production can be used. With the input of Fig. 2.18, after the terminals **for** and ( are matched, the lookahead symbol is ;. At this point procedure *optexpr* is called, and the code



```
if ( lookahead === expr ) match(expr);
```

in its body is executed. Nonterminal *optexpr* has two productions, with bodies **expr** and *e*. The lookahead symbol ";" does not match the terminal **expr**, so the production with body **expr** cannot apply. In fact, the procedure returns without changing the lookahead symbol or doing anything else. Doing nothing corresponds to applying an *e*-production.

More generally, consider a variant of the productions in Fig. 2.16 where *optexpr* generates an expression nonterminal instead of the terminal **expr**:

$$\text{optexpr} \xrightarrow{\bullet} \begin{array}{c} \text{expr} \\ \text{I} \\ e \end{array}$$

Thus, *optexpr* either generates an expression using nonterminal *expr* or it generates *e*. While parsing *optexpr*, if the lookahead symbol is not in FIRST(*expr*), then the *e*-production is used.

For more on when to use *e*-productions, see the discussion of LL(1) grammars in Section 4.4.3.

## 2.4.4 Designing a Predictive Parser

We can generalize the technique introduced informally in Section 2.4.2, to apply to any grammar that has disjoint FIRST sets for the production bodies belonging to any nonterminal. We shall also see that when we have a translation scheme — that is, a grammar with embedded actions — it is possible to execute those actions as part of the procedures designed for the parser.

Recall that a *predictive parser* is a program consisting of a procedure for every nonterminal. The procedure for nonterminal *A* does two things.

1. It decides which *A*-production to use by examining the lookahead symbol. The production with body *a* (where *a* is not *e*, the empty string) is used if the lookahead symbol is in FIRST(*a*). If there is a conflict between two nonempty bodies for any lookahead symbol, then we cannot use this parsing method on this grammar. In addition, the *e*-production for *A*, if it exists, is used if the lookahead symbol is not in the FIRST set for any other production body for *A*.
2. The procedure then mimics the body of the chosen production. That is, the symbols of the body are "executed" in turn, from the left. A nonterminal is "executed" by a call to the procedure for that nonterminal, and a terminal matching the lookahead symbol is "executed" by reading the next input symbol. If at some point the terminal in the body does not match the lookahead symbol, a syntax error is reported.

Figure 2.19 is the result of applying these rules to the grammar in Fig. 2.16.

Just as a translation scheme is formed by extending a grammar, a syntax-directed translator can be formed by extending a predictive parser. An algorithm for this purpose is given in Section 5.4. The following limited construction suffices for the present:

1. Construct a predictive parser, ignoring the actions in productions.
2. Copy the actions from the translation scheme into the parser. If an action appears after grammar symbol  $X$  in production  $p$ , then it is copied after the implementation of  $X$  in the code for  $p$ . Otherwise, if it appears at the beginning of the production, then it is copied just before the code for the production body.

We shall construct such a translator in Section 2.5.

### 2.4.5 Left Recursion

It is possible for a recursive-descent parser to loop forever. A problem arises with "left-recursive" productions like

$$expr \rightarrow y \quad expr + term$$

where the leftmost symbol of the body is the same as the nonterminal at the head of the production. Suppose the procedure for  $expr$  decides to apply this production. The body begins with  $expr$  so the procedure for  $expr$  is called recursively. Since the lookahead symbol changes only when a terminal in the body is matched, no change to the input took place between recursive calls of  $expr$ . As a result, the second call to  $expr$  does exactly what the first call did, which means a third call to  $expr$ , and so on, forever.

A left-recursive production can be eliminated by rewriting the offending production. Consider a nonterminal  $A$  with two productions

$$A \rightarrow \bullet Aa \mid /3$$

where  $a$  and  $/3$  are sequences of terminals and nonterminals that do not start with  $A$ . For example, in

$$expr \rightarrow y \quad expr + term \quad \mid \quad term$$

nonterminal  $A = expr$ , string  $a = + term$ , and string  $/3 = term$ .

The nonterminal  $A$  and its production are said to be *left recursive*, because the production  $A \rightarrow Aa$  has  $A$  itself as the leftmost symbol on the right side.<sup>4</sup> Repeated application of this production builds up a sequence of  $a$ 's to the right of  $A$ , as in Fig. 2.20(a). When  $A$  is finally replaced by  $/3$ , we have a  $/3$  followed by a sequence of zero or more  $a$ 's.

The same effect can be achieved, as in Fig. 2.20(b), by rewriting the productions for  $A$  in the following manner, using a new nonterminal  $R$ :

<sup>4</sup>In a general left-recursive grammar, instead of a production  $A \rightarrow Aa$ , the nonterminal  $A$  may derive  $Aa$  through intermediate productions.

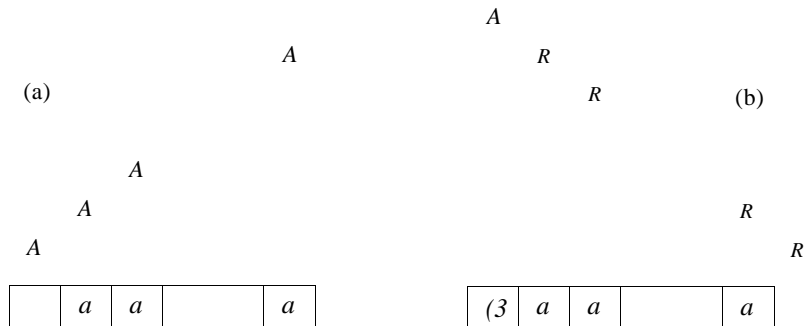

Figure 2.20: Left- and right-recursive ways of generating a string

$$\begin{aligned} A &\rightarrow \ /3R \\ R &\rightarrow \bullet aR \mid e \end{aligned}$$

Nonterminal  $R$  and its production  $R \rightarrow aR$  are *recursive* because this production for  $R$  has  $R$  itself as the last symbol on the right side. Right-recursive productions lead to trees that grow down towards the right, as in Fig. 2.20(b). Trees growing down to the right make it harder to translate expressions containing left-associative operators, such as minus. In Section 2.5.2, however, we shall see that the proper translation of expressions into postfix notation can still be attained by a careful design of the translation scheme.

In Section 4.3.3, we shall consider more general forms of left recursion and show how all left recursion can be eliminated from a grammar.

## 2.4.6 Exercises for Section 2.4

**Exercise 2.4.1:** Construct recursive-descent parsers, starting with the following grammars:

- a)  $S \rightarrow + SS \mid -SS \mid a$
- b)  $S \rightarrow 5 ( 5 ) 5 \mid e$
- c)  $S \rightarrow 0 5 1 \mid 0 1$

## 2.5 A Translator for Simple Expressions

Using the techniques of the last three sections, we now construct a syntax-directed translator, in the form of a working Java program, that translates arithmetic expressions into postfix form. To keep the initial program manageably small, we start with expressions consisting of digits separated by binary plus and minus signs. We extend the program in Section 2.6 to translate expressions that include numbers and other operators. It is worth studying the

translation of expressions in detail, since they appear as a construct in so many languages.

A syntax-directed translation scheme often serves as the specification for a translator. The scheme in Fig. 2.21 (repeated from Fig. 2.15) defines the translation to be performed here.

<i>expr</i>	->	<i>expr</i> + <i>term</i>	{ print('+') }
		/ <i>expr</i> - <i>term</i>	{ print('-') }
		/ <i>term</i>	
<i>term</i>	->	0	{ print('0') }
		1	{ print('1') }
		9	{ print('9') }

Figure 2.21: Actions for translating into postfix notation

Often, the underlying grammar of a given scheme has to be modified before it can be parsed with a predictive parser. In particular, the grammar underlying the scheme in Fig. 2.21 is left recursive, and as we saw in the last section, a predictive parser cannot handle a left-recursive grammar.

We appear to have a conflict: on the one hand we need a grammar that facilitates translation, on the other hand we need a significantly different grammar that facilitates parsing. The solution is to begin with the grammar for easy translation and carefully transform it to facilitate parsing. By eliminating the left recursion in Fig. 2.21, we can obtain a grammar suitable for use in a predictive recursive-descent translator.

### 2.5.1 Abstract and Concrete Syntax

A useful starting point for designing a translator is a data structure called an abstract syntax tree. In an *abstract syntax tree* for an expression, each interior node represents an operator; the children of the node represent the operands of the operator. More generally, any programming construct can be handled by making up an operator for the construct and treating as operands the semantically meaningful components of that construct.

In the abstract syntax tree for  $9-5+2$  in Fig. 2.22, the root represents the operator  $+$ . The subtrees of the root represent the subexpressions  $9-5$  and  $2$ . The grouping of  $9-5$  as an operand reflects the left-to-right evaluation of operators at the same precedence level. Since  $-$  and  $+$  have the same precedence,  $9-5+2$  is equivalent to  $(9-5)+2$ .

Abstract syntax trees, or simply *syntax trees*, resemble parse trees to an extent. However, in the syntax tree, interior nodes represent programming constructs while in the parse tree, the interior nodes represent nonterminals. Many nonterminals of a grammar represent programming constructs, but others

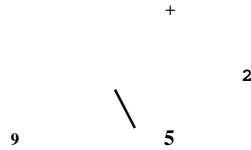

Figure 2.22: Syntax tree for 9-5+2

are "helpers" of one sort or another, such as those representing terms, factors, or other variations of expressions. In the syntax tree, these helpers typically are not needed and are hence dropped. To emphasize the contrast, a parse tree is sometimes called a *concrete syntax tree*, and the underlying grammar is called a *concrete syntax* for the language.

In the syntax tree in Fig. 2.22, each interior node is associated with an operator, with no "helper" nodes for *single productions* (a production whose body consists of a single nonterminal, and nothing else) like  $expr \rightarrow \bullet term$  or for e-productions like  $rest \rightarrow e$ .

It is desirable for a translation scheme to be based on a grammar whose parse trees are as close to syntax trees as possible. The grouping of subexpressions by the grammar in Fig. 2.21 is similar to their grouping in syntax trees. For example, subexpressions of the addition operator are given by  $expr$  and  $term$  in the production body  $expr + term$ .

## 2.5.2 Adapting the Translation Scheme

The left-recursion-elimination technique sketched in Fig. 2.20 can also be applied to productions containing semantic actions. First, the technique extends to multiple productions for  $A$ . In our example,  $A$  is  $expr$ , and there are two left-recursive productions for  $expr$  and one that is not left recursive. The technique transforms the productions  $A \rightarrow \bullet Aa \mid A\beta \mid \gamma$  into

$$\begin{array}{l} A \rightarrow \bullet \gamma.R \\ R \quad \quad \quad aR \backslash \beta R \backslash e \end{array}$$

Second, we need to transform productions that have embedded actions, not just terminals and nonterminals. Semantic actions embedded in the productions are simply carried along in the transformation, as if they were terminals.

**Example 2.13:** Consider the translation scheme of Fig. 2.21. Let

$$\begin{array}{l} A \quad \quad \quad expr \\ a \quad \quad \quad + \ term \ \{ \ print('+' ) \} \\ \quad \quad \quad - \ term \ \{ \ print('-' ) \} \\ 1 \quad \quad \quad term \end{array}$$

Then the left-recursion-eliminating transformation produces the translation scheme in Fig. 2.23. The *expr* productions in Fig. 2.21 have been transformed into the productions for *expr*, and a new nonterminal *rest* plays the role of *R*. The productions for *term* are repeated from Fig. 2.21. Figure 2.24 shows how  $9-5+2$  is translated using the grammar in Fig. 2.23. •

$$\begin{array}{l}
 \textit{expr} \rightarrow \textit{term rest} \\
 \textit{rest} \rightarrow + \textit{term} \{ \textit{print}('+' ) \} \textit{rest} \\
 \quad \quad | - \textit{term} \{ \textit{print}('-' ) \} \textit{rest} \\
 \quad \quad \mathbf{I} \\
 \quad \quad \textit{c} \\
 \textit{term} \rightarrow 0 \{ \textit{print}('0' ) \} \\
 \quad \quad | 1 \{ \textit{print}('1' ) \} \\
 \\
 \quad \quad | 9 \{ \textit{print}('9' ) \}
 \end{array}$$

Figure 2.23: Translation scheme after left-recursion elimination

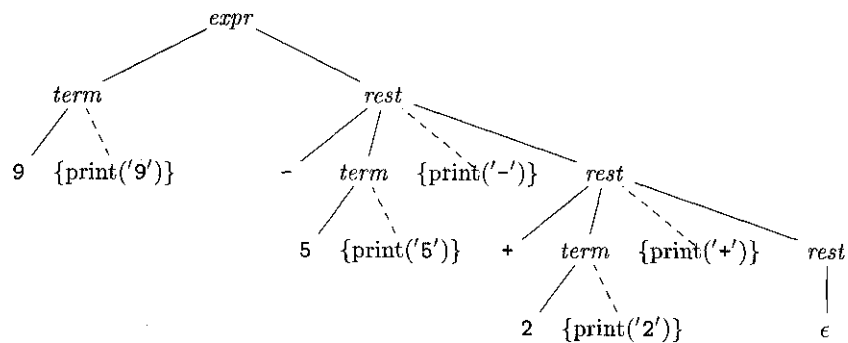

Figure 2.24: Translation of  $9-5+2$  to  $95-2+$

Left-recursion elimination must be done carefully, to ensure that we preserve the ordering of semantic actions. For example, the transformed scheme in Fig. 2.23 has the actions  $\{ \textit{print}('+' ) \}$  and  $\{ \textit{print}('-' ) \}$  in the middle of a production body, in each case between nonterminals *term* and *rest*. If the actions were to be moved to the end, after *rest*, then the translations would become incorrect. We leave it to the reader to show that  $9-5+2$  would then be translated incorrectly into  $952+-$ , the postfix notation for  $9-(5+2)$ , instead of the desired  $95-2+$ , the postfix notation for  $(9-5)+2$ .

### 2.5.3 Procedures for the Nonterminals

Functions *expr*, *rest*, and *term* in Fig. 2.25 implement the syntax-directed translation scheme in Fig. 2.23. These functions mimic the production bodies of the corresponding nonterminals. Function *expr* implements the production  $expr \rightarrow term\ rest$  by the calls *termQ* followed by *restQ*.

```

void exprQ {
    termi);  restQ;
}

void restQ {
    if ( lookahead == '+' ) {
        match('+');  termQ;  print('+');  restQ;
    }
    else if ( lookahead == '-' ) {
        match('');  termQ;  print('');  restQ;
    }
    else { } /* do nothing with the input */ ;
}

void termQ {
    if ( lookahead is a digit ) {
        t = lookahead;  match(lookahead);  print(t);
    }
    else report ("syntax error");
}

```

Figure 2.25: Pseudocode for nonterminals *expr*, *rest*, and *term*.

Function *rest* implements the three productions for nonterminal *rest* in Fig. 2.23. It applies the first production if the lookahead symbol is a plus sign, the second production if the lookahead symbol is a minus sign, and the production  $rest \rightarrow e$  in all other cases. The first two productions for *rest* are implemented by the first two branches of the if-statement in procedure *rest*. If the lookahead symbol is +, the plus sign is matched by the call *match*('+'). After the call *termQ*, the semantic action is implemented by writing a plus character. The second production is similar, with - instead of +. Since the third production for *rest* has *e* as its right side, the last else-clause in function *rest* does nothing.

The ten productions for *term* generate the ten digits. Since each of these productions generates a digit and prints it, the same code in Fig. 2.25 implements them all. If the test succeeds, variable *t* saves the digit represented by *lookahead* so it can be written after the call to *match*. Note that *match* changes

the lookahead symbol, so the digit needs to be saved for later printing.<sup>5</sup>

### 2.5.4 Simplifying the Translator

Before showing a complete program, we shall make two simplifying transformations to the code in Fig. 2.25. The simplifications will fold procedure *rest* into procedure *expr*. When expressions with multiple levels of precedence are translated, such simplifications reduce the number of procedures needed.

First, certain recursive calls can be replaced by iterations. When the last statement executed in a procedure body is a recursive call to the same procedure, the call is said to be *tail recursive*. For example, in function *rest*, the calls of *rest()* with lookahead + and - are tail recursive because in each of these branches, the recursive call to *rest* is the last statement executed by the given call of *rest*.

For a procedure without parameters, a tail-recursive call can be replaced simply by a jump to the beginning of the procedure. The code for *rest* can be rewritten as the pseudocode of Fig. 2.26. As long as the lookahead symbol is a plus or a minus sign, procedure *rest* matches the sign, calls *term* to match a digit, and continues the process. Otherwise, it breaks out of while loop and returns from *rest*.

```

void restQ {
    while( true ) {
        if( lookahead == '+' ) {
            match('+'); termQ; print('+'); continue;
        }
        else if ( lookahead == '-' ) {
            match('-'); termQ; print('-'); continue;
        }
        break ;
    }
}

```

Figure 2.26: Eliminating tail recursion in the procedure *rest* of Fig. 2.25.

Second, the complete Java program will include one more change. Once the tail-recursive calls to *rest* in Fig. 2.25 are replaced by iterations, the only remaining call to *rest* is from within procedure *expr*. The two procedures can therefore be integrated into one, by replacing the call *restQ* by the body of procedure *rest*.

<sup>5</sup> As a minor optimization, we could print before calling *match* to avoid the need to save the digit. In general, changing the order of actions and grammar symbols is risky, since it could change what the translation does.



### 2.5.5 The Complete Program

The complete Java program for our translator appears in Fig. 2.27. The first line of Fig. 2.27, beginning with `import`, provides access to the package `java.io` for system input and output. The rest of the code consists of the two classes `Parser` and `Postfix`. Class `Parser` contains variable `lookahead` and functions `Parser`, `expr`, `term`, and `match`.

Execution begins with function `main`, which is defined in class `Postfix`. Function `main` creates an instance `parse` of class `Parser` and calls its function `expr` to parse an expression.

The function `Parser`, with the same name as its class, is a *constructor*, it is called automatically when an object of the class is created. Notice from its definition at the beginning of class `Parser` that the constructor `Parser` initializes variable `lookahead` by reading a token. Tokens, consisting of single characters, are supplied by the system input routine `read`, which reads the next character from the input file. Note that `lookahead` is declared to be an integer, rather than a character, to anticipate the fact that additional tokens other than single characters will be introduced in later sections.

Function `expr` is the result of the simplifications discussed in Section 2.5.4; it implements nonterminals `expr` and `rest` in Fig. 2.23. The code for `expr` in Fig. 2.27 calls `term` and then has a while-loop that forever tests whether `lookahead` matches either '+' or '-'. Control exits from this while-loop when it reaches the return statement. Within the loop, the input/output facilities of the `System` class are used to write a character.

Function `term` uses the routine `isDigit` from the Java class `Character` to test if the lookahead symbol is a digit. The routine `isDigit` expects to be applied to a character; however, `lookahead` is declared to be an integer, anticipating future extensions. The construction `(char) lookahead` casts or coerces `lookahead` to be a character. In a small change from Fig. 2.25, the semantic action of writing the lookahead character occurs before the call to `match`.

The function `match` checks terminals; it reads the next input terminal if the lookahead symbol is matched and signals an error otherwise by executing

```
throw new Error("syntax error");
```

This code creates a new exception of class `Error` and supplies it the string `syntax error` as an error message. Java does not require `Error` exceptions to be declared in a `throws` clause, since they are meant to be used only for abnormal events that should never occur.<sup>6</sup>

<sup>6</sup>Error handling can be streamlined using the exception-handling facilities of Java. One approach is to define a new exception, say `SyntaxError`, that extends the system class `Exception`. Then, throw `SyntaxError` instead of `Error` when an error is detected in either `term` or `match`. Further, handle the exception in `main` by enclosing the call `parse.expr()` within a `try` statement that catches exception `SyntaxError`, writes a message, and terminates. We would need to add a class `SyntaxError` to the program in Fig. 2.27. To complete the extension, in addition to `IOException`, functions `match` and `term` must now declare that they can throw `SyntaxError`. Function `expr`, which calls them, must also declare that it can throw `SyntaxError`.

```
import java.io.*;
class Parser {
    static int lookahead;

    public Parser() throws IOException {
        lookahead = System.in.read();
    }

    void expr() throws IOException {
        term();
        while(true) {
            if( lookahead ==      ) {
                match('+');term();System.out.write('+' );
            }
            else if( lookahead == '-' ) {
                match('-'); term(); System.out.write('-');
            }
            else return;
        }
    }

    void term() throws IOException {
        if( Character.isDigit((char)lookahead) ) {
            System.out.write((char)lookahead); match(lookahead);
        }
        else throw new Error("syntax error");
    }

    void match(int t) throws IOException {
        if( lookahead == t ) lookahead = System.in.read();
        else throw new Error("syntax error");
    }
}
>

public class Postfix {
    public static void main(String[] args) throws IOException {
        Parser parse = new Parser();
        parse.expr(); System.out.write('\n');
    }
}
>
```

Figure 2.27: Java program to translate infix expressions into postfix form

## A Few Salient Features of Java

Those unfamiliar with Java may find the following notes on Java helpful in reading the code in Fig. 2.27:

- A class in Java consists of a sequence of variable and function definitions.
- Parentheses enclosing function parameter lists are needed even if there are no parameters; hence we write `expr()` and `term()`. These functions are actually procedures, because they do not return values, signified by the keyword `void` before the function name.
- Functions communicate either by passing parameters "by value" or by accessing shared data. For example, the functions `expr()` and `term()` examine the lookahead symbol using the class variable `lookahead` that they can all access since they all belong to the same class `Parser`.
- Like C, Java uses `=` for assignment, `==` for equality, and `!=` for inequality.
- The clause `"throws IOException"` in the definition of `term()` declares that an exception called `IOException` can occur. Such an exception occurs if there is no input to be read when the function `match` uses the routine `read`. Any function that calls `match` must also declare that an `IOException` can occur during its own execution.

## 2.6 Lexical Analysis

A lexical analyzer reads characters from the input and groups them into "token objects." Along with a terminal symbol that is used for parsing decisions, a token object carries additional information in the form of attribute values. So far, there has been no need to distinguish between the terms "token" and "terminal," since the parser ignores the attribute values that are carried by a token. In this section, a token is a terminal along with additional information.

A sequence of input characters that comprises a single token is called a *lexeme*. Thus, we can say that the lexical analyzer insulates a parser from the lexeme representation of tokens.

The lexical analyzer in this section allows numbers, identifiers, and "white space" (blanks, tabs, and newlines) to appear within expressions. It can be used to extend the expression translator of the previous section. Since the expression grammar of Fig. 2.21 must be extended to allow numbers and identifiers, we

shall take this opportunity to allow multiplication and division as well. The extended translation scheme appears in Fig. 2.28.

```

expr  ->  expr + term    { print('+') }
        |  expr - term    { print('-') }
        |  term
term  ->•  term * factor   { print('*') }
        |  term / factor   { print('/') }
        |  factor
factor ->  ( expr)
        |  num             { print(num.value) }
        |  id              { print(id.lexeme) }

```

Figure 2.28: Actions for translating into postfix notation

In Fig. 2.28, the terminal **num** is assumed to have an attribute *imm.value*, which gives the integer value corresponding to this occurrence of **num**. Terminal **id** has a string-valued attribute written as *id.lexeme*; we assume this string is the actual lexeme comprising this instance of the token **id**.

The pseudocode fragments used to illustrate the workings of a lexical analyzer will be assembled into Java code at the end of this section. The approach in this section is suitable for hand-written lexical analyzers. Section 3.5 describes a tool called Lex that generates a lexical analyzer from a specification. Symbol tables or data structures for holding information about identifiers are considered in Section 2.7.

### 2.6.1 Removal of White Space and Comments

The expression translator in Section 2.5 sees every character in the input, so extraneous characters, such as blanks, will cause it to fail. Most languages allow arbitrary amounts of white space to appear between tokens. Comments are likewise ignored during parsing, so they may also be treated as white space.

If white space is eliminated by the lexical analyzer, the parser will never have to consider it. The alternative of modifying the grammar to incorporate white space into the syntax is not nearly as easy to implement.

The pseudocode in Fig. 2.29 skips white space by reading input characters as long as it sees a blank, a tab, or a newline. Variable *peek* holds the next input character. Line numbers and context are useful within error messages to help pinpoint errors; the code uses variable *line* to count newline characters in the input.

```
for ( ; peek = next input character ) {  
    if ( peek is a blank or a tab ) do nothing;  
    else if ( peek is a newline ) line = line+1;  
    else break;  
}
```

Figure 2.29: Skipping white space

### 2.6.2 Reading Ahead

A lexical analyzer may need to read ahead some characters before it can decide on the token to be returned to the parser. For example, a lexical analyzer for C or Java must read ahead after it sees the character `>`. If the next character is `=`, then `>` is part of the character sequence `>=`, the lexeme for the token for the "greater than or equal to" operator. Otherwise `>` itself forms the "greater than" operator, and the lexical analyzer has read one character too many.

A general approach to reading ahead on the input, is to maintain an input buffer from which the lexical analyzer can read and push back characters. Input buffers can be justified on efficiency grounds alone, since fetching a block of characters is usually more efficient than fetching one character at a time. A pointer keeps track of the portion of the input that has been analyzed; pushing back a character is implemented by moving back the pointer. Techniques for input buffering are discussed in Section 3.2.

One-character read-ahead usually suffices, so a simple solution is to use a variable, say *peek*, to hold the next input character. The lexical analyzer in this section reads ahead one character while it collects digits for numbers or characters for identifiers; e.g., it reads past `1` to distinguish between `1` and `10`, and it reads past `t` to distinguish between `t` and `true`.

The lexical analyzer reads ahead only when it must. An operator like `*` can be identified without reading ahead. In such cases, *peek* is set to a blank, which will be skipped when the lexical analyzer is called to find the next token. The invariant assertion in this section is that when the lexical analyzer returns a token, variable *peek* either holds the character beyond the lexeme for the current token, or it holds a blank.

### 2.6.3 Constants

Anytime a single digit appears in a grammar for expressions, it seems reasonable to allow an arbitrary integer constant in its place. Integer constants can be allowed either by creating a terminal symbol, say **num**, for such constants or by incorporating the syntax of integer constants into the grammar. The job of collecting characters into integers and computing their collective numerical value is generally given to a lexical analyzer, so numbers can be treated as single units during parsing and translation.

When a sequence of digits appears in the input stream, the lexical analyzer passes to the parser a token consisting of the terminal **num** along with an integer-valued attribute computed from the digits. If we write tokens as tuples enclosed between ( ), the input **31 + 28 + 59** is transformed into the sequence

**(num, 31) (+) (num, 28) (+) (num, 59)**

Here, the terminal symbol + has no attributes, so its tuple is simply (+). The pseudocode in Fig. 2.30 reads the digits in an integer and accumulates the value of the integer using variable *v*.

```

if ( peek holds a digit ) {
    v = 0;
    do {
        v = v * 10 + integer value of digit peek;
        peek = next input character;
    } while ( peek holds a digit );
    return token ( num, v );
}

```

Figure 2.30: Grouping digits into integers

## 2.6.4 Recognizing Keywords and Identifiers

Most languages use fixed character strings such as **for**, **do**, and **if**, as punctuation marks or to identify constructs. Such character strings are called *keywords*.

Character strings are also used as identifiers to name variables, arrays, functions, and the like. Grammars routinely treat identifiers as terminals to simplify the parser, which can then expect the same terminal, say **id**, each time any identifier appears in the input. For example, on input

**count = count + increment;** (2.6)

the parser works with the terminal stream **id = id + id**. The token for **id** has an attribute that holds the lexeme. Writing tokens as tuples, we see that the tuples for the input stream (2.6) are

**(id, "count") (=) (id, "count") (+) (id, "increment") (;)**

Keywords generally satisfy the rules for forming identifiers, so a mechanism is needed for deciding when a lexeme forms a keyword and when it forms an identifier. The problem is easier to resolve if keywords are *reserved*; i.e., if they cannot be used as identifiers. Then, a character string forms an identifier only if it is not a keyword.

The lexical analyzer in this section solves two problems by using a table to hold character strings:

- *Single Representation.* A string table can insulate the rest of the compiler from the representation of strings, since the phases of the compiler can work with references or pointers to the string in the table. References can also be manipulated more efficiently than the strings themselves.
- *Reserved Words.* Reserved words can be implemented by initializing the string table with the reserved strings and their tokens. When the lexical analyzer reads a string or lexeme that could form an identifier, it first checks whether the lexeme is in the string table. If so, it returns the token from the table; otherwise, it returns a token with terminal **id**.

In Java, a string table can be implemented as a hash table using a class called *Hashtable*. The declaration

```
Hashtable words = new HashtableQ;
```

sets up *words* as a default hash table that maps keys to values. We shall use it to map lexemes to tokens. The pseudocode in Fig. 2.31 uses the operation *get* to look up reserved words.

```

if ( peek holds a letter ) {
    collect letters or digits into a buffer 6;
    s = string formed from the characters in 6;
    w = token returned by words.get(s);
    if ( w is not null ) return w;
    else {
        Enter the key-value pair (s, (id, s)) into words
        return token (id, s);
    }
}

```

Figure 2.31: Distinguishing keywords from identifiers

This pseudocode collects from the input a string *s* consisting of letters and digits beginning with a letter. We assume that *s* is made as long as possible; i.e., the lexical analyzer will continue reading from the input as long as it encounters letters and digits. When something other than a letter or digit, e.g., white space, is encountered, the lexeme is copied into a buffer 6. If the table has an entry for *s*, then the token retrieved by *words.get* is returned. Here, *s* could be either a keyword, with which the *words* table was initially seeded, or it could be an identifier that was previously entered into the table. Otherwise, token **id** and attribute *s* are installed in the table and returned.

### 2.6.5 A Lexical Analyzer

The pseudocode fragments so far in this section fit together to form a function *scan* that returns token objects, as follows:

```

Token scanQ {
    skip white space, as in Section 2.6.1;
    handle numbers, as in Section 2.6.3;
    handle reserved words and identifiers, as in Section 2.6.4;
    /* if we get here, treat read-ahead character peek as a token */
    Token t = new Token(peek);
    peek = blank /* initialization, as discussed in Section 2.6.2 */ ;
    return t;
}

```

The rest of this section implements function *scan* as part of a Java package for lexical analysis. The package, called *lexer* has classes for tokens and a class *Lexer* containing function *scan*.

The classes for tokens and their fields are illustrated in Fig. 2.32; their methods are not shown. Class *Token* has a field *tag* that is used for parsing decisions. Subclass *Num* adds a field *value* for an integer value. Subclass *Word* adds a field *lexeme* that is used for reserved words and identifiers.

```

class Token
    int tag

class Num
    int value

class Word
    string lexeme

```

Figure 2.32: Class *Token* and subclasses *Num* and *Word*

Each class is in a file by itself. The file for class *Token* is as follows:

```

1) package lexer; // File Token.java
2) public class Token {
3)     public final int tag;
4)     public Token(int t) { tag = t; }
5) >

```

Line 1 identifies the package *lexer*. Field *tag* is declared on line 3 to be *final* so it cannot be changed once it is set. The constructor *Token* on line 4 is used to create token objects, as in

```
new Token('+')
```

which creates a new object of class *Token* and sets its field *tag* to an integer representation of '+'. (For brevity, we omit the customary method *toString*, which would return a string suitable for printing.)



Where the pseudocode had terminals like `num` and `id`, the Java code uses integer constants. Class `Tag` implements such constants:

```

1) package lexer;                               // File Tag.java
2) public class Tag {
3)     public final static int
4)         NUM = 256, ID = 257, TRUE = 258, FALSE = 259;
5) >

```

In addition to the integer-valued fields `NUM` and `ID`, this class defines two additional fields, `TRUE` and `FALSE`, for future use; they will be used to illustrate the treatment of reserved keywords.<sup>7</sup>

The fields in class `Tag` are public, so they can be used outside the package. They are static, so there is just one instance or copy of these fields. The fields are final, so they can be set just once. In effect, these fields represent constants. A similar effect is achieved in C by using define-statements to allow names such as `NUM` to be used as symbolic constants, e.g.:

```
#define NUM 256
```

The Java code refers to `Tag.NUM` and `Tag.ID` in places where the pseudocode referred to terminals `num` and `id`. The only requirement is that `Tag.NUM` and `Tag.ID` must be initialized with distinct values that differ from each other and from the constants representing single-character tokens, such as `'+'` or `'*'`.

```

1) package lexer;                               // File Num.java
2) public class Num extends Token {
3)     public final int value;
4)     public Num(int v) { super(Tag.NUM); value = v; }
5) >
1) package lexer;                               // File Word.java
2) public class Word extends Token {
3)     public final String lexeme;
4)     public WordQnt t, String s) {
5)         super(t); lexeme = new String(s);
6)     }
7) >

```

Figure 2.33: Subclasses `Num` and `Word` of `Token`

Classes `Num` and `Word` appear in Fig. 2.33. Class `Num` extends `Token` by declaring an integer field `value` on line 3. The constructor `Num` on line 4 calls `super(Tag.NUM)`, which sets field `tag` in the superclass `Token` to `Tag.NUM`.

<sup>7</sup>ASCII characters are typically converted into integers between 0 and 255. We therefore use integers greater than 255 for terminals.

```

1) package lexer;                               // File Lexer.java
2) import java.io.*; import java.util.*;
3) public class Lexer {
4)     public int line = 1;
5)     private char peek = ' ';
6)     private Hashtable words = new Hashtable0;
7)     void reserve(Word t) { words.put(t.lexeme, t); }
8)     public Lexer() {
9)         reserve( new Word(Tag.TRUE, "true") );
10)        reserve( new Word(Tag.FALSE, "false") );
11)    }
12)    public Token scan() throws IOException {
13)        for( ; ; peek = (char)System.in.read() ) {
14)            if( peek == ' ' || peek == '\t' ) continue;
15)            else if( peek == '\n' ) line = line + 1;
16)            else break;
17)        }
    /* continues in Fig. 2.35 */

```

Figure 2.34: Code for a lexical analyzer, part 1 of 2

Class **Word** is used for both reserved words and identifiers, so the constructor **Word** on line 4 expects two parameters: a lexeme and a corresponding integer value for **tag**. An object for the reserved word **true** can be created by executing

```
new Word(Tag.TRUE, "true")
```

which creates a new object with field **tag** set to **Tag.TRUE** and field **lexeme** set to the string **"true"**.

Class **Lexer** for lexical analysis appears in Figs. 2.34 and 2.35. The integer variable **line** on line 4 counts input lines, and character variable **peek** on line 5 holds the next input character.

Reserved words are handled on lines 6 through 11. The table **words** is declared on line 6. The helper function **reserve** on line 7 puts a string-word pair in the table. Lines 9 and 10 in the constructor **Lexer** initialize the table. They use the constructor **Word** to create word objects, which are passed to the helper function **reserve**. The table is therefore initialized with reserved words **"true"** and **"false"** before the first call of **scan**.

The code for **scan** in Fig. 2.34-2.35 implements the pseudocode fragments in this section. The for-statement on lines 13 through 17 skips blank, tab, and newline characters. Control leaves the for-statement with **peek** holding a non-white-space character.

The code for reading a sequence of digits is on lines 18 through 25. The function **isDigit** is from the built-in Java class **Character**. It is used on line 18 to check whether **peek** is a digit. If so, the code on lines 19 through 24

```

18)     if( Character.isDigit(peek) ) {
19)         int v = 0;
20)         do {
21)             v = 10*v + Character.digit(peek, 10);
22)             peek = (char)System.in.read();
23)         } while( Character.isDigit(peek) );
24)         return new Num(v);
25)     }
26)     if( Character.isLetter(peek) ) {
27)         StringBuffer b = new StringBuffer();
28)         do {
29)             b.append(peek);
30)             peek = (char)System.in.read();
31)         } while( Character.isLetterOrDigit(peek) );
32)         String s = b.toString();
33)         Word w = (Word)words.get(s);
34)         if( w != null ) return w;
35)         w = new Word(Tag.ID, s);
36)         words.put(s, w);
37)         return w;
38)     }
39)     Token t = new Token(peek);
40)     peek = ' ';
41)     return t;
42) }
43) }

```

Figure 2.35: Code for a lexical analyzer, part 2 of 2

accumulates the integer value of the sequence of digits in the input and returns a new `Num` object.

Lines 26 through 38 analyze reserved words and identifiers. Keywords `true` and `false` have already been reserved on lines 9 and 10. Therefore, line 35 is reached if string `s` is not reserved, so it must be the lexeme for an identifier. Line 35 therefore returns a new word object with `lexeme` set to `s` and `tag` set to `Tag.ID`. Finally, lines 39 through 41 return the current character as a token and set `peek` to a blank that will be stripped the next time `scan` is called.

## 2.6.6 Exercises for Section 2.6

**Exercise 2.6.1:** Extend the lexical analyzer in Section 2.6.5 to remove comments, defined as follows:

- a) A comment begins with `//` and includes all characters until the end of that line.
- b) A comment begins with `/*` and includes all characters through the next occurrence of the character sequence `*/`.

Exercise 2.6.2: Extend the lexical analyzer in Section 2.6.5 to recognize the relational operators `<`, `<=`, `==`, `!=`, `>=`, `>`.

Exercise 2.6.3: Extend the lexical analyzer in Section 2.6.5 to recognize floating point numbers such as `2.`, `3.14`, and `.5`.

## 2.7 Symbol Tables

*Symbol tables* are data structures that are used by compilers to hold information about source-program constructs. The information is collected incrementally by the analysis phases of a compiler and used by the synthesis phases to generate the target code. Entries in the symbol table contain information about an identifier such as its character string (or lexeme), its type, its position in storage, and any other relevant information. Symbol tables typically need to support multiple declarations of the same identifier within a program.

From Section 1.6.1, the scope of a declaration is the portion of a program to which the declaration applies. We shall implement scopes by setting up a separate symbol table for each scope. A program block with declarations<sup>\*</sup> will have its own symbol table with an entry for each declaration in the block. This approach also works for other constructs that set up scopes; for example, a class would have its own table, with an entry for each field and method.

This section contains a symbol-table module suitable for use with the Java translator fragments in this chapter. The module will be used as is when we put together the translator in Appendix A. Meanwhile, for simplicity, the main example of this section is a stripped-down language with just the key constructs that touch symbol tables; namely, blocks, declarations, and factors. All of the other statement and expression constructs are omitted so we can focus on the symbol-table operations. A program consists of blocks with optional declarations and "statements" consisting of single identifiers. Each such statement represents a use of the identifier. Here is a sample program in this language:

```
{ int x; char y; { bool y; x; y; } x; y; }      (2.7)
```

The examples of block structure in Section 1.6.3 dealt with the definitions and uses of names; the input (2.7) consists solely of definitions and uses of names.

The task we shall perform is to print a revised program, in which the declarations have been removed and each "statement" has its identifier followed by a colon and its type.

<sup>\*</sup>In C, for instance, program blocks are either functions or sections of functions that are separated by curly braces and that have one or more declarations within them.

## Who Creates Symbol-Table Entries?

Symbol-table entries are created and used during the analysis phase by the lexical analyzer, the parser, and the semantic analyzer. In this chapter, we have the parser create entries. With its knowledge of the syntactic structure of a program, a parser is often in a better position than the lexical analyzer to distinguish among different declarations of an identifier.

In some cases, a lexical analyzer can create a symbol-table entry as soon as it sees the characters that make up a lexeme. More often, the lexical analyzer can only return to the parser a token, say **id**, along with a pointer to the lexeme. Only the parser, however, can decide whether to use a previously created symbol-table entry or create a new one for the identifier.

**Example 2.14:** On the above input (2.7), the goal is to produce:

```
{ { x:int; yrbool; } x:int; y:char; }
```

The first *x* and *y* are from the inner block of input (2.7). Since this use of *x* refers to the declaration of *x* in the outer block, it is followed by `int`, the type of that declaration. The use of *y* in the inner block refers to the declaration of *y* in that very block and therefore has boolean type. We also see the uses of *x* and *y* in the outer block, with their types, as given by declarations of the outer block: integer and character, respectively. •

### 2.7.1 Symbol Table Per Scope

The term "scope of identifier" really refers to the scope of a particular declaration of *x*. The term *scope* by itself refers to a portion of a program that is the scope of one or more declarations.

Scopes are important, because the same identifier can be declared for different purposes in different parts of a program. Common names like *i* and *x* often have multiple uses. As another example, subclasses can redeclare a method name to override a method in a superclass.

If blocks can be nested, several declarations of the same identifier can appear within a single block. The following syntax results in nested blocks when *stmts* can generate a block:

```
block -> '{ decls stmts }'
```

(We quote curly braces in the syntax to distinguish them from curly braces for semantic actions.) With the grammar in Fig. 2.38, *decls* generates an optional sequence of declarations and *stmts* generates an optional sequence of statements.

## Optimization of Symbol Tables for Blocks

Implementations of symbol tables for blocks can take advantage of the most-closely nested rule. Nesting ensures that the chain of applicable symbol tables forms a stack. At the top of the stack is the table for the current block. Below it in the stack are the tables for the enclosing blocks. Thus, symbol tables can be allocated and deallocated in a stack-like fashion.

Some compilers maintain a single hash table of accessible entries; that is, of entries that are not hidden by a declaration in a nested block. Such a hash table supports essentially constant-time lookups, at the expense of inserting and deleting entries on block entry and exit. Upon exit from a block  $B$ , the compiler must undo any changes to the hash table due to declarations in block  $B$ . It can do so by using an auxiliary stack to keep track of changes to the hash table while block  $B$  is processed.

Moreover, a statement can be a block, so our language allows nested blocks, where an identifier can be redeclared.

The *most-closely nested* rule for blocks is that an identifier  $x$  is in the scope of the most-closely nested declaration of  $x$ ; that is, the declaration of  $x$  found by examining blocks inside-out, starting with the block in which  $x$  appears.

**Example 2.15:** The following pseudocode uses subscripts to distinguish among distinct declarations of the same identifier:

```

1) {   int xi; int y;
2)   {   int w2; bool y2; int z2;
3)       ... w2; ... xi2           y2           z2   ...;
4)   }
5)       ... w0; ... xi           ... yi ...;
6) }
```

The subscript is not part of an identifier; it is in fact the line number of the declaration that applies to the identifier. Thus, all occurrences of  $x$  are within the scope of the declaration on line 1. The occurrence of  $y$  on line 3 is in the scope of the declaration of  $y$  on line 2 since  $y$  is redeclared within the inner block. The occurrence of  $y$  on line 5, however, is within the scope of the declaration of  $y$  on line 1.

The occurrence of  $w$  on line 5 is presumably within the scope of a declaration of  $w$  outside this program fragment; its subscript 0 denotes a declaration that is global or external to this block.

Finally,  $z$  is declared and used within the nested block, but cannot be used on line 5, since the nested declaration applies only to the nested block. •

The most-closely nested rule for blocks can be implemented by chaining symbol tables. That is, the table for a nested block points to the table for its enclosing block.

**Example 2.16:** Figure 2.36 shows symbol tables for the pseudocode in Example 2.15.  $B_1$  is for the block starting on line 1 and  $B_2$  is for the block starting at line 2. At the top of the figure is an additional symbol table  $B_0$  for any global or default declarations provided by the language. During the time that we are analyzing lines 2 through 4, the environment is represented by a reference to the lowest symbol table — the one for  $B_0$ . When we move to line 5, the symbol table for  $B_1$  becomes inaccessible, and the environment refers instead to the symbol table for  $B_2$ , from which we can reach the global symbol table, but not the table for  $B_1$ . •

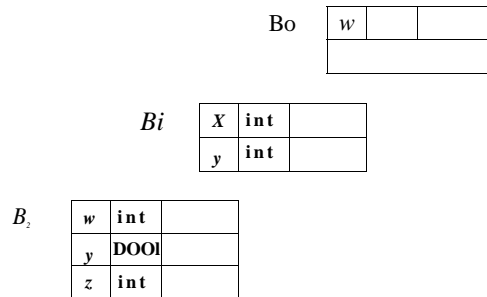

Figure 2.36: Chained symbol tables for Example 2.15

The Java implementation of chained symbol tables in Fig. 2.37 defines a class `Env`, short for *environment*.<sup>9</sup> Class `Env` supports three operations:

- *Create a new symbol table.* The constructor `Env(p)` on lines 6 through 8 of Fig. 2.37 creates an `Env` object with a hash table named `table`. The object is chained to the environment-valued parameter `p` by setting field `next` to `p`. Although it is the `Env` objects that form a chain, it is convenient to talk of the tables being chained.
- *Put a new entry in the current table.* The hash table holds key-value pairs, where:
  - The *key* is a string, or rather a reference to a string. We could alternatively use references to token objects for identifiers as keys.
  - The *value* is an entry of class `Symbol`. The code on lines 9 through 11 does not need to know the structure of an entry; that is, the code is independent of the fields and methods in class `Symbol`.

<sup>9</sup>"Environment" is another term for the collection of symbol tables that are relevant at a point in the program.

```

1) package symbols;                               // File Env.java
2) import java.util.*;
3) public class Env {
4)     private Hashtable table;
5)     protected Env prev;

6)     public Env(Env p) {
7)         table = new HashtableO; prev = p;
8)     } >
9)     public void put(String s, Symbol sym) {
10)        table.put(s, sym);
11)    } >
12)    public Symbol get(String s) {
13)        for( Env e = this; e != null; e = e.prev ) {
14)            Symbol found = (Symbol)(e.table.get(s));
15)            if( found != null ) return found;
16)        }
17)        return null;
18)    } }
19) }

```

Figure 2.37: Class *Env* implements chained symbol tables

- *Get* an entry for an identifier by searching the chain of tables, starting with the table for the current block. The code for this operation on lines 12 through 18 returns either a symbol-table entry or null.

Chaining of symbol tables results in a tree structure, since more than one block can be nested inside an enclosing block. The dotted lines in Fig. 2.36 are a reminder that chained symbol tables can form a tree.

### 2.7.2 The Use of Symbol Tables

In effect, the role of a symbol table is to pass information from declarations to uses. A semantic action "puts" information about identifier  $x$  into the symbol table, when the declaration of  $x$  is analyzed. Subsequently, a semantic action associated with a production such as  $factor \rightarrow id$  "gets" information about the identifier from the symbol table. Since the translation of an expression  $E_i \text{ op } E_j$ , for a typical operator **op**, depends only on the translations of  $E_i$  and  $E_j$ , and does not directly depend on the symbol table, we can add any number of operators without changing the basic flow of information from declarations to uses, through the symbol table.

**Example 2.17:** The translation scheme in Fig. 2.38 illustrates how class *Env* can be used. The translation scheme concentrates on scopes, declarations, and



uses. It implements the translation described in Example 2.14. As noted earlier, on input

```

program  ->•          { top = null; }
           block

block    ->           { saved = top;
                       top = new Env(top);
                       print("{ "); }
           decls stmts '}' { top = saved;
                           printO'} "; }

decls   ->  decls decl
           I  e

decl    ->•  type id ;   { s = new Symbol;
                           s.type = type, lexeme
                           top.put(id.lexeme, s); }

stmts   ->  stmts stmt

stmt    ->•  6/ocA;
           /  factor ;   { print("; "); }

factor  ->  id          { ' — top.get(id.lexeme);
                           print(id.lexeme);
                           print(":"); }
                           print (s.type);

```

Figure 2.38: The use of symbol tables for translating a language with blocks

```
{ int x; char y; { bool y; x; y; } x; y; }
```

the translation scheme strips the declarations and produces

```
{ { x:int; y:bool; } x:int; y:char; }
```

Notice that the bodies of the productions have been aligned in Fig. 2.38 so that all the grammar symbols appear in one column, and all the actions in a second column. As a result, components of the body are often spread over several lines.

Now, consider the semantic actions. The translation scheme creates and discards symbol tables upon block entry and exit, respectively. Variable *top* denotes the top table, at the head of a chain of tables. The first production of

the underlying grammar is  $program \rightarrow \bullet block$ . The semantic action before  $block$  initializes  $top$  to **null**, with no entries.

The second production,  $block \rightarrow \{ ' decls stmts' \}$ , has actions upon block entry and exit. On block entry, before  $decls$ , a semantic action saves a reference to the current table using a local variable  $saved$ . Each use of this production has its own local variable  $saved$ , distinct from the local variable for any other use of this production. In a recursive-descent parser,  $saved$  would be local to the procedure for  $block$ . The treatment of local variables of a recursive function is discussed in Section 7.2. The code

```
 $top = \mathbf{new} Env(top);$ 
```

sets variable  $top$  to a newly created new table that is chained to the previous value of  $top$  just before block entry. Variable  $top$  is an object of class  $Env$ ; the code for the constructor  $Env$  appears in Fig. 2.37.

On block exit, after  $\}$ , a semantic action restores  $top$  to its value saved on block entry. In effect, the tables form a stack; restoring  $top$  to its saved value pops the effect of the declarations in the block.<sup>10</sup> Thus, the declarations in the block are not visible outside the block.

A declaration,  $decls \rightarrow \mathbf{type} \mathbf{id}$  results in a new entry for the declared identifier. We assume that tokens **type** and **id** each have an associated attribute, which is the type and lexeme, respectively, of the declared identifier. We shall not go into all the fields of a symbol object  $s$ , but we assume that there is a field  $type$  that gives the type of the symbol. We create a new symbol object  $s$  and assign its type properly by  $s.type = \mathbf{type}.lexeme$ . The complete entry is put into the top symbol table by  $top.put(d.lexeme, s)$ .

The semantic action in the production  $factor \rightarrow \mathbf{id}$  uses the symbol table to get the entry for the identifier. The  $get$  operation searches for the first entry in the chain of tables, starting with  $top$ . The retrieved entry contains any information needed about the identifier, such as the type of the identifier. •

## 2.8 Intermediate Code Generation

The front end of a compiler constructs an intermediate representation of the source program from which the back end generates the target program. In this section, we consider intermediate representations for expressions and statements, and give tutorial examples of how to produce such representations.

### 2.8.1 Two Kinds of Intermediate Representations

As was suggested in Section 2.1 and especially Fig. 2.4, the two most important intermediate representations are:

<sup>10</sup>Instead of explicitly saving and restoring tables, we could alternatively add static operations  $push$  and  $pop$  to class  $Env$ .

- Trees, including parse trees and (abstract) syntax trees.
- Linear representations, especially "three-address code."

Abstract-syntax trees, or simply syntax trees, were introduced in Section 2.5.1, and in Section 5.3.1 they will be reexamined more formally. During parsing, syntax-tree nodes are created to represent significant programming constructs. As analysis proceeds, information is added to the nodes in the form of attributes associated with the nodes. The choice of attributes depends on the translation to be performed.

Three-address code, on the other hand, is a sequence of elementary program steps, such as the addition of two values. Unlike the tree, there is no hierarchical structure. As we shall see in Chapter 9, we need this representation if we are to do any significant optimization of code. In that case, we break the long sequence of three-address statements that form a program into "basic blocks," which are sequences of statements that are always executed one-after-the-other, with no branching.

In addition to creating an intermediate representation, a compiler front end checks that the source program follows the syntactic and semantic rules of the source language. This checking is called *static checking*; in general "static" means "done by the compiler."<sup>1</sup> Static checking assures that certain kinds of programming errors, including type mismatches, are detected and reported during compilation.

It is possible that a compiler will construct a syntax tree at the same time it emits steps of three-address code. However, it is common for compilers to emit the three-address code while the parser "goes through the motions" of constructing a syntax tree, without actually constructing the complete tree data structure. Rather, the compiler stores nodes and their attributes needed for semantic checking or other purposes, along with the data structure used for parsing. By so doing, those parts of the syntax tree that are needed to construct the three-address code are available when needed, but disappear when no longer needed. We take up the details of this process in Chapter 5.

## 2.8.2 Construction of Syntax Trees

We shall first give a translation scheme that constructs syntax trees, and later, in Section 2.8.4, show how the scheme can be modified to emit three-address code, along with, or instead of, the syntax tree.

Recall from Section 2.5.1 that the syntax tree

<sup>1</sup>Its opposite, "dynamic," means "while the program is running." Many languages also make certain dynamic checks. For instance, an object-oriented language like Java sometimes must check types during program execution, since the method applied to an object may depend on the particular subclass of the object.

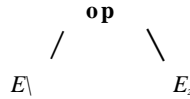

represents an expression formed by applying the operator **op** to the subexpressions represented by  $E_1$  and  $E_2$ . Syntax trees can be created for any construct, not just expressions. Each construct is represented by a node, with children for the semantically meaningful components of the construct. For example, the semantically meaningful components of a C while-statement:

**while** ( *expr* ) *stmt*

are the expression *expr* and the statement *stmt*.<sup>12</sup> The syntax-tree node for such a while-statement has an operator, which we call **while**, and two children—the syntax trees for the *expr* and the *stmt*.

The translation scheme in Fig. 2.39 constructs syntax trees for a representative, but very limited, language of expressions and statements. All the nonterminals in the translation scheme have an attribute *n*, which is a node of the syntax tree. Nodes are implemented as objects of class *Node*.

Class *Node* has two immediate subclasses: *Expr* for all kinds of expressions, and *Stmt* for all kinds of statements. Each type of statement has a corresponding subclass of *Stmt*; for example, operator **while** corresponds to subclass *While*. A syntax-tree node for operator **while** with children *x* and *y* is created by the pseudocode

**new** *While* (*x*,*y*)

which creates an object of class *While* by calling constructor function *While*, with the same name as the class. Just as constructors correspond to operators, constructor parameters correspond to operands in the abstract syntax.

When we study the detailed code in Appendix A, we shall see how methods are placed where they belong in this hierarchy of classes. In this section, we shall discuss only a few of the methods, informally.

We shall consider each of the productions and rules of Fig. 2.39, in turn. First, the productions defining different types of statements are explained, followed by the productions that define our limited types of expressions.

### Syntax Trees for Statements

For each statement construct, we define an operator in the abstract syntax. For constructs that begin with a keyword, we shall use the keyword for the operator. Thus, there is an operator **while** for while-statements and an operator **do** for do-while statements. Conditionals can be handled by defining two operators

<sup>12</sup>The right parenthesis serves only to separate the expression from the statement. The left parenthesis actually has no meaning; it is there only to please the eye, since without it, C would allow unbalanced parentheses.

```

program -> block          return block.n; }

block -> '{' stmts '}'    block.n = stmts.n; }

stmts -> stmtsi stmt      stmts.n = new Seq(stmtsi.n, stmt.n) }
      |  $\epsilon$           stmts.n = null; }

stmt -> expr ;           stmt.n = new Eval(expr.n); }
      | if ( expr ) stmti
                          stmt.n = new If(expr.n,stmti.n); }
      | while ( expr ) stmti
                          stmt.n = new While (expr.n, stmti.n); }
      | do stmt while ( expr );
                          stmt.n = new Do (stmti.n, expr.n); }
      | block             stmt.n = block.n; }

expr -> rel - expr,      expr.n = new Assign ('=', re/.n, errpr^.n); }
      | rel              expr.n = rein; }

rel -> rel < a         rein = new Rel('<', reli.n, add.n); }
      | rek <=         rein = new Rel('<=', reli.n, add.n); }
                          rel.n = add.n; }

add -> ftrfrfi + ierw   add.n = new Op('+', addi.n, term.n); }
      | term            .n = term.n; }

term -> iermi * factor  term.n = new Op('*',termi.n,factor.n); }
      | factor          term.n = factor.n; }

factor ( ezpr )        factor.n = expr.n; }
      num              factor.n = new Num (num.value); }

```

Figure 2.39: Construction of syntax trees for expressions and statements

**ifelse** and **if** for if-statements with and without an else part, respectively. In our simple example language, we do not use **else**, and so have only an if-statement. Adding **else** presents some parsing issues, which we discuss in Section 4.8.2.

Each statement operator has a corresponding class of the same name, with a capital first letter; e.g., class *If* corresponds to **if**. In addition, we define the subclass *Seq*, which represents a sequence of statements. This subclass corresponds to the nonterminal *stmts* of the grammar. Each of these classes are subclasses of *Stmt*, which in turn is a subclass of *Node*.

The translation scheme in Fig. 2.39 illustrates the construction of syntax-tree nodes. A typical rule is the one for if-statements:

$$stmt \rightarrow \text{if} ( expr ) stmti \quad \{ stmt.n = \text{new } If(expr.n, stmt\backslash.n); \}$$

The meaningful components of the if-statement are *expr* and *stmt\*. The semantic action defines the node *stmt.n* as a new object of subclass *If*. The code for the constructor // is not shown. It creates a new node labeled **if** with the nodes *expr.n* and *stmt\*.n as children.

Expression statements do not begin with a keyword, so we define a new operator **eval** and class *Eval*, which is a subclass of *Stmt*, to represent expressions that are statements. The relevant rule is:

$$stmt \rightarrow expr ; \quad \{ stmt.n = \text{new } Eval(expr.n); \}$$

### Representing Blocks in Syntax Trees

The remaining statement construct in Fig. 2.39 is the block, consisting of a sequence of statements. Consider the rules:

$$\begin{aligned} stmt &\rightarrow block && \{ stmt.n = block.n; \} \\ block &\rightarrow \{ ' stmts ' \} && \{ block.n = stmts.n; \} \end{aligned}$$

The first says that when a statement is a block, it has the same syntax tree as the block. The second rule says that the syntax tree for nonterminal *block* is simply the syntax tree for the sequence of statements in the block.

For simplicity, the language in Fig. 2.39 does not include declarations. Even when declarations are included in Appendix A, we shall see that the syntax tree for a block is still the syntax tree for the statements in the block. Since information from declarations is incorporated into the symbol table, they are not needed in the syntax tree. Blocks, with or without declarations, therefore appear to be just another statement construct in intermediate code.

A sequence of statements is represented by using a leaf **null** for an empty statement and an operator **seq** for a sequence of statements, as in

$$stmts \rightarrow * \cdot \quad stmtsi \quad stmt \quad \{ stmts.n = \text{new } Seq(stmts.n, stmt.n); \}$$

**Example 2.18:** In Fig. 2.40 we see part of a syntax tree representing a block or statement list. There are two statements in the list, the first an if-statement and the second a while-statement. We do not show the portion of the tree above this statement list, and we show only as a triangle each of the necessary subtrees: two expression trees for the conditions of the if- and while-statements, and two statement trees for their substatements. •

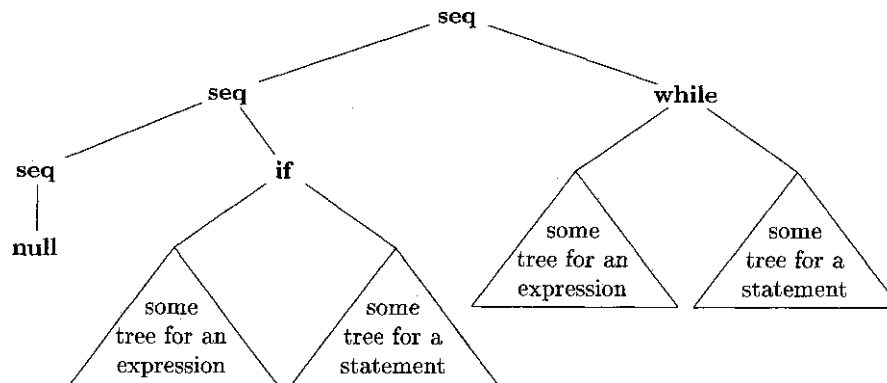

Figure 2.40: Part of a syntax tree for a statement list consisting of an if-statement and a while-statement

### Syntax Trees for Expressions

Previously, we handled the higher precedence of  $*$  over  $+$  by using three nonterminals *expr*, *term*, and *factor*. The number of nonterminals is precisely one plus the number of levels of precedence in expressions, as we suggested in Section 2.2.6. In Fig. 2.39, we have two comparison operators,  $<$  and  $<=$  at one precedence level, as well as the usual  $+$  and  $*$  operators, so we have added one additional nonterminal, called *add*.

Abstract syntax allows us to group "similar" operators to reduce the number of cases and subclasses of nodes in an implementation of expressions. In this chapter, we take "similar" to mean that the type-checking and code-generation rules for the operators are similar. For example, typically the operators  $+$  and  $*$  can be grouped, since they can be handled in the same way — their requirements regarding the types of operands are the same, and they each result in a single three-address instruction that applies one operator to two values. In general, the grouping of operators in the abstract syntax is based on the needs of the later phases of the compiler. The table in Fig. 2.41 specifies the correspondence between the concrete and abstract syntax for several of the operators of Java.

In the concrete syntax, all operators are left associative, except the assignment operator  $=$ , which is right associative. The operators on a line have the

CONCRETE SYNTAX	ABSTRACT SYNTAX
=	<b>assign</b>
<b>if</b>	<b>cond</b>
<b>&amp;&amp;</b>	<b>cond</b>
== !=	<b>rel</b>
<= >= >	<b>rel</b>
+ -	<b>op</b>
* / %	<b>op</b>
<b>j</b>	<b>not</b>
~ <i>unary</i>	<b>minus</b>
[]	<b>access</b>

Figure 2.41: Concrete and abstract syntax for several Java operators

same precedence; that is, == and != have the same precedence. The lines are in order of increasing precedence; e.g., == has higher precedence than the operators && and =. The subscript *unary* in *- unary* is solely to distinguish a leading unary minus sign, as in -2, from a binary minus sign, as in 2-a. The operator [] represents array access, as in a[i].

The abstract-syntax column specifies the grouping of operators. The assignment operator = is in a group by itself. The group **cond** contains the conditional boolean operators && and **if**. The group **rel** contains the relational comparison operators on the lines for == and <. The group **op** contains the arithmetic operators like + and \*. Unary minus, boolean negation, and array access are in groups by themselves.

The mapping between concrete and abstract syntax in Fig. 2.41 can be implemented by writing a translation scheme. The productions for nonterminals *expr*, *rel*, *add*, *term*, and *factor* in Fig. 2.39 specify the concrete syntax for a representative subset of the operators in Fig. 2.41. The semantic actions in these productions create syntax-tree nodes. For example, the rule

$$term \rightarrow term_i * factor \quad \{ term.n = \mathbf{new} \mathbf{Op}(V, term.n, factor.n); \}$$

creates a node of class *Op*, which implements the operators grouped under **op** in Fig. 2.41. The constructor *Op* has a parameter '\*' to identify the actual operator, in addition to the nodes *term<sub>n</sub>* and *factor<sub>n</sub>* for the subexpressions.

### 2.8.3 Static Checking

Static checks are consistency checks that are done during compilation. Not only do they assure that a program can be compiled successfully, but they also have the potential for catching programming errors early, before a program is run. Static checking includes:

- *Syntactic Checking.* There is more to syntax than grammars. For example, constraints such as an identifier being declared at most once in a



scope, or that a break statement must have an enclosing loop or switch statement, are syntactic, although they are not encoded in, or enforced by, a grammar used for parsing.

- *Type Checking.* The type rules of a language assure that an operator or function is applied to the right number and type of operands. If conversion between types is necessary, e.g., when an integer is added to a float, then the type-checker can insert an operator into the syntax tree to represent that conversion. We discuss type conversion, using the common term "coercion," below.

### L-values and R-values

We now consider some simple static checks that can be done during the construction of a syntax tree for a source program. In general, complex static checks may need to be done by first constructing an intermediate representation and then analyzing it.

There is a distinction between the meaning of identifiers on the left and right sides of an assignment. In each of the assignments

$$\begin{aligned} i &= 5; \\ i &= i + 1; \end{aligned}$$

the right side specifies an integer value, while the left side specifies where the value is to be stored. The terms *l-value* and *r-value* refer to values that are appropriate on the left and right sides of an assignment, respectively. That is, r-values are what we usually think of as "values," while l-values are locations.

Static checking must assure that the left side of an assignment denotes an l-value. An identifier like *i* has an l-value, as does an array access like **a**[2]. But a constant like **2** is not appropriate on the left side of an assignment, since it has an r-value, but not an l-value.

### Type Checking

Type checking assures that the type of a construct matches that expected by its context. For example, in the if-statement

$$\mathbf{if} ( \text{expr} ) \text{stmt}$$

the expression *expr* is expected to have type **boolean**.

Type checking rules follow the operator/operand structure of the abstract syntax. Assume the operator **rel** represents relational operators such as  $\leq$ . The type rule for the operator group **rel** is that its two operands must have the same type, and the result has type boolean. Using attribute *type* for the type of an expression, let *E* consist of **rel** applied to *E*<sub>1</sub> and *E*<sub>2</sub>. The type of *E* can be checked when its node is constructed, by executing code like the following:

```

if ( Ei.type == E.type ) E.type = boolean;
else error;

```

The idea of matching actual with expected types continues to apply, even in the following situations:

- *Coercions.* A *coercion* occurs if the type of an operand is automatically converted to the type expected by the operator. In an expression like  $2 * 3.14$ , the usual transformation is to convert the integer 2 into an equivalent floating-point number, 2.0, and then perform a floating-point operation on the resulting pair of floating-point operands. The language definition specifies the allowable coercions. For example, the actual rule for **rel** discussed above might be that *Ei.type* and *E.type* are convertible to the same type. In that case, it would be legal to compare, say, an integer with a float.
- *Overloading.* The operator + in Java represents addition when applied to integers; it means concatenation when applied to strings. A symbol is said to be *overloaded* if it has different meanings depending on its context. Thus, + is overloaded in Java. The meaning of an overloaded operator is determined by considering the known types of its operands and results. For example, we know that the + in  $\mathbf{z} = \mathbf{x} + \mathbf{y}$  is concatenation if we know that any of  $\mathbf{x}$ ,  $\mathbf{y}$ , or  $\mathbf{z}$  is of type string. However, if we also know that another one of these is of type integer, then we have a type error and there is no meaning to this use of +.

### 2.8.4 Three-Address Code

Once syntax trees are constructed, further analysis and synthesis can be done by evaluating attributes and executing code fragments at nodes in the tree. We illustrate the possibilities by walking syntax trees to generate three-address code. Specifically, we show how to write functions that process the syntax tree and, as a side-effect, emit the necessary three-address code.

#### Three-Address Instructions

Three-address code is a sequence of instructions of the form

$$x \text{ - } y \text{ op } z$$

where  $x$ ,  $y$ , and  $z$  are names, constants, or compiler-generated temporaries; and **op** stands for an operator.

Arrays will be handled by using the following two variants of instructions:

$$\begin{aligned}
 x [ y ] & \text{ - } z \\
 x & = y [ z ]
 \end{aligned}$$

The first puts the value of  $z$  in the location  $x[y]$ , and the second puts the value of  $y[z]$  in the location  $x$ .

Three-address instructions are executed in numerical sequence unless forced to do otherwise by a conditional or unconditional jump. We choose the following instructions for control flow:

```

if False  $x$  goto L if  $\mathcal{F}$  is false, next execute the instruction labeled L
if True  $x$  goto L if  $\mathcal{R}$  is true, next execute the instruction labeled L
goto L                    next execute the instruction labeled L

```

A label  $L$  can be attached to any instruction by prepending a prefix  $L:$ . An instruction can have more than one label.

Finally, we need instructions that copy a value. The following three-address instruction copies the value of  $y$  into  $x$ :

$$x = y$$

### Translation of Statements

Statements are translated into three-address code by using jump instructions to implement the flow of control through the statement. The layout in Fig. 2.42 illustrates the translation of **if**  $expr$  **then**  $stmt_i$ . The jump instruction in the layout

```

if False  $x$  goto after

```

jumps over the translation of  $stmt_i$  if  $expr$  evaluates to **false**. Other statement constructs are similarly translated using appropriate jumps around the code for their components.

```

code to compute
   $expr$  into  $x$ 
if False  $x$  goto after
code for  $stmt_i$ 
after—*— ;

```

Figure 2.42: Code layout for if-statements

For concreteness, we show the pseudocode for class *If* in Fig. 2.43. Class *If* is a subclass of *Stmt*, as are the classes for the other statement constructs. Each subclass of *Stmt* has a constructor — // in this case — and a function *gen* that is called to generate three-address code for this kind of statement.

```

class // extends Stmt {
    Expr E; Stmt S;
    public If(Expr x, Stmt y) { E = x; S = y; after = newlabelQ; }
    public void gen() {
        Expr n = E.rvalueQ;
        emit( "ifFalse " + n.toStringQ + " goto " + after);
        S.genQ;
        emit (after + ":");
    }
}

```

Figure 2.43: Function *gen* in class // generates three-address code

The constructor // in Fig. 2.43 creates syntax-tree nodes for if-statements. It is called with two parameters, an expression node *x* and a statement node *y*, which it saves as attributes *E* and *S*. The constructor also assigns attribute *after* a unique new label, by calling function *newlabelQ*. The label will be used according to the layout in Fig. 2.42.

Once the entire syntax tree for a source program is constructed, the function *gen* is called at the root of the syntax tree. Since a program is a block in our simple language, the root of the syntax tree represents the sequence of statements in the block. All statement classes contain a function *gen*.

The pseudocode for function *gen* of class // in Fig. 2.43 is representative. It calls *E.rvalueQ* to translate the expression *E* (the boolean-valued expression that is part of the if-statements) and saves the result node returned by *E*. Translation of expressions will be discussed shortly. Function *gen* then emits a conditional jump and calls *S.genQ* to translate the substatement *S*.

### Translation of Expressions

We now illustrate the translation of expressions by considering expressions containing binary operators **op**, array accesses, and assignments, in addition to constants and identifiers. For simplicity, in an array access *y[z]*, we require that *y* be an identifier.<sup>13</sup> For a detailed discussion of intermediate code generation for expressions, see Section 6.4.

We shall take the simple approach of generating one three-address instruction for each operator node in the syntax tree for an expression. No code is generated for identifiers and constants, since they can appear as addresses in instructions. If a node *x* of class *Expr* has operator **op**, then an instruction is emitted to compute the value at node *x* into a compiler generated "temporary" name, say *t*. Thus, *i-j+k* translates into two instructions

<sup>13</sup>This simple language supports **a[a[n]]**, but not **a[m][n]**. Note that **a[a[n]]** has the form **a[£?]**, where *E* is **a[n]**.

```
t1 = i - j
t2 = t1 + k
```

With array accesses and assignments comes the need to distinguish between /-values and r-values. For example,  $2 * \mathbf{a}[i]$  can be translated by computing the r-value of  $\mathbf{a}[i]$  into a temporary, as in

```
t1 = a [ i ]
t2 = 2 * t1
```

But, we cannot simply use a temporary in place of  $\mathbf{a}[i]$ , if  $\mathbf{a}[i]$  appears on the left side of an assignment.

The simple approach uses the two functions *lvalue* and *rvalue*, which appear in Fig. 2.44 and 2.45, respectively. When function *rvalue* is applied to a nonleaf node  $x$ , it generates instructions to compute  $x$  into a temporary, and returns a new node representing the temporary. When function *lvalue* is applied to a nonleaf, it also generates instructions to compute the subtrees below  $x$ , and returns a node representing the "address" for  $x$ .

We describe function *lvalue* first, since it has fewer cases. When applied to a node  $x$ , function *lvalue* simply returns  $x$  if it is the node for an identifier (i.e., if  $x$  is of class *Id*). In our simple language, the only other case where an expression has an /-value occurs when  $x$  represents an array access, such as  $\mathbf{a}[i]$ . In this case,  $x$  will have the form *Access*( $y, z$ ), where class *Access* is a subclass of *Expr*,  $y$  represents the name of the accessed array, and  $z$  represents the offset (index) of the chosen element in that array. From the pseudo-code in Fig. 2.44, function *lvalue* calls *rvalue*( $z$ ) to generate instructions, if needed, to compute the r-value of  $z$ . It then constructs and returns a new *Access* node with children for the array name  $y$  and the r-value of  $z$ .

```
Expr lvalue(x : Expr) {
  if ( x is an Id node ) return x;
  else if ( x is an Access (y, z) node and y is an Id node ) {
    return new Access(y, rvalue(z));
  }
  else error;
}
```

Figure 2.44: Pseudocode for function *lvalue*

**Example 2.19:** When node  $x$  represents the array access  $\mathbf{a}[2 * \mathbf{k}]$ , the call *lvalue*( $x$ ) generates an instruction

```
t = 2 * k
```

and returns a new node  $x'$  representing the /-value  $\mathbf{a}[t]$ , where  $t$  is a new temporary name.

In detail, the code fragment

```
return new Access(y, rvalue(z));
```

is reached with  $y$  being the node for  $\mathbf{a}$  and  $z$  being the node for expression  $2*k$ . The call  $rvalue(z)$  generates code for the expression  $2*k$  (i.e., the three-address statement  $t = 2 * k$ ) and returns the new node  $z'$  representing the temporary name  $t$ . That node  $z'$  becomes the value of the second field in the new *Access* node  $x'$  that is created. •

```
Expr rvalue(x : Expr) {
  if ( x is an Id or a Constant node ) return x;
  else if ( x is an Op(op,y,z) or a Rel(op,y,z) node ) {
    t = new temporary;
    emit string for t = rvalue(y) op rvalue(z);
    return a new node for t;
  }
  else if ( x is an Access (y,z) node ) {
    t = new temporary;
    call lvalue(x), which returns Access(y, z');
    emit string for t = Access(y, z')
    return a new node for t;
  }
  else if ( x is an Assign (y, z) node ) {
    z' = rvalue(z)
    emit string for lvalue(y) = z';
    return z';
  }
}
```

Figure 2.45: Pseudocode for function *rvalue*

Function *rvalue* in Fig. 2.45 generates instructions and returns a possibly new node. When  $x$  represents an identifier or a constant, *rvalue* returns  $x$  itself. In all other cases, it returns an *Id* node for a new temporary  $t$ . The cases are as follows:

- When  $x$  represents  $y \mathbf{op} z$ , the code first computes  $y' = rvalue(y)$  and  $z' = rvalue(z)$ . It creates a new temporary  $t$  and generates an instruction  $t = y' \mathbf{op} z'$  (more precisely, an instruction formed from the string representations of  $t$ ,  $y'$ ,  $\mathbf{op}$ , and  $z'$ ). It returns a node for identifier  $t$ .
- When  $x$  represents an array access  $ylz]$ , we can reuse function *lvalue*. The call *lvalue(x)* returns an access  $y[ z' ]$ , where  $z'$  represents an identifier holding the offset for the array access. The code creates a new temporary  $t$ , generates an instruction based on  $t = ytz'$ , and returns a node for  $t$ .

- When  $x$  represents  $y = z$ , then the code first computes  $z' = rvalue(z)$ . It generates an instruction based on  $lvalue(y) = z'$  and returns the node  $z'$ .

**Example 2.20:** When applied to the syntax tree for

$$\mathbf{a[i] = 2 * a[j-k]}$$

function *rvalue* generates

```

t3 = j - k
t2 = a [ t3 ]
t1 = 2 * t2
a [ i ] = t1

```

That is, the root is an *Assign* node with first argument  $\mathbf{a[i]}$  and second argument  $\mathbf{2 * a[j-k]}$ . Thus, the third case applies, and function *rvalue* recursively evaluates  $\mathbf{2 * a[j-k]}$ . The root of this subtree is the *Op* node for  $*$ , which causes a new temporary  $\mathbf{t1}$  to be created, before the left operand,  $\mathbf{2}$  is evaluated, and then the right operand. The constant  $\mathbf{2}$  generates no three-address code, and its r-value is returned as a *Constant* node with value 2.

The right operand  $\mathbf{a[j-k]}$  is an *Access* node, which causes a new temporary  $\mathbf{t2}$  to be created, before function *lvalue* is called on this node. Recursively, *rvalue* is called on the expression  $\mathbf{j-k}$ . As a side-effect of this call, the three-address statement  $\mathbf{t3 = j - k}$  is generated, after the new temporary  $\mathbf{t3}$  is created. Then, returning to the call of *lvalue* on  $\mathbf{a[j-k]}$ , the temporary  $\mathbf{t2}$  is assigned the r-value of the entire access-expression, that is,  $\mathbf{t2 = a [ t3 ]}$ .

Now, we return to the call of *rvalue* on the *Op* node  $\mathbf{2 * a[j-k]}$ , which earlier created temporary  $\mathbf{t1}$ . A three-address statement  $\mathbf{t1 = 2 * t2}$  is generated as a side-effect, to evaluate this multiplication-expression. Last, the call to *rvalue* on the whole expression completes by calling *lvalue* on the left side  $\mathbf{a[i]}$  and then generating a three-address instruction  $\mathbf{a [ i ] = t1}$ , in which the right side of the assignment is assigned to the left side. •

### Better Code for Expressions

We can improve on function *rvalue* in Fig. 2.45 and generate fewer three-address instructions, in several ways:

- Reduce the number of copy instructions in a subsequent optimization phase. For example, the pair of instructions  $\mathbf{t = i+1}$  and  $\mathbf{i = t}$  can be combined into  $\mathbf{i = i+1}$ , if there are no subsequent uses of  $\mathbf{t}$ .
- Generate fewer instructions in the first place by taking context into account. For example, if the left side of a three-address assignment is an array access  $\mathbf{a[t]}$ , then the right side must be a name, a constant, or a temporary, all of which use just one address. But if the left side is a name  $\mathbf{x}$ , then the right side can be an operation  $\mathbf{y op z}$  that uses two addresses.

We can avoid some copy instructions by modifying the translation functions to generate a partial instruction that computes, say  $j+k$ , but does not commit to where the result is to be placed, signified by a **null** address for the result:

$$\mathbf{null} = j + k \quad (2.8)$$

The null result address is later replaced by either an identifier or a temporary, as appropriate. It is replaced by an identifier if  $j+k$  is on the right side of an assignment, as in  $i=j+k$ ; in which case (2.8) becomes

$$i = j + k$$

But, if  $j+k$  is a subexpression, as in  $j+k+1$ , then the null result address in (2.8) is replaced by a new temporary **t**, and a new partial instruction is generated

$$\begin{aligned} \mathbf{t} &= j + k \\ \mathbf{null} &= \mathbf{t} + 1 \end{aligned}$$

Many compilers make every effort to generate code that is as good as or better than hand-written assembly code produced by experts. If code-optimization techniques, such as the ones in Chapter 9 are used, then an effective strategy may well be to use a simple approach for intermediate code generation, and rely on the code optimizer to eliminate unnecessary instructions.

### 2.8.5 Exercises for Section 2.8

Exercise 2.8.1: For-statements in C and Java have the form:

```
for ( expr1 ; expr2 ; expr3 ) stmt
```

The first expression is executed before the loop; it is typically used for initializing the loop index. The second expression is a test made before each iteration of the loop; the loop is exited if the expression becomes 0. The loop itself can be thought of as the statement  $\{ \mathit{stmt} \ \mathit{expr}_2 ; \}$ . The third expression is executed at the end of each iteration; it is typically used to increment the loop index. The meaning of the for-statement is similar to

```
expr1; while ( expr2 ) { stmt expr3; }
```

Define a class *For* for for-statements, similar to class *//in* in Fig. 2.43.

Exercise 2.8.2: The programming language C does not have a boolean type. Show how a C compiler might translate an if-statement into three-address code.

## 2.9 Summary of Chapter 2

The syntax-directed techniques in this chapter can be used to construct compiler front ends, such as those illustrated in Fig. 2.46.



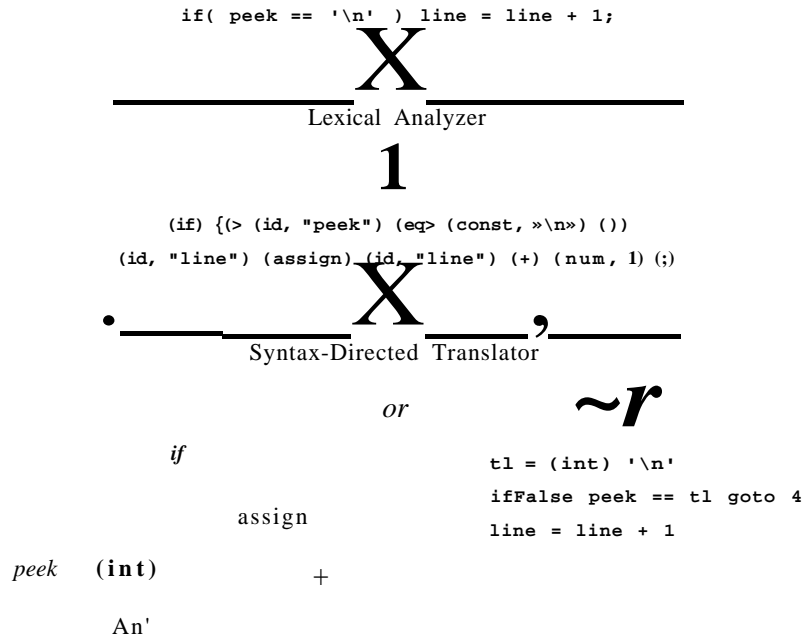

Figure 2.46: Two possible translations of a statement

- The starting point for a syntax-directed translator is a grammar for the source language. A *grammar* describes the hierarchical structure of programs. It is defined in terms of elementary symbols called *terminals* and variable symbols called *nonterminals*. These symbols represent language constructs. The rules or *productions* of a grammar consist of a nonterminal called the *head* or *left side* of a production and a sequence of terminals and nonterminals called the *body* or *right side* of the production. One nonterminal is designated as the *start* symbol.
- In specifying a translator, it is helpful to attach attributes to programming construct, where an *attribute* is any quantity associated with a construct. Since constructs are represented by grammar symbols, the concept of attributes extends to grammar symbols. Examples of attributes include an integer value associated with a terminal **num** representing numbers, and a string associated with a terminal **id** representing identifiers.
- A *lexical analyzer* reads the input one character at a time and produces as output a stream of *tokens*, where a token consists of a terminal symbol along with additional information in the form of attribute values. In Fig. 2.46, tokens are written as tuples enclosed between ( ). The token (**id**, "peek") consists of the terminal **id** and a pointer to the symbol-table entry containing the string "peek". The translator uses the table to keep

track of reserved words and identifiers that have already been seen.

- 4- *Parsing* is the problem of figuring out how a string of terminals can be derived from the start symbol of the grammar by repeatedly replacing a nonterminal by the body of one of its productions. Conceptually, a parser builds a parse tree in which the root is labeled with the start symbol, each nonleaf corresponds to a production, and each leaf is labeled with a terminal or the empty string  $\epsilon$ . The parse tree derives the string of terminals at the leaves, read from left to right.
- 4\* Efficient parsers can be built by hand, using a top-down (from the root to the leaves of a parse tree) method called predictive parsing. A *predictive parser* has a procedure for each nonterminal; procedure bodies mimic the productions for nonterminals; and, the flow of control through the procedure bodies can be determined unambiguously by looking one symbol ahead in the input stream. See Chapter 4 for other approaches to parsing.
- Syntax-directed translation is done by attaching either rules or program fragments to productions in a grammar. In this chapter, we have considered only *synthesized* attributes — the value of a synthesized attribute at any node  $x$  can depend only on attributes at the children of  $x$ , if any. A *syntax-directed definition* attaches rules to productions; the rules compute attribute values. A *translation scheme* embeds program fragments called *semantic actions* in production bodies. The actions are executed in the order that productions are used during syntax analysis.
- The result of syntax analysis is a representation of the source program, called *intermediate code*. Two primary forms of intermediate code are illustrated in Fig. 2.46. An *abstract syntax tree* has nodes for programming constructs; the children of a node give the meaningful sub constructs. Alternatively, *three-address code* is a sequence of instructions in which each instruction carries out a single operation.
- *Symbol tables* are data structures that hold information about identifiers. Information is put into the symbol table when the declaration of an identifier is analyzed. A semantic action gets information from the symbol table when the identifier is subsequently used, for example, as a factor in an expression.



## Chapter 3

# Lexical Analysis

In this chapter we show how to construct a lexical analyzer. To implement a lexical analyzer by hand, it helps to start with a diagram or other description for the lexemes of each token. We can then write code to identify each occurrence of each lexeme on the input and to return information about the token identified.

We can also produce a lexical analyzer automatically by specifying the lexeme patterns to a *lexical-analyzer generator* and compiling those patterns into code that functions as a lexical analyzer. This approach makes it easier to modify a lexical analyzer, since we have only to rewrite the affected patterns, not the entire program. It also speeds up the process of implementing the lexical analyzer, since the programmer specifies the software at the very high level of patterns and relies on the generator to produce the detailed code. We shall introduce in Section 3.5 a lexical-analyzer generator called *Lex* (or *Flex* in a more recent embodiment).

We begin the study of lexical-analyzer generators by introducing regular expressions, a convenient notation for specifying lexeme patterns. We show how this notation can be transformed, first into nondeterministic automata and then into deterministic automata. The latter two notations can be used as input to a "driver," that is, code which simulates these automata and uses them as a guide to determining the next token. This driver and the specification of the automaton form the nucleus of the lexical analyzer.

### 3.1 The Role of the Lexical Analyzer

As the first phase of a compiler, the main task of the lexical analyzer is to read the input characters of the source program, group them into lexemes, and produce as output a sequence of tokens for each lexeme in the source program. The stream of tokens is sent to the parser for syntax analysis. It is common for the lexical analyzer to interact with the symbol table as well. When the lexical analyzer discovers a lexeme constituting an identifier, it needs to enter that lexeme into the symbol table. In some cases, information regarding the

kind of identifier may be read from the symbol table by the lexical analyzer to assist it in determining the proper token it must pass to the parser.

These interactions are suggested in Fig. 3.1. Commonly, the interaction is implemented by having the parser call the lexical analyzer. The call, suggested by the *getNextToken* command, causes the lexical analyzer to read characters from its input until it can identify the next lexeme and produce for it the next token, which it returns to the parser.

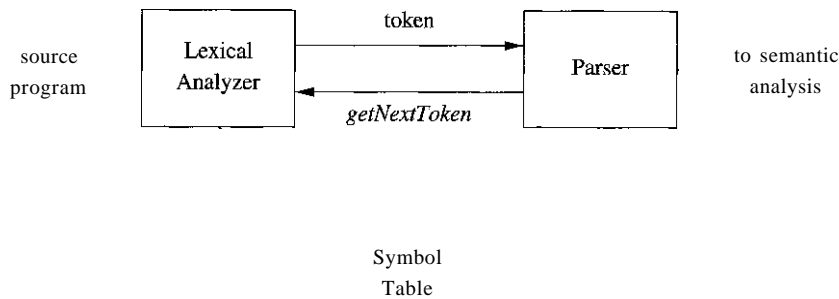

Figure 3.1: Interactions between the lexical analyzer and the parser

Since the lexical analyzer is the part of the compiler that reads the source text, it may perform certain other tasks besides identification of lexemes. One such task is stripping out comments and *whitespace* (blank, newline, tab, and perhaps other characters that are used to separate tokens in the input). Another task is correlating error messages generated by the compiler with the source program. For instance, the lexical analyzer may keep track of the number of newline characters seen, so it can associate a line number with each error message. In some compilers, the lexical analyzer makes a copy of the source program with the error messages inserted at the appropriate positions. If the source program uses a macro-preprocessor, the expansion of macros may also be performed by the lexical analyzer.

Sometimes, lexical analyzers are divided into a cascade of two processes:

- a) *Scanning* consists of the simple processes that do not require tokenization of the input, such as deletion of comments and compaction of consecutive whitespace characters into one.
- b) *Lexical analysis* proper is the more complex portion, where the scanner produces the sequence of tokens as output.

### 3.1.1 Lexical Analysis Versus Parsing

There are a number of reasons why the analysis portion of a compiler is normally separated into lexical analysis and parsing (syntax analysis) phases.

1. Simplicity of design is the most important consideration. The separation of lexical and syntactic analysis often allows us to simplify at least one of these tasks. For example, a parser that had to deal with comments and whitespace as syntactic units would be considerably more complex than one that can assume comments and whitespace have already been removed by the lexical analyzer. If we are designing a new language, separating lexical and syntactic concerns can lead to a cleaner overall language design.
2. Compiler efficiency is improved. A separate lexical analyzer allows us to apply specialized techniques that serve only the lexical task, not the job of parsing. In addition, specialized buffering techniques for reading input characters can speed up the compiler significantly.
3. Compiler portability is enhanced. Input-device-specific peculiarities can be restricted to the lexical analyzer.

### 3.1.2 Tokens, Patterns, and Lexemes

When discussing lexical analysis, we use three related but distinct terms:

- A *token* is a pair consisting of a token name and an optional attribute value. The token name is an abstract symbol representing a kind of lexical unit, e.g., a particular keyword, or a sequence of input characters denoting an identifier. The token names are the input symbols that the parser processes. In what follows, we shall generally write the name of a token in boldface. We will often refer to a token by its token name.
- A *pattern* is a description of the form that the lexemes of a token may take. In the case of a keyword as a token, the pattern is just the sequence of characters that form the keyword. For identifiers and some other tokens, the pattern is a more complex structure that is *matched* by many strings.
- A *lexeme* is a sequence of characters in the source program that matches the pattern for a token and is identified by the lexical analyzer as an instance of that token.

Example 3.1: Figure 3.2 gives some typical tokens, their informally described patterns, and some sample lexemes. To see how these concepts are used in practice, in the C statement

```
printf("Total = %d\n", score);
```

both `printf` and `score` are lexemes matching the pattern for token `id`, and `"Total = %d\n"` is a lexeme matching literal. •

In many programming languages, the following classes cover most or all of the tokens:

TOKEN	INFORMAL DESCRIPTION	SAMPLE LEXEMES
<b>if</b>	characters <b>i, f</b>	<b>if</b>
<b>else</b>	characters <b>e, l, s, e</b>	<b>else</b>
<b>comparison</b>	< or > or <= or >= or == or !=	<=, !=
<b>id</b>	letter followed by letters and digits	<b>pi, score, D2</b>
<b>number</b>	any numeric constant	<b>3.14159, 0, 6.02e23</b>
<b>literal</b>	anything but ", surrounded by ""s	<b>"core dumped"</b>

Figure 3.2: Examples of tokens

1. One token for each keyword. The pattern for a keyword is the same as the keyword itself.
2. Tokens for the operators, either individually or in classes such as the token `comparison` mentioned in Fig. 3.2.
3. One token representing all identifiers.
4. One or more tokens representing constants, such as numbers and literal strings.
5. Tokens for each punctuation symbol, such as left and right parentheses, comma, and semicolon.

### 3.1.3 Attributes for Tokens

When more than one lexeme can match a pattern, the lexical analyzer must provide the subsequent compiler phases additional information about the particular lexeme that matched. For example, the pattern for token `number` matches both 0 and 1, but it is extremely important for the code generator to know which lexeme was found in the source program. Thus, in many cases the lexical analyzer returns to the parser not only a token name, but an attribute value that describes the lexeme represented by the token; the token name influences parsing decisions, while the attribute value influences translation of tokens after the parse.

We shall assume that tokens have at most one associated attribute, although this attribute may have a structure that combines several pieces of information. The most important example is the token `id`, where we need to associate with the token a great deal of information. Normally, information about an identifier — e.g., its lexeme, its type, and the location at which it is first found (in case an error message about that identifier must be issued) — is kept in the symbol table. Thus, the appropriate attribute value for an identifier is a pointer to the symbol-table entry for that identifier.

### Tricky Problems When Recognizing Tokens

Usually, given the pattern describing the lexemes of a token, it is relatively simple to recognize matching lexemes when they occur on the input. However, in some languages it is not immediately apparent when we have seen an instance of a lexeme corresponding to a token. The following example is taken from Fortran, in the fixed-format still allowed in Fortran 90. In the statement

```
DO 5 I = 1.25
```

it is not apparent that the first lexeme is D05I, an instance of the identifier token, until we see the dot following the 1. Note that blanks in fixed-format Fortran are ignored (an archaic convention). Had we seen a comma instead of the dot, we would have had a do-statement

```
DO 5 I = 1,25
```

in which the first lexeme is the keyword DO.

**Example 3.2:** The token names and associated attribute values for the Fortran statement

```
E = M * C ** 2
```

are written below as a sequence of pairs.

```
<id, pointer to symbol-table entry for E>
<assign_op>
<id, pointer to symbol-table entry for M>
<mult_op>
<id, pointer to symbol-table entry for C>
<exp_op>
<number, integer value 2>
```

Note that in certain pairs, especially operators, punctuation, and keywords, there is no need for an attribute value. In this example, the token **number** has been given an integer-valued attribute. In practice, a typical compiler would instead store a character string representing the constant and use as an attribute value for **number** a pointer to that string. •

#### 3.1.4 Lexical Errors

It is hard for a lexical analyzer to tell, without the aid of other components, that there is a source-code error. For instance, if the string `fi` is encountered for the first time in a C program in the context:



```
fi ( a == f(x)) ...
```

a lexical analyzer cannot tell whether `fi` is a misspelling of the keyword `if` or an undeclared function identifier. Since `fi` is a valid lexeme for the token `id`, the lexical analyzer must return the token `id` to the parser and let some other phase of the compiler — probably the parser in this case — handle an error due to transposition of the letters.

However, suppose a situation arises in which the lexical analyzer is unable to proceed because none of the patterns for tokens matches any prefix of the remaining input. The simplest recovery strategy is "panic mode" recovery. We delete successive characters from the remaining input, until the lexical analyzer can find a well-formed token at the beginning of what input is left. This recovery technique may confuse the parser, but in an interactive computing environment it may be quite adequate.

Other possible error-recovery actions are:

1. Delete one character from the remaining input.
2. Insert a missing character into the remaining input.
3. Replace a character by another character.
4. Transpose two adjacent characters.

Transformations like these may be tried in an attempt to repair the input. The simplest such strategy is to see whether a prefix of the remaining input can be transformed into a valid lexeme by a single transformation. This strategy makes sense, since in practice most lexical errors involve a single character. A more general correction strategy is to find the smallest number of transformations needed to convert the source program into one that consists only of valid lexemes, but this approach is considered too expensive in practice to be worth the effort.

### 3.1.5 Exercises for Section 3.1

Exercise **3.1.1**: Divide the following C++ program:

```
float limitedSquare(x) float x {
    /* returns x-squared, but never more than 100 */
    return (x<=-10.0||x>=10.0)?100:x*x;
}
```

into appropriate lexemes, using the discussion of Section 3.1.2 as a guide. Which lexemes should get associated lexical values? What should those values be?

! Exercise **3.1.2**: Tagged languages like HTML or XML are different from conventional programming languages in that the punctuation (tags) are either very numerous (as in HTML) or a user-definable set (as in XML). Further, tags can often have parameters. Suggest how to divide the following HTML document:

```

Here is a photo of <B>my house</B>:
<PXIMG SRC = "house.gif"><BR>
See <A HREF = "morePix.html">More Pictures</A> if you
liked that one.<P>

```

into appropriate lexemes. Which lexemes should get associated lexical values, and what should those values be?

## 3.2 Input Buffering

Before discussing the problem of recognizing lexemes in the input, let us examine some ways that the simple but important task of reading the source program can be speeded. This task is made difficult by the fact that we often have to look one or more characters beyond the next lexeme before we can be sure we have the right lexeme. The box on "Tricky Problems When Recognizing Tokens" in Section 3.1 gave an extreme example, but there are many situations where we need to look at least one additional character ahead. For instance, we cannot be sure we've seen the end of an identifier until we see a character that is not a letter or digit, and therefore is not part of the lexeme for `id`. In C, single-character operators like `-`, `=`, or `<` could also be the beginning of a two-character operator like `->`, `==`, or `<=`. Thus, we shall introduce a two-buffer scheme that handles large lookaheads safely. We then consider an improvement involving "sentinels" that saves time checking for the ends of buffers.

### 3.2.1 Buffer Pairs

Because of the amount of time taken to process characters and the large number of characters that must be processed during the compilation of a large source program, specialized buffering techniques have been developed to reduce the amount of overhead required to process a single input character. An important scheme involves two buffers that are alternately reloaded, as suggested in Fig. 3.3.

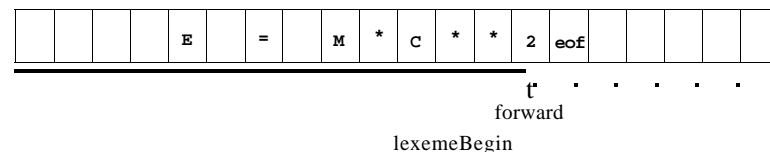

Figure 3.3: Using a pair of input buffers

Each buffer is of the same size  $N$ , and  $N$  is usually the size of a disk block, e.g., 4096 bytes. Using one system read command we can read  $N$  characters into a buffer, rather than using one system call per character. If fewer than  $N$  characters remain in the input file, then a special character, represented by `eof`,

marks the end of the source file and is different from any possible character of the source program.

Two pointers to the input are maintained:

1. Pointer **lexemeBegin**, marks the beginning of the current lexeme, whose extent we are attempting to determine.
2. Pointer **forward** scans ahead until a pattern match is found; the exact strategy whereby this determination is made will be covered in the balance of this chapter.

Once the next lexeme is determined, **forward** is set to the character at its right end. Then, after the lexeme is recorded as an attribute value of a token returned to the parser, **lexemeBegin** is set to the character immediately after the lexeme just found. In Fig. 3.3, we see **forward** has passed the end of the next lexeme, **\*\*** (the Fortran exponentiation operator), and must be retracted one position to its left.

Advancing **forward** requires that we first test whether we have reached the end of one of the buffers, and if so, we must reload the other buffer from the input, and move **forward** to the beginning of the newly loaded buffer. As long as we never need to look so far ahead of the actual lexeme that the sum of the lexeme's length plus the distance we look ahead is greater than  $N$ , we shall never overwrite the lexeme in its buffer before determining it.

### 3.2.2 Sentinels

If we use the scheme of Section 3.2.1 as described, we must check, each time we advance **forward**, that we have not moved off one of the buffers; if we do, then we must also reload the other buffer. Thus, for each character read, we make two tests: one for the end of the buffer, and one to determine what character is read (the latter may be a multiway branch). We can combine the buffer-end test with the test for the current character if we extend each buffer to hold a *sentinel* character at the end. The sentinel is a special character that cannot be part of the source program, and a natural choice is the character **eof**.

Figure 3.4 shows the same arrangement as Fig. 3.3, but with the sentinels added. Note that **eof** retains its use as a marker for the end of the entire input. Any **eof** that appears other than at the end of a buffer means that the input is at an end. Figure 3.5 summarizes the algorithm for advancing **forward**. Notice how the first test, which can be part of a multiway branch based on the character pointed to by **forward**, is the only test we make, except in the case where we actually are at the end of a buffer or the end of the input.

## 3.3 Specification of Tokens

Regular expressions are an important notation for specifying lexeme patterns. While they cannot express all possible patterns, they are very effective in spec-



```

switch ( *forward++ ) {
  case eof:
    if (forward is at end of first buffer ) {
      reload second buffer;
      forward = beginning of second buffer;
    }
    else if (forward is at end of second buffer ) {
      reload first buffer;
      forward = beginning of first buffer;
    }
    else /* eof within a buffer marks the end of input */
      terminate lexical analysis;
    break;
  Cases for the other characters
}

```

Figure 3.5: Lookahead code with sentinels

## Implementing Multiway Branches

We might imagine that the switch in Fig. 3.5 requires many steps to execute, and that placing the case `eof` first is not a wise choice. Actually, it doesn't matter in what order we list the cases for each character. In practice, a multiway branch depending on the input character is made in one step by jumping to an address found in an array of addresses, indexed by characters.

code, which includes approximately 100,000 characters from alphabets around the world, is another important example of an alphabet.

A *string* over an alphabet is a finite sequence of symbols drawn from that alphabet. In language theory, the terms "sentence" and "word" are often used as synonyms for "string." The length of a string  $s$ , usually written  $|s|$ , is the number of occurrences of symbols in  $s$ . For example, banana is a string of length six. The *empty string*, denoted  $\epsilon$ , is the string of length zero.

A *language* is any countable set of strings over some fixed alphabet. This definition is very broad. Abstract languages like  $\emptyset$ , the *empty set*, or  $\{\epsilon\}$ , the set containing only the empty string, are languages under this definition. So too are the set of all syntactically well-formed C programs and the set of all grammatically correct English sentences, although the latter two languages are difficult to specify exactly. Note that the definition of "language" does not require that any meaning be ascribed to the strings in the language. Methods for defining the "meaning" of strings are discussed in Chapter 5.

### Terms for Parts of Strings

The following string-related terms are commonly used:

1. A *prefix* of string  $s$  is any string obtained by removing zero or more symbols from the end of  $s$ . For example, *ban*, *banana*, and *e* are prefixes of *banana*.
2. A *suffix* of string  $s$  is any string obtained by removing zero or more symbols from the beginning of  $s$ . For example, *nana*, *banana*, and *e* are suffixes of *banana*.
3. A *substring* of  $s$  is obtained by deleting any prefix and any suffix from  $s$ . For instance, *banana*, *nan*, and *e* are substrings of *banana*.
4. The *proper* prefixes, suffixes, and substrings of a string  $s$  are those, prefixes, suffixes, and substrings, respectively, of  $s$  that are not  $e$  or not equal to  $s$  itself.
5. A *subsequence* of  $s$  is any string formed by deleting zero or more not necessarily consecutive positions of  $s$ . For example, *baan* is a subsequence of *banana*.

If  $x$  and  $y$  are strings, then the *concatenation* of  $x$  and  $y$ , denoted  $xy$ , is the string formed by appending  $y$  to  $x$ . For example, if  $x = \text{dog}$  and  $y = \text{house}$ , then  $xy = \text{doghouse}$ . The empty string is the identity under concatenation; that is, for any string  $s$ ,  $es = se = s$ .

If we think of concatenation as a product, we can define the "exponentiation" of strings as follows. Define  $s^0$  to be  $e$ , and for all  $i > 0$ , define  $s^i$  to be  $s^{i-1}s$ . Since  $es = s$ , it follows that  $s^1 = s$ . Then  $s^2 = ss$ ,  $s^3 = sss$ , and so on.

### 3.3.2 Operations on Languages

In lexical analysis, the most important operations on languages are union, concatenation, and closure, which are defined formally in Fig. 3.6. Union is the familiar operation on sets. The concatenation of languages is all strings formed by taking a string from the first language and a string from the second language, in all possible ways, and concatenating them. The (*Kleene*) *closure* of a language  $L$ , denoted  $L^*$ , is the set of strings you get by concatenating  $L$  zero or more times. Note that  $L^0$ , the "concatenation of  $L$  zero times," is defined to be  $\{e\}$ , and inductively,  $U$  is  $L^*L$ . Finally, the positive closure, denoted  $L^+$ , is the same as the Kleene closure, but without the term  $L^0$ . That is,  $e$  will not be in  $L^+$  unless it is in  $L$  itself.

OPERATION	DEFINITION AND NOTATION
<i>Union of L and M</i>	$L \cup M = \{s \mid s \text{ is in } L \text{ or } s \text{ is in } M\}$
<i>Concatenation of L and M</i>	$LM = \{st \mid s \text{ is in } L \text{ and } t \text{ is in } M\}$
<i>Kleene closure of L</i>	$L^* = \cup_{i \geq 0} L^i$
<i>Positive closure of L</i>	

Figure 3.6: Definitions of operations on languages

**Example 3.3** Let  $L$  be the set of letters  $\{A, B, \dots, Z, a, b, \dots, z\}$  and let  $D$  be the set of digits  $\{0, 1, \dots, 9\}$ . We may think of  $L$  and  $D$  in two, essentially equivalent, ways. One way is that  $L$  and  $D$  are, respectively, the alphabets of uppercase and lowercase letters and of digits. The second way is that  $L$  and  $D$  are languages, all of whose strings happen to be of length one. Here are some other languages that can be constructed from languages  $L$  and  $D$ , using the operators of Fig. 3.6:

1.  $L \cup D$  is the set of letters and digits — strictly speaking the language with 62 strings of length one, each of which strings is either one letter or one digit.
2.  $LD$  is the set of 520 strings of length two, each consisting of one letter followed by one digit.
3.  $L^4$  is the set of all 4-letter strings.
4.  $L^*$  is the set of all strings of letters, including  $\epsilon$ , the empty string.
5.  $L(L \cup D)^*$  is the set of all strings of letters and digits beginning with a letter.
6.  $D^+$  is the set of all strings of one or more digits.

•

### 3.3.3 Regular Expressions

Suppose we wanted to describe the set of valid C identifiers. It is almost exactly the language described in item (5) above; the only difference is that the underscore is included among the letters.

In Example 3.3, we were able to describe identifiers by giving names to sets of letters and digits and using the language operators union, concatenation, and closure. This process is so useful that a notation called *regular expressions* has come into common use for describing all the languages that can be built from these operators applied to the symbols of some alphabet. In this notation, if *letter*- is established to stand for any letter or the underscore, and *digit*- is

established to stand for any digit, then we could describe the language of C identifiers by:

$$\textit{letter} \bar{\cup} ( \textit{letter} \bar{\cup} \textit{digit} )^*$$

The vertical bar above means union, the parentheses are used to group subexpressions, the star means "zero or more occurrences of," and the juxtaposition of *letter*, with the remainder of the expression signifies concatenation.

The regular expressions are built recursively out of smaller regular expressions, using the rules described below. Each regular expression  $r$  denotes a language  $L(r)$ , which is also defined recursively from the languages denoted by  $r$ 's subexpressions. Here are the rules that define the regular expressions over some alphabet  $\Sigma$  and the languages that those expressions denote.

**BASIS:** There are two rules that form the basis:

1.  $\epsilon$  is a regular expression, and  $L(\epsilon)$  is  $\{\epsilon\}$ , that is, the language whose sole member is the empty string.
2. If  $a$  is a symbol in  $\Sigma$ , then  $\mathbf{a}$  is a regular expression, and  $L(\mathbf{a}) = \{a\}$ , that is, the language with one string, of length one, with  $a$  in its one position. Note that by convention, we use italics for symbols, and boldface for their corresponding regular expression.<sup>1</sup>

**INDUCTION:** There are four parts to the induction whereby larger regular expressions are built from smaller ones. Suppose  $r$  and  $s$  are regular expressions denoting languages  $L(r)$  and  $L(s)$ , respectively.

1.  $(r)|(s)$  is a regular expression denoting the language  $L(r) \cup L(s)$ .
2.  $(r)(s)$  is a regular expression denoting the language  $L(r)L(s)$ .
3.  $(r)^*$  is a regular expression denoting  $(L(r))^*$ .
4.  $(r)$  is a regular expression denoting  $L(r)$ . This last rule says that we can add additional pairs of parentheses around expressions without changing the language they denote.

As defined, regular expressions often contain unnecessary pairs of parentheses. We may drop certain pairs of parentheses if we adopt the conventions that:

- a) The unary operator  $*$  has highest precedence and is left associative.
- b) Concatenation has second highest precedence and is left associative.

however, when talking about specific characters from the ASCII character set, we shall generally use teletype font for both the character and its regular expression.



c)  $|$  has lowest precedence and is left associative.

Under these conventions, for example, we may replace the regular expression  $(\mathbf{a})|((\mathbf{b})^*(\mathbf{c}))$  by  $\mathbf{a|b}^*\mathbf{c}$ . Both expressions denote the set of strings that are either a single  $a$  or are zero or more  $b$ 's followed by one  $c$ .

**Example 3.4:** Let  $\Sigma = \{a, b\}$ .

1. The regular expression  $\mathbf{a|b}$  denotes the language  $\{a, b\}$ .
2.  $\mathbf{(a|b)(a|b)}$  denotes  $\{aa, ab, ba, bb\}$ , the language of all strings of length two over the alphabet  $\Sigma$ . Another regular expression for the same language is  $\mathbf{aa|ab|ba|bb}$ .
3.  $\mathbf{a^*}$  denotes the language consisting of all strings of zero or more  $a$ 's, that is,  $\{e, a, aa, aaa, \dots\}$ .
4.  $\mathbf{(a|b)^*}$  denotes the set of all strings consisting of zero or more instances of  $a$  or  $b$ , that is, all strings of  $a$ 's and  $b$ 's:  $\{e, a, b, aa, ab, ba, bb, aaa, \dots\}$ . Another regular expression for the same language is  $\mathbf{(a^*b^*)^*}$ .
5.  $\mathbf{a|a^*b}$  denotes the language  $\{a, b, ab, aab, aaab, \dots\}$ , that is, the string  $a$  and all strings consisting of zero or more  $a$ 's and ending in  $b$ .

•

A language that can be defined by a regular expression is called a *regular set*. If two regular expressions  $r$  and  $s$  denote the same regular set, we say they are *equivalent* and write  $r = s$ . For instance,  $\mathbf{(a|b) = (b|a)}$ . There are a number of algebraic laws for regular expressions; each law asserts that expressions of two different forms are equivalent. Figure 3.7 shows some of the algebraic laws that hold for arbitrary regular expressions  $r$ ,  $s$ , and  $t$ .

LAW	DESCRIPTION
$r s = s r$	$ $ is commutative
$r (s t) = (r s) t$	$ $ is associative
$r(st) = (rs)t$	Concatenation is associative
$r(s t) = rs rt; (s t)r = sr tr$	Concatenation distributes over $ $
$er = re = r$	$e$ is the identity for concatenation
$r^* = (r e)^*$	$e$ is guaranteed in a closure
	$*$ is idempotent

Figure 3.7: Algebraic laws for regular expressions

### 3.3.4 Regular Definitions

For notational convenience, we may wish to give names to certain regular expressions and use those names in subsequent expressions, as if the names were themselves symbols. If  $\Sigma$  is an alphabet of basic symbols, then a *regular definition* is a sequence of definitions of the form:

$$\begin{aligned} d_1 &\rightarrow \mathbf{n} \\ d_2 &\rightarrow \mathbf{r}_2 \\ &\vdots \\ d_n &\rightarrow \mathbf{r}_n \end{aligned}$$

where:

1. Each  $d_i$  is a new symbol, not in  $\Sigma$  and not the same as any other of the  $d_j$ 's, and
2. Each  $\mathbf{r}_i$  is a regular expression over the alphabet  $\Sigma \cup \{d_1, d_2, \dots, d_{i-1}\}$ .

By restricting  $\Sigma$  to  $\Sigma$  and the previously defined **GTS**, we avoid recursive definitions, and we can construct a regular expression over  $\Sigma$  alone, for each  $\mathbf{r}_i$ . We do so by first replacing uses of  $d_i$  in  $\mathbf{r}_i$  (which cannot use any of the  $d_j$ 's except for  $d_i$ ), then replacing uses of  $d_i$  and  $d_j$  in  $\mathbf{r}_i$  by  $\mathbf{r}_i$  and (the substituted)  $\mathbf{r}_j$ , and so on. Finally, in  $\mathbf{r}_n$  we replace each  $d_i$ , for  $i = 1, 2, \dots, n-1$ , by the substituted version of  $\mathbf{r}_i$ , each of which has only symbols of  $\Sigma$ .

Example 3.5: C identifiers are strings of letters, digits, and underscores. Here is a regular definition for the language of C identifiers. We shall conventionally use italics for the symbols defined in regular definitions.

$$\begin{aligned} \textit{letter} &\rightarrow \mathbf{A | B | \dots | Z | a | b | \dots | z | \_} \\ \textit{digit} &\rightarrow \mathbf{0 | 1 | \dots | 9} \\ \textit{id} &\rightarrow \mathbf{\textit{letter} ( \textit{letter} \setminus \textit{digit} )^*} \end{aligned}$$

Example 3.6: Unsigned numbers (integer or floating point) are strings such as **5280**, **0.01234**, **6.336E4**, or **1.89E-4**. The regular definition

$$\begin{aligned} \textit{digit} &\rightarrow \mathbf{0 | 1 | \dots | 9} \\ \textit{digits} &\rightarrow \mathbf{\textit{digit} \textit{digit}^*} \\ \textit{optionalFraction} &\rightarrow \mathbf{. \textit{digits} | \epsilon} \\ \textit{optionalExponent} &\rightarrow \mathbf{( \mathbf{E} ( + | - | \epsilon ) \textit{digits} ) | \epsilon} \\ \textit{number} &\rightarrow \mathbf{\textit{digits} \textit{optionalFraction} \textit{optionalExponent}} \end{aligned}$$

is a precise specification for this set of strings. That is, an *optionalFraction* is either a decimal point (dot) followed by one or more digits, or it is missing (the empty string). An *optionalExponent*, if not missing, is the letter E followed by an optional + or - sign, followed by one or more digits. Note that at least one digit must follow the dot, so *number* does not match **1.**, but does match **1.0**.

### 3.3.5 Extensions of Regular Expressions

Since Kleene introduced regular expressions with the basic operators for union, concatenation, and Kleene closure in the 1950s, many extensions have been added to regular expressions to enhance their ability to specify string patterns. Here we mention a few notational extensions that were first incorporated into Unix utilities such as Lex that are particularly useful in the specification lexical analyzers. The references to this chapter contain a discussion of some regular-expression variants in use today.

1. *One or more instances.* The unary, postfix operator  $^+$  represents the positive closure of a regular expression and its language. That is, if  $r$  is a regular expression, then  $(r)^+$  denotes the language  $(L(r))^+$ . The operator  $^+$  has the same precedence and associativity as the operator  $*$ . Two useful algebraic laws,  $r^* = r^+e$  and  $r^+ = rr^* = r^*r$  relate the Kleene closure and positive closure.
2. *Zero or one instance.* The unary postfix operator  $?$  means "zero or one occurrence." That is,  $r?$  is equivalent to  $r|e$ , or put another way,  $L(r?) = L(r) \cup \{e\}$ . The  $?$  operator has the same precedence and associativity as  $*$  and  $^+$ .
3. *Character classes.* A regular expression  $a_1a_2 \dots a_n$ , where the  $a^i$ s are each symbols of the alphabet, can be replaced by the shorthand  $[a_1a_2 \dots a_n]$ . More importantly, when  $01, 02, \dots, a_n$  form a logical sequence, e.g., consecutive uppercase letters, lowercase letters, or digits, we can replace them by  $oi-a_n$ , that is, just the first and last separated by a hyphen. Thus,  $[abc]$  is shorthand for  $a|b|c$ , and  $[a-z]$  is shorthand for  $a|b|\dots|z$ .

**Example 3.7:** Using these shorthands, we can rewrite the regular definition of Example 3.5 as:

```
letter  ->  [A-Za-z_]
digit   ->  [0-9]
id      ->  letter- ( letter \ digit )*
```

The regular definition of Example 3.6 can also be simplified:

```
digit   ->  [0-9]
digits  ->• digit
number  ->• digits ( digits)? ( E [+-]? digits )?
```

•

### 3.3.6 Exercises for Section 3.3

**Exercise 3.3.1:** Consult the language reference manuals to determine (i) the sets of characters that form the input alphabet (excluding those that may only appear in character strings or comments), (ii) the lexical form of numerical constants, and (iii) the lexical form of identifiers, for each of the following languages: (a) C (b) C++ (c) C# (d) Fortran (e) Java (f) Lisp (g) SQL.

**! Exercise 3.3.2:** Describe the languages denoted by the following regular expressions:

- a)  $a(a|b)^*a$ .
- b)  $((e|a)b^*)^*$ .
- c)  $(a|b)^*a(a|b)(a|b)$ .
- d)  $a^*ba^*ba^*ba^*$ .

!! e)  $(aa|bb)^*((ab|ba)(aa|bb)^*(ab|ba)(aa|bb)^*)^*$ .

**Exercise 3.3.3:** In a string of length  $n$ , how many of the following are there?

- a) Prefixes.
- b) Suffixes.
- c) Proper prefixes.
- ! d) Substrings.
- ! e) Subsequences.

**Exercise 3.3.4:** Most languages are *case sensitive*, so keywords can be written only one way, and the regular expressions describing their lexeme is very simple. However, some languages, like SQL, are *case insensitive*, so a keyword can be written either in lowercase or in uppercase, or in any mixture of cases. Thus, the SQL keyword **SELECT** can also be written **select**, **Select**, or **sEIECT**, for instance. Show how to write a regular expression for a keyword in a case-insensitive language. Illustrate the idea by writing the expression for "select" in SQL.

**! Exercise 3.3.5:** Write regular definitions for the following languages:

- a) All strings of lowercase letters that contain the five vowels in order.
- b) All strings of lowercase letters in which the letters are in ascending lexicographic order.
- c) Comments, consisting of a string surrounded by `/*` and `*/`, without an intervening `*/`, unless it is inside double-quotes (`"`).

- !! d) All strings of digits with no repeated digits. *Hint:* Try this problem first with a few digits, such as {0,1,2}.
- !! e) All strings of digits with at most one repeated digit.
- !! f) All strings of a's and 6's with an even number of a's and an odd number of 6's.
- g) The set of Chess moves, in the informal notation, such as p-k4 or kbpqxqn.
- !! h) All strings of a's and 6's that do not contain the substring a66.
- i) All strings of a's and 6's that do not contain the subsequence a66.

Exercise **3.3.6:** Write character classes for the following sets of characters:

- a) The first ten letters (up to "j") in either upper or lower case.
- b) The lowercase consonants.
- c) The "digits" in a hexadecimal number (choose either upper or lower case for the "digits" above 9).
- d) The characters that can appear at the end of a legitimate English sentence (e.g., exclamation point).

The following exercises, up to and including Exercise 3.3.10, discuss the extended regular-expression notation from Lex (the lexical-analyzer generator that we shall discuss extensively in Section 3.5). The extended notation is listed in Fig. 3.8.

Exercise **3.3.7:** Note that these regular expressions give all of the following symbols (*operator characters*) a special meaning:

\ » . ~ \$ [ ] \* + ? { } | /

Their special meaning must be turned off if they are needed to represent themselves in a character string. We can do so by quoting the character within a string of length one or more; e.g., the regular expression "\*\*\*" matches the string \*\*. We can also get the literal meaning of an operator character by preceding it by a backslash. Thus, the regular expression \\*\\* also matches the string \*\*. Write a regular expression that matches the string "\.

Exercise **3.3.8:** In Lex, a *complemented character class* represents any character except the ones listed in the character class. We denote a complemented class by using ~ as the first character; this symbol (caret) is not itself part of the class being complemented, unless it is listed within the class itself. Thus, [~A-Za-z] matches any character that is not an uppercase or lowercase letter, and [~\~] represents any character but the caret (or newline, since newline cannot be in any character class). Show that for every regular expression with complemented character classes, there is an equivalent regular expression without complemented character classes.

EXPRESSION	MATCHES	EXAMPLE
$c$	the one non-operator character $c$	<b>a</b>
$V$	character $c$ literally	$\backslash*$
$  s  $	string $s$ literally	"**"
$.$	any character but newline	<b>a.</b> *b
$^$	beginning of a line	~abc
$\$$	end of a line	abc\$
$[s]$	any one of the characters in string $s$	[abc]
$[^s]$	any one character not in string $s$	[~abc]
$r^*$	zero or more strings matching $r$	<b>a*</b>
$r^+$	one or more strings matching $r$	<b>a+</b>
$r?$	zero or one $r$	<b>a?</b>
$r\{m, n\}$	between $m$ and $n$ occurrences of $r$	<b>a[1,5]</b>
$ri r_2$	an $r_1$ followed by an $r_2$	ab
$r_1   r_2$	an $r_1$ or an $r_2$	<b>a b</b>
$(r)$	same as $r$	(alb)
$ri/r_2$	$r_1$ when followed by $r_2$	abc/123

Figure 3.8: Lex regular expressions

**! Exercise 3.3.9:** The regular expression  $r\{m, n\}$  matches from  $m$  to  $n$  occurrences of the pattern  $r$ . For example, **a[1,5]** matches a string of one to five a's. Show that for every regular expression containing repetition operators of this form, there is an equivalent regular expression without repetition operators.

**! Exercise 3.3.10:** The operator  $^$  matches the left end of a line, and  $\$$  matches the right end of a line. The operator  $~$  is also used to introduce complemented character classes, but the context always makes it clear which meaning is intended. For example,  $~[~aeiou]^*$  matches any complete line that does not contain a lowercase vowel.

- How do you tell which meaning of  $^$  is intended?
- Can you always replace a regular expression using the  $^$  and  $\$$  operators by an equivalent expression that does not use either of these operators?

**! Exercise 3.3.11:** The UNIX shell command **sh** uses the operators in Fig. 3.9 in filename expressions to describe sets of file names. For example, the filename expression  $*.o$  matches all file names ending in **.o**; **sort1.?** matches all file names of the form **sort.c**, where  $c$  is any character. Show how **sh** filename

EXPRESSION	MATCHES	EXAMPLE
$v$	string $s$ literally	' $v$
$V$	character $c$ literally	$v$
$*$	any string	$*.o$
$?$	any character	$sortl.?$
$[s]$	any character in $s$	$sortl.[cso]$

Figure 3.9: Filename expressions used by the shell command `sh`

expressions can be replaced by equivalent regular expressions using only the basic union, concatenation, and closure operators.

**! Exercise 3.3.12:** SQL allows a rudimentary form of patterns in which two characters have special meaning: underscore (`_`) stands for any one character and percent-sign (`%`) stands for any string of 0 or more characters. In addition, the programmer may define any character, say `e`, to be the escape character, so `e` preceding an `e` preceding `_`, `%` or another `e` gives the character that follows its literal meaning. Show how to express any SQL pattern as a regular expression, given that we know which character is the escape character.

### 3.4 Recognition of Tokens

In the previous section we learned how to express patterns using regular expressions. Now, we must study how to take the patterns for all the needed tokens and build a piece of code that examines the input string and finds a prefix that is a lexeme matching one of the patterns. Our discussion will make use of the following running example.

$$\begin{array}{lcl}
 stmt & \rightarrow & \mathbf{if\ expr\ then\ stmt} \\
 & & | \mathbf{if\ expr\ then\ stmt\ else\ stmt} \\
 & & \mathbf{I} \\
 & & e \\
 expr & \rightarrow & \mathbf{term\ relop\ term} \\
 & & | \mathbf{term} \\
 term & \rightarrow & \mathbf{id} \\
 & & | \mathbf{number}
 \end{array}$$

Figure 3.10: A grammar for branching statements

**Example 3.8:** The grammar fragment of Fig. 3.10 describes a simple form of branching statements and conditional expressions. This syntax is similar to that of the language Pascal, in that **then** appears explicitly after conditions.

For **relop**, we use the comparison operators of languages like Pascal or SQL, where = is "equals" and <> is "not equals," because it presents an interesting structure of lexemes.

The terminals of the grammar, which are **if**, **then**, **else**, **relop**, **id**, and **number**, are the names of tokens as far as the lexical analyzer is concerned. The patterns for these tokens are described using regular definitions, as in Fig. 3.11. The patterns for *id* and *number* are similar to what we saw in Example 3.7.

```

digit  ->  [0-9]
digits        digit
number       digits ( . digits)? ( E [+]? digits )?
letter       [A-Za-z]
id           letter ( letter \ digit )*
if           ->  if
then         then
else         else
relop        < 1 > 1 <= 1 >= 1 = 1 <>

```

Figure 3.11: Patterns for tokens of Example 3.8

For this language, the lexical analyzer will recognize the keywords **if**, **then**, and **else**, as well as lexemes that match the patterns for *relop*, *id*, and *number*. To simplify matters, we make the common assumption that keywords are also *reserved words*: that is, they are not identifiers, even though their lexemes match the pattern for identifiers.

In addition, we assign the lexical analyzer the job of stripping out whitespace, by recognizing the "token" *ws* defined by:

```
ws -> ( blank | tab | newline )*
```

Here, **blank**, **tab**, and **newline** are abstract symbols that we use to express the ASCII characters of the same names. Token *ws* is different from the other tokens in that, when we recognize it, we do not return it to the parser, but rather restart the lexical analysis from the character that follows the whitespace. It is the following token that gets returned to the parser.

Our goal for the lexical analyzer is summarized in Fig. 3.12. That table shows, for each lexeme or family of lexemes, which token name is returned to the parser and what attribute value, as discussed in Section 3.1.3, is returned. Note that for the six relational operators, symbolic constants **LT**, **LE**, and so on are used as the attribute value, in order to indicate which instance of the token **relop** we have found. The particular operator found will influence the code that is output from the compiler. •



LEXEMES	TOKEN NAME	ATTRIBUTE VALUE
Any <i>ws</i>	-	-
if	<b>if</b>	-
<b>then</b>	<b>then</b>	-
<b>else</b>	<b>else</b>	-
Any <i>id</i>	<b>id</b>	Pointer to table entry
Any <i>number</i>	<b>number</b>	Pointer to table entry
<	<b>relop</b>	LT
<=	<b>relop</b>	LE
=	<b>relop</b>	EQ
<>	<b>relop</b>	NE
>	<b>relop</b>	GT
>=	<b>relop</b>	

Figure 3.12: Tokens, their patterns, and attribute values

### 3.4.1 Transition Diagrams

As an intermediate step in the construction of a lexical analyzer, we first convert patterns into stylized flowcharts, called "transition diagrams." In this section, we perform the conversion from regular-expression patterns to transition diagrams by hand, but in Section 3.6, we shall see that there is a mechanical way to construct these diagrams from collections of regular expressions.

*Transition diagrams* have a collection of nodes or circles, called *states*. Each state represents a condition that could occur during the process of scanning the input looking for a lexeme that matches one of several patterns. We may think of a state as summarizing all we need to know about what characters we have seen between the *lexemeBegin* pointer and the *forward* pointer (as in the situation of Fig. 3.3).

*Edges* are directed from one state of the transition diagram to another. Each edge is *labeled* by a symbol or set of symbols. If we are in some state **S**, and the next input symbol is *a*, we look for an edge out of state *s* labeled by *a* (and perhaps by other symbols, as well). If we find such an edge, we advance the *forward* pointer and enter the state of the transition diagram to which that edge leads. We shall assume that all our transition diagrams are *deterministic*, meaning that there is never more than one edge out of a given state with a given symbol among its labels. Starting in Section 3.5, we shall relax the condition of determinism, making life much easier for the designer of a lexical analyzer, although trickier for the implementer. Some important conventions about transition diagrams are:

1. Certain states are said to be *accepting*, or *final*. These states indicate that a lexeme has been found, although the actual lexeme may not consist of all positions between the *lexemeBegin* and *forward* pointers. We always

indicate an accepting state by a double circle, and if there is an action to be taken — typically returning a token and an attribute value to the parser — we shall attach that action to the accepting state.

2. In addition, if it is necessary to retract the *forward* pointer one position (i.e., the lexeme does not include the symbol that got us to the accepting state), then we shall additionally place a \* near that accepting state. In our example, it is never necessary to retract *forward* by more than one position, but if it were, we could attach any number of \*'s to the accepting state.
3. One state is designated the *start state*, or *initial state*; it is indicated by an edge, labeled "start," entering from nowhere. The transition diagram always begins in the start state before any input symbols have been read.

**Example 3.9:** Figure 3.13 is a transition diagram that recognizes the lexemes matching the token **relop**. We begin in state 0, the start state. If we see < as the first input symbol, then among the lexemes that match the pattern for **relop** we can only be looking at <, <>, or <=. We therefore go to state 1, and look at the next character. If it is =, then we recognize lexeme <=, enter state 2, and return the token **relop** with attribute LE, the symbolic constant representing this particular comparison operator. If in state 1 the next character is >, then instead we have lexeme <>, and enter state 3 to return an indication that the not-equals operator has been found. On any other character, the lexeme is <, and we enter state 4 to return that information. Note, however, that state 4 has a \* to indicate that we must retract the input one position.

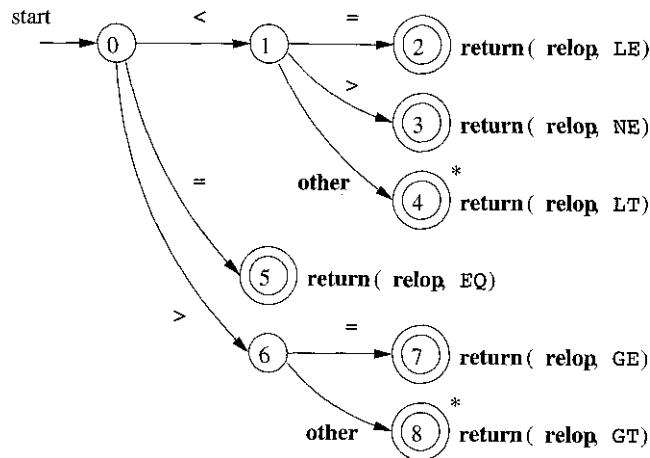

Figure 3.13: Transition diagram for **relop**

On the other hand, if in state 0 the first character we see is =, then this one character must be the lexeme. We immediately return that fact from state 5.

The remaining possibility is that the first character is `>`. Then, we must enter state 6 and decide, on the basis of the next character, whether the lexeme is `>=` (if we next see the `=` sign), or just `>` (on any other character). Note that if, in state 0, we see any character besides `<`, `=`, or `>`, we can not possibly be seeing a **relop** lexeme, so this transition diagram will not be used. •

### 3.4.2 Recognition of Reserved Words and Identifiers

Recognizing keywords and identifiers presents a problem. Usually, keywords like `if` or **then** are reserved (as they are in our running example), so they are not identifiers even though they *look* like identifiers. Thus, although we typically use a transition diagram like that of Fig. 3.14 to search for identifier lexemes, this diagram will also recognize the keywords `if`, **then**, and **else** of our running example.

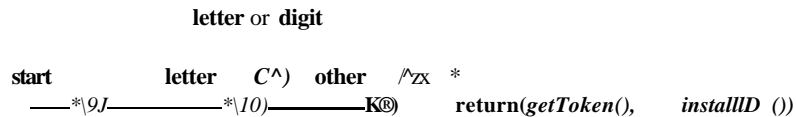

Figure 3.14: A transition diagram for **id**'s and keywords

There are two ways that we can handle reserved words that look like identifiers:

1. Install the reserved words in the symbol table initially. A field of the symbol-table entry indicates that these strings are never ordinary identifiers, and tells which token they represent. We have supposed that this method is in use in Fig. 3.14. When we find an identifier, a call to *installID* places it in the symbol table if it is not already there and returns a pointer to the symbol-table entry for the lexeme found. Of course, any identifier not in the symbol table during lexical analysis cannot be a reserved word, so its token is **id**. The function *getToken* examines the symbol table entry for the lexeme found, and returns whatever token name the symbol table says this lexeme represents — either **id** or one of the keyword tokens that was initially installed in the table.
2. Create separate transition diagrams for each keyword; an example for the keyword **then** is shown in Fig. 3.15. Note that such a transition diagram consists of states representing the situation after each successive letter of the keyword is seen, followed by a test for a "nonletter-or-digit," i.e., any character that cannot be the continuation of an identifier. It is necessary to check that the identifier has ended, or else we would return token **then** in situations where the correct token was **id**, with a lexeme like `thennextvalue` that has **then** as a proper prefix. If we adopt this approach, then we must prioritize the tokens so that the reserved-word

tokens are recognized in preference to `id`, when the lexeme matches both patterns. We *do not* use this approach in our example, which is why the states in Fig. 3.15 are unnumbered.

Figure 3.15: Hypothetical transition diagram for the keyword `then`

### 3.4.3 Completion of the Running Example

The transition diagram for `id`'s that we saw in Fig. 3.14 has a simple structure. Starting in state 9, it checks that the lexeme begins with a letter and goes to state 10 if so. We stay in state 10 as long as the input contains letters and digits. When we first encounter anything but a letter or digit, we go to state 11 and accept the lexeme found. Since the last character is not part of the identifier, we must retract the input one position, and as discussed in Section 3.4.2, we enter what we have found in the symbol table and determine whether we have a keyword or a true identifier.

The transition diagram for token `number` is shown in Fig. 3.16, and is so far the most complex diagram we have seen. Beginning in state 12, if we see a digit, we go to state 13. In that state, we can read any number of additional digits. However, if we see anything but a digit or a dot, we have seen a number in the form of an integer; 123 is an example. That case is handled by entering state 20, where we return token `number` and a pointer to a table of constants where the found lexeme is entered. These mechanics are not shown on the diagram but are analogous to the way we handled identifiers.

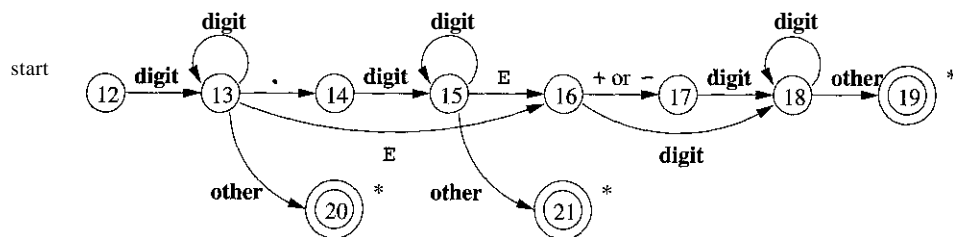

Figure 3.16: A transition diagram for unsigned numbers

If we instead see a dot in state 13, then we have an "optional fraction." State 14 is entered, and we look for one or more additional digits; state 15 is used for that purpose. If we see an `E`, then we have an "optional exponent," whose recognition is the job of states 16 through 19. Should we, in state 15, instead see anything but `E` or a digit, then we have come to the end of the fraction, there is no exponent, and we return the lexeme found, via state 21.

The final transition diagram, shown in Fig. 3.17, is for whitespace. In that diagram, we look for one or more "whitespace" characters, represented by **delim** in that diagram — typically these characters would be blank, tab, newline, and perhaps other characters that are not considered by the language design to be part of any token.

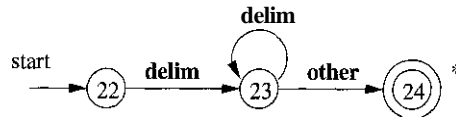

Figure 3.17: A transition diagram for whitespace

Note that in state 24, we have found a block of consecutive whitespace characters, followed by a nonwhitespace character. We retract the input to begin at the nonwhitespace, but we do not return to the parser. Rather, we must restart the process of lexical analysis after the whitespace.

### 3.4.4 Architecture of a Transition-Diagram-Based Lexical Analyzer

There are several ways that a collection of transition diagrams can be used to build a lexical analyzer. Regardless of the overall strategy, each state is represented by a piece of code. We may imagine a variable state holding the number of the current state for a transition diagram. A switch based on the value of state takes us to code for each of the possible states, where we find the action of that state. Often, the code for a state is itself a switch statement or multiway branch that determines the next state by reading and examining the next input character.

**Example 3.10:** In Fig. 3.18 we see a sketch of `getRelopO`, a C++ function whose job is to simulate the transition diagram of Fig. 3.13 and return an object of type `TOKEN`, that is, a pair consisting of the token name (which must be **relop** in this case) and an attribute value (the code for one of the six comparison operators in this case). `getRelopO` first creates a new object `retToken` and initializes its first component to **RELOP**, the symbolic code for token **relop**.

We see the typical behavior of a state in case 0, the case where the current state is 0. A function `nextChar()` obtains the next character from the input and assigns it to local variable `c`. We then check `c` for the three characters we expect to find, making the state transition dictated by the transition diagram of Fig. 3.13 in each case. For example, if the next input character is `=`, we go to state 5.

If the next input character is not one that can begin a comparison operator, then a function `fail()` is called. What `fail()` does depends on the global error-recovery strategy of the lexical analyzer. It should reset the forward pointer to `lexemeBegin`, in order to allow another transition diagram to be applied to

```

TOKEN getRelop0
{
    TOKEN retToken = new(RELOP);
    while(1) { /* repeat character processing until a return
                or failure occurs */
        switch(state) {
            case 0: c = nextCharQ;
                    if ( c == '<>' ) state = 1;
                    else if ( c == '=' ) state = 5;
                    else if ( c == '>' ) state = 6;
                    else fail(); /* lexeme is not a relop */
                    break;
            case 1: ...

            case 8: retract();
                    retToken.attribute = GT;
                    return(retToken);
        }
    }
}

```

Figure 3.18: Sketch of implementation of **relop** transition diagram

the true beginning of the unprocessed input. It might then change the value of **state** to be the start state for another transition diagram, which will search for another token. Alternatively, if there is no other transition diagram that remains unused, **fail()** could initiate an error-correction phase that will try to repair the input and find a lexeme, as discussed in Section 3.1.4.

We also show the action for state 8 in Fig. 3.18. Because state 8 bears a \*, we must retract the input pointer one position (i.e., put *c* back on the input stream). That task is accomplished by the function **retract()**. Since state 8 represents the recognition of lexeme **>=**, we set the second component of the returned object, which we suppose is named **attribute**, to **GT**, the code for this operator. •

To place the simulation of one transition diagram in perspective, let us consider the ways code like Fig. 3.18 could fit into the entire lexical analyzer.

1. We could arrange for the transition diagrams for each token to be tried sequentially. Then, the function **fail()** of Example 3.10 resets the pointer **forward** and starts the next transition diagram, each time it is called. This method allows us to use transition diagrams for the individual keywords, like the one suggested in Fig. 3.15. We have only to use these before we use the diagram for **id**, in order for the keywords to be reserved words.

2. We could run the various transition diagrams "in parallel," feeding the next input character to all of them and allowing each one to make whatever transitions it required. If we use this strategy, we must be careful to resolve the case where one diagram finds a lexeme that matches its pattern, while one or more other diagrams are still able to process input. The normal strategy is to take the longest prefix of the input that matches any pattern. That rule allows us to prefer identifier thenext to keyword then, or the operator -> to -, for example.
3. The preferred approach, and the one we shall take up in the following sections, is to combine all the transition diagrams into one. We allow the transition diagram to read input until there is no possible next state, and then take the longest lexeme that matched any pattern, as we discussed in item (2) above. In our running example, this combination is easy, because no two tokens can start with the same character; i.e., the first character immediately tells us which token we are looking for. Thus, we could simply combine states 0, 9, 12, and 22 into one start state, leaving other transitions intact. However, in general, the problem of combining transition diagrams for several tokens is more complex, as we shall see shortly.

### 3.4.5 Exercises for Section 3.4

Exercise 3.4.1: Provide transition diagrams to recognize the same languages as each of the regular expressions in Exercise 3.3.2.

Exercise 3.4.2: Provide transition diagrams to recognize the same languages as each of the regular expressions in Exercise 3.3.5.

The following exercises, up to Exercise 3.4.12, introduce the Aho-Corasick algorithm for recognizing a collection of keywords in a text string in time proportional to the length of the text and the sum of the length of the keywords. This algorithm uses a special form of transition diagram called a *trie*. A trie is a tree-structured transition diagram with distinct labels on the edges leading from a node to its children. Leaves of the trie represent recognized keywords.

Knuth, Morris, and Pratt presented an algorithm for recognizing a single keyword  $K$  in a text string. Here the trie is a transition diagram with  $n$  states, 0 through  $n$ . State 0 is the initial state, and state  $n$  represents acceptance, that is, discovery of the keyword. From each state  $s$  from 0 through  $n - 1$ , there is a transition to state  $s + 1$ , labeled by symbol  $b_s$ . For example, the trie for the keyword ababaa is:



In order to process text strings rapidly and search those strings for a keyword, it is useful to define, for keyword  $K$  and position  $s$  in that keyword (corresponding to state  $s$  of its trie), a *failure function*,  $f(s)$ , computed as in

Fig. 3.19. The objective is that  $f(s)$  be the longest proper prefix of  $b_1 b_2 \dots b_s$  that is also a suffix of  $b_1 b_2 \dots b_s$ . The reason  $f(s)$  is important is that if we are trying to match a text string for  $b_1 b_2 \dots b_s$ , and we have matched the first  $s$  positions, but we then fail (i.e., the next position of the text string does not hold  $b_{s+1}$ ), then  $f(s)$  is the longest prefix of  $b_1 b_2 \dots b_s$  that could possibly match the text string up to the point we are at. Of course, the next character of the text string must be  $b_{s+1}$ , or else we still have problems and must consider a yet shorter prefix, which will be  $f(s)$ .

```

1)  t = 0;
2)  f(1) = 0;
3)  for (s = 1; s < n; s++) {
4)      while (t > 0 && b_{s-t} != b_{s+1}) t = f(t);
5)      if (b_s == b_{s+1}) {
6)          t = t + 1;
7)          f(s + 1) = t;
8)      }
9)      else f(s + 1) = 0;
10) }

```

Figure 3.19: Algorithm to compute the failure function for keyword  $b_1 b_2 \dots b_n$ .

As an example, the failure function for the trie constructed above for **ababaa** is:

$s$	1	2	3	4	5	6
$f(s)$	0	0	1	2	3	1

For instance, states 3 and 1 represent prefixes **aba** and **a**, respectively.  $f(3) = 1$  because **a** is the longest proper prefix of **aba** that is also a suffix of **aba**. Also,  $f(2) = 0$ , because the longest proper prefix of **ab** that is also a suffix is the empty string.

**Exercise 3.4.3:** Construct the failure function for the strings:

- abababaab.
- aaaaaa.
- abbaabb.

**! Exercise 3.4.4:** Prove, by induction on  $s$ , that the algorithm of Fig. 3.19 correctly computes the failure function.

**!! Exercise 3.4.5:** Show that the assignment  $t = f(t)$  in line (4) of Fig. 3.19 is executed at most  $n$  times. Show that therefore, the entire algorithm takes only  $O(n)$  time on a keyword of length  $n$ .



Having computed the failure function for a keyword  $b_1 \cdot \cdot \cdot b_n$ , we can scan a string  $a_1 \cdot \cdot \cdot a_m$  in time  $O(m)$  to tell whether the keyword occurs in the string. The algorithm, shown in Fig. 3.20, slides the keyword along the string, trying to make progress by matching the next character of the keyword with the next character of the string. If it cannot do so after matching  $s$  characters, then it "slides" the keyword right  $s - f(s)$  positions, so only the first  $f(s)$  characters of the keyword are considered matched with the string.

```

1)  s = 0;
2)  for (i = 1; i < m; i++) {
3)      while (s > 0 && a_i != b_{s+1}) s = f(s);
4)      if (a_i == b_{s+1}) s = s + 1;
5)      if (s == n) return "yes";
    }
6)  return "no";

```

Figure 3.20: The KMP algorithm tests whether string  $a_1 \cdot \cdot \cdot a_m$  contains a single keyword  $b_1 \cdot \cdot \cdot b_n$  as a substring in  $O(m + n)$  time

**Exercise 3.4.6:** Apply Algorithm KMP to test whether keyword **ababaa** is a substring of:

- a) **abababaab.**
- b) **abababbaa.**

**!! Exercise 3.4.7:** Show that the algorithm of Fig. 3.20 correctly tells whether the keyword is a substring of the given string. *Hint:* proceed by induction on  $i$ . Show that for all  $i$ , the value of  $s$  after line (4) is the length of the longest prefix of the keyword that is a suffix of  $a_1 \cdot \cdot \cdot a_i$ .

**!! Exercise 3.4.8:** Show that the algorithm of Fig. 3.20 runs in time  $O(m + n)$ , assuming that function  $f$  is already computed and its values stored in an array indexed by  $s$ .

**Exercise 3.4.9:** The *Fibonacci strings* are defined as follows:

1.  $s_1 = \mathbf{b}$ .
2.  $s_2 = \mathbf{a}$ .
3.  $s_k = s_{k-1}s_{k-2}$  for  $k > 2$ .

For example,  $s_3 = \mathbf{ab}$ ,  $s_4 = \mathbf{aba}$ , and  $s_5 = \mathbf{abaab}$ .

- a) What is the length of  $s_n$ ?

- b) Construct the failure function for  $SQ$ .
- c) Construct the failure function for  $sj$ .
- !! d) Show that the failure function for any  $s_i$  can be expressed by  $f(1) = f(2) = 0$ , and for  $2 < j < |s|$ ,  $f(j)$  is  $j - |s_i|$ , where  $k$  is the largest integer such that  $k < j + 1$ .
- !! e) In the KMP algorithm, what is the largest number of consecutive applications of the failure function, when we try to determine whether keyword  $Sk$  appears in text string  $s^{+i}$ ?

Aho and Corasick generalized the KMP algorithm to recognize any of a set of keywords in a text string. In this case, the trie is a true tree, with branching from the root. There is one state for every string that is a prefix (not necessarily proper) of any keyword. The parent of a state corresponding to string  $b|b, \dots, bk$  is the state that corresponds to  $\&1\&2 \dots \&frfc-i-$ . A state is accepting if it corresponds to a complete keyword. For example, Fig. 3.21 shows the trie for the keywords he, she, his, and hers.

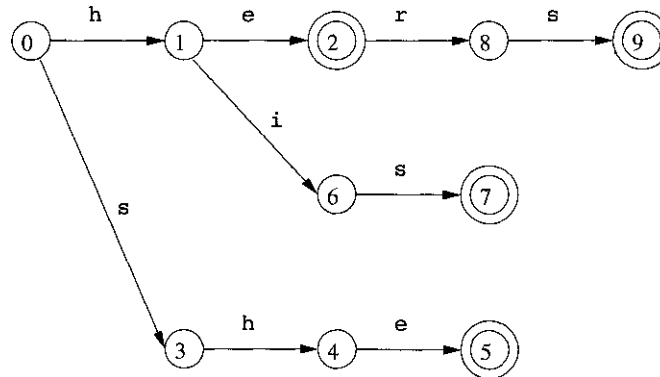

Figure 3.21: Trie for keywords he, she, his, hers

The failure function for the general trie is defined as follows. Suppose  $s$  is the state that corresponds to string  $\&i\&, \dots, b_s$ . Then  $f(s)$  is the state that corresponds to the longest proper suffix of  $\&i\&, \dots, b_s$  that is also a prefix of *some* keyword. For example, the failure function for the trie of Fig. 3.21 is:

$s$	1	2	3	4	5	6	7	8	9
$f(s)$	0	0	0	1	2	0	3	0	3

! Exercise 3.4.10: Modify the algorithm of Fig. 3.19 to compute the failure function for general tries. *Hint:* The major difference is that we cannot simply test for equality or inequality of  $b_{i+1}$  and  $b_i i$  in lines (4) and (5) of Fig. 3.19. Rather, from any state there may be several transitions out on several characters, as there are transitions on both e and i from state 1 in Fig. 3.21. Any of

those transitions could lead to a state that represents the longest suffix that is also a prefix.

Exercise 3.4.11: Construct the tries and compute the failure function for the following sets of keywords:

- a) aaa, abaaa, and ababaaa.
- b) all, fall, fatal, llama, and lame.
- c) pipe, pet, item, temper, and perpetual.

! Exercise 3.4.12: Show that your algorithm from Exercise 3.4.10 still runs in time that is linear in the sum of the lengths of the keywords.

## 3.5 The Lexical-Analyzer Generator Lex

In this section, we introduce a tool called Lex, or in a more recent implementation Flex, that allows one to specify a lexical analyzer by specifying regular expressions to describe patterns for tokens. The input notation for the Lex tool is referred to as the *Lex language* and the tool itself is the *Lex compiler*. Behind the scenes, the Lex compiler transforms the input patterns into a transition diagram and generates code, in a file called `lex.yy.c`, that simulates this transition diagram. The mechanics of how this translation from regular expressions to transition diagrams occurs is the subject of the next sections; here we only learn the Lex language.

### 3.5.1 Use of Lex

Figure 3.22 suggests how Lex is used. An input file, which we call `lex.l`, is written in the Lex language and describes the lexical analyzer to be generated. The Lex compiler transforms `lex.l` to a C program, in a file that is always named `lex.yy.c`. The latter file is compiled by the C compiler into a file called `a.out`, as always. The C-compiler output is a working lexical analyzer that can take a stream of input characters and produce a stream of tokens.

The normal use of the compiled C program, referred to as `a.out` in Fig. 3.22, is as a subroutine of the parser. It is a C function that returns an integer, which is a code for one of the possible token names. The attribute value, whether it be another numeric code, a pointer to the symbol table, or nothing, is placed in a global variable `yylval`,<sup>2</sup> which is shared between the lexical analyzer and parser, thereby making it simple to return both the name and an attribute value of a token.

Incidentally, the `yy` that appears in `yylval` and `lex.yy.c` refers to the **Yacc** parser-generator, which we shall describe in Section 4.9, and which is commonly used in conjunction with **Lex**.

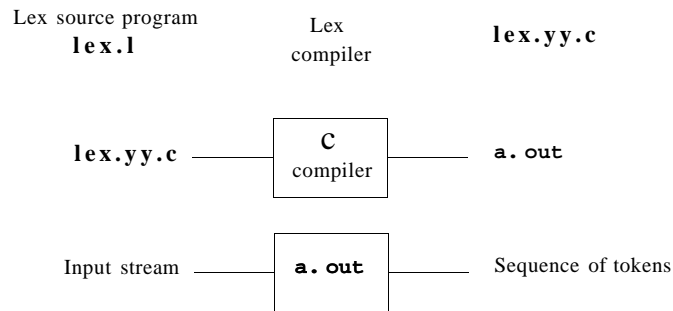
Figure 3.22: Creating a lexical analyzer with **Lex**

### 3.5.2 Structure of Lex Programs

A **Lex** program has the following form:

```

declarations
%7.
translation rules
%/.
auxiliary functions
  
```

The declarations section includes declarations of variables, *manifest constants* (identifiers declared to stand for a constant, e.g., the name of a token), and regular definitions, in the style of Section 3.3.4.

The translation rules each have the form

```
Pattern { Action }
```

Each pattern is a regular expression, which may use the regular definitions of the declaration section. The actions are fragments of code, typically written in C, although many variants of **Lex** using other languages have been created.

The third section holds whatever additional functions are used in the actions. Alternatively, these functions can be compiled separately and loaded with the lexical analyzer.

The lexical analyzer created by **Lex** behaves in concert with the parser as follows. When called by the parser, the lexical analyzer begins reading its remaining input, one character at a time, until it finds the longest prefix of the input that matches one of the patterns  $P_i$ . It then executes the associated action  $A_i$ . Typically,  $A_i$  will return to the parser, but if it does not (e.g., because  $P_i$  describes whitespace or comments), then the lexical analyzer proceeds to find additional lexemes, until one of the corresponding actions causes a return to the parser. The lexical analyzer returns a single value, the token name, to the parser, but uses the shared, integer variable `yylval` to pass additional information about the lexeme found, if needed.

Example 3.11: Figure 3.23 is a Lex program that recognizes the tokens of Fig. 3.12 and returns the token found. A few observations about this code will introduce us to many of the important features of Lex.

In the declarations section we see a pair of special brackets, `%{` and `%}`. Anything within these brackets is copied directly to the file `lex.yy.c`, and is not treated as a regular definition. It is common to place there the definitions of the manifest constants, using C `#define` statements to associate unique integer codes with each of the manifest constants. In our example, we have listed in a comment the names of the manifest constants, `LT`, `IF`, and so on, but have not shown them defined to be particular integers.<sup>3</sup>

Also in the declarations section is a sequence of regular definitions. These use the extended notation for regular expressions described in Section 3.3.5. Regular definitions that are used in later definitions or in the patterns of the translation rules are surrounded by curly braces. Thus, for instance, `delim` is defined to be a shorthand for the character class consisting of the blank, the tab, and the newline; the latter two are represented, as in all UNIX commands, by backslash followed by `t` or `n`, respectively. Then, `ws` is defined to be one or more delimiters, by the regular expression `{delim}+`.

Notice that in the definition of `id` and `number`, parentheses are used as grouping metasymbols and do not stand for themselves. In contrast, `E` in the definition of `number` stands for itself. If we wish to use one of the Lex metasymbols, such as any of the parentheses, `+`, `*`, or `?`, to stand for themselves, we may precede them with a backslash. For instance, we see `\.` in the definition of `number`, to represent the dot, since that character is a metasymbol representing "any character," as usual in UNIX regular expressions.

In the auxiliary-function section, we see two such functions, `installID()` and `installNumO`. Like the portion of the declaration section that appears between `%{. .%}`, everything in the auxiliary section is copied directly to file `lex.yy.c`, but may be used in the actions.

Finally, let us examine some of the patterns and rules in the middle section of Fig. 3.23. First, `ws`, an identifier declared in the first section, has an associated empty action. If we find whitespace, we do not return to the parser, but look for another lexeme. The second token has the simple regular expression pattern `if`. Should we see the two letters `if` on the input, and they are not followed by another letter or digit (which would cause the lexical analyzer to find a longer prefix of the input matching the pattern for `id`), then the lexical analyzer consumes these two letters from the input and returns the token name `IF`, that is, the integer for which the manifest constant `IF` stands. Keywords then and else are treated similarly.

The fifth token has the pattern defined by `id`. Note that, although keywords like `if` match this pattern as well as an earlier pattern, Lex chooses whichever

<sup>3</sup>If `Lex` is used along with `Yacc`, then it would be normal to define the manifest constants in the `Yacc` program and use them without definition in the `Lex` program. Since `lex.yy.c` is compiled with the `Yacc` output, the constants thus will be available to the actions in the `Lex` program.

```

U
/* definitions of manifest constants
   LT, LE, EQ, NE, GT, GE,
   IF, THEN, ELSE, ID, NUMBER, RELOP */
%}

/* regular definitions */
delim      [ \t\n]
ws         {delim}+
letter     [A-Za-z]
digit      [0-9]
id         {letter}({letter}|{digit})*
number     {digit}+(\.{digit}+)?(E[+-]?{digit}+)?

%/y.

{ws}       {/* no action and no return */}
if         {return(IF);}
then       {return(THEN);}
else       {return(ELSE);}
{id}       {yyval = (int) installID(); return(ID);}
{number}   {yyval = (int) installNumO ; return(NUMBER);}
"lt"      {yyval = LT; return(RELOP);}
"le"      {yyval = LE; return(RELOP);}
"="       {yyval = EQ; return(RELOP);}
">"      {yyval = NE; return(RELOP);}
">"      {yyval = GT; return(RELOP);}
">"      {yyval = GE; return(RELOP);}

int installlDQ {/* function to install the lexeme, whose
                first character is pointed to by yytext,
                arid whose length is yytext, into the
                symbol table and return a pointer
                thereto */

int installNumO {/* similar to installlD, but puts numer-
                  ical constants into a separate table */
}

```

Figure 3.23: Lex program for the tokens of Fig. 3.12

pattern is listed first in situations where the longest matching prefix matches two or more patterns. The action taken when *id* is matched is threefold:

1. Function `installID()` is called to place the lexeme found in the symbol table.
2. This function returns a pointer to the symbol table, which is placed in global variable `yylval`, where it can be used by the parser or a later component of the compiler. Note that `installID()` has available to it two variables that are set automatically by the lexical analyzer that Lex generates:
  - (a) `yyltext` is a pointer to the beginning of the lexeme, analogous to `lexemeBegin` in Fig. 3.3.
  - (b) `yyleng` is the length of the lexeme found.
3. The token name `ID` is returned to the parser.

The action taken when a lexeme matching the pattern *number* is similar, using the auxiliary function `installNumO`. •

### 3.5.3 Conflict Resolution in Lex

We have alluded to the two rules that Lex uses to decide on the proper lexeme to select, when several prefixes of the input match one or more patterns:

1. Always prefer a longer prefix to a shorter prefix.
2. If the longest possible prefix matches two or more patterns, prefer the pattern listed first in the Lex program.

Example 3.12: The first rule tells us to continue reading letters and digits to find the longest prefix of these characters to group as an identifier. It also tells us to treat `<=` as a single lexeme, rather than selecting `<` as one lexeme and `=` as the next lexeme. The second rule makes keywords reserved, if we list the keywords before `id` in the program. For instance, if `then` is determined to be the longest prefix of the input that matches any pattern, and the pattern `then` precedes `{id}`, as it does in Fig. 3.23, then the token `THEN` is returned, rather than `ID`. •

### 3.5.4 The Lookahead Operator

Lex automatically reads one character ahead of the last character that forms the selected lexeme, and then retracts the input so only the lexeme itself is consumed from the input. However, sometimes, we want a certain pattern to be matched to the input only when it is followed by a certain other characters. If so, we may use the slash in a pattern to indicate the end of the part of the

pattern that matches the lexeme. What follows / is additional pattern that must be matched before we can decide that the token in question was seen, but what matches this second pattern is not part of the lexeme.

Example 3.13: In Fortran and some other languages, keywords are not reserved. That situation creates problems, such as a statement

```
IF(I,J) = 3
```

where **IF** is the name of an array, not a keyword. This statement contrasts with statements of the form

```
IF( condition ) THEN ...
```

where **IF** is a keyword. Fortunately, we can be sure that the keyword **IF** is always followed by a left parenthesis, some text — the condition — that may contain parentheses, a right parenthesis and a letter. Thus, we could write a **Lex** rule for the keyword **IF** like:

```
IF / \( .* \) {letter}
```

This rule says that the pattern the lexeme matches is just the two letters **IF**. The slash says that additional pattern follows but does not match the lexeme. In this pattern, the first character is the left parentheses. Since that character is a **Lex** metasymbol, it must be preceded by a backslash to indicate that it has its literal meaning. The dot and star match "any string without a newline." Note that the dot is a **Lex** metasymbol meaning "any character except newline." It is followed by a right parenthesis, again with a backslash to give that character its literal meaning. The additional pattern is followed by the symbol *letter*, which is a regular definition representing the character class of all letters.

Note that in order for this pattern to be foolproof, we must preprocess the input to delete whitespace. We have in the pattern neither provision for whitespace, nor can we deal with the possibility that the condition extends over lines, since the dot will not match a newline character.

For instance, suppose this pattern is asked to match a prefix of input:

```
IF(A<(B+C)*D)THEN...
```

the first two characters match **IF**, the next character matches **(**, the next nine characters match **.\***, and the next two match **)** and *letter*. Note the fact that the first right parenthesis (after C) is not followed by a letter is irrelevant; we only need to find some way of matching the input to the pattern. We conclude that the letters **IF** constitute the lexeme, and they are an instance of token **if**.

•



### 3.5.5 Exercises for Section 3.5

**Exercise 3.5.1:** Describe how to make the following modifications to the **Lex** program of Fig. 3.23:

- a) Add the keyword **while**.
- b) Change the comparison operators to be the C operators of that kind.
- c) Allow the underscore (`_`) as an additional letter.
- ! d) Add a new pattern with token **STRING**. The pattern consists of a double-quote (`"`), any string of characters and a final double-quote. However, if a double-quote appears in the string, it must be escaped by preceding it with a backslash (`\`), and therefore a backslash in the string must be represented by two backslashes. The lexical value, which is the string without the surrounding double-quotes, and with backslashes used to escape a character removed. Strings are to be installed in a table of strings.

**Exercise 3.5.2:** Write a **Lex** program that copies a file, replacing each non-empty sequence of white space by a single blank.

**Exercise 3.5.3:** Write a **Lex** program that copies a C program, replacing each instance of the keyword **float** by **double**.

! **Exercise 3.5.4:** Write a **Lex** program that converts a file to "Pig latin." Specifically, assume the file is a sequence of words (groups of letters) separated by whitespace. Every time you encounter a word:

1. If the first letter is a consonant, move it to the end of the word and then add **ay**.
2. If the first letter is a vowel, just add **ay** to the end of the word.

All nonletters are copied intact to the output.

! **Exercise 3.5.5:** In SQL, keywords and identifiers are case-insensitive. Write a **Lex** program that recognizes the keywords **SELECT**, **FROM**, and **WHERE** (in any combination of capital and lower-case letters), and token **ID**, which for the purposes of this exercise you may take to be any sequence of letters and digits, beginning with a letter. You need not install identifiers in a symbol table, but tell how the "install" function would differ from that described for case-sensitive identifiers as in Fig. 3.23.

## 3.6 Finite Automata

We shall now discover how Lex turns its input program into a lexical analyzer. At the heart of the transition is the formalism known as *finite automata*. These are essentially graphs, like transition diagrams, with a few differences:

1. Finite automata are *recognizers*; they simply say "yes" or "no" about each possible input string.
2. Finite automata come in two flavors:
  - (a) *Nondeterministic finite automata* (NFA) have no restrictions on the labels of their edges. A symbol can label several edges out of the same state, and  $\epsilon$ , the empty string, is a possible label.
  - (b) *Deterministic finite automata* (DFA) have, for each state, and for each symbol of its input alphabet exactly one edge with that symbol leaving that state.

Both deterministic and nondeterministic finite automata are capable of recognizing the same languages. In fact these languages are exactly the same languages, called the *regular languages*, that regular expressions can describe.<sup>4</sup>

### 3.6.1 Nondeterministic Finite Automata

A *nondeterministic finite automaton* (NFA) consists of:

1. A finite set of states  $S$ .
2. A set of input symbols  $E$ , the *input alphabet*. We assume that  $\epsilon$ , which stands for the empty string, is never a member of  $E$ .
3. A *transition function* that gives, for each state, and for each symbol in  $E \cup \{\epsilon\}$  a set of *next states*.
4. A state  $s_0$  from  $S$  that is distinguished as the *start state* (or *initial state*).
5. A set of states  $F$ , a subset of  $S$ , that is distinguished as the *accepting states* (or *final states*).

We can represent either an NFA or DFA by a *transition graph*, where the nodes are states and the labeled edges represent the transition function. There is an edge labeled  $a$  from state  $s$  to state  $t$  if and only if  $t$  is one of the next states for state  $s$  and input  $a$ . This graph is very much like a transition diagram, except:

<sup>4</sup>There is a small lacuna: as we defined them, regular expressions cannot describe the empty language, since we would never want to use this pattern in practice. However, finite automata *can* define the empty language. In the theory,  $\emptyset$  is treated as an additional regular expression for the sole purpose of defining the empty language.

- a) The same symbol can label edges from one state to several different states, and
- b) An edge may be labeled by  $\epsilon$ , the empty string, instead of, or in addition to, symbols from the input alphabet.

Example 3.14: The transition graph for an NFA recognizing the language of regular expression  $(a|b)^*abb$  is shown in Fig. 3.24. This abstract example, describing all strings of a's and b's ending in the particular string  $abb$ , will be used throughout this section. It is similar to regular expressions that describe languages of real interest, however. For instance, an expression describing all files whose name ends in  $.o$  is  $\text{any}^*.o$ , where  $\text{any}$  stands for any printable character.

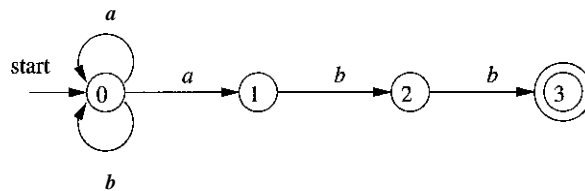

Figure 3.24: A nondeterministic finite automaton

Following our convention for transition diagrams, the double circle around state 3 indicates that this state is accepting. Notice that the only ways to get from the start state 0 to the accepting state is to follow some path that stays in state 0 for a while, then goes to states 1, 2, and 3 by reading  $abb$  from the input. Thus, the only strings getting to the accepting state are those that end in  $abb$ . •

### 3.6.2 Transition Tables

We can also represent an NFA by a *transition table*, whose rows correspond to states, and whose columns correspond to the input symbols and  $\epsilon$ . The entry for a given state and input is the value of the transition function applied to those arguments. If the transition function has no information about that state-input pair, we put 0 in the table for the pair.

Example 3.15: The transition table for the NFA of Fig. 3.24 is shown in Fig. 3.25. •

The transition table has the advantage that we can easily find the transitions on a given state and input. Its disadvantage is that it takes a lot of space, when the input alphabet is large, yet most states do not have any moves on most of the input symbols.

STATE	$a$	$b$	$e$
0	{0,1}	{0}	0
1	0	{2}	0
2	0	{3}	0
3	0	0	0

Figure 3.25: Transition table for the NFA of Fig. 3.24

### 3.6.3 Acceptance of Input Strings by Automata

An NFA *accepts* input string  $x$  if and only if there is some path in the transition graph from the start state to one of the accepting states, such that the symbols along the path spell out  $x$ . Note that  $e$  labels along the path are effectively ignored, since the empty string does not contribute to the string constructed along the path.

**Example 3.16:** The string  $aabb$  is accepted by the NFA of Fig. 3.24. The path labeled by  $aabb$  from state 0 to state 3 demonstrating this fact is:

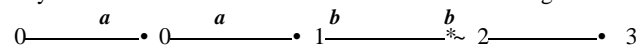

Note that several paths labeled by the same string may lead to different states. For instance, path

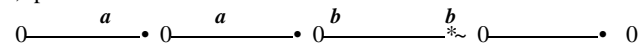

is another path from state 0 labeled by the string  $aabb$ . This path leads to state 0, which is not accepting. However, remember that an NFA accepts a string as long as *some* path labeled by that string leads from the start state to an accepting state. The existence of other paths leading to a nonaccepting state is irrelevant. •

The *language defined* (or *accepted*) by an NFA is the set of strings labeling some path from the start to an accepting state. As was mentioned, the NFA of Fig. 3.24 defines the same language as does the regular expression  $(a|b)^*abb$ , that is, all strings from the alphabet  $\{a, b\}$  that end in  $abb$ . We may use  $L(A)$  to stand for the language accepted by automaton  $A$ .

**Example 3.17:** Figure 3.26 is an NFA accepting  $L(aa^*|bb^*)$ . String  $aaa$  is accepted because of the path

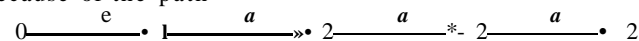

Note that  $e$ 's "disappear" in a concatenation, so the label of the path is  $aaa$ . •

### 3.6.4 Deterministic Finite Automata

A *deterministic finite automaton* (DFA) is a special case of an NFA where:

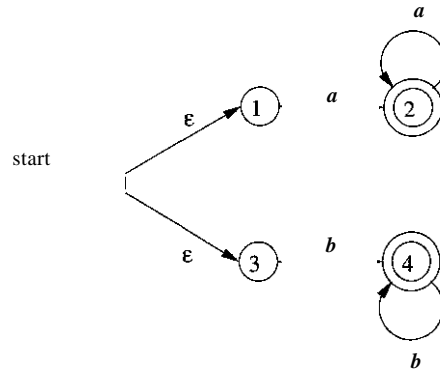
Figure 3.26: NFA accepting  $aa^*|bb^*$ 

1. There are no moves on input  $\epsilon$ , and
2. For each state  $s$  and input symbol  $a$ , there is exactly one edge out of  $s$  labeled  $a$ .

If we are using a transition table to represent a DFA, then each entry is a single state, we may therefore represent this state without the curly braces that we use to form sets.

While the NFA is an abstract representation of an algorithm to recognize the strings of a certain language, the DFA is a simple, concrete algorithm for recognizing strings. It is fortunate indeed that every regular expression and every NFA can be converted to a DFA accepting the same language, because it is the DFA that we really implement or simulate when building lexical analyzers. The following algorithm shows how to apply a DFA to a string.

**Algorithm 3.18:** Simulating a DFA.

**INPUT:** An input string  $x$  terminated by an end-of-file character **eof**. A DFA  $D$  with start state  $so$ , accepting states  $F$ , and transition function  $move$ .

**OUTPUT:** Answer "yes" if  $D$  accepts  $x$ ; "no" otherwise.

**METHOD:** Apply the algorithm in Fig. 3.27 to the input string  $x$ . The function  $move(s,c)$  gives the state to which there is an edge from state  $s$  on input  $c$ . The function  $next Char$  returns the next character of the input string  $x$ . •

**Example 3.19:** In Fig. 3.28 we see the transition graph of a DFA accepting the language  $(a|b)^*abb$ , the same as that accepted by the NFA of Fig. 3.24. Given the input string  $ababb$ , this DFA enters the sequence of states 0, 1, 2, 1, 2, 3 and returns "yes." •

```

s = S;
c = nextCharQ;
while ( c != eof ) {
    s = move(s,c);
    c = nextCharQ;
}
if ( s is in F ) return "yes";
else return "no";

```

Figure 3.27: Simulating a DFA

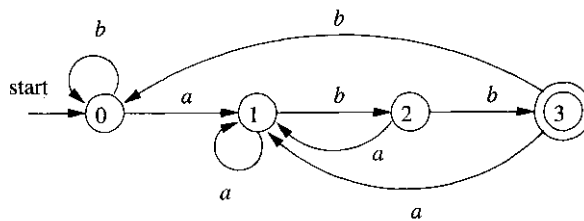
Figure 3.28: DFA accepting  $(a|b)^*abb$ 

### 3.6.5 Exercises for Section 3.6

**Exercise 3.6.1:** Figure 3.19 in the exercises of Section 3.4 computes the failure function for the KMP algorithm. Show how, given that failure function, we can construct, from a keyword  $b_1 b_2 \dots b_n$ , an  $n + 1$ -state DFA that recognizes  $*b_1 b_2 \dots b_n$ , where the dot stands for "any character." Moreover, this DFA can be constructed in  $O(n)$  time.

**Exercise 3.6.2:** Design finite automata (deterministic or nondeterministic) for each of the languages of Exercise 3.3.5.

**Exercise 3.6.3:** For the NFA of Fig. 3.29, indicate all the paths labeled  $aabb$ . Does the NFA accept  $aabb$ ?

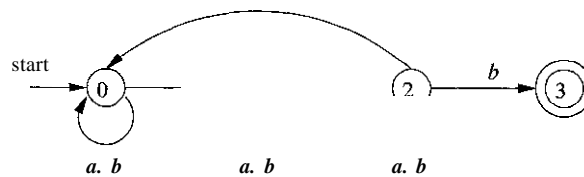

Figure 3.29: NFA for Exercise 3.6.3

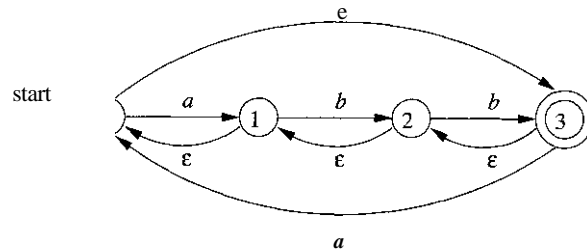

Figure 3.30: NFA for Exercise 3.6.4

Exercise 3.6.4: Repeat Exercise 3.6.3 for the NFA of Fig. 3.30.

Exercise 3.6.5: Give the transition tables for the NFA of:

- a) Exercise 3.6.3.
- b) Exercise 3.6.4.
- c) Figure 3.26.

## 3.7 From Regular Expressions to Automata

The regular expression is the notation of choice for describing lexical analyzers and other pattern-processing software, as was reflected in Section 3.5. However, implementation of that software requires the simulation of a DFA, as in Algorithm 3.18, or perhaps simulation of an NFA. Because an NFA often has a choice of move on an input symbol (as Fig. 3.24 does on input  $a$  from state 0) or on  $\epsilon$  (as Fig. 3.26 does from state 0), or even a choice of making a transition on  $\epsilon$  or on a real input symbol, its simulation is less straightforward than for a DFA. Thus often it is important to convert an NFA to a DFA that accepts the same language.

In this section we shall first show how to convert NFA's to DFA's. Then, we use this technique, known as "the subset construction," to give a useful algorithm for simulating NFA's directly, in situations (other than lexical analysis) where the NFA-to-DFA conversion takes more time than the direct simulation. Next, we show how to convert regular expressions to NFA's, from which a DFA can be constructed if desired. We conclude with a discussion of the time-space tradeoffs inherent in the various methods for implementing regular expressions, and see how to choose the appropriate method for your application.

### 3.7.1 Conversion of an NFA to a DFA

The general idea behind the subset construction is that each state of the constructed DFA corresponds to a set of NFA states. After reading input

flifl2  $\dots Q > n$ , the DFA is in that state which corresponds to the set of states that the NFA can reach, from its start state, following paths labeled  $a \setminus a_1 \dots a_n$ .

It is possible that the number of DFA states is exponential in the number of NFA states, which could lead to difficulties when we try to implement this DFA. However, part of the power of the automaton-based approach to lexical analysis is that for real languages, the NFA and DFA have approximately the same number of states, and the exponential behavior is not seen.

Algorithm 3.20: The *subset construction* of a DFA from an NFA.

**INPUT:** An NFA  $N$ .

**OUTPUT:** A DFA  $D$  accepting the same language as  $N$ .

**METHOD:** Our algorithm constructs a transition table  $Dtran$  for  $D$ . Each state of  $D$  is a set of NFA states, and we construct  $Dtran$  so  $D$  will simulate "in parallel" all possible moves  $N$  can make on a given input string. Our first problem is to deal with e-transitions of  $N$  properly. In Fig. 3.31 we see the definitions of several functions that describe basic computations on the states of  $N$  that are needed in the algorithm. Note that  $s$  is a single state of  $N$ , while  $T$  is a set of states of  $N$ .

OPERATION	DESCRIPTION
$e\text{-closure}(s)$	Set of NFA states reachable from NFA state $s$ on e-transitions alone.
$e\text{-closure}(T)$	Set of NFA states reachable from some NFA state $s$ in set $T$ on e-transitions alone; $= \cup_{s \in T} e\text{-closure}(s)$ .
$move(T, a)$	Set of NFA states to which there is a transition on input symbol $a$ from some state $s$ in $T$ .

Figure 3.31: Operations on NFA states

We must explore those sets of states that  $N$  can be in after seeing some input string. As a basis, before reading the first input symbol,  $N$  can be in any of the states of  $e\text{-closure}(s_0)$ , where  $s_0$  is its start state. For the induction, suppose that  $N$  can be in set of states  $T$  after reading input string  $x$ . If it next reads input  $a$ , then  $N$  can immediately go to any of the states in  $move(T, a)$ . However, after reading  $a$ , it may also make several e-transitions; thus  $N$  could be in any state of  $e\text{-closure}(move(T, a))$  after reading input  $xa$ . Following these ideas, the construction of the set of  $D$ 's states,  $Dstates$ , and its transition function  $Dtran$ , is shown in Fig. 3.32.

The start state of  $D$  is  $e\text{-closure}(s_0)$ , and the accepting states of  $D$  are all those sets of  $D$ 's states that include at least one accepting state of  $N$ . To complete our description of the subset construction, we need only to show how



```

initially,  $e\text{-closure}(s_0)$  is the only state in  $Dstates$ , and it is unmarked;
while ( there is an unmarked state  $T$  in  $Dstates$  ) {
    mark  $T$ ;
    for ( each input symbol  $a$  ) {
         $U = e\text{-closure}(\text{move}(T,a))$ ;
        if (  $U$  is not in  $Dstates$  )
            add  $U$  as an unmarked state to  $Dstates$ ;
         $Dtran[T, a] = U$ ;
    }
}

```

Figure 3.32: The subset construction

$e\text{-closure}(T)$  is computed for any set of NFA states  $T$ . This process, shown in Fig. 3.33, is a straightforward search in a graph from a set of states. In this case, imagine that only the  $e$ -labeled edges are available in the graph. •

```

push all states of  $T$  onto  $stack$ ;
initialize  $e\text{-closure}(T)$  to  $T$ ;
while (  $stack$  is not empty ) {
    pop  $t$ , the top element, off  $stack$ ;
    for ( each state  $u$  with an edge from  $t$  to  $u$  labeled  $e$  )
        if (  $u$  is not in  $e\text{-closure}(T)$  ) {
            add  $u$  to  $e\text{-closure}(T)$ ;
            push  $u$  onto  $stack$ ;
        }
}

```

Figure 3.33: Computing  $e\text{-closure}(T)$ 

**Example 3.21:** Figure 3.34 shows another NFA accepting  $(a|b)^*abb$ ; it happens to be the one we shall construct directly from this regular expression in Section 3.7. Let us apply Algorithm 3.20 to Fig. 3.29.

The start state  $A$  of the equivalent DFA is  $e\text{-closure}(0)$ , or  $A = \{0,1,2,4,7\}$ , since these are exactly the states reachable from state 0 via a path all of whose edges have label  $e$ . Note that a path can have zero edges, so state 0 is reachable from itself by an  $e$ -labeled path.

The input alphabet is  $\{a, b\}$ . Thus, our first step is to mark  $A$  and compute  $Dtran[A,a] = e\text{-closure}(\text{move}(A,a))$  and  $Dtran[A,b] = e\text{-closure}(\text{move}(A,b))$ . Among the states 0, 1, 2, 4, and 7, only 2 and 7 have transitions on  $a$ , to 3 and 8, respectively. Thus,  $\text{move}(A,a) = \{3,8\}$ . Also,  $e\text{-closure}(\{3,8\}) = \{1,2,3,4,6,7,8\}$ , so we conclude

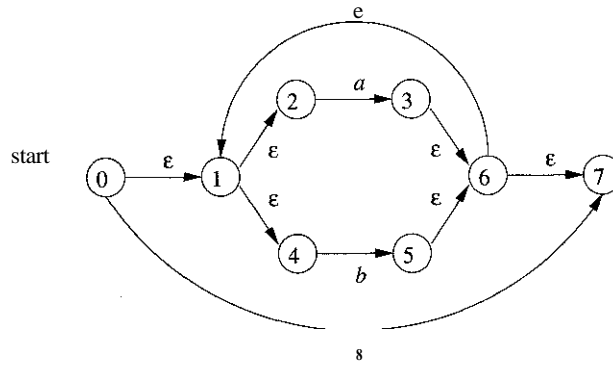

Figure 3.34: NFA  $N$  for  $(a|b)^*abb$

$$Dtran[A,a] = e-closure(move(A,a)) = e-closure(\{3,8\}) = \{1, 2, 3, 4, 6, 7, 8\}$$

Let us call this set  $B$ , so  $Dtran[A, a] = B$ .

Now, we must compute  $Dtran[A,b]$ . Among the states in  $A$ , only 4 has a transition on 6, and it goes to 5. Thus,

$$Dtran[A,b] = e-closure(\{5\}) = \{1, 2, 4, 6, 7\}$$

Let us call the above set  $C$ , so  $Dtran[A, b] = C$ .

NFA STATE	DFA STATE	$a$	$b$
$\{0, 1, 2, 4, 7\}$	$A$	$B$	$C$
$\{1, 2, 3, 4, 6, 7, 8\}$	$B$	$B$	$D$
$\{1, 2, 4, 5, 6, 7\}$	$C$	$B$	$C$
$\{1, 2, 4, 5, 6, 7, 9\}$	$D$	$B$	$E$
$\{1, 2, 3, 5, 6, 7, 10\}$	$E$	$B$	$C$

Figure 3.35: Transition table  $Dtran$  for DFA  $D$

If we continue this process with the unmarked sets  $B$  and  $C$ , we eventually reach a point where all the states of the DFA are marked. This conclusion is guaranteed, since there are "only"  $2^{11}$  different subsets of a set of eleven NFA states. The five different DFA states we actually construct, their corresponding sets of NFA states, and the transition table for the DFA  $D$  are shown in Fig. 3.35, and the transition graph for  $D$  is in Fig. 3.36. State  $A$  is the start state, and state  $E$ , which contains state 10 of the NFA, is the only accepting state.

Note that  $D$  has one more state than the DFA of Fig. 3.28 for the same language. States  $A$  and  $C$  have the same move function, and so can be merged. We discuss the matter of minimizing the number of states of a DFA in Section 3.9.6.

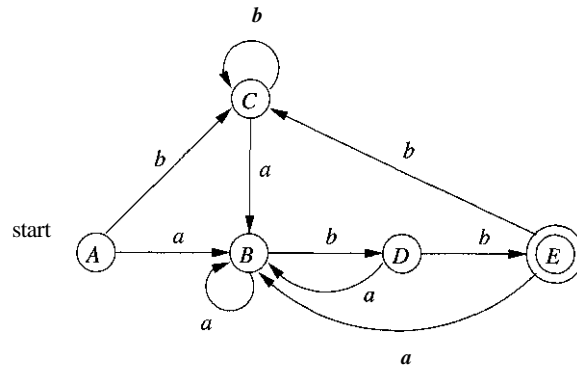

Figure 3.36: Result of applying the subset construction to Fig. 3.34

### 3.7.2 Simulation of an NFA

A strategy that has been used in a number of text-editing programs is to construct an NFA from a regular expression and then simulate the NFA using something like an on-the-fly subset construction. The simulation is outlined below.

**Algorithm 3.22:** Simulating an NFA.

**INPUT:** An input string  $x$  terminated by an end-of-file character **eof**. An NFA  $N$  with start state  $SQ$ , accepting states  $F$ , and transition function  $move$ .

**OUTPUT:** Answer "yes" if  $M$  accepts  $x$ ; "no" otherwise.

**METHOD:** The algorithm keeps a set of current states  $S$ , those that are reached from  $so$  following a path labeled by the inputs read so far. If  $c$  is the next input character, read by the function  $nextCharQ$ , then we first compute  $move(S,c)$  and then close that set using  $e-closureQ$ . The algorithm is sketched in Fig. 3.37.

•

```

1)  $S = e-closure(so);$ 
2)  $c = nextCharQ;$ 
3) while (  $c \neq eof$  ) {
4)      $S = e-closure(move(S,c));$ 
5)      $c = nextCharQ;$ 
6) }
7) if (  $S \cap F \neq \emptyset$  ) return "yes";
8) else return "no";

```

Figure 3.37: Simulating an NFA

### 3.7.3 Efficiency of NFA Simulation

If carefully implemented, Algorithm 3.22 can be quite efficient. As the ideas involved are useful in a number of similar algorithms involving search of graphs, we shall look at this implementation in additional detail. The data structures we need are:

1. Two stacks, each of which holds a set of NFA states. One of these stacks, *oldStates*, holds the "current" set of states, i.e., the value of  $S$  on the right side of line (4) in Fig. 3.37. The second, *newStates*, holds the "next" set of states —  $S$  on the left side of line (4). Unseen is a step where, as we go around the loop of lines (3) through (6), *newStates* is transferred to *oldStates*.
2. A boolean array *alreadyOn*, indexed by the NFA states, to indicate which states are in *newStates*. While the array and stack hold the same information, it is much faster to interrogate *alreadyOn[s]* than to search for state  $s$  on the stack *newStates*. It is for this efficiency that we maintain both representations.
3. A two-dimensional array *move[s,a]* holding the transition table of the NFA. The entries in this table, which are sets of states, are represented by linked lists.

To implement line (1) of Fig. 3.37, we need to set each entry in array *alreadyOn* to **FALSE**, then for each state  $s$  in *e-closure(so)*, push  $s$  onto *oldStates* and set *alreadyOn[s]* to **TRUE**. This operation on state  $s$ , and the implementation of line (4) as well, are facilitated by a function we shall call *addState(s)*. This function pushes state  $s$  onto *newStates*, sets *alreadyOn[s]* to **TRUE**, and calls itself recursively on the states in *move[s,e]* in order to further the computation of *e-closure(s)*. However, to avoid duplicating work, we must be careful never to call *addState* on a state that is already on the stack *newStates*. Figure 3.38 sketches this function.

```

9)  addState(s) {
10)     push s onto newStates;
11)     alreadyOn[s] = TRUE;
12)     for ( t on move[s, e] )
13)         if ( !alreadyOn(t) )
14)             addState(t);
15) }
```

Figure 3.38: Adding a new state  $s$ , which is known not to be on *newStates*

We implement line (4) of Fig. 3.37 by looking at each state  $s$  on *oldStates*. We first find the set of states *move[s, c]*, where  $c$  is the next input, and for each

of those states that is not already on *newStates*, we apply *addState* to it. Note that *addState* has the effect of computing the *e-closure* and adding all those states to *newStates* as well, if they were not already on. This sequence of steps is summarized in Fig. 3.39.

```

16)  for ( s on oldStates ) {
17)      for ( t on move[s, c] )
18)          if ( !alreadyOn[t] )
19)              addState(t);
20)      pop s from oldStates;
21)  }

22)  for ( s on newStates ) {
23)      pop s from newStates;
24)      push s onto oldStates;
25)      a/readyOn[s] = FALSE;
26)  }
```

Figure 3.39: Implementation of step (4) of Fig. 3.37

Now, suppose that the NFA  $N$  has  $n$  states and  $m$  transitions; i.e.,  $m$  is the sum over all states of the number of symbols (or  $e$ ) on which the state has a transition out. Not counting the call to *addState* at line (19) of Fig. 3.39, the time spent in the loop of lines (16) through (21) is  $O(n)$ . That is, we can go around the loop at most  $n$  times, and each step of the loop requires constant work, except for the time spent in *addState*. The same is true of the loop of lines (22) through (26).

During one execution of Fig. 3.39, i.e., of step (4) of Fig. 3.37, it is only possible to call *addState* on a given state once. The reason is that whenever we call *addState(s)*, we set *alreadyOn[s]* to TRUE at line (11) of Fig. 3.39. Once *alreadyOn[s]* is TRUE, the tests at line (13) of Fig. 3.38 and line (18) of Fig. 3.39 prevent another call.

The time spent in one call to *addState*, exclusive of the time spent in recursive calls at line (14), is  $O(1)$  for lines (10) and (11). For lines (12) and (13), the time depends on how many  $e$ -transitions there are out of state  $s$ . We do not know this number for a given state, but we know that there are at most  $m$  transitions in total, out of all states. As a result, the aggregate time spent in lines (11) over all calls to *addState* during one execution of the code of Fig. 3.39 is  $O(m)$ . The aggregate for the rest of the steps of *addState* is  $O(n)$ , since it is a constant per call, and there are at most  $n$  calls.

We conclude that, implemented properly, the time to execute line (4) of Fig. 3.37 is  $O(n + m)$ . The rest of the while-loop of lines (3) through (6) takes  $O(1)$  time per iteration. If the input  $x$  is of length  $k$ , then the total work in that loop is  $O(k(n + m))$ . Line (1) of Fig. 3.37 can be executed in  $O(n + m)$  time, since it is essentially the steps of Fig. 3.39 with *oldStates* containing only

### Big-Oh Notation

An expression like  $O(n)$  is a shorthand for "at most some constant times  $n$ ." Technically, we say a function  $f(n)$ , perhaps the running time of some step of an algorithm, is  $O(g(n))$  if there are constants  $c$  and  $n_0$ , such that whenever  $n > n_0$ , it is true that  $f(n) < cg(n)$ . A useful idiom is " $O(1)$ ," which means "some constant." The use of this *big-oh notation* enables us to avoid getting too far into the details of what we count as a unit of execution time, yet lets us express the rate at which the running time of an algorithm grows.

the state so- Lines (2), (7), and (8) each take  $O(1)$  time. Thus, the running time of Algorithm 3.22, properly implemented, is  $O(k(n + m))$ . That is, the time taken is proportional to the length of the input times the size (nodes plus edges) of the transition graph.

#### 3.7.4 Construction of an NFA from a Regular Expression

We now give an algorithm for converting any regular expression to an NFA that defines the same language. The algorithm is syntax-directed, in the sense that it works recursively up the parse tree for the regular expression. For each subexpression the algorithm constructs an NFA with a single accepting state.

Algorithm 3.23: The McNaughton-Yamada-Thompson algorithm to convert a regular expression to an NFA.

**INPUT:** A regular expression  $r$  over alphabet  $S$ .

**OUTPUT:** An NFA  $N$  accepting  $L(r)$ .

**METHOD:** Begin by parsing  $r$  into its constituent subexpressions. The rules for constructing an NFA consist of basis rules for handling subexpressions with no operators, and inductive rules for constructing larger NFA's from the NFA's for the immediate subexpressions of a given expression.

**BASIS:** For expression  $e$  construct the NFA

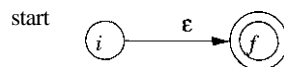

Here,  $i$  is a new state, the start state of this NFA, and  $f$  is another new state, the accepting state for the NFA.

For any subexpression  $a$  in  $S$ , construct the NFA

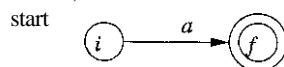

where again  $i$  and  $/$  are new states, the start and accepting states, respectively. Note that in both of the basis constructions, we construct a distinct NFA, with new states, for every occurrence of  $e$  or some  $o$  as a subexpression of  $r$ .

**INDUCTION:** Suppose  $N(s)$  and  $N(t)$  are NFA's for regular expressions  $s$  and  $t$ , respectively.

- a) Suppose  $r = s|t$ . Then  $N(r)$ , the NFA for  $r$ , is constructed as in Fig. 3.40. Here,  $i$  and  $/$  are new states, the start and accepting states of  $N(r)$ , respectively. There are  $\epsilon$ -transitions from  $i$  to the start states of  $N(s)$  and  $N(t)$ , and each of their accepting states have  $\epsilon$ -transitions to the accepting state  $/$ . Note that the accepting states of  $N(s)$  and  $N(t)$  are not accepting in  $N(r)$ . Since any path from  $i$  to  $/$  must pass through either  $N(s)$  or  $N(t)$  exclusively, and since the label of that path is not changed by the  $\epsilon$ 's leaving  $i$  or entering  $/$ , we conclude that  $N(r)$  accepts  $L(s) \cup L(t)$ , which is the same as  $L(r)$ . That is, Fig. 3.40 is a correct construction for the union operator.

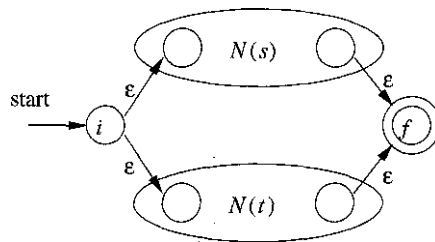

Figure 3.40: NFA for the union of two regular expressions

- b) Suppose  $r = st$ . Then construct  $N(r)$  as in Fig. 3.41. The start state of  $N(s)$  becomes the start state of  $N(r)$ , and the accepting state of  $N(t)$  is the only accepting state of  $N(r)$ . The accepting state of  $N(s)$  and the start state of  $N(t)$  are merged into a single state, with all the transitions in or out of either state. A path from  $i$  to  $/$  in Fig. 3.41 must go first through  $N(s)$ , and therefore its label will begin with some string in  $L(s)$ . The path then continues through  $N(t)$ , so the path's label finishes with a string in  $L(t)$ . As we shall soon argue, accepting states never have edges out and start states never have edges in, so it is not possible for a path to re-enter  $N(s)$  after leaving it. Thus,  $N(r)$  accepts exactly  $L(s)L(t)$ , and is a correct NFA for  $r = st$ .

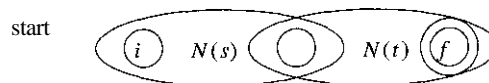

Figure 3.41: NFA for the concatenation of two regular expressions

- c) Suppose  $r = s^*$ . Then for  $r$  we construct the NFA  $N(r)$  shown in Fig. 3.42. Here,  $i$  and  $f$  are new states, the start state and lone accepting state of  $N(r)$ . To get from  $i$  to  $f$ , we can either follow the introduced path labeled  $e$ , which takes care of the one string in  $L(s)^\circ$ , or we can go to the start state of  $N(s)$ , through that NFA, then from its accepting state back to its start state zero or more times. These options allow  $N(r)$  to accept all the strings in  $L(s)$ ,  $L(s)^2$ , and so on, so the entire set of strings accepted by  $N(r)$  is  $L(s^*)$ .

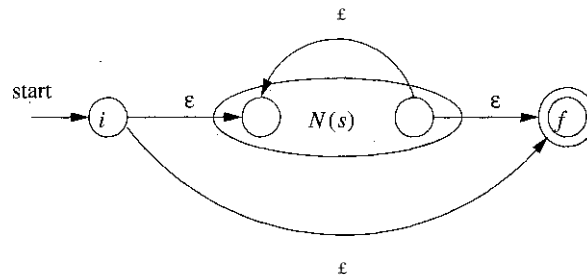

Figure 3.42: NFA for the closure of a regular expression

- d) Finally, suppose  $r = (s)$ . Then  $L(r) = L(s)$ , and we can use the NFA  $N(s)$  as  $N(r)$ .

•

The method description in Algorithm 3.23 contains hints as to why the inductive construction works as it should. We shall not give a formal correctness proof, but we shall list several properties of the constructed NFA's, in addition to the all-important fact that  $N(r)$  accepts language  $L(r)$ . These properties are interesting in their own right, and helpful in making a formal proof.

1.  $N(r)$  has at most twice as many states as there are operators and operands in  $r$ . This bound follows from the fact that each step of the algorithm creates at most two new states.
2.  $N(r)$  has one start state and one accepting state. The accepting state has no outgoing transitions, and the start state has no incoming transitions.
3. Each state of  $N(r)$  other than the accepting state has either one outgoing transition on a symbol in  $E$  or two outgoing transitions, both on  $e$ .

Example 3.24: Let us use Algorithm 3.23 to construct an NFA for  $r = (a|b)^*abb$ . Figure 3.43 shows a parse tree for  $r$  that is analogous to the parse trees constructed for arithmetic expressions in Section 2.2.3. For subexpression  $ri$ , the first  $a$ , we construct the NFA:



Figure 3.43: Parse tree for  $(\mathbf{a|b})^*\mathbf{abb}$

start

State numbers have been chosen for consistency with what follows. For  $r_1$  we construct:

start  
 $\bullet \odot -$

We can now combine  $JV(n)$  and  $N(r_1)$ , using the construction of Fig. 3.40 to obtain the NFA for  $r_1 = r_1 \setminus r_1$  this NFA is shown in Fig. 3.44.

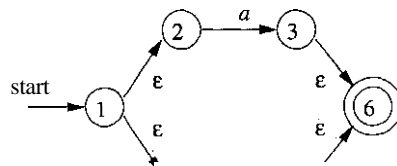

Figure 3.44: NFA for  $r_1$

The NFA for  $r_1 = (73)$  is the same as that for 7-3. The NFA for  $r_1 = (r_1)^*$  is then as shown in Fig. 3.45. We have used the construction in Fig. 3.42 to build this NFA from the NFA in Fig. 3.44.

Now, consider subexpression  $r_1^{\$}$ , which is another  $\mathbf{a}$ . We use the basis construction for  $a$  again, but we must use new states. It is not permissible to reuse

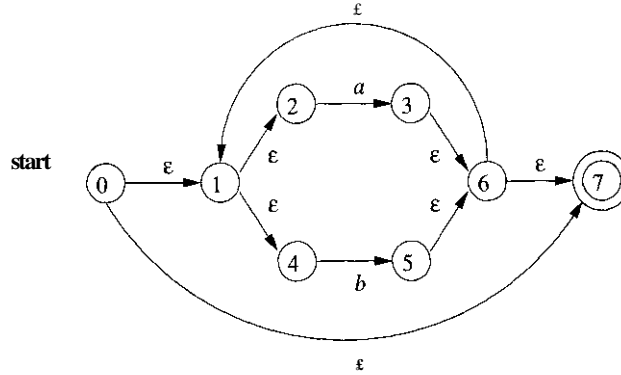
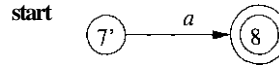

Figure 3.45: NFA for  $r_1$

the NFA we constructed for  $r_1$ , even though  $r_1$  and  $r_1\%$  are the same expression. The NFA for  $r_1\%$  is:



To obtain the NFA for  $rr = r_1r_1\%$ , we apply the construction of Fig. 3.41. We merge states 7 and 7', yielding the NFA of Fig. 3.46. Continuing in this fashion with new NFA's for the two subexpressions  $\mathbf{b}$  called  $rg$  and  $rio$ , we eventually construct the NFA for  $(\mathbf{a|b})^*\mathbf{abb}$  that we first met in Fig. 3.34. •

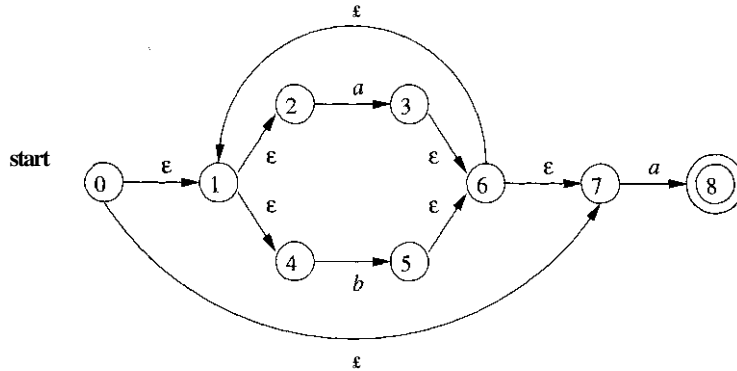

Figure 3.46: NFA for  $rr$

### 3.7.5 Efficiency of String-Processing Algorithms

We observed that Algorithm 3.18 processes a string  $x$  in time  $\mathbf{O}(|x|)$ , while in Section 3.7.3 we concluded that we could simulate an NFA in time proportional to the product of  $|x|$  and the size of the NFA's transition graph. Obviously, it

is faster to have a DFA to simulate than an NFA, so we might wonder whether it ever makes sense to simulate an NFA.

One issue that may favor an NFA is that the subset construction can, in the worst case, exponentiate the number of states. While in principle, the number of DFA states does not influence the running time of Algorithm 3.18, should the number of states become so large that the transition table does not fit in main memory, then the true running time would have to include disk I/O and therefore rise noticeably.

**Example 3.25:** Consider the family of languages described by regular expressions of the form  $L_n = (\mathbf{a|b})^* \mathbf{a(a|b)^{n-1}}$ , that is, each language  $L_n$  consists of strings of a's and b's such that the  $n$ th character to the left of the right end holds  $a$ . An  $n + 1$ -state NFA is easy to construct. It stays in its initial state under any input, but also has the option, on input  $a$ , of going to state 1. From state 1, it goes to state 2 on any input, and so on, until in state  $n$  it accepts. Figure 3.47 suggests this NFA.

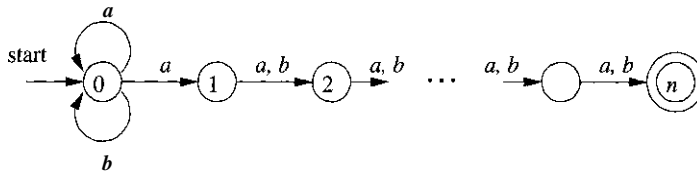

Figure 3.47: An NFA that has many fewer states than the smallest equivalent DFA

However, any DFA for the language  $L_n$  must have at least  $2^n$  states. We shall not prove this fact, but the idea is that if two strings of length  $n$  can get the DFA to the same state, then we can exploit the last position where the strings differ (and therefore one must have  $a$ , the other  $b$ ) to continue the strings identically, until they are the same in the last  $n - 1$  positions. The DFA will then be in a state where it must both accept and not accept. Fortunately, as we mentioned, it is rare for lexical analysis to involve patterns of this type, and we do not expect to encounter DFA's with outlandish numbers of states in practice. •

However, lexical-analyzer generators and other string-processing systems often start with a regular expression. We are faced with a choice of converting the regular expression to an NFA or DFA. The additional cost of going to a DFA is thus the cost of executing Algorithm 3.23 on the NFA (one could go directly from a regular expression to a DFA, but the work is essentially the same). If the string-processor is one that will be executed many times, as is the case for lexical analysis, then any cost of converting to a DFA is worthwhile. However, in other string-processing applications, such as **grep**, where the user specifies one regular expression and one or several files to be searched for the pattern

of that expression, it may be more efficient to skip the step of constructing a DFA, and simulate the NFA directly.

Let us consider the cost of converting a regular expression  $r$  to an NFA by Algorithm 3.23. A key step is constructing the parse tree for  $r$ . In Chapter 4 we shall see several methods that are capable of constructing this parse tree in linear time, that is, in time  $O(|r|)$ , where  $|r|$  stands for the *size* of  $r$  — the sum of the number of operators and operands in  $r$ . It is also easy to check that each of the basis and inductive constructions of Algorithm 3.23 takes constant time, so the entire time spent by the conversion to an NFA is  $O(|r|)$ .

Moreover, as we observed in Section 3.7.4, the NFA we construct has at most  $|r|$  states and at most  $2|r|$  transitions. That is, in terms of the analysis in Section 3.7.3, we have  $n < |r|$  and  $m < 2|r|$ . Thus, simulating this NFA on an input string  $x$  takes time  $O(|r| \times |x|)$ . This time dominates the time taken by the NFA construction, which is  $O(|r|)$ , and therefore, we conclude that it is possible to take a regular expression  $r$  and string  $x$ , and tell whether  $x$  is in  $L(r)$  in time  $O(|r| \times |x|)$ .

The time taken by the subset construction is highly dependent on the number of states the resulting DFA has. To begin, notice that in the subset construction of Fig. 3.32, the key step, the construction of a set of states  $U$  from a set of states  $T$  and an input symbol  $a$ , is very much like the construction of a new set of states from the old set of states in the NFA simulation of Algorithm 3.22. We already concluded that, properly implemented, this step takes time at most proportional to the number of states and transitions of the NFA.

Suppose we start with a regular expression  $r$  and convert it to an NFA. This NFA has at most  $|r|$  states and at most  $2|r|$  transitions. Moreover, there are at most  $|r|$  input symbols. Thus, for every DFA state constructed, we must construct at most  $|r|$  new states, and each one takes at most  $O(|r| + 2|r|)$  time. The time to construct a DFA of  $s$  states is thus  $O(|r|^2s)$ .

In the common case where  $s$  is about  $|r|$ , the subset construction takes time  $O(|r|^3)$ . However, in the worst case, as in Example 3.25, this time is  $O(|r|^2n)$ . Figure 3.48 summarizes the options when one is given a regular expression  $r$  and wants to produce a recognizer that will tell whether one or more strings  $x$  are in  $L(r)$ .

AUTOMATON	INITIAL	PER STRING
NFA	$O( r )$	$O( r  \times  x )$
DFA typical case	$O( r ^2)$	$O( s )$
DFA worst case	$O( r ^2n)$	$O( s )$

Figure 3.48: Initial cost and per-string-cost of various methods of recognizing the language of a regular expression

If the per-string cost dominates, as it does when we build a lexical analyzer,

we clearly prefer the DFA. However, in commands like `grep`, where we run the automaton on only one string, we generally prefer the NFA. It is not until  $|x|$  approaches  $|r|^3$  that we would even think about converting to a DFA.

There is, however, a mixed strategy that is about as good as the better of the NFA and the DFA strategy for each expression  $r$  and string  $x$ . Start off simulating the NFA, but remember the sets of NFA states (i.e., the DFA states) and their transitions, as we compute them. Before processing the current set of NFA states and the current input symbol, check to see whether we have already computed this transition, and use the information if so.

### 3.7.6 Exercises for Section 3.7

**Exercise 3.7.1:** Convert to DFA's the NFA's of:

- a) Fig. 3.26.
- b) Fig. 3.29.
- c) Fig. 3.30.

**Exercise 3.7.2:** use Algorithm 3.22 to simulate the NFA's:

- a) Fig. 3.29.
- b) Fig. 3.30.

on input *aabb*.

**Exercise 3.7.3:** Convert the following regular expressions to deterministic finite automata, using algorithms 3.23 and 3.20:

- a)  $(a|b)^*$ .
- b)  $(a^*|b^*)^*$ .
- c)  $((e|a)b^*)^*$ .
- d)  $(a|b)^*abb(a|b)^*$ .

## 3.8 Design of a Lexical-Analyzer Generator

In this section we shall apply the techniques presented in Section 3.7 to see how a lexical-analyzer generator such as `Lex` is architected. We discuss two approaches, based on NFA's and DFA's; the latter is essentially the implementation of `Lex`.

### 3.8.1 The Structure of the Generated Analyzer

Figure 3.49 Overviews the architecture of a lexical analyzer generated by Lex. The program that serves as the lexical analyzer includes a fixed program that simulates an automaton; at this point we leave open whether that automaton is deterministic or nondeterministic. The rest of the lexical analyzer consists of components that are created from the Lex program by Lex itself.

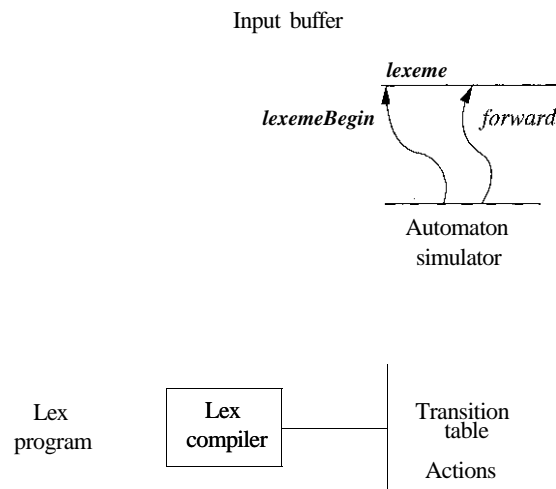

Figure 3.49: A Lex program is turned into a transition table and actions, which are used by a finite-automaton simulator

These components are:

1. A transition table for the automaton.
2. Those functions that are passed directly through Lex to the output (see Section 3.5.2).
3. The actions from the input program, which appear as fragments of code to be invoked at the appropriate time by the automaton simulator.

To construct the automaton, we begin by taking each regular-expression pattern in the Lex program and converting it, using Algorithm 3.23, to an NFA. We need a single automaton that will recognize lexemes matching any of the patterns in the program, so we combine all the NFA's into one by introducing a new start state with  $\epsilon$ -transitions to each of the start states of the NFA's  $N_i$  for pattern  $p_i$ . This construction is shown in Fig. 3.50.

Example 3.26: We shall illustrate the ideas of this section with the following simple, abstract example:

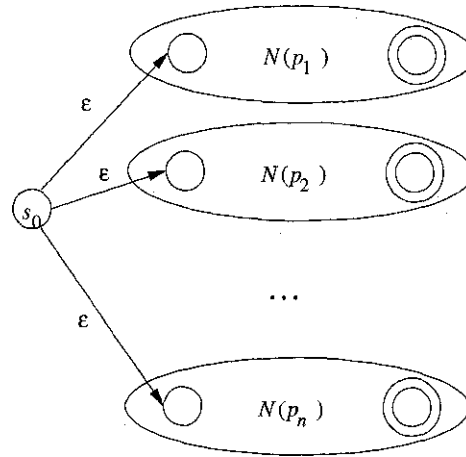
Figure 3.50: An NFA constructed from a **Lex** program

<b>a</b>	{ action $A_1$ for pattern $p_1$ }
<b>abb</b>	{ action $A_2$ for pattern $p_2$ }
<b>a*b</b>	{ action $A_n$ for pattern $p_n$ }

Note that these three patterns present some conflicts of the type discussed in Section 3.5.3. In particular, string *abb* matches both the second and third patterns, but we shall consider it a lexeme for pattern  $p_2$ , since that pattern is listed first in the above **Lex** program. Then, input strings such as *aabbb...* have many prefixes that match the third pattern. The **Lex** rule is to take the longest, so we continue reading *b*'s, until another *a* is met, whereupon we report the lexeme to be the initial *a*'s followed by as many *b*'s as there are.

Figure 3.51 shows three NFA's that recognize the three patterns. The third is a simplification of what would come out of Algorithm 3.23. Then, Fig. 3.52 shows these three NFA's combined into a single NFA by the addition of start state 0 and three  $\epsilon$ -transitions. •

### 3.8.2 Pattern Matching Based on NFA's

If the lexical analyzer simulates an NFA such as that of Fig. 3.52, then it must read input beginning at the point on its input which we have referred to as *lexemeBegin*. As it moves the pointer called *forward* ahead in the input, it calculates the set of states it is in at each point, following Algorithm 3.22.

Eventually, the NFA simulation reaches a point on the input where there are no next states. At that point, there is no hope that any longer prefix of the input would ever get the NFA to an accepting state; rather, the set of states will always be empty. Thus, we are ready to decide on the longest prefix that is a lexeme matching some pattern.

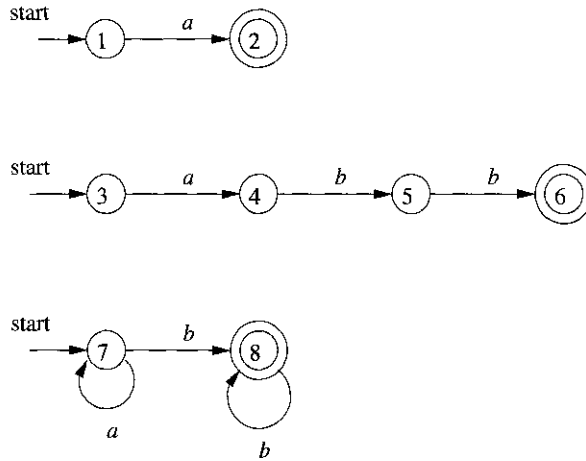

Figure 3.51: NFA's for **a**, **abb**, and **a\*b<sup>+</sup>**

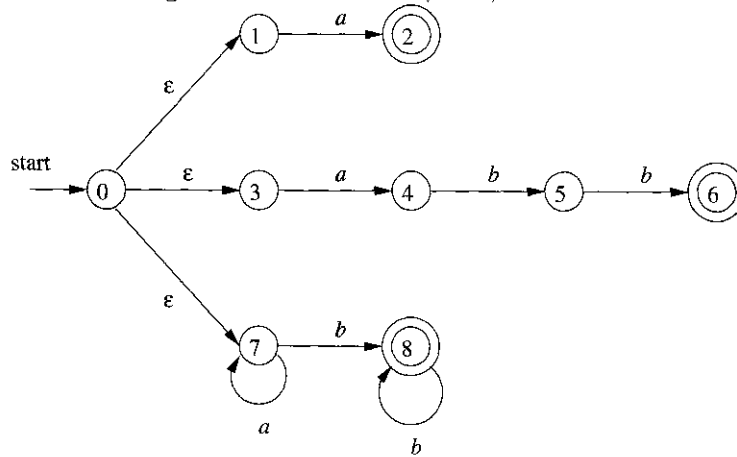

Figure 3.52: Combined NFA

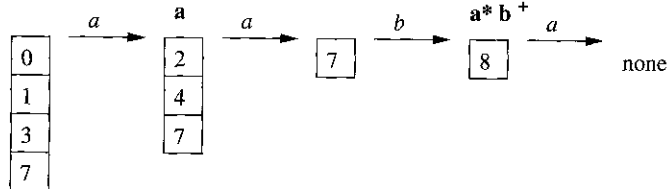

Figure 3.53: Sequence of sets of states entered when processing input **aaba**



We look backwards in the sequence of sets of states, until we find a set that includes one or more accepting states. If there are several accepting states in that set, pick the one associated with the earliest pattern  $p_i$  in the list from the **Lex** program. Move the *forward* pointer back to the end of the lexeme, and perform the action  $A_i$  associated with pattern  $p_i$ .

**Example 3.27:** Suppose we have the patterns of Example 3.26 and the input begins *aba*. Figure 3.53 shows the sets of states of the NFA of Fig. 3.52 that we enter, starting with *e-closure* of the initial state 0, which is  $\{0,1,3,7\}$ , and proceeding from there. After reading the fourth input symbol, we are in an empty set of states, since in Fig. 3.52, there are no transitions out of state 8 on input *a*.

Thus, we need to back up, looking for a set of states that includes an accepting state. Notice that, as indicated in Fig. 3.53, after reading *a* we are in a set that includes state 2 and therefore indicates that the pattern **a** has been matched. However, after reading *aab*, we are in state 8, which indicates that **a\*b** has been matched; prefix *aab* is the longest prefix that gets us to an accepting state. We therefore select *aab* as the lexeme, and execute action  $A_3$ , which should include a return to the parser indicating that the token whose pattern is  $p_3 = \mathbf{a*b}$  has been found. •

### 3.8.3 DFA's for Lexical Analyzers

Another architecture, resembling the output of **Lex**, is to convert the NFA for all the patterns into an equivalent DFA, using the subset construction of Algorithm 3.20. Within each DFA state, if there are one or more accepting NFA states, determine the first pattern whose accepting state is represented, and make that pattern the output of the DFA state.

**Example 3.28:** Figure 3.54 shows a transition diagram based on the DFA that is constructed by the subset construction from the NFA in Fig. 3.52. The accepting states are labeled by the pattern that is identified by that state. For instance, the state  $\{6,8\}$  has two accepting states, corresponding to patterns **abb** and **a\*b**. Since the former is listed first, that is the pattern associated with state  $\{6,8\}$ . •

We use the DFA in a lexical analyzer much as we did the NFA. We simulate the DFA until at some point there is no next state (or strictly speaking, the next state is 0, the *dead state* corresponding to the empty set of NFA states). At that point, we back up through the sequence of states we entered and, as soon as we meet an accepting DFA state, we perform the action associated with the pattern for that state.

**Example 3.29:** Suppose the DFA of Fig. 3.54 is given input *abba*. The sequence of states entered is 0137,247,58,68, and at the final *a* there is no transition out of state 68. Thus, we consider the sequence from the end, and in this case, 68 itself is an accepting state that reports pattern  $p_3 = \mathbf{abb}$ . •

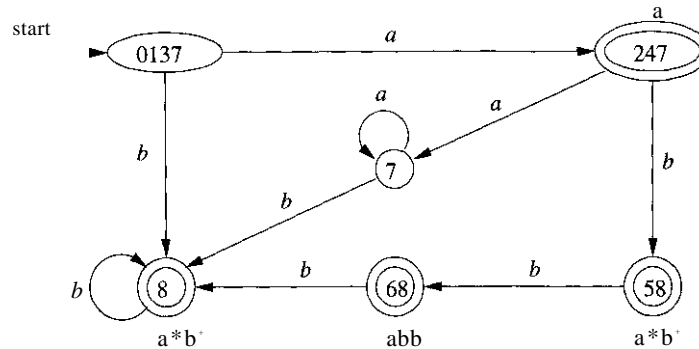

Figure 3.54: Transition graph for DFA handling the patterns **a**, **abb**, and **a\*b**.

### 3.8.4 Implementing the Lookahead Operator

Recall from Section 3.5.4 that the **Lex** lookahead operator  $/$  in a **Lex** pattern  $r_1/r_2$  is sometimes necessary, because the pattern  $r_1^*$  for a particular token may need to describe some trailing context  $r_2$  in order to correctly identify the actual lexeme. When converting the pattern  $r_1/r_2$  to an NFA, we treat the  $/$  as if it were  $\epsilon$ , so we do not actually look for a  $/$  on the input. However, if the NFA recognizes a prefix  $xy$  of the input buffer as matching this regular expression, the end of the lexeme is not where the NFA entered its accepting state. Rather the end occurs when the NFA enters a state  $s$  such that

1.  $s$  has an  $\epsilon$ -transition on the (imaginary)  $/$ ,
2. There is a path from the start state of the NFA to state  $s$  that spells out  $x$ .
3. There is a path from state  $s$  to the accepting state that spells out  $y$ .
4.  $x$  is as long as possible for any  $xy$  satisfying conditions 1-3.

If there is only one  $\epsilon$ -transition state on the imaginary  $/$  in the NFA, then the end of the lexeme occurs when this state is entered for the last time as the following example illustrates. If the NFA has more than one  $\epsilon$ -transition state on the imaginary  $/$ , then the general problem of finding the correct state  $s$  is much more difficult.

**Example 3.30:** An NFA for the pattern for the Fortran **IF** with lookahead, from Example 3.13, is shown in Fig. 3.55. Notice that the  $\epsilon$ -transition from state 2 to state 3 represents the lookahead operator. State 6 indicates the presence of the keyword **IF**. However, we find the lexeme **IF** by scanning backwards to the last occurrence of state 2, whenever state 6 is entered. •

### Dead States in DFA's

Technically, the automaton in Fig. 3.54 is not quite a DFA. The reason is that a DFA has a transition from every state on every input symbol in its input alphabet. Here, we have omitted transitions to the dead state 0, and we have therefore omitted the transitions from the dead state to itself on every input. Previous NFA-to-DFA examples did not have a way to get from the start state to 0, but the NFA of Fig. 3.52 does.

However, when we construct a DFA for use in a lexical analyzer, it is important that we treat the dead state differently, since we must know when there is no longer any possibility of recognizing a longer lexeme. Thus, we suggest always omitting transitions to the dead state and eliminating the dead state itself. In fact, the problem is harder than it appears, since an NFA-to-DFA construction may yield several states that cannot reach any accepting state, and we must know when any of these states have been reached. Section 3.9.6 discusses how to combine all these states into one dead state, so their identification becomes easy. It is also interesting to note that if we construct a DFA from a regular expression using Algorithms 3.20 and 3.23, then the DFA will not have any states besides 0 that cannot lead to an accepting state.

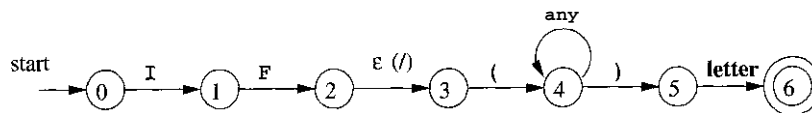

Figure 3.55: NFA recognizing the keyword IF

### 3.8.5 Exercises for Section 3.8

**Exercise 3.8.1:** Suppose we have two tokens: (1) the keyword `if`, and (2) identifiers, which are strings of letters other than `if`. Show:

- The NFA for these tokens, and
- The DFA for these tokens.

**Exercise 3.8.2:** Repeat Exercise 3.8.1 for tokens consisting of (1) the keyword `while`, (2) the keyword `when`, and (3) identifiers consisting of strings of letters and digits, beginning with a letter.

**! Exercise 3.8.3:** Suppose we were to revise the definition of a DFA to allow zero or one transition out of each state on each input symbol (rather than exactly one such transition, as in the standard DFA definition). Some regular

expressions would then have smaller "DFA's" than they do under the standard definition of a DFA. Give an example of one such regular expression.

!! Exercise 3.8.4: Design an algorithm to recognize Lex-lookahead patterns of the form  $r_1/r_2$ , where  $r_1$  and  $r_2$  are regular expressions. Show how your algorithm works on the following inputs:

a)  $(abcd\backslash abc)jd$

b)  $(a\backslash ab)/ba$

c)  $aa * j a^*$

## 3.9 Optimization of DFA-Based Pattern Matchers

In this section we present three algorithms that have been used to implement and optimize pattern matchers constructed from regular expressions.

1. The first algorithm is useful in a Lex compiler, because it constructs a DFA directly from a regular expression, without constructing an intermediate NFA. The resulting DFA also may have fewer states than the DFA constructed via an NFA.
2. The second algorithm minimizes the number of states of any DFA, by combining states that have the same future behavior. The algorithm itself is quite efficient, running in time  $O(n \log n)$ , where  $n$  is the number of states of the DFA.
3. The third algorithm produces more compact representations of transition tables than the standard, two-dimensional table.

### 3.9.1 Important States of an NFA

To begin our discussion of how to go directly from a regular expression to a DFA, we must first dissect the NFA construction of Algorithm 3.23 and consider the roles played by various states. We call a state of an NFA *important* if it has a non- $\epsilon$  out-transition. Notice that the subset construction (Algorithm 3.20) uses only the important states in a set  $T$  when it computes  $e\text{-closure}(\text{move}(T, a))$ , the set of states reachable from  $T$  on input  $a$ . That is, the set of states  $\text{move}(s, a)$  is nonempty only if state  $s$  is important. During the subset construction, two sets of NFA states can be identified (treated as if they were the same set) if they:

1. Have the same important states, and
2. Either both have accepting states or neither does.

When the NFA is constructed from a regular expression by Algorithm 3.23, we can say more about the important states. The only important states are those introduced as initial states in the basis part for a particular symbol position in the regular expression. That is, each important state corresponds to a particular operand in the regular expression.

The constructed NFA has only one accepting state, but this state, having no out-transitions, is not an important state. By concatenating a unique right endmarker # to a regular expression  $r$ , we give the accepting state for  $r$  a transition on #, making it an important state of the NFA for  $(r)\#$ . In other words, by using the *augmented* regular expression  $(r)\#$ , we can forget about accepting states as the subset construction proceeds; when the construction is complete, any state with a transition on # must be an accepting state.

The important states of the NFA correspond directly to the positions in the regular expression that hold symbols of the alphabet. It is useful, as we shall see, to present the regular expression by its *syntax tree*, where the leaves correspond to operands and the interior nodes correspond to operators. An interior node is called a *cat-node*, *or-node*, or *star-node* if it is labeled by the concatenation operator (dot), union operator |, or star operator \*, respectively. We can construct a syntax tree for a regular expression just as we did for arithmetic expressions in Section 2.5.1.

**Example 3.31:** Figure 3.56 shows the syntax tree for the regular expression of our running example. Cat-nodes are represented by circles. •

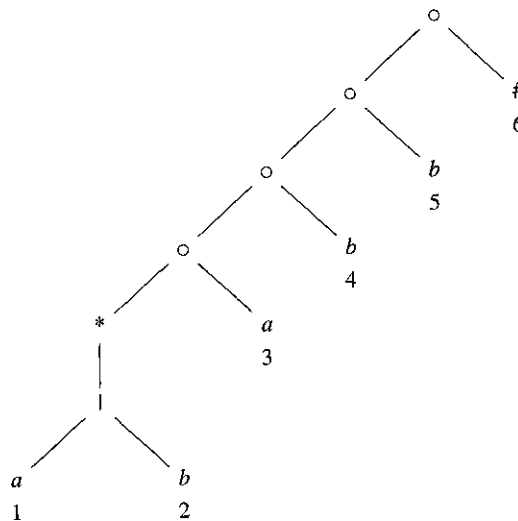

Figure 3.56: Syntax tree for  $(a|b)^*abb\#$

Leaves in a syntax tree are labeled by  $\epsilon$  or by an alphabet symbol. To each leaf not labeled  $\epsilon$ , we attach a unique integer. We refer to this integer as the

position of the leaf and also as a position of its symbol. Note that a symbol can have several positions; for instance,  $a$  has positions 1 and 3 in Fig. 3.56. The positions in the syntax tree correspond to the important states of the constructed NFA.

Example 3.32: Figure 3.57 shows the NFA for the same regular expression as Fig. 3.56, with the important states numbered and other states represented by letters. The numbered states in the NFA and the positions in the syntax tree correspond in a way we shall soon see. •

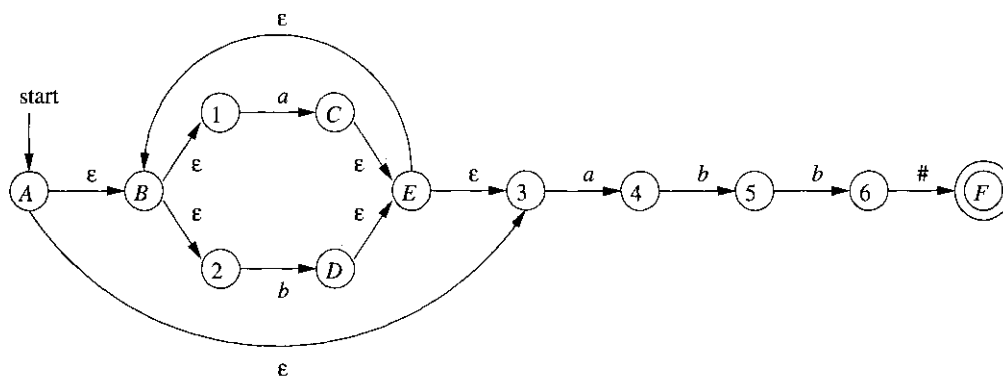

Figure 3.57: NFA constructed by Algorithm 3.23 for  $(a|b)^*abb\#$

### 3.9.2 Functions Computed From the Syntax Tree

To construct a DFA directly from a regular expression, we construct its syntax tree and then compute four functions: *nullable*, *firstpos*, *lastpos*, and *followpos*, defined as follows. Each definition refers to the syntax tree for a particular augmented regular expression  $(r)\#$ .

1. *nullable*( $n$ ) is true for a syntax-tree node  $n$  if and only if the subexpression represented by  $n$  has  $\epsilon$  in its language. That is, the subexpression can be "made null" or the empty string, even though there may be other strings it can represent as well.
2. *firstpos*( $n$ ) is the set of positions in the subtree rooted at  $n$  that correspond to the first symbol of at least one string in the language of the subexpression rooted at  $n$ .
3. *lastpos*( $n$ ) is the set of positions in the subtree rooted at  $n$  that correspond to the last symbol of at least one string in the language of the subexpression rooted at  $n$ .

4.  $followpos(p)$ , for a position  $p$ , is the set of positions  $q$  in the entire syntax tree such that there is some string  $x = a_1 a_2 \dots a_n$  in  $L((r)\#)$  such that for some  $i$ , there is a way to explain the membership of  $x$  in  $L((r)\#)$  by matching  $a_i$  to position  $p$  of the syntax tree and  $a_{i+1}$  to position  $q$ .

**Example 3.33:** Consider the cat-node  $n$  in Fig. 3.56 that corresponds to the expression  $(a|b)^*a$ . We claim  $nullable(n)$  is false, since this node generates all strings of  $a$ 's and  $b$ 's ending in an  $a$ ; it does not generate  $\epsilon$ . On the other hand, the star-node below it is nullable; it generates  $\epsilon$  along with all other strings of  $a$ 's and  $b$ 's.

$firstpos(n) = \{1, 2, 3\}$ . In a typical generated string like  $aa$ , the first position of the string corresponds to position 1 of the tree, and in a string like  $ba$ , the first position of the string comes from position 2 of the tree. However, when the string generated by the expression of node  $n$  is just  $a$ , then this  $a$  comes from position 3.

$lastpos(n) = \{3\}$ . That is, no matter what string is generated from the expression of node  $n$ , the last position is the  $a$  from position 3 of the tree.

$followpos$  is trickier to compute, but we shall see the rules for doing so shortly. Here is an example of the reasoning:  $followpos(1) = \{1, 2, 3\}$ . Consider a string  $\dots ac \dots$ , where the  $c$  is either  $a$  or  $b$ , and the  $a$  comes from position 1. That is, this  $a$  is one of those generated by the  $a$  in expression  $(a|b)^*$ . This  $a$  could be followed by another  $a$  or  $b$  coming from the same subexpression, in which case  $c$  comes from position 1 or 2. It is also possible that this  $a$  is the last in the string generated by  $(a|b)^*$ , in which case the symbol  $c$  must be the  $a$  that comes from position 3. Thus, 1, 2, and 3 are exactly the positions that can follow position 1. • • •

### 3.9.3 Computing $nullable$ , $firstpos$ , and $lastpos$

We can compute  $nullable$ ,  $firstpos$ , and  $lastpos$  by a straightforward recursion on the height of the tree. The basis and inductive rules for  $nullable$  and  $firstpos$  are summarized in Fig. 3.58. The rules for  $lastpos$  are essentially the same as for  $firstpos$ , but the roles of children  $c_1$  and  $c_2$  must be swapped in the rule for a cat-node.

**Example 3.34:** Of all the nodes in Fig. 3.56 only the star-node is nullable. We note from the table of Fig. 3.58 that none of the leaves are nullable, because they each correspond to non- $\epsilon$  operands. The or-node is not nullable, because neither of its children is. The star-node is nullable, because every star-node is nullable. Finally, each of the cat-nodes, having at least one nonnullable child, is not nullable.

The computation of  $firstpos$  and  $lastpos$  for each of the nodes is shown in Fig. 3.59, with  $firstpos(n)$  to the left of node  $n$ , and  $lastpos(n)$  to its right. Each of the leaves has only itself for  $firstpos$  and  $lastpos$ , as required by the rule for non- $\epsilon$  leaves in Fig. 3.58. For the or-node, we take the union of  $firstpos$  at the

NODE $n$	$nullable(n)$	$firstpos(n)$
A leaf labeled $e$	true	0
A leaf with position $i$	false	$\ll$
An or-node $n = c \setminus c_2$	$nullable(c \setminus)$ or $nullable(c_2)$	$firstpos(c \setminus) \cup firstpos(c_2)$
A cat-node $n = C \quad 1$	$nullable(c_1)$ and $nullable(c_2)$	if ( $nullable(c_1)$ ) $firstpos(c \setminus) \cup firstpos(c_2)$ else $firstpos(c_1)$
A star-node $n = c \setminus *$	true	$firstpos(c_1)$

Figure 3.58: Rules for computing *nullable* and *firstpos*

children and do the same for *lastpos*. The rule for the star-node says that we take the value of *firstpos* or *lastpos* at the one child of that node.

Now, consider the lowest cat-node, which we shall call  $n$ . To compute  $firstpos(n)$ , we first consider whether the left operand is nullable, which it is in this case. Therefore,  $firstpos$  for  $n$  is the union of  $firstpos$  for each of its children, that is  $\{1,2\} \cup \{3\} = \{1,2,3\}$ . The rule for *lastpos* does not appear explicitly in Fig. 3.58, but as we mentioned, the rules are the same as for *firstpos*, with the children interchanged. That is, to compute  $lastpos(n)$  we must ask whether its right child (the leaf with position 3) is nullable, which it is not. Therefore,  $lastpos(n)$  is the same as  $lastpos$  of the right child, or  $\{3\}$ .

•

### 3.9.4 Computing *followpos*

Finally, we need to see how to compute *followpos*. There are only two ways that a position of a regular expression can be made to follow another.

1. If  $n$  is a cat-node with left child  $c \setminus$  and right child  $C \quad 2$ , then for every position  $i$  in  $lastpos(c_1)$ , all positions in  $firstpos(c_2)$  are in  $followpos(i)$ .
2. If  $n$  is a star-node, and  $i$  is a position in  $lastpos(n)$ , then all positions in  $firstpos(n)$  are in  $followpos(i)$ .

**Example 3.35** : Let us continue with our running example; recall that *firstpos* and *lastpos* were computed in Fig. 3.59. Rule 1 for *followpos* requires that we look at each cat-node, and put each position in *firstpos* of its right child in *followpos* for each position in *lastpos* of its left child. For the lowest cat-node in Fig. 3.59, that rule says position 3 is in  $followpos(1)$  and  $followpos(2)$ . The next cat-node above says that 4 is in  $followpos(2>)$ , and the remaining two cat-nodes give us 5 in  $followpos(4)$  and 6 in  $followpos(5)$ .

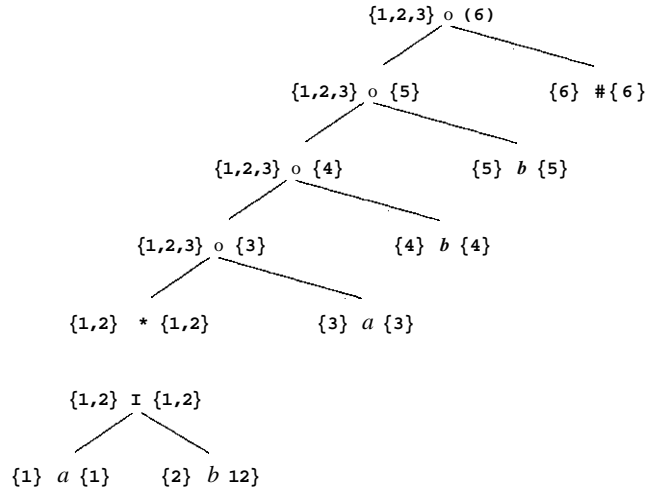

Figure 3.59: *firstpos* and *lastpos* for nodes in the syntax tree for  $(a|b)^*abb\#$ 

We must also apply rule 2 to the star-node. That rule tells us positions 1 and 2 are in both  $followpos(1)$  and  $followpos(2)$ , since both  $firstpos$  and  $lastpos$  for this node are  $\{1,2\}$ . The complete sets  $followpos$  are summarized in Fig. 3.60.

•

NODE	$n$	$followpos(n)$
1		$\{1,2,3\}$
2		$\{1,2,3\}$
3		$\{4\}$
4		$\{5\}$
5		$\{6\}$
6		$0$

Figure 3.60: The function  $followpos$ 

We can represent the function  $followpos$  by creating a directed graph with a node for each position and an arc from position  $i$  to position  $j$  if and only if  $j$  is in  $followpos(i)$ . Figure 3.61 shows this graph for the function of Fig. 3.60.

It should come as no surprise that the graph for  $followpos$  is almost an NFA without  $\epsilon$ -transitions for the underlying regular expression, and would become one if we:

1. Make all positions in  $firstpos$  of the root be initial states,
2. Label each arc from  $i$  to  $j$  by the symbol at position  $i$ , and

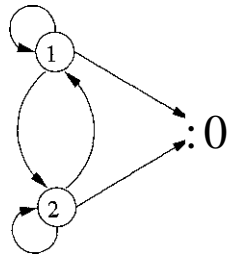
Figure 3.61: Directed graph for the function *followpos*

3. Make the position associated with endmarker # be the only accepting state.

### 3.9.5 Converting a Regular Expression Directly to a DFA

**Algorithm 3.36:** Construction of a DFA from a regular expression  $r$ .

**INPUT:** A regular expression  $r$ .

**OUTPUT:** A DFA  $D$  that recognizes  $L(r)$ .

**METHOD:**

1. Construct a syntax tree  $T$  from the augmented regular expression  $(r)\#$ .
2. Compute *nullable*, *firstpos*, *lastpos*, and *followpos* for  $T$ , using the methods of Sections 3.9.3 and 3.9.4.
3. Construct  $Dstates$ , the set of states of DFA  $D$ , and  $Dtran$ , the transition function for  $D$ , by the procedure of Fig. 3.62. The states of  $D$  are sets of positions in  $T$ . Initially, each state is "unmarked," and a state becomes "marked" just before we consider its out-transitions. The start state of  $D$  is  $firstpos(no)$ , where node  $no$  is the root of  $T$ . The accepting states are those containing the position for the endmarker symbol #.

•

**Example 3.37:** We can now put together the steps of our running example to construct a DFA for the regular expression  $r = (\mathbf{a|b})^*\mathbf{abb}$ . The syntax tree for  $(r)\#$  appeared in Fig. 3.56. We observed that for this tree, *nullable* is true only for the star-node, and we exhibited *firstpos* and *lastpos* in Fig. 3.59. The values of *followpos* appear in Fig. 3.60.

The value of *firstpos* for the root of the tree is  $\{1,2,3\}$ , so this set is the start state of  $D$ . Call this set of states  $A$ . We must compute  $Dtran[A, a]$  and  $Dtran[A, b]$ . Among the positions of  $A$ , 1 and 3 correspond to  $a$ , while 2 corresponds to  $b$ . Thus,  $Dtran[A, a] = followpos(1) \cup followpos(3) = \{1,2,3,4\}$ ,

```

initialize Dstates to contain only the unmarked state firstpos(no),
  where no is the root of syntax tree T for  $(r)\#$ ;
while ( there is an unmarked state S in Dstates ) {
  mark S;
  for ( each input symbol a ) {
    let U be the union of followpos(p) for all p
      in S that correspond to a;
    if ( U is not in Dstates )
      add U as an unmarked state to Dstates;
    Dtran[S, a] = U;
  }
}

```

Figure 3.62: Construction of a DFA directly from a regular expression

and  $Dtran[A, b] = followpos(2) = \{1, 2, 3\}$ . The latter is state *A*, and so does not have to be added to *Dstates*, but the former,  $B = \{1, 2, 3, 4\}$ , is new, so we add it to *Dstates* and proceed to compute its transitions. The complete DFA is shown in Fig. 3.63. •

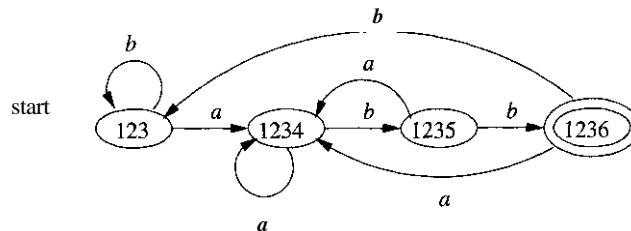

Figure 3.63: DFA constructed from Fig. 3.57

### 3.9.6 Minimizing the Number of States of a DFA

There can be many DFA's that recognize the same language. For instance, note that the DFA's of Figs. 3.36 and 3.63 both recognize language  $L((a|b)^*abb)$ . Not only do these automata have states with different names, but they don't even have the same number of states. If we implement a lexical analyzer as a DFA, we would generally prefer a DFA with as few states as possible, since each state requires entries in the table that describes the lexical analyzer.

The matter of the names of states is minor. We shall say that two automata are *the same up to state names* if one can be transformed into the other by doing nothing more than changing the names of states. Figures 3.36 and 3.63 are not the same up to state names. However, there is a close relationship between the

states of each. States  $A$  and  $C$  of Fig. 3.36 are actually equivalent, in the sense that neither is an accepting state, and on any input they transfer to the same state — to  $B$  on input  $a$  and to  $C$  on input  $b$ . Moreover, both states  $A$  and  $C$  behave like state 123 of Fig. 3.63. Likewise, state  $B$  of Fig. 3.36 behaves like state 1234 of Fig. 3.63, state  $D$  behaves like state 1235, and state  $E$  behaves like state 1236.

It turns out that there is always a unique (up to state names) minimum state DFA for any regular language. Moreover, this minimum-state DFA can be constructed from any DFA for the same language by grouping sets of equivalent states. In the case of  $L((a|b)^*abb)$ , Fig. 3.63 is the minimum-state DFA, and it can be constructed by partitioning the states of Fig. 3.36 as  $\{A, C\}/\{B\}/\{D\}/\{E\}$ .

In order to understand the algorithm for creating the partition of states that converts any DFA into its minimum-state equivalent DFA, we need to see how input strings distinguish states from one another. We say that string  $x$  *distinguishes* state  $s$  from state  $t$  if exactly one of the states reached from  $s$  and  $t$  by following the path with label  $x$  is an accepting state. State  $s$  is *distinguishable* from state  $t$  if there is some string that distinguishes them.

**Example 3.38:** The empty string distinguishes any accepting state from any nonaccepting state. In Fig. 3.36, the string  $bb$  distinguishes state  $A$  from state  $B$ , since  $bb$  takes  $A$  to a nonaccepting state  $C$ , but takes  $B$  to accepting state  $E$ . •

The state-minimization algorithm works by partitioning the states of a DFA into groups of states that cannot be distinguished. Each group of states is then merged into a single state of the minimum-state DFA. The algorithm works by maintaining a partition, whose groups are sets of states that have not yet been distinguished, while any two states from different groups are known to be distinguishable. When the partition cannot be refined further by breaking any group into smaller groups, we have the minimum-state DFA.

Initially, the partition consists of two groups: the accepting states and the nonaccepting states. The fundamental step is to take some group of the current partition, say  $A = \{s_i, s_j, \dots, s_k\}$ , and some input symbol  $a$ , and see whether  $a$  can be used to distinguish between any states in group  $A$ . We examine the transitions from each of  $s_i, s_j, \dots, s_k$  on input  $a$ , and if the states reached fall into two or more groups of the current partition, we split  $A$  into a collection of groups, so that  $s_i$  and  $s_j$  are in the same group if and only if they go to the same group on input  $a$ . We repeat this process of splitting groups, until for no group, and for no input symbol, can the group be split further. The idea is formalized in the next algorithm.

**Algorithm 3.39:** Minimizing the number of states of a DFA.

**INPUT:** A DFA  $D$  with set of states  $S$ , input alphabet  $\Sigma$ , state  $s_0$ , and set of accepting states  $F$ .

**OUTPUT:** A DFA  $D'$  accepting the same language as  $D$  and having as few states as possible.

### Why the State-Minimization Algorithm Works

We need to prove two things: that states remaining in the same group in **Hfinal** are indistinguishable by any string, and that states winding up in different groups are distinguishable. The first is an induction on  $i$  that if after the  $i$ th iteration of step (2) of Algorithm 3.39,  $s$  and  $t$  are in the same group, then there is no string of length  $i$  or less that distinguishes them. We shall leave the details of the induction to you.

The second is an induction on  $i$  that if states  $s$  and  $t$  are placed in different groups at the  $i$ th iteration of step (2), then there is a string that distinguishes them. The basis, when  $s$  and  $t$  are placed in different groups of the initial partition, is easy: one must be accepting and the other not, so  $\epsilon$  distinguishes them. For the induction, there must be an input  $a$  and states  $p$  and  $q$  such that  $s$  and  $t$  go to states  $p$  and  $q$ , respectively, on input  $a$ . Moreover,  $p$  and  $q$  must already have been placed in different groups. Then by the inductive hypothesis, there is some string  $x$  that distinguishes  $p$  from  $q$ . Therefore,  $ax$  distinguishes  $s$  from  $t$ .

#### METHOD:

1. Start with an initial partition  $\Pi$  with two groups,  $F$  and  $S - F$ , the accepting and nonaccepting states of  $D$ .
2. Apply the procedure of Fig. 3.64 to construct a new partition  $\Pi_{new}$

```

initially, let  $\Pi_{new} = \Pi$ ;
for ( each group  $G$  of  $U$  ) {
    partition  $G$  into subgroups such that two states  $s$  and  $t$ 
        are in the same subgroup if and only if for all
        input symbols  $a$ , states  $s$  and  $t$  have transitions on  $a$ 
        to states in the same group of  $\Pi$ ;
    /* at worst, a state will be in a subgroup by itself */
    replace  $G$  in  $\Pi_{new}$  by the set of all subgroups formed;
}

```

Figure 3.64: Construction of  $\Pi_{new}$

3. If  $\Pi_{new} = \Pi$ , let  $\Pi_{final} = \Pi$  and continue with step (4). Otherwise, repeat step (2) with  $\Pi_{new}$  in place of  $\Pi$ .
4. Choose one state in each group of  $\Pi_{final}$  as the *representative* for that group. The representatives will be the states of the minimum-state DFA  $D'$ . The other components of  $D'$  are constructed as follows:

## Eliminating the Dead State

The minimization algorithm sometimes produces a DFA with one dead state — one that is not accepting and transfers to itself on each input symbol. This state is technically needed, because a DFA must have a transition from every state on every symbol. However, as discussed in Section 3.8.3, we often want to know when there is no longer any possibility of acceptance, so we can establish that the proper lexeme has already been seen. Thus, we may wish to eliminate the dead state and use an automaton that is missing some transitions. This automaton has one fewer state than the minimum-state DFA, but is strictly speaking not a DFA, because of the missing transitions to the dead state.

- (a) The state state of  $D'$  is the representative of the group containing the start state of  $D$ .
- (b) The accepting states of  $D'$  are the representatives of those groups that contain an accepting state of  $D$ . Note that each group contains either only accepting states, or only nonaccepting states, because we started by separating those two classes of states, and the procedure of Fig. 3.64 always forms new groups that are subgroups of previously constructed groups.
- (c) Let  $s$  be the representative of some group  $G$  of  $\mathbf{nfi}_i$ , and let the transition of  $D$  from  $s$  on input  $a$  be to state  $t$ . Let  $r$  be the representative of  $fs$  group  $H$ . Then in  $D'$ , there is a transition from  $s$  to  $r$  on input  $a$ . Note that in  $D$ , every state in group  $G$  must go to some state of group  $H$  on input  $a$ , or else, group  $G$  would have been split according to Fig. 3.64.

Example 3.40: Let us reconsider the DFA of Fig. 3.36. The initial partition consists of the two groups  $\{A, B, C, D\}\{E\}$ , which are respectively the nonaccepting states and the accepting states. To construct  $\mathbf{n}_{ew}$ , the procedure of Fig. 3.64 considers both groups and inputs  $a$  and  $b$ . The group  $\{E\}$  cannot be split, because it has only one state, so  $\{E\}$  will remain intact in  $\mathbf{n}_{...}$ .

The other group  $\{A, B, C, D\}$  can be split, so we must consider the effect of each input symbol. On input  $a$ , each of these states goes to state  $B$ , so there is no way to distinguish these states using strings that begin with  $a$ . On input  $b$ , states  $A$ ,  $C$ , and  $D$  go to members of group  $\{A, B, C, D\}$  while state  $B$  goes to  $E$ , a member of another group. Thus, in  $\mathbf{n}_{...}$ , group  $\{A, B, C, D\}$  is split into  $\{A, B, C\}\{D\}$ , and  $\mathbf{n}_{...}$  for this round is  $\{A, B, C\}\{D\}\{E\}$ .

In the next round, we can split  $\{A,B,C\}$  into  $\{A,C\}\{B\}$ , since  $A$  and  $C$  each go to a member of  $\{A, B, C\}$  on input  $b$ , while  $B$  goes to a member of another group,  $\{D\}$ . Thus, after the second round,  $n_{i,w} = \{A, C\}\{B\}\{D\}\{E\}$ . For the third round, we cannot split the one remaining group with more than one state, since  $A$  and  $C$  each go to the same state (and therefore to the same group) on each input. We conclude that  $\Pi_{i,i} = \{A, C\}\{B\}\{D\}\{E\}$ .

Now, we shall construct the minimum-state DFA. It has four states, corresponding to the four groups of  $U_{i,w}$ , and let us pick  $A, B, D,$  and  $E$  as the representatives of these groups. The initial state is  $A$ , and the only accepting state is  $E$ . Figure 3.65 shows the transition function for the DFA. For instance, the transition from state  $E$  on input  $b$  is to  $A$ , since in the original DFA,  $E$  goes to  $C$  on input  $b$ , and  $A$  is the representative of  $C$ 's group. For the same reason, the transition on  $b$  from state  $A$  is to  $A$  itself, while all other transitions are as in Fig. 3.36. •

STATE	$a$	$b$
$A$	$B$	$A$
$B$	$B$	$D$
$D$	$B$	$E$
$E$	$B$	$A$

Figure 3.65: Transition table of minimum-state DFA

### 3.9.7 State Minimization in Lexical Analyzers

To apply the state minimization procedure to the DFA's generated in Section 3.8.3, we must begin Algorithm 3.39 with the partition that groups together all states that recognize a particular token, and also places in one group all those states that do not indicate any token. An example should make the extension clear.

Example 3.41: For the DFA of Fig. 3.54, the initial partition is

$$\{0137,7\}\{247\}\{8,58\}\{7\}\{68\}\{0\}$$

That is, states 0137 and 7 belong together because neither announces any token. States 8 and 58 belong together because they both announce token  $a^*b^+$ . Note that we have added a dead state 0, which we suppose has transitions to itself on inputs  $a$  and  $b$ . The dead state is also the target of missing transitions on  $a$  from states 8, 58, and 68.

We must split 0137 from 7, because they go to different groups on input  $a$ . We also split 8 from 58, because they go to different groups on  $b$ . Thus, all states are in groups by themselves, and Fig. 3.54 is the minimum-state DFA

recognizing its three tokens. Recall that a DFA serving as a lexical analyzer will normally drop the dead state, while we treat missing transitions as a signal to end token recognition. •

### 3.9.8 Trading Time for Space in DFA Simulation

The simplest and fastest way to represent the transition function of a DFA is a two-dimensional table indexed by states and characters. Given a state and next input character, we access the array to find the next state and any special action we must take, e.g., returning a token to the parser. Since a typical lexical analyzer has several hundred states in its DFA and involves the ASCII alphabet of 128 input characters, the array consumes less than a megabyte.

However, compilers are also appearing in very small devices, where even a megabyte of storage may be too much. For such situations, there are many methods that can be used to compact the transition table. For instance, we can represent each state by a list of transitions — that is, character-state pairs — ended by a default state that is to be chosen for any input character not on the list. If we choose as the default the most frequently occurring next state, we can often reduce the amount of storage needed by a large factor.

There is a more subtle data structure that allows us to combine the speed of array access with the compression of lists with defaults. We may think of this structure as four arrays, as suggested in Fig. 3.66.<sup>5</sup> The *base* array is used to determine the base location of the entries for state *s*, which are located in the *next* and *check* arrays. The *default* array is used to determine an alternative base location if the *check* array tells us the one given by *base[s]* is invalid.

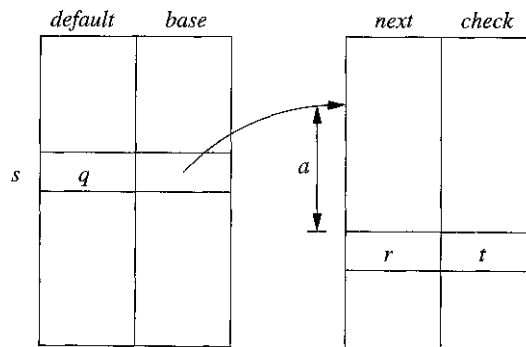

Figure 3.66: Data structure for representing transition tables

To compute  $nextState(s, a)$ , the transition for state *s* on input *a*, we examine the *next* and *check* entries in location  $I = base[s] + a$ , where character *a* is treated as an integer, presumably in the range 0 to 127. If  $check[I] = s$ , then this entry

<sup>5</sup>In practice, there would be another array indexed by states to give the action associated with that state, if any.



is valid, and the next state for state  $s$  on input  $a$  is  $next[l]$ . If  $check[l] \wedge s$ , then we determine another state  $t = default[s]$  and repeat the process as if  $t$  were the current state. More formally, the function *nextState* is defined as follows:

```
int nextState(s,a) {
    if ( check[base[s] + a] = s ) return next[base[s] + a];
    else return nextState(default[s],a);
}
```

The intended use of the structure of Fig. 3.66 is to make the *next-check* arrays short by taking advantage of the similarities among states. For instance, state  $t$ , the default for state  $s$ , might be the state that says "we are working on an identifier," like state 10 in Fig. 3.14. Perhaps state  $s$  is entered after seeing the letters *th*, which are a prefix of keyword then as well as potentially being the prefix of some lexeme for an identifier. On input character *e*, we must go from state  $s$  to a special state that remembers we have seen the, but otherwise, state  $s$  behaves as  $t$  does. Thus, we set  $check[base[s] + e]$  to  $s$  (to confirm that this entry is valid for  $s$ ) and we set  $next[base[s] + e]$  to the state that remembers the. Also,  $default[s]$  is set to  $t$ .

While we may not be able to choose *base* values so that no *next-check* entries remain unused, experience has shown that the simple strategy of assigning *base* values to states in turn, and assigning each  $base[s]$  value the lowest integer so that the special entries for state  $s$  are not previously occupied utilizes little more space than the minimum possible.

### 3.9.9 Exercises for Section 3.9

Exercise 3.9.1: Extend the table of Fig. 3.58 to include the operators (a) ? and (b) + .

Exercise 3.9.2: Use Algorithm 3.36 to convert the regular expressions of Exercise 3.7.3 directly to deterministic finite automata.

! Exercise 3.9.3: We can prove that two regular expressions are equivalent by showing that their minimum-state DFA's are the same up to renaming of states. Show in this way that the following regular expressions:  $(a|b)^*$ ,  $(a^*|b^*)^*$ , and  $((e|a)b^*)^*$  are all equivalent. *Note:* You may have constructed the DFA's for these expressions in response to Exercise 3.7.3.

! Exercise 3.9.4: Construct the minimum-state DFA's for the following regular expressions:

- a)  $(a|b)^*a(a|b)$ .
- b)  $(a|b)^*a(a|b)(a|b)$ .
- c)  $(a|b)^*a(a|b)(a|b)(a|b)$ .

Do you see a pattern?

!! Exercise 3.9.5: To make formal the informal claim of Example 3.25, show that any deterministic finite automaton for the regular expression

$$(a|b)^*a(a|b)(a|b)\dots(a|b)$$

where  $(a|b)$  appears  $n - 1$  times at the end, must have at least  $2^n$  states. *Hint:* Observe the pattern in Exercise 3.9.4. What condition regarding the history of inputs does each state represent?

### 3.10 Summary of Chapter 3

- *Tokens.* The lexical analyzer scans the source program and produces as output a sequence of tokens, which are normally passed, one at a time to the parser. Some tokens may consist only of a token name while others may also have an associated lexical value that gives information about the particular instance of the token that has been found on the input.
- *Lexemes.* Each time the lexical analyzer returns a token to the parser, it has an associated lexeme — the sequence of input characters that the token represents.
- *Buffering.* Because it is often necessary to scan ahead on the input in order to see where the next lexeme ends, it is usually necessary for the lexical analyzer to buffer its input. Using a pair of buffers cyclicly and ending each buffer's contents with a sentinel that warns of its end are two techniques that accelerate the process of scanning the input.
- *Patterns.* Each token has a pattern that describes which sequences of characters can form the lexemes corresponding to that token. The set of words, or strings of characters, that match a given pattern is called a language.
- *Regular Expressions.* These expressions are commonly used to describe patterns. Regular expressions are built from single characters, using union, concatenation, and the Kleene closure, or any-number-of, operator.
- *Regular Definitions.* Complex collections of languages, such as the patterns that describe the tokens of a programming language, are often defined by a regular definition, which is a sequence of statements that each define one variable to stand for some regular expression. The regular expression for one variable can use previously defined variables in its regular expression.

- 4- *Extended Regular-Expression Notation.* A number of additional operators may appear as shorthands in regular expressions, to make it easier to express patterns. Examples include the + operator (one-or-more-of), ? (zero-or-one-of), and character classes (the union of the strings each consisting of one of the characters).
- *Transition Diagrams.* The behavior of a lexical analyzer can often be described by a transition diagram. These diagrams have states, each of which represents something about the history of the characters seen during the current search for a lexeme that matches one of the possible patterns. There are arrows, or transitions, from one state to another, each of which indicates the possible next input characters that cause the lexical analyzer to make that change of state.
- *Finite Automata.* These are a formalization of transition diagrams that include a designation of a start state and one or more accepting states, as well as the set of states, input characters, and transitions among states. Accepting states indicate that the lexeme for some token has been found. Unlike transition diagrams, finite automata can make transitions on empty input as well as on input characters.
- *Deterministic Finite Automata.* A DFA is a special kind of finite automaton that has exactly one transition out of each state for each input symbol. Also, transitions on empty input are disallowed. The DFA is easily simulated and makes a good implementation of a lexical analyzer, similar to a transition diagram.
- *Nondeterministic Finite Automata.* Automata that are not DFA's are called nondeterministic. NFA's often are easier to design than are DFA's. Another possible architecture for a lexical analyzer is to tabulate all the states that NFA's for each of the possible patterns can be in, as we scan the input characters.
- *Conversion Among Pattern Representations.* It is possible to convert any regular expression into an NFA of about the same size, recognizing the same language as the regular expression defines. Further, any NFA can be converted to a DFA for the same pattern, although in the worst case (never encountered in common programming languages) the size of the automaton can grow exponentially. It is also possible to convert any nondeterministic or deterministic finite automaton into a regular expression that defines the same language recognized by the finite automaton.
- \* *Lex.* There is a family of software systems, including **Lex** and **Flex**, that are lexical-analyzer generators. The user specifies the patterns for tokens using an extended regular-expression notation. **Lex** converts these expressions into a lexical analyzer that is essentially a deterministic finite automaton that recognizes any of the patterns.

- *Minimization of Finite Automata.* For every DFA there is a minimum-state DFA accepting the same language. Moreover, the minimum-state DFA for a given language is unique except for the names given to the various states.

## 3.11 References for Chapter 3

Regular expressions were first developed by Kleene in the 1950's [9]. Kleene was interested in describing the events that could be represented by McCullough and Pitts' [12] finite-automaton model of neural activity. Since that time regular expressions and finite automata have become widely used in computer science.

Regular expressions in various forms were used from the outset in many popular Unix utilities such as `awk`, `ed`, `egrep`, `grep`, `lex`, `sed`, `sh`, and `vi`. The IEEE 1003 and ISO/IEC 9945 standards documents for the Portable Operating System Interface (POSIX) define the POSIX extended regular expressions which are similar to the original Unix regular expressions with a few exceptions such as mnemonic representations for character classes. Many scripting languages such as Perl, Python, and Tel have adopted regular expressions but often with incompatible extensions.

The familiar finite-automaton model and the minimization of finite automata, as in Algorithm 3.39, come from Huffman [6] and Moore [14]. Nondeterministic finite automata were first proposed by Rabin and Scott [15]; the subset construction of Algorithm 3.20, showing the equivalence of deterministic and nondeterministic finite automata, is from there.

McNaughton and Yamada [13] first gave an algorithm to convert regular expressions directly to deterministic finite automata. Algorithm 3.36 described in Section 3.9 was first used by Aho in creating the Unix regular-expression matching tool `egrep`. This algorithm was also used in the regular-expression pattern matching routines in `awk` [3]. The approach of using nondeterministic automata as an intermediary is due Thompson [17]. The latter paper also contains the algorithm for the direct simulation of nondeterministic finite automata (Algorithm 3.22), which was used by Thompson in the text editor QED.

Lesk developed the first version of `Lex` and then Lesk and Schmidt created a second version using Algorithm 3.36 [10]. Many variants of `Lex` have been subsequently implemented. The GNU version, `Flex`, can be downloaded, along with documentation at [4]. Popular Java versions of Lex include `JFlex` [7] and `JLex` [8].

The KMP algorithm, discussed in the exercises to Section 3.4 just prior to Exercise 3.4.3, is from [11]. Its generalization to many keywords appears in [2] and was used by Aho in the first implementation of the Unix utility `fgrep`.

The theory of finite automata and regular expressions is covered in [5]. A survey of string-matching techniques is in [1].

1. Aho, A. V., "Algorithms for finding patterns in strings," in *Handbook of Theoretical Computer Science* (J. van Leeuwen, ed.), Vol. A, Ch. 5, MIT

- Press, Cambridge, 1990.
2. Aho, A. V. and M. J. Corasick, "Efficient string matching: an aid to bibliographic search," *Comm. ACM* 18:6 (1975), pp. 333-340.
  3. Aho, A. V., B. W. Kernighan, and P. J. Weinberger, *The AWK Programming Language*, Addison-Wesley, Boston, MA, 1988.
  4. Flex home page <http://www.gnu.org/software/flex/>, Free Software Foundation.
  5. Hopcroft, J. E., R. Motwani, and J. D. Ullman, *Introduction to Automata Theory, Languages, and Computation*, Addison-Wesley, Boston MA, 2006.
  6. Huffman, D. A., "The synthesis of sequential machines," *J. Franklin Inst.* 257 (1954), pp. 3-4, 161, 190, 275-303.
  7. JFlex home page <http://jflex.de/> .
  8. <http://www.cs.princeton.edu/~appel/modern/java/JLex> .
  9. Kleene, S. C., "Representation of events in nerve nets," in [16], pp. 3-40.
  10. Lesk, M. E., "Lex - a lexical analyzer generator," Computing Science Tech. Report 39, Bell Laboratories, Murray Hill, NJ, 1975. A similar document with the same title but with E. Schmidt as a coauthor, appears in Vol. 2 of the *Unix Programmer's Manual*, Bell laboratories, Murray Hill NJ, 1975; see <http://dinosaur.compilertools.net/lex/index.html>.
  11. Knuth, D. E., J. H. Morris, and V. R. Pratt, "Fast pattern matching in strings," *SIAM J. Computing* 6:2 (1977), pp. 323-350.
  12. McCullough, W. S. and W. Pitts, "A logical calculus of the ideas immanent in nervous activity," *Bull. Math. Biophysics* 5 (1943), pp. 115-133.
  13. McNaughton, R. and H. Yamada, "Regular expressions and state graphs for automata," *IRE Trans. on Electronic Computers* EC-9:1 (1960), pp. 38-47.
  14. Moore, E. F., "Gedanken experiments on sequential machines," in [16], pp. 129-153.
  15. Rabin, M. O. and D. Scott, "Finite automata and their decision problems," *IBM J. Res. and Devel.* 3:2 (1959), pp. 114-125.
  16. Shannon, C. and J. McCarthy (eds.), *Automata Studies*, Princeton Univ. Press, 1956.
  17. Thompson, K., "Regular expression search algorithm," *Comm. ACM* 11:6 (1968), pp. 419-422.

# Chapter 4

## Syntax Analysis

This chapter is devoted to parsing methods that are typically used in compilers. We first present the basic concepts, then techniques suitable for hand implementation, and finally algorithms that have been used in automated tools. Since programs may contain syntactic errors, we discuss extensions of the parsing methods for recovery from common errors.

By design, every programming language has precise rules that prescribe the syntactic structure of well-formed programs. In C, for example, a program is made up of functions, a function out of declarations and statements, a statement out of expressions, and so on. The syntax of programming language constructs can be specified by context-free grammars or BNF (Backus-Naur Form) notation, introduced in Section 2.2. Grammars offer significant benefits for both language designers and compiler writers.

- A grammar gives a precise, yet easy-to-understand, syntactic specification of a programming language.
- From certain classes of grammars, we can construct automatically an efficient parser that determines the syntactic structure of a source program. As a side benefit, the parser-construction process can reveal syntactic ambiguities and trouble spots that might have slipped through the initial design phase of a language.
- The structure imparted to a language by a properly designed grammar is useful for translating source programs into correct object code and for detecting errors.
- A grammar allows a language to be evolved or developed iteratively, by adding new constructs to perform new tasks. These new constructs can be integrated more easily into an implementation that follows the grammatical structure of the language.

## 4.1 Introduction

In this section, we examine the way the parser fits into a typical compiler. We then look at typical grammars for arithmetic expressions. Grammars for expressions suffice for illustrating the essence of parsing, since parsing techniques for expressions carry over to most programming constructs. This section ends with a discussion of error handling, since the parser must respond gracefully to finding that its input cannot be generated by its grammar.

### 4.1.1 The Role of the Parser

In our compiler model, the parser obtains a string of tokens from the lexical analyzer, as shown in Fig. 4.1, and verifies that the string of token names can be generated by the grammar for the source language. We expect the parser to report any syntax errors in an intelligible fashion and to recover from commonly occurring errors to continue processing the remainder of the program. Conceptually, for well-formed programs, the parser constructs a parse tree and passes it to the rest of the compiler for further processing. In fact, the parse tree need not be constructed explicitly, since checking and translation actions can be interspersed with parsing, as we shall see. Thus, the parser and the rest of the front end could well be implemented by a single module.

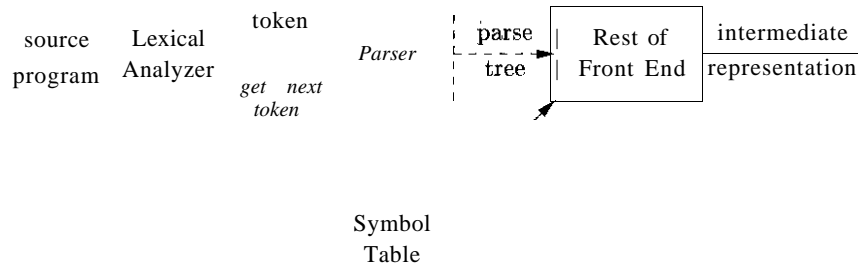

Figure 4.1: Position of parser in compiler model

There are three general types of parsers for grammars: universal, top-down, and bottom-up. Universal parsing methods such as the Cocke-Younger-Kasami algorithm and Earley's algorithm can parse any grammar (see the bibliographic notes). These general methods are, however, too inefficient to use in production compilers.

The methods commonly used in compilers can be classified as being either top-down or bottom-up. As implied by their names, top-down methods build parse trees from the top (root) to the bottom (leaves), while bottom-up methods start from the leaves and work their way up to the root. In either case, the input to the parser is scanned from left to right, one symbol at a time.

The most efficient top-down and bottom-up methods work only for subclasses of grammars, but several of these classes, particularly, LL and LR grammars, are expressive enough to describe most of the syntactic constructs in modern programming languages. Parsers implemented by hand often use LL grammars; for example, the predictive-parsing approach of Section 2.4.2 works for LL grammars. Parsers for the larger class of LR grammars are usually constructed using automated tools.

In this chapter, we assume that the output of the parser is some representation of the parse tree for the stream of tokens that comes from the lexical analyzer. In practice, there are a number of tasks that might be conducted during parsing, such as collecting information about various tokens into the symbol table, performing type checking and other kinds of semantic analysis, and generating intermediate code. We have lumped all of these activities into the "rest of the front end" box in Fig. 4.1. These activities will be covered in detail in subsequent chapters.

### 4.1.2 Representative Grammars

Some of the grammars that will be examined in this chapter are presented here for ease of reference. Constructs that begin with keywords like `while` or `int`, are relatively easy to parse, because the keyword guides the choice of the grammar production that must be applied to match the input. We therefore concentrate on expressions, which present more of a challenge, because of the associativity and precedence of operators.

Associativity and precedence are captured in the following grammar, which is similar to ones used in Chapter 2 for describing expressions, terms, and factors.  $E$  represents expressions consisting of terms separated by  $+$  signs,  $T$  represents terms consisting of factors separated by  $*$  signs, and  $F$  represents factors that can be either parenthesized expressions or identifiers:

$$\begin{array}{l} E \qquad E + T \mid T \\ T \quad -> T * F \mid F \\ F \qquad (E) \mid \text{id} \end{array} \qquad (4.1)$$

Expression grammar (4.1) belongs to the class of LR grammars that are suitable for bottom-up parsing. This grammar can be adapted to handle additional operators and additional levels of precedence. However, it cannot be used for top-down parsing because it is left recursive.

The following non-left-recursive variant of the expression grammar (4.1) will be used for top-down parsing:

$$\begin{array}{l} E \qquad T E' \\ E' \quad + T E' \mid e \\ T \qquad FT \\ V \qquad * F T' \mid e \\ F \qquad ( E ) \mid \text{id} \end{array} \qquad (4.2)$$



The following grammar treats + and \* alike, so it is useful for illustrating techniques for handling ambiguities during parsing:

$$E \rightarrow E + E \mid E * E \mid ( E ) \mid id \quad (4.3)$$

Here,  $E$  represents expressions of all types. Grammar (4.3) permits more than one parse tree for expressions like  $a + b*c$ .

### 4.1.3 Syntax Error Handling

The remainder of this section considers the nature of syntactic errors and general strategies for error recovery. Two of these strategies, called panic-mode and phrase-level recovery, are discussed in more detail in connection with specific parsing methods.

If a compiler had to process only correct programs, its design and implementation would be simplified greatly. However, a compiler is expected to assist the programmer in locating and tracking down errors that inevitably creep into programs, despite the programmer's best efforts. Strikingly, few languages have been designed with error handling in mind, even though errors are so commonplace. Our civilization would be radically different if spoken languages had the same requirements for syntactic accuracy as computer languages. Most programming language specifications do not describe how a compiler should respond to errors; error handling is left to the compiler designer. Planning the error handling right from the start can both simplify the structure of a compiler and improve its handling of errors.

Common programming errors can occur at many different levels.

- *Lexical* errors include misspellings of identifiers, keywords, or operators — e.g., the use of an identifier `ellipseSize` instead of `ellipseSize` — and missing quotes around text intended as a string.
- *Syntactic* errors include misplaced semicolons or extra or missing braces; that is, "{" or "}." As another example, in C or Java, the appearance of a case statement without an enclosing switch is a syntactic error (however, this situation is usually allowed by the parser and caught later in the processing, as the compiler attempts to generate code).
- *Semantic* errors include type mismatches between operators and operands. An example is a return statement in a Java method with result type void.
- *Logical* errors can be anything from incorrect reasoning on the part of the programmer to the use in a C program of the assignment operator = instead of the comparison operator ==. The program containing = may be well formed; however, it may not reflect the programmer's intent.

The precision of parsing methods allows syntactic errors to be detected very efficiently. Several parsing methods, such as the LL and LR methods, detect

an error as soon as possible; that is, when the stream of tokens from the lexical analyzer cannot be parsed further according to the grammar for the language. More precisely, they have the *viable-prefix property*, meaning that they detect that an error has occurred as soon as they see a prefix of the input that cannot be completed to form a string in the language.

Another reason for emphasizing error recovery during parsing is that many errors appear syntactic, whatever their cause, and are exposed when parsing cannot continue. A few semantic errors, such as type mismatches, can also be detected efficiently; however, accurate detection of semantic and logical errors at compile time is in general a difficult task.

The error handler in a parser has goals that are simple to state but challenging to realize:

- Report the presence of errors clearly and accurately.
- Recover from each error quickly enough to detect subsequent errors.
- Add minimal overhead to the processing of correct programs.

Fortunately, common errors are simple ones, and a relatively straightforward error-handling mechanism often suffices.

How should an error handler report the presence of an error? At the very least, it must report the place in the source program where an error is detected, because there is a good chance that the actual error occurred within the previous few tokens. A common strategy is to print the offending line with a pointer to the position at which an error is detected.

#### 4.1.4 Error-Recovery Strategies

Once an error is detected, how should the parser recover? Although no strategy has proven itself universally acceptable, a few methods have broad applicability. The simplest approach is for the parser to quit with an informative error message when it detects the first error. Additional errors are often uncovered if the parser can restore itself to a state where processing of the input can continue with reasonable hopes that the further processing will provide meaningful diagnostic information. If errors pile up, it is better for the compiler to give up after exceeding some error limit than to produce an annoying avalanche of "spurious" errors.

The balance of this section is devoted to the following recovery strategies: panic-mode, phrase-level, error-productions, and global-correction.

##### **Panic-Mode Recovery**

With this method, on discovering an error, the parser discards input symbols one at a time until one of a designated set of *synchronizing tokens* is found. The synchronizing tokens are usually delimiters, such as semicolon or }, whose role in the source program is clear and unambiguous. The compiler designer

must select the synchronizing tokens appropriate for the source language. While panic-mode correction often skips a considerable amount of input without checking it for additional errors, it has the advantage of simplicity, and, unlike some methods to be considered later, is guaranteed not to go into an infinite loop.

### Phrase-Level Recovery

On discovering an error, a parser may perform local correction on the remaining input; that is, it may replace a prefix of the remaining input by some string that allows the parser to continue. A typical local correction is to replace a comma by a semicolon, delete an extraneous semicolon, or insert a missing semicolon. The choice of the local correction is left to the compiler designer. Of course, we must be careful to choose replacements that do not lead to infinite loops, as would be the case, for example, if we always inserted something on the input ahead of the current input symbol.

Phrase-level replacement has been used in several error-repairing compilers, as it can correct any input string. Its major drawback is the difficulty it has in coping with situations in which the actual error has occurred before the point of detection.

### Error Productions

By anticipating common errors that might be encountered, we can augment the grammar for the language at hand with productions that generate the erroneous constructs. A parser constructed from a grammar augmented by these error productions detects the anticipated errors when an error production is used during parsing. The parser can then generate appropriate error diagnostics about the erroneous construct that has been recognized in the input.

### Global Correction

Ideally, we would like a compiler to make as few changes as possible in processing an incorrect input string. There are algorithms for choosing a minimal sequence of changes to obtain a globally least-cost correction. Given an incorrect input string  $x$  and grammar  $G$ , these algorithms will find a parse tree for a related string  $y$ , such that the number of insertions, deletions, and changes of tokens required to transform  $x$  into  $y$  is as small as possible. Unfortunately, these methods are in general too costly to implement in terms of time and space, so these techniques are currently only of theoretical interest.

Do note that a closest correct program may not be what the programmer had in mind. Nevertheless, the notion of least-cost correction provides a yardstick for evaluating error-recovery techniques, and has been used for finding optimal replacement strings for phrase-level recovery.

## 4.2 Context-Free Grammars

Grammars were introduced in Section 2.2 to systematically describe the syntax of programming language constructs like expressions and statements. Using a syntactic variable *stmt* to denote statements and variable *expr* to denote expressions, the production

$$stmt \rightarrow \text{if } ( expr ) stmt \text{ else } stmt \quad (4.4)$$

specifies the structure of this form of conditional statement. Other productions then define precisely what an *expr* is and what else a *stmt* can be.

This section reviews the definition of a context-free grammar and introduces terminology for talking about parsing. In particular, the notion of derivations is very helpful for discussing the order in which productions are applied during parsing.

### 4.2.1 The Formal Definition of a Context-Free Grammar

From Section 2.2, a context-free grammar (grammar for short) consists of terminals, nonterminals, a start symbol, and productions.

1. *Terminals* are the basic symbols from which strings are formed. The term "token name" is a synonym for "terminal" and frequently we will use the word "token" for terminal when it is clear that we are talking about just the token name. We assume that the terminals are the first components of the tokens output by the lexical analyzer. In (4.4), the terminals are the keywords *if* and *else* and the symbols "(" and ")."
2. *Nonterminals* are syntactic variables that denote sets of strings. In (4.4), *stmt* and *expr* are nonterminals. The sets of strings denoted by nonterminals help define the language generated by the grammar. Nonterminals impose a hierarchical structure on the language that is key to syntax analysis and translation.
3. In a grammar, one nonterminal is distinguished as the *start symbol*, and the set of strings it denotes is the language generated by the grammar. Conventionally, the productions for the start symbol are listed first.
4. The productions of a grammar specify the manner in which the terminals and nonterminals can be combined to form strings. Each *production* consists of:
  - (a) A nonterminal called the *head* or *left side* of the production; this production defines some of the strings denoted by the head.
  - (b) The symbol  $\rightarrow$ . Sometimes  $:=$  has been used in place of the arrow.
  - (c) A *body* or *right side* consisting of zero or more terminals and nonterminals. The components of the body describe one way in which strings of the nonterminal at the head can be constructed.

Example 4.5: The grammar in Fig. 4.2 defines simple arithmetic expressions. In this grammar, the terminal symbols are

**id** + - \* / ( )

The nonterminal symbols are *expression*, *term* and *factor*, and *expression* is the start symbol •

<i>expression</i>	->	<i>expression</i> + <i>term</i>
<i>expression</i>	->	<i>expression</i> - <i>term</i>
<i>expression</i>	->	<i>term</i>
<i>term</i>	->	<i>term</i> * <i>factor</i>
<i>term</i>	->	<i>term</i> / <i>factor</i>
<i>term</i>	->	<i>factor</i>
<i>factor</i>	->	( <i>expression</i> )
<i>factor</i>	->	<b>id</b>

Figure 4.2: Grammar for simple arithmetic expressions

## 4.2.2 Notational Conventions

To avoid always having to state that "these are the terminals," "these are the nonterminals," and so on, the following notational conventions for grammars will be used throughout the remainder of this book.

1. These symbols are terminals:
  - (a) Lowercase letters early in the alphabet, such as *a*, *b*, *c*.
  - (b) Operator symbols such as +, \*, and so on.
  - (c) Punctuation symbols such as parentheses, comma, and so on.
  - (d) The digits 0, 1, ..., 9.
  - (e) Boldface strings such as **id** or **if**, each of which represents a single terminal symbol.
2. These symbols are nonterminals:
  - (a) Uppercase letters early in the alphabet, such as *A*, *B*, *C*.
  - (b) The letter *S*, which, when it appears, is usually the start symbol.
  - (c) Lowercase, italic names such as *expr* or *stmt*.
  - (d) When discussing programming constructs, uppercase letters may be used to represent nonterminals for the constructs. For example, nonterminals for expressions, terms, and factors are often represented by *E*, *T*, and *F*, respectively.

3. Uppercase letters late in the alphabet, such as X, Y, Z, represent *grammar symbols*; that is, either nonterminals or terminals.
4. Lowercase letters late in the alphabet, chiefly u, v, ..., z, represent (possibly empty) strings of terminals.
5. Lowercase Greek letters,  $\alpha, \beta, \gamma$  for example, represent (possibly empty) strings of grammar symbols. Thus, a generic production can be written as  $A \rightarrow \alpha$ , where  $A$  is the head and  $\alpha$  the body.
6. A set of productions  $A \rightarrow \alpha_1, A \rightarrow \alpha_2, \dots, A \rightarrow \alpha_n$  with a common head  $A$  (call them *A-productions*), may be written  $A \rightarrow \alpha_1 \mid \alpha_2 \mid \dots \mid \alpha_n$ . Call  $\alpha_1, \alpha_2, \dots, \alpha_n$  the *alternatives* for  $A$ .
7. Unless stated otherwise, the head of the first production is the start symbol.

Example 4.6: Using these conventions, the grammar of Example 4.5 can be rewritten concisely as

$$\begin{aligned} E &\rightarrow E + T \mid E - T \mid T \\ T &\rightarrow T * F \mid T / F \mid F \\ F &\rightarrow (E) \mid \text{id} \end{aligned}$$

The notational conventions tell us that  $E, T,$  and  $F$  are nonterminals, with  $E$  the start symbol. The remaining symbols are terminals. •

### 4.2.3 Derivations

The construction of a parse tree can be made precise by taking a derivational view, in which productions are treated as rewriting rules. Beginning with the start symbol, each rewriting step replaces a nonterminal by the body of one of its productions. This derivational view corresponds to the top-down construction of a parse tree, but the precision afforded by derivations will be especially helpful when bottom-up parsing is discussed. As we shall see, bottom-up parsing is related to a class of derivations known as "rightmost" derivations, in which the rightmost nonterminal is rewritten at each step.

For example, consider the following grammar, with a single nonterminal  $E$ , which adds a production  $E \rightarrow -E$  to the grammar (4.3):

$$E \rightarrow E + E \mid E * E \mid -E \mid (E) \mid \text{id} \quad (4.7)$$

The production  $E \rightarrow -E$  signifies that if  $E$  denotes an expression, then  $-E$  must also denote an expression. The replacement of a single  $E$  by  $-E$  will be described by writing

$$E \rightarrow -E$$

which is read, " $E$  derives  $-E$ ." The production  $E \rightarrow (E)$  can be applied to replace any instance of  $E$  in any string of grammar symbols by  $(E)$ , e.g.,  $E^*E \rightarrow (E)^*E$  or  $E^*E \rightarrow E^*(E)$ . We can take a single  $E$  and repeatedly apply productions in any order to get a sequence of replacements. For example,

$$E \Rightarrow -E \Rightarrow -(E) \Rightarrow \dots \Rightarrow \mathbf{-(id)}$$

We call such a sequence of replacements a *derivation* of  $\mathbf{-(id)}$  from  $E$ . This derivation provides a proof that the string  $\mathbf{-(id)}$  is one particular instance of an expression.

For a general definition of derivation, consider a nonterminal  $A$  in the middle of a sequence of grammar symbols, as in  $aA\beta$ , where  $a$  and  $\beta$  are arbitrary strings of grammar symbols. Suppose  $A \rightarrow \gamma$  is a production. Then, we write  $aA\beta \Rightarrow a\gamma\beta$ . The symbol  $\Rightarrow$  means, "derives in one step." When a sequence of derivation steps  $a_1 \Rightarrow a_2 \Rightarrow \dots \Rightarrow a_n$  rewrites  $a_1$  to  $a_n$ , we say  $a_1$  derives  $a_n$ . Often, we wish to say, "derives in zero or more steps." For this purpose, we can use the symbol  $\Rightarrow^*$ . Thus,

1.  $a \Rightarrow^* a$ , for any string  $a$ , and
2. If  $a \Rightarrow^* \beta$  and  $\beta \rightarrow \gamma$ , then  $a \Rightarrow^* \gamma$ .

Likewise,  $\Rightarrow^+$  means, "derives in one or more steps."

If  $S \Rightarrow^+ a$ , where  $S$  is the start symbol of a grammar  $G$ , we say that  $a$  is a *sentential form* of  $G$ . Note that a sentential form may contain both terminals and nonterminals, and may be empty. A *sentence* of  $G$  is a sentential form with no nonterminals. The *language generated* by a grammar is its set of sentences. Thus, a string of terminals  $w$  is in  $L(G)$ , the language generated by  $G$ , if and only if  $w$  is a sentence of  $G$  (or  $S \Rightarrow^+ w$ ). A language that can be generated by a grammar is said to be a *context-free language*. If two grammars generate the same language, the grammars are said to be *equivalent*.

The string  $\mathbf{-(id + id)}$  is a sentence of grammar (4.7) because there is a derivation

$$E \Rightarrow -E \Rightarrow -(E) \Rightarrow -(E + E) \Rightarrow \mathbf{-(id + E)} \Rightarrow \mathbf{-(id + id)} \quad (4.8)$$

The strings  $E, -E, -(E), \dots, \mathbf{-(id + id)}$  are all sentential forms of this grammar. We write  $E \Rightarrow^+ \mathbf{-(id + id)}$  to indicate that  $\mathbf{-(id + id)}$  can be derived from  $E$ .

At each step in a derivation, there are two choices to be made. We need to choose which nonterminal to replace, and having made this choice, we must pick a production with that nonterminal as head. For example, the following alternative derivation of  $\mathbf{-(id + id)}$  differs from derivation (4.8) in the last two steps:

$$E \Rightarrow -E \Rightarrow -(E) \Rightarrow -(E + E) \Rightarrow -(E + \mathbf{id}) \Rightarrow \mathbf{-(id + id)} \quad (4.9)$$

Each nonterminal is replaced by the same body in the two derivations, but the order of replacements is different.

To understand how parsers work, we shall consider derivations in which the nonterminal to be replaced at each step is chosen as follows:

1. In *leftmost* derivations, the leftmost nonterminal in each sentential is always chosen. If  $a$  is a step in which the leftmost nonterminal in  $a$  is replaced, we write  $a \xrightarrow{lm}$ .
2. In *rightmost* derivations, the rightmost nonterminal is always chosen; we write  $a \xrightarrow{rm}$  (3 in this case).

Derivation (4.8) is leftmost, so it can be rewritten as

$$E \xrightarrow{lm} \cdot -E \xrightarrow{lm} -(E) \xrightarrow{lm} -(E + E) \xrightarrow{lm} -(id + E) \xrightarrow{lm} -(id + id)$$

Note that (4.9) is a rightmost derivation.

Using our notational conventions, every leftmost step can be written as  $wAj \xrightarrow{lm} w\delta y$ , where  $w$  consists of terminals only,  $A \rightarrow S$  is the production applied, and  $\gamma$  is a string of grammar symbols. To emphasize that  $a$  derives (3 by a leftmost derivation, we write  $a \xrightarrow{lm}$  (3. If  $S \xrightarrow{lm} a$ , then we say that  $a$  is a *left-sentential form* of the grammar at hand.

Analogous definitions hold for rightmost derivations. Rightmost derivations are sometimes called *canonical* derivations.

### 4.2.4 Parse Trees and Derivations

A parse tree is a graphical representation of a derivation that filters out the order in which productions are applied to replace nonterminals. Each interior node of a parse tree represents the application of a production. The interior node is labeled with the nonterminal  $A$  in the head of the production; the children of the node are labeled, from left to right, by the symbols in the body of the production by which this  $A$  was replaced during the derivation.

For example, the parse tree for  $-(id + id)$  in Fig. 4.3, results from the derivation (4.8) as well as derivation (4.9).

The leaves of a parse tree are labeled by nonterminals or terminals and, read from left to right, constitute a sentential form, called the *yield* or *frontier* of the tree.

To see the relationship between derivations and parse trees, consider any derivation  $a_1 \cdot \dots \cdot a_n$ , where  $a_i$  is a single nonterminal  $A$ . For each sentential form  $at$  in the derivation, we can construct a parse tree whose yield is  $at$ . The process is an induction on  $i$ .

**BASIS:** The tree for  $a \setminus = A$  is a single node labeled  $A$ .

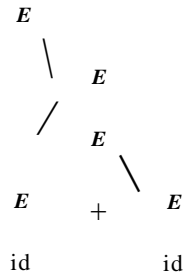

Figure 4.3: Parse tree for  $-(id + id)$ 

**INDUCTION:** Suppose we already have constructed a parse tree with yield  $a_i-1 = X_1X_2 \cdots X_k$  (note that according to our notational conventions, each grammar symbol  $X_j$  is either a nonterminal or a terminal). Suppose  $on$  is derived from  $a_{j+1}$  by replacing  $X_j$ , a nonterminal, by  $\beta = Y_1 \cdots Y_m$ . That is, at the  $i$ th step of the derivation, production  $X_j \rightarrow \beta$  is applied to  $a_i$  to derive  $a_i = X_1 \cdots X_{j-1} \beta X_{j+1} \cdots X_k$ .

To model this step of the derivation, find the  $j$ 'th leaf from the left in the current parse tree. This leaf is labeled  $X_j$ . Give this leaf  $m$  children, labeled  $Y_1, Y_2, \dots, Y_m$ , from the left. As a special case, if  $m = 0$ , then  $\beta = \epsilon$ , and we give the  $j$ th leaf one child labeled  $\epsilon$ .

Example 4.10: The sequence of parse trees constructed from the derivation (4.8) is shown in Fig. 4.4. In the first step of the derivation,  $E \rightarrow -E$ . To model this step, add two children, labeled  $-$  and  $E$ , to the root  $E$  of the initial tree. The result is the second tree.

In the second step of the derivation,  $-E \rightarrow -(E)$ . Consequently, add three children, labeled  $($ ,  $E$ , and  $)$ , to the leaf labeled  $E$  of the second tree, to obtain the third tree with yield  $-(E)$ . Continuing in this fashion we obtain the complete parse tree as the sixth tree. •

Since a parse tree ignores variations in the order in which symbols in sentential forms are replaced, there is a many-to-one relationship between derivations and parse trees. For example, both derivations (4.8) and (4.9), are associated with the same final parse tree of Fig. 4.4.

In what follows, we shall frequently parse by producing a leftmost or a rightmost derivation, since there is a one-to-one relationship between parse trees and either leftmost or rightmost derivations. Both leftmost and rightmost derivations pick a particular order for replacing symbols in sentential forms, so they too filter out variations in the order. It is not hard to show that every parse tree has associated with it a unique leftmost and a unique rightmost derivation.

$$E \Rightarrow E \Rightarrow E$$

$$- \quad \#$$

$$\left( \begin{array}{c} / \mathbf{1} \backslash \\ E \end{array} \right)$$

$$\begin{array}{ccc} \begin{array}{c} / \mathbf{I} \backslash \\ ( B ) \\ / \mathbf{I} \mathbf{V} \\ E + E \end{array} & \begin{array}{c} / \mathbf{1} \backslash \\ ( \mathcal{E} ) \\ / \mathbf{1} \backslash \\ E + E \\ \mathbf{id} \end{array} & \begin{array}{c} / \mathbf{1} \backslash \\ ( E ) \\ / \mathbf{1} \backslash \\ E + E \\ \mathbf{id} \quad \mathbf{id} \end{array} \end{array}$$

Figure 4.4: Sequence of parse trees for derivation (4.8)

### 4.2.5 Ambiguity

From Section 2.2.4, a grammar that produces more than one parse tree for some sentence is said to be *ambiguous*. Put another way, an ambiguous grammar is one that produces more than one leftmost derivation or more than one rightmost derivation for the same sentence.

**Example 4.11:** The arithmetic expression grammar (4.3) permits two distinct leftmost derivations for the sentence **id + id \* id**:

$$\begin{array}{l} E \Rightarrow E + E \Rightarrow id + E \Rightarrow id + E * E \Rightarrow id + id * E \Rightarrow id + id * id \\ E \Rightarrow E * E \Rightarrow E + E * E \Rightarrow id + id * E \Rightarrow id + id * id \end{array}$$

The corresponding parse trees appear in Fig. 4.5.

Note that the parse tree of Fig. 4.5(a) reflects the commonly assumed precedence of + and \*, while the tree of Fig. 4.5(b) does not. That is, it is customary to treat operator \* as having higher precedence than +, corresponding to the fact that we would normally evaluate an expression like  $a + b * c$  as  $a + (b * c)$ , rather than as  $(a + b) * c$ .

For most parsers, it is desirable that the grammar be made unambiguous, for if it is not, we cannot uniquely determine which parse tree to select for a sentence. In other cases, it is convenient to use carefully chosen ambiguous grammars, together with *disambiguating rules* that "throw away" undesirable parse trees, leaving only one tree for each sentence.

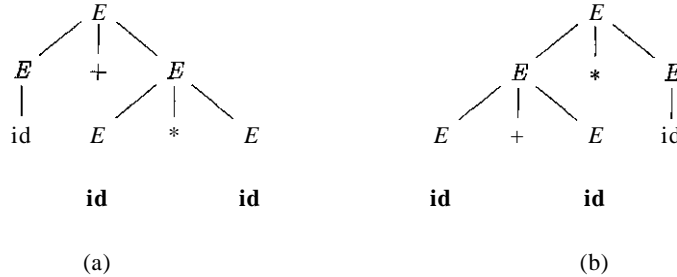
Figure 4.5: Two parse trees for  $\text{id+id*id}$ 

## 4.2.6 Verifying the Language Generated by a Grammar

Although compiler designers rarely do so for a complete programming-language grammar, it is useful to be able to reason that a given set of productions generates a particular language. Troublesome constructs can be studied by writing a concise, abstract grammar and studying the language that it generates. We shall construct such a grammar for conditional statements below.

A proof that a grammar  $G$  generates a language  $L$  has two parts: show that every string generated by  $G$  is in  $L$ , and conversely that every string in  $L$  can indeed be generated by  $G$ .

Example 4.12: Consider the following grammar:

$$S \rightarrow (S) S \mid \epsilon \quad (4.13)$$

It may not be initially apparent, but this simple grammar generates all strings of balanced parentheses, and only such strings. To see why, we shall show first that every sentence derivable from  $S$  is balanced, and then that every balanced string is derivable from  $S$ . To show that every sentence derivable from  $S$  is balanced, we use an inductive proof on the number of steps  $n$  in a derivation.

**BASIS:** The basis is  $n = 1$ . The only string of terminals derivable from  $S$  in one step is the empty string, which surely is balanced.

**INDUCTION:** Now assume that all derivations of fewer than  $n$  steps produce balanced sentences, and consider a leftmost derivation of exactly  $n$  steps. Such a derivation must be of the form

$$\underset{lm}{(S)S^n} \quad \underset{lm}{(x)S^n} \quad \underset{lm}{(x)y}$$

The derivations of  $x$  and  $y$  from  $S$  take fewer than  $n$  steps, so by the inductive hypothesis  $x$  and  $y$  are balanced. Therefore, the string  $(x)y$  must be balanced. That is, it has an equal number of left and right parentheses, and every prefix has at least as many left parentheses as right.

Having thus shown that any string derivable from  $S$  is balanced, we must next show that every balanced string is derivable from  $S$ . To do so, use induction on the length of a string.

**BASIS:** If the string is of length 0, it must be  $e$ , which is balanced.

**INDUCTION:** First, observe that every balanced string has even length. Assume that every balanced string of length less than  $2n$  is derivable from  $S$ , and consider a balanced string  $w$  of length  $2n$ ,  $n > 1$ . Surely  $w$  begins with a left parenthesis. Let  $(x)$  be the shortest nonempty prefix of  $w$  having an equal number of left and right parentheses. Then  $w$  can be written as  $w = (x)y$  where both  $x$  and  $y$  are balanced. Since  $x$  and  $y$  are of length less than  $2n$ , they are derivable from  $S$  by the inductive hypothesis. Thus, we can find a derivation of the form

$$S \Rightarrow (S)S \Rightarrow (x)S \Rightarrow (x)y$$

proving that  $w = (x)y$  is also derivable from  $S$ . •

## 4.2.7 Context-Free Grammars Versus Regular Expressions

Before leaving this section on grammars and their properties, we establish that grammars are a more powerful notation than regular expressions. Every construct that can be described by a regular expression can be described by a grammar, but not vice-versa. Alternatively, every regular language is a context-free language, but not vice-versa.

For example, the regular expression  $(a|b)^*abb$  and the grammar

$$\begin{array}{l} A_0 \rightarrow aA_0 \quad \text{I} \quad bA_0 \\ A_i \rightarrow * \quad bA_i \\ A_i \rightarrow bA_i \\ A_i \rightarrow e \end{array}$$

describe the same language, the set of strings of a's and b's ending in  $abb$ .

We can construct mechanically a grammar to recognize the same language as a nondeterministic finite automaton (NFA). The grammar above was constructed from the NFA in Fig. 3.24 using the following construction:

1. For each state  $i$  of the NFA, create a nonterminal  $A_i$ .
2. If state  $i$  has a transition to state  $j$  on input  $a$ , add the production  $A_i \rightarrow aA_j$ . If state  $i$  goes to state  $j$  on input  $e$ , add the production  $A_i \rightarrow A_j$ .
3. If  $H$  is an accepting state, add  $A_H \rightarrow e$ .
4. If  $i$  is the start state, make  $A_i$  be the start symbol of the grammar.

On the other hand, the language  $L = \{a^n b^n \mid n > 1\}$  with an equal number of a's and b's is a prototypical example of a language that can be described by a grammar but not by a regular expression. To see why, suppose  $L$  were the language defined by some regular expression. We could construct a DFA  $D$  with a finite number of states, say  $k$ , to accept  $L$ . Since  $D$  has only  $k$  states, for an input beginning with more than  $k$  a's,  $D$  must enter some state twice, say  $S_i$ , as in Fig. 4.6. Suppose that the path from  $S_i$  back to itself is labeled with a sequence  $a^i b^i$ . Since  $a^i b^i$  is in the language, there must be a path labeled  $b^i$  from  $S_i$  to an accepting state  $f$ . But, then there is also a path from the initial state  $s_0$  through  $S_i$  to  $f$  labeled  $a^i b^i$ , as shown in Fig. 4.6. Thus,  $D$  also accepts  $a^i b^i$ , which is not in the language, contradicting the assumption that  $L$  is the language accepted by  $D$ .

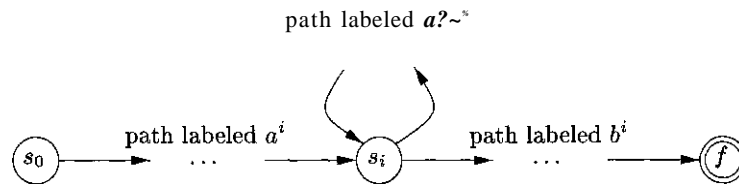

Figure 4.6: DFA  $D$  accepting both  $a^i b^i$  and  $a^i b^i$ .

Colloquially, we say that "finite automata cannot count," meaning that a finite automaton cannot accept a language like  $\{a^n b^n \mid n > 1\}$  that would require it to keep count of the number of a's before it sees the b's. Likewise, "a grammar can count two items but not three," as we shall see when we consider non-context-free language constructs in Section 4.3.5.

## 4.2.8 Exercises for Section 4.2

**Exercise 4.2.1:** Consider the context-free grammar:

$$S \rightarrow S S + \mid S S * \mid a$$

and the string  $aa + a^*$ .

- Give a leftmost derivation for the string.
- Give a rightmost derivation for the string.
- Give a parse tree for the string.
- ! Is the grammar ambiguous or unambiguous? Justify your answer.
- ! Describe the language generated by this grammar.

**Exercise 4.2.2:** Repeat Exercise 4.2.1 for each of the following grammars and strings:

- a)  $S \rightarrow 0^5 1 \mid 0^1 1$  with string 000111.
- b)  $S \rightarrow + \mid 5 \mid S \mid S / a$  with string  $+ * aaa$ .
- !c)  $S \rightarrow S (S) S \mid \epsilon$  with string  $((()))$ .
- !d)  $S \rightarrow S + S \mid S(S)S \mid * \mid a$  with string  $(a + a) * a$ .
- !e)  $S \rightarrow (L) \mid a$  and  $L \rightarrow L, \mid 5 \mid 5$  with string  $((a,a),a,(a))$ .
- !! f)  $S \rightarrow a^5 6^5 \mid \& \mid 5^5 a^5 \mid \epsilon$  with string  $aabbab$ .

The following grammar for boolean expressions:

$$\begin{aligned} bexpr &\rightarrow \text{true} \mid \text{false} \mid \text{not } bfactor \mid ( bexpr ) \\ bfactor &\rightarrow bterm \mid bfactor \text{ and } bfactor \mid bfactor \text{ or } bfactor \end{aligned}$$

**Exercise 4.2.3:** Design grammars for the following languages:

- a) The set of all strings of 0s and 1s such that every 0 is immediately followed by at least one 1.
- ! b) The set of all strings of 0s and 1s that are *palindromes*; that is, the string reads the same backward as forward.
- ! c) The set of all strings of 0s and 1s with an equal number of 0s and 1s.
- !! d) The set of all strings of 0s and 1s with an unequal number of 0s and 1s.
- ! e) The set of all strings of 0s and 1s in which 011 does not appear as a substring.
- !! f) The set of all strings of 0s and 1s of the form  $xy$ , where  $x \neq y$  and  $x$  and  $y$  are of the same length.

**Exercise 4.2.4:** There is an extended grammar notation in common use. In this notation, square and curly braces in production bodies are metasyms (like  $\rightarrow$  or  $\mid$ ) with the following meanings:

- i) Square braces around a grammar symbol or symbols denotes that these constructs are optional. Thus, production  $A \rightarrow X [Y] Z$  has the same effect as the two productions  $A \rightarrow X Y Z$  and  $A \rightarrow X Z$ .
- ii) Curly braces around a grammar symbol or symbols says that these symbols may be repeated any number of times, including zero times. Thus,  $A \rightarrow X \{Y\} Z$  has the same effect as the infinite sequence of productions  $A \rightarrow X, A \rightarrow XY, A \rightarrow XYZ, A \rightarrow XYZY, \dots$  and so on.

Show that these two extensions do not add power to grammars; that is, any language that can be generated by a grammar with these extensions can be generated by a grammar without the extensions.

**Exercise 4.2.5:** Use the braces described in Exercise 4.2.4 to simplify the following grammar for statement blocks and conditional statements:

```

stmt      -> if expr then stmt else stmt
           | if stmt then stmt
           | begin stmtList end
stmtList -> stmt; stmtList | stmt

```

**! Exercise 4.2.6:** Extend the idea of Exercise 4.2.4 to allow any regular expression of grammar symbols in the body of a production. Show that this extension does not allow grammars to define any new languages.

**! Exercise 4.2.7:** A grammar symbol  $X$  (terminal or nonterminal) is *useless* if there is no derivation of the form  $S \Rightarrow wXy \Rightarrow wxy$ . That is,  $X$  can never appear in the derivation of any sentence.

- Give an algorithm to eliminate from a grammar all productions containing useless symbols.
- Apply your algorithm to the grammar:

```

S  -> 0 | A
A  -> AB
B  -> 1

```

**Exercise 4.2.8:** The grammar in Fig. 4.7 generates declarations for a single numerical identifier; these declarations involve four different, independent properties of numbers.

```

stmt      declare id optionList
optionList optionList option \ e
option     -> mode | scale | precision | base
mode      -> real | complex
scale     -> fixed | floating
precision -> single | double
base      -> binary | decimal

```

Figure 4.7: A grammar for multi-attribute declarations

- Generalize the grammar of Fig. 4.7 by allowing  $n$  options  $A_i$ , for some fixed  $n$  and for  $i = 1, 2, \dots, n$ , where  $A_i$  can be either  $a_i$  or  $b_i$ . Your grammar should use only  $O(n)$  grammar symbols and have a total length of productions that is  $O(n)$ .

- ! b) The grammar of Fig. 4.7 and its generalization in part (a) allow declarations that are contradictory and/or redundant, such as:

```
declare foo real fixed real floating
```

We could insist that the syntax of the language forbid such declarations; that is, every declaration generated by the grammar has exactly one value for each of the  $n$  options. If we do, then for any fixed  $n$  there is only a finite number of legal declarations. The language of legal declarations thus has a grammar (and also a regular expression), as any finite language does. The obvious grammar, in which the start symbol has a production for every legal declaration has  $n!$  productions and a total production length of  $O(n \times n!)$ . You must do better: a total production length that is  $O(n2^n)$ .

- !! c) Show that any grammar for part (b) must have a total production length of at least  $2^n$ .
- d) What does part (c) say about the feasibility of enforcing nonredundancy and noncontradiction among options in declarations via the syntax of the programming language?

## 4.3 Writing a Grammar

Grammars are capable of describing most, but not all, of the syntax of programming languages. For instance, the requirement that identifiers be declared before they are used, cannot be described by a context-free grammar. Therefore, the sequences of tokens accepted by a parser form a superset of the programming language; subsequent phases of the compiler must analyze the output of the parser to ensure compliance with rules that are not checked by the parser.

This section begins with a discussion of how to divide work between a lexical analyzer and a parser. We then consider several transformations that could be applied to get a grammar more suitable for parsing. One technique can eliminate ambiguity in the grammar, and other techniques — left-recursion elimination and left factoring — are useful for rewriting grammars so they become suitable for top-down parsing. We conclude this section by considering some programming language constructs that cannot be described by any grammar.

### 4.3.1 Lexical Versus Syntactic Analysis

As we observed in Section 4.2.7, everything that can be described by a regular expression can also be described by a grammar. We may therefore reasonably ask: "Why use regular expressions to define the lexical syntax of a language?" There are several reasons.



1. Separating the syntactic structure of a language into lexical and non-lexical parts provides a convenient way of modularizing the front end of a compiler into two manageable-sized components.
2. The lexical rules of a language are frequently quite simple, and to describe them we do not need a notation as powerful as grammars.
3. Regular expressions generally provide a more concise and easier-to-understand notation for tokens than grammars.
4. More efficient lexical analyzers can be constructed automatically from regular expressions than from arbitrary grammars.

There are no firm guidelines as to what to put into the lexical rules, as opposed to the syntactic rules. Regular expressions are most useful for describing the structure of constructs such as identifiers, constants, keywords, and white space. Grammars, on the other hand, are most useful for describing nested structures such as balanced parentheses, matching begin-end's, corresponding if-then-else's, and so on. These nested structures cannot be described by regular expressions.

### 4.3.2 Eliminating Ambiguity

Sometimes an ambiguous grammar can be rewritten to eliminate the ambiguity. As an example, we shall eliminate the ambiguity from the following "dangling-else" grammar:

$$\begin{array}{lcl}
 stmt & \longrightarrow & \mathbf{if\ } expr \mathbf{\ then\ } stmt \\
 & & | \quad \mathbf{if\ } expr \mathbf{\ then\ } stmt \mathbf{\ else\ } stmt \\
 & & | \quad \mathbf{other}
 \end{array} \tag{4.14}$$

Here "**other**" stands for any other statement. According to this grammar, the compound conditional statement

**if  $E_1$  then  $S_1$  else if  $E_2$  then  $S_2$  else  $S_3$**

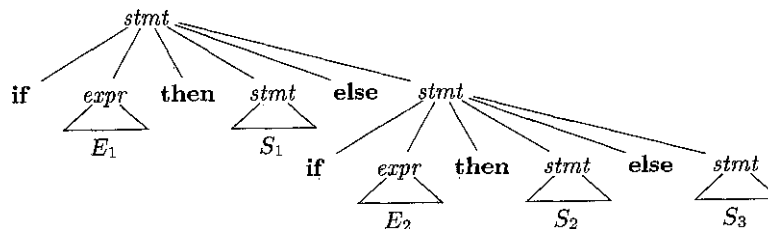

Figure 4.8: Parse tree for a conditional statement

has the parse tree shown in Fig. 4.8.<sup>1</sup> Grammar (4.14) is ambiguous since the string

$$\mathbf{if } E_1 \mathbf{ then if } E_2 \mathbf{ then } S_i \mathbf{ else } S_j \quad (4.15)$$

has the two parse trees shown in Fig. 4.9.

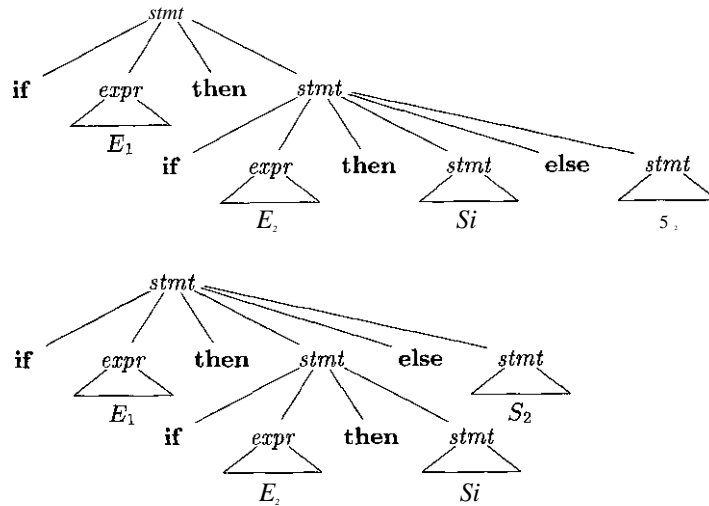

Figure 4.9: Two parse trees for an ambiguous sentence

In all programming languages with conditional statements of this form, the first parse tree is preferred. The general rule is, "Match each **else** with the closest unmatched **then**."<sup>2</sup> This disambiguating rule can theoretically be incorporated directly into a grammar, but in practice it is rarely built into the productions.

**Example 4.16:** We can rewrite the dangling-else grammar (4.14) as the following unambiguous grammar. The idea is that a statement appearing between a **then** and an **else** must be "matched"; that is, the interior statement must not end with an unmatched or open **then**. A matched statement is either an **if-then-else** statement containing no open statements or it is any other kind of unconditional statement. Thus, we may use the grammar in Fig. 4.10. This grammar generates the same strings as the dangling-else grammar (4.14), but it allows only one parsing for string (4.15); namely, the one that associates each **else** with the closest previous unmatched **then**. •

<sup>1</sup>The subscripts on  $E$  and  $S$  are just to distinguish different occurrences of the same nonterminal, and do not imply distinct nonterminals.

<sup>2</sup>We should note that  $C$  and its derivatives are included in this class. Even though the  $C$  family of languages do not use the keyword **then**, its role is played by the closing parenthesis for the condition that follows **if**.

```

      stmt    ->    matchedstmt
              /
              openstmt
matchedstmt ->    if expr then matchedstmt else matchedstmt
              |
              other
openstmt   ->    if expr then stmt
              |
              if expr then matchedstmt else openstmt

```

Figure 4.10: Unambiguous grammar for if-then-else statements

### 4.3.3 Elimination of Left Recursion

A grammar is *left recursive* if it has a nonterminal  $A$  such that there is a derivation  $A \Rightarrow^+ Aa$  for some string  $a$ . Top-down parsing methods cannot handle left-recursive grammars, so a transformation is needed to eliminate left recursion. In Section 2.4.5, we discussed *immediate left recursion*, where there is a production of the form  $A \Rightarrow^+ Aa$ . Here, we study the general case. In Section 2.4.5, we showed how the left-recursive pair of productions  $A \Rightarrow^+ Aa \mid ft$  could be replaced by the non-left-recursive productions:

$$\begin{aligned}
 A &\rightarrow aA' \\
 A' &\rightarrow aA' \mid e
 \end{aligned}$$

without changing the strings derivable from  $A$ . This rule by itself suffices for many grammars.

**Example 4.17:** The non-left-recursive expression grammar (4.2), repeated here,

$$\begin{aligned}
 E &\rightarrow T E' \\
 E' &\rightarrow + T E' \\
 T &\rightarrow FT' \\
 T' &\rightarrow * F T \\
 F &\rightarrow (E) \mid \text{id}
 \end{aligned}$$

is obtained by eliminating immediate left recursion from the expression grammar (4.1). The left-recursive pair of productions  $E \Rightarrow^+ E + T \mid T$  are replaced by  $E \rightarrow T E'$  and  $E' \Rightarrow^+ + T E' \mid e$ . The new productions for  $T$  and  $T'$  are obtained similarly by eliminating immediate left recursion. •

Immediate left recursion can be eliminated by the following technique, which works for any number of  $A$ -productions. First, group the productions as

$$A \rightarrow A_n \mid Aa_1 \mid \dots \mid Aa_n \mid (3 \mid \text{ft} \mid \dots \mid /3,$$

where no  $ft$  begins with an  $A$ . Then, replace the  $A$ -productions by

$$A' \rightarrow a_1 A' \mid a_2 A' \mid \dots \mid a_n A' \mid \epsilon$$

The nonterminal  $A$  generates the same strings as before but is no longer left recursive. This procedure eliminates all left recursion from the  $A$  and  $A'$  productions (provided no  $A \rightarrow \epsilon$ ), but it does not eliminate left recursion involving derivations of two or more steps. For example, consider the grammar

$$A \rightarrow A c \mid S d \mid \epsilon$$

The nonterminal  $S$  is left recursive because  $S \rightarrow Aa \rightarrow Sda$ , but it is not immediately left recursive.

Algorithm 4.19, below, systematically eliminates left recursion from a grammar. It is guaranteed to work if the grammar has no cycles (derivations of the form  $A \rightarrow A$ ) or  $\epsilon$ -productions (productions of the form  $A \rightarrow \epsilon$ ). Cycles can be eliminated systematically from a grammar, as can  $\epsilon$ -productions (see Exercises 4.4.6 and 4.4.7).

Algorithm 4.19: Eliminating left recursion.

**INPUT:** Grammar  $G$  with no cycles or  $\epsilon$ -productions.

**OUTPUT:** An equivalent grammar with no left recursion.

**METHOD:** Apply the algorithm in Fig. 4.11 to  $G$ . Note that the resulting non-left-recursive grammar may have  $\epsilon$ -productions. •

- 1) arrange the nonterminals in some order  $A_1, A_2, \dots, A_n$ .
- 2) for ( each  $i$  from 1 to  $n$  ) {
- 3)     for ( each  $j$  from 1 to  $i - 1$  ) {
- 4)         replace each production of the form  $A_i \rightarrow A_j \alpha$  by the  
           productions  $A_i \rightarrow S_i \mid S_2 \mid \dots \mid S_k$ , where  
            $A_j \rightarrow S_i \mid S_2 \mid \dots \mid S_k$  are all current  $A_j$ -productions
- 5)     }
- 6)     eliminate the immediate left recursion among the  $A_i$ -productions
- 7) }

Figure 4.11: Algorithm to eliminate left recursion from a grammar

The procedure in Fig. 4.11 works as follows. In the first iteration for  $i = 1$ , the outer for-loop of lines (2) through (7) eliminates any immediate left recursion among  $A_1$ -productions. Any remaining  $A_1$  productions of the form  $A_1 \rightarrow A_1 a$  must therefore have  $|a| > 1$ . After the  $i - 1$ st iteration of the outer for-loop, all nonterminals  $A_k$ , where  $k < i$ , are "cleaned"; that is, any production  $A_k \rightarrow A_i a$ , must have  $|a| > k$ . As a result, on the  $i$ th iteration, the inner loop

of lines (3) through (5) progressively raises the lower limit in any production  $A_i \rightarrow A_m a$ , until we have  $m > i$ . Then, eliminating immediate left recursion for the  $A_i$  productions at line (6) forces  $m$  to be greater than  $i$ .

**Example 4.20:** Let us apply Algorithm 4.19 to the grammar (4.18). Technically, the algorithm is not guaranteed to work, because of the  $\epsilon$ -production, but in this case, the production  $A \rightarrow \epsilon$  turns out to be harmless.

We order the nonterminals  $S, A$ . There is no immediate left recursion among the 5-productions, so nothing happens during the outer loop for  $i = 1$ . For  $i = 2$ , we substitute for  $S$  in  $A \rightarrow S d$  to obtain the following  $\wedge$ -productions.

$$A \wedge A c \mid A a d \mid b d \mid \epsilon$$

Eliminating the immediate left recursion among these  $\wedge$ -productions yields the following grammar.

$$\begin{aligned} S &\wedge A a \mid b \\ A &\wedge b d A' \mid A' \\ A' &\wedge \epsilon \mid a d A' \end{aligned}$$

•

### 4.3.4 Left Factoring

Left factoring is a grammar transformation that is useful for producing a grammar suitable for predictive, or top-down, parsing. When the choice between two alternative  $\wedge$ -productions is not clear, we may be able to rewrite the productions to defer the decision until enough of the input has been seen that we can make the right choice.

For example, if we have the two productions

$$\begin{aligned} stmt &\rightarrow \bullet \text{ if } expr \text{ then } stmt \text{ else } stmt \\ &\mid \text{ if } expr \text{ then } stmt \end{aligned}$$

on seeing the input **if**, we cannot immediately tell which production to choose to expand  $stmt$ . In general, if  $A \rightarrow \bullet aft \mid aft$  are two  $A$ -productions, and the input begins with a nonempty string derived from  $a$ , we do not know whether to expand  $A$  to  $aft$  or  $aft$ . However, we may defer the decision by expanding  $A$  to  $aA'$ . Then, after seeing the input derived from  $a$ , we expand  $A'$  to  $ft$  or to  $ft$ . That is, left-factored, the original productions become

$$\begin{aligned} A &\rightarrow \bullet aA' \\ A' &\wedge ft \mid ft \end{aligned}$$

**Algorithm 4.21:** Left factoring a grammar.

**INPUT:** Grammar  $G$ .

**OUTPUT:** An equivalent left-factored grammar.

**METHOD:** For each nonterminal  $A$ , find the longest prefix  $a$  common to two or more of its alternatives. If  $a \neq \epsilon$  — i.e., there is a nontrivial common prefix — replace all of the  $A$ -productions  $A \rightarrow \dots | a\alpha | \dots | \alpha$ , where  $\alpha$  represents all alternatives that do not begin with  $a$ , by

$$\begin{aligned} A &\rightarrow aA' \mid \alpha \\ A' &\rightarrow \beta \mid \gamma \mid \delta \end{aligned}$$

Here  $A'$  is a new nonterminal. Repeatedly apply this transformation until no two alternatives for a nonterminal have a common prefix. •

Example 4.22: The following grammar abstracts the "dangling-else" problem:

$$\begin{aligned} S &\rightarrow iEtS \mid iEtSeS \mid a \\ E &\rightarrow b \end{aligned}$$

Here,  $i$ ,  $t$ , and  $e$  stand for if, then, and else;  $E$  and  $S$  stand for "conditional expression" and "statement." Left-factored, this grammar becomes:

$$\begin{aligned} S &\rightarrow iEtSS' \mid a \\ S' &\rightarrow eS \mid e \\ E &\rightarrow b \end{aligned} \tag{4.24}$$

Thus, we may expand  $S$  to  $iEtSS'$  on input  $i$ , and wait until  $i\epsilon tt5$  has been seen to decide whether to expand  $S'$  to  $eS$  or to  $e$ . Of course, these grammars are both ambiguous, and on input  $e$ , it will not be clear which alternative for  $S'$  should be chosen. Example 4.33 discusses a way out of this dilemma. •

### 4.3.5 Non-Context-Free Language Constructs

A few syntactic constructs found in typical programming languages cannot be specified using grammars alone. Here, we consider two of these constructs, using simple abstract languages to illustrate the difficulties.

Example 4.25: The language in this example abstracts the problem of checking that identifiers are declared before they are used in a program. The language consists of strings of the form  $wcw$ , where the first  $w$  represents the declaration of an identifier  $w$ ,  $c$  represents an intervening program fragment, and the second  $w$  represents the use of the identifier.

The abstract language is  $L = \{wcv \mid w \text{ is in } (a|b)^*\}$ .  $L$  consists of all words composed of a repeated string of  $a$ 's and  $b$ 's separated by  $c$ , such as  $aabcaab$ . While it is beyond the scope of this book to prove it, the non-context-freeness of  $L$  directly implies the non-context-freeness of programming languages like C and Java, which require declaration of identifiers before their use and which allow identifiers of arbitrary length.

For this reason, a grammar for C or Java does not distinguish among identifiers that are different character strings. Instead, all identifiers are represented

by a token such as **id** in the grammar. In a compiler for such a language, the semantic-analysis phase checks that identifiers are declared before they are used. •

**Example 4.26:** The non-context-free language in this example abstracts the problem of checking that the number of formal parameters in the declaration of a function agrees with the number of actual parameters in a use of the function. The language consists of strings of the form  $a^n b^m c^n d^m$ . (Recall  $a^n$  means  $a$  written  $n$  times.) Here  $a^n$  and  $b^m$  could represent the formal-parameter lists of two functions declared to have  $n$  and  $m$  arguments, respectively, while  $c^n$  and  $d^m$  represent the actual-parameter lists in calls to these two functions.

The abstract language is  $L_2 = \{a^n b^m c^n d^m \mid n > 1 \text{ and } m > 1\}$ . That is,  $L_2$  consists of strings in the language generated by the regular expression  $\mathbf{a^*b^*c^*d^*}$  such that the number of a's and c's are equal and the number of b's and d's are equal. This language is not context free.

Again, the typical syntax of function declarations and uses does not concern itself with counting the number of parameters. For example, a function call in C-like language might be specified by

$$\begin{array}{ll} \text{stmt} & \rightarrow \mathbf{id} ( \text{exprJist} ) \\ \text{exprJist} & \rightarrow \text{exprJist} , \text{expr} \\ & \mid \text{expr} \end{array}$$

with suitable productions for *expr*. Checking that the number of parameters in a call is correct is usually done during the semantic-analysis phase. •

### 4.3.6 Exercises for Section 4.3

**Exercise 4.3.1:** The following is a grammar for regular expressions over symbols  $a$  and  $b$  only, using  $+$  in place of  $|$  for union, to avoid conflict with the use of vertical bar as a metasymbol in grammars:

$$\begin{array}{ll} \text{rexpr} & \text{rexpr} + \text{rterm} \mid \text{rterm} \\ \text{rterm} & \text{rterm} \text{rfactor} \mid \text{rfactor} \\ \text{rfactor} & \text{rfactor} * \mid \text{rprimary} \\ \text{rprimary} & \mathbf{a} \mid \mathbf{b} \end{array}$$

- Left factor this grammar.
- Does left factoring make the grammar suitable for top-down parsing?
- In addition to left factoring, eliminate left recursion from the original grammar.
- Is the resulting grammar suitable for top-down parsing?

**Exercise 4.3.2:** Repeat Exercise 4.3.1 on the following grammars:

- a) The grammar of Exercise 4.2.1.
- b) The grammar of Exercise 4.2.2(a).
- c) The grammar of Exercise 4.2.2(c).
- d) The grammar of Exercise 4.2.2(e).
- e) The grammar of Exercise 4.2.2(g).

! **Exercise 4.3.3:** The following grammar is proposed to remove the "dangling-else ambiguity" discussed in Section 4.3.2:

$$\begin{array}{ll}
 \textit{stmt} & \rightarrow \text{if } \textit{expr} \text{ then } \textit{stmt} \\
 & \quad | \quad \textit{matchedStmt} \\
 \textit{matchedStmt} & \rightarrow \text{if } \textit{expr} \text{ then } \textit{matchedStmt} \text{ else } \textit{stmt} \\
 & \quad | \quad \text{other}
 \end{array}$$

Show that this grammar is still ambiguous.

## 4.4 Top-Down Parsing

Top-down parsing can be viewed as the problem of constructing a parse tree for the input string, starting from the root and creating the nodes of the parse tree in preorder (depth-first, as discussed in Section 2.3.4). Equivalently, top-down parsing can be viewed as finding a leftmost derivation for an input string.

**Example 4.27:** The sequence of parse trees in Fig. 4.12 for the input **id+id\*id** is a top-down parse according to grammar (4.2), repeated here:

$$\begin{array}{ll}
 E & \rightarrow T E' \\
 E' & \rightarrow + T E' \mathbf{1 c} \\
 T & \rightarrow F V \\
 V & \rightarrow * F \mathbf{r 1 c} \\
 F & \rightarrow (E) \quad | \quad \mathbf{id}
 \end{array}$$

This sequence of trees corresponds to a leftmost derivation of the input. •

At each step of a top-down parse, the key problem is that of determining the production to be applied for a nonterminal, say *A*. Once an *A*-production is chosen, the rest of the parsing process consists of "matching" the terminal symbols in the production body with the input string.

The section begins with a general form of top-down parsing, called recursive-descent parsing, which may require backtracking to find the correct *A*-production to be applied. Section 2.4.2 introduced predictive parsing, a special case of recursive-descent parsing, where no backtracking is required. Predictive parsing chooses the correct *A*-production by looking ahead at the input a fixed number of symbols, typically we may look only at one (that is, the next input symbol).



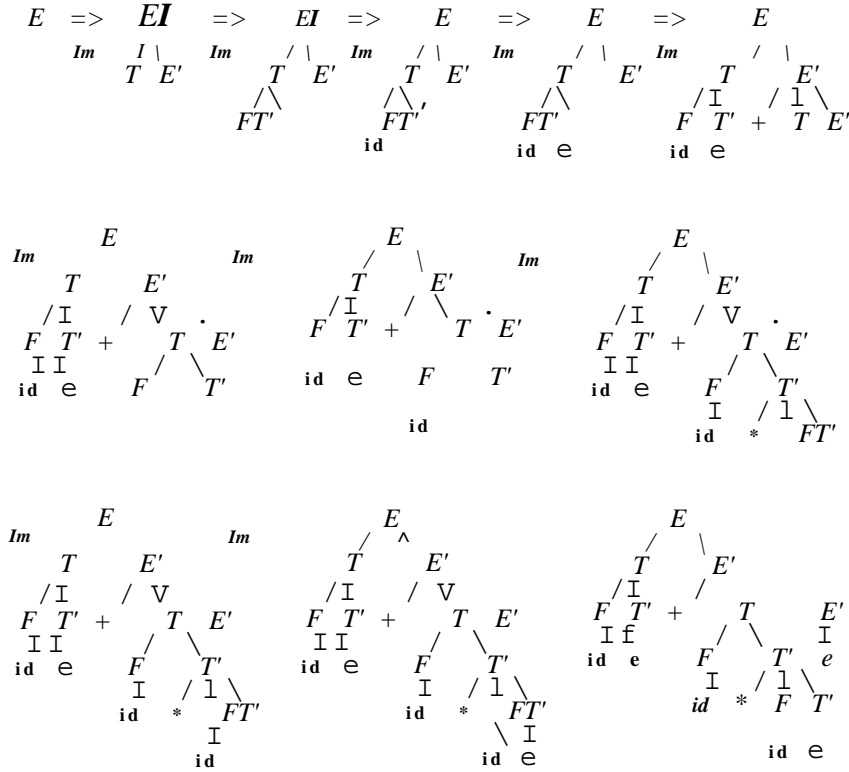

Figure 4.12: Top-down parse for  $id + id * id$

For example, consider the top-down parse in Fig. 4.12, which constructs a tree with two nodes labeled  $E'$ . At the first  $E'$  node (in preorder), the production  $E' \rightarrow +TE'$  is chosen; at the second  $E'$  node, the production  $E' \rightarrow e$  is chosen. A predictive parser can choose between  $E'$ -productions by looking at the next input symbol.

The class of grammars for which we can construct predictive parsers looking  $k$  symbols ahead in the input is sometimes called the  $LL(k)$  class. We discuss the  $LL(1)$  class in Section 4.4.3, but introduce certain computations, called FIRST and FOLLOW, in a preliminary Section 4.4.2. From the FIRST and FOLLOW sets for a grammar, we shall construct "predictive parsing tables," which make explicit the choice of production during top-down parsing. These sets are also useful during bottom-up parsing,

In Section 4.4.4 we give a nonrecursive parsing algorithm that maintains a stack explicitly, rather than implicitly via recursive calls. Finally, in Section 4.4.5 we discuss error recovery during top-down parsing.

### 4.4.1 Recursive-Descent Parsing

```

void A() {
1)   Choose an A-production, A → X1X2...Xk
2)   for ( i = 1 to k ) {
3)       if ( Xi is a nonterminal )
4)           call procedure XiQ;
5)       else if ( Xi equals the current input symbol a )
6)           advance the input to the next symbol;
7)       else /* an error has occurred */;
    }
}

```

Figure 4.13: A typical procedure for a nonterminal in a top-down parser

A recursive-descent parsing program consists of a set of procedures, one for each nonterminal. Execution begins with the procedure for the start symbol, which halts and announces success if its procedure body scans the entire input string. Pseudocode for a typical nonterminal appears in Fig. 4.13. Note that this pseudocode is nondeterministic, since it begins by choosing the A-production to apply in a manner that is not specified.

General recursive-descent may require backtracking; that is, it may require repeated scans over the input. However, backtracking is rarely needed to parse programming language constructs, so backtracking parsers are not seen frequently. Even for situations like natural language parsing, backtracking is not very efficient, and tabular methods such as the dynamic programming algorithm of Exercise 4.4.9 or the method of Earley (see the bibliographic notes) are preferred.

To allow backtracking, the code of Fig. 4.13 needs to be modified. First, we cannot choose a unique A-production at line (1), so we must try each of several productions in some order. Then, failure at line (7) is not ultimate failure, but suggests only that we need to return to line (1) and try another A-production. Only if there are no more A-productions to try do we declare that an input error has been found. In order to try another A-production, we need to be able to reset the input pointer to where it was when we first reached line (1). Thus, a local variable is needed to store this input pointer for future use.

**Example 4.29:** Consider the grammar

$$\begin{array}{l}
 S \rightarrow cAd \\
 A \rightarrow ab \mid a
 \end{array}$$

To construct a parse tree top-down for the input string  $w = cad$ , begin with a tree consisting of a single node labeled  $S$ , and the input pointer pointing to  $c$ , the first symbol of  $w$ .  $S$  has only one production, so we use it to expand  $S$  and

obtain the tree of Fig. 4.14(a). The leftmost leaf, labeled  $c$ , matches the first symbol of input  $w$ , so we advance the input pointer to  $a$ , the second symbol of  $w$ , and consider the next leaf, labeled  $A$ .

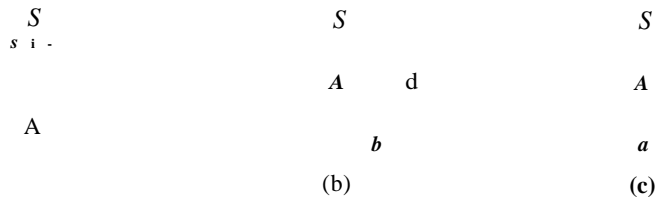

(a) Figure 4.14: Steps in a top-down parse

Now, we expand  $A$  using the first alternative  $A \rightarrow a b$  to obtain the tree of Fig. 4.14(b). We have a match for the second input symbol,  $a$ , so we advance the input pointer to  $d$ , the third input symbol, and compare  $d$  against the next leaf, labeled  $b$ . Since  $b$  does not match  $d$ , we report failure and go back to  $A$  to see whether there is another alternative for  $A$  that has not been tried, but that might produce a match.

In going back to  $A$ , we must reset the input pointer to position 2, the position it had when we first came to  $A$ , which means that the procedure for  $A$  must store the input pointer in a local variable.

The second alternative for  $A$  produces the tree of Fig. 4.14(c). The leaf  $a$  matches the second symbol of  $w$  and the leaf  $d$  matches the third symbol. Since we have produced a parse tree for  $w$ , we halt and announce successful completion of parsing. •

A left-recursive grammar can cause a recursive-descent parser, even one with backtracking, to go into an infinite loop. That is, when we try to expand a nonterminal  $A$ , we may eventually find ourselves again trying to expand  $A$  without having consumed any input.

## 4.4.2 FIRST and FOLLOW

The construction of both top-down and bottom-up parsers is aided by two functions, **FIRST** and **FOLLOW**, associated with a grammar  $G$ . During top-down parsing, **FIRST** and **FOLLOW** allow us to choose which production to apply, based on the next input symbol. During panic-mode error recovery, sets of tokens produced by **FOLLOW** can be used as synchronizing tokens.

Define **FIRST**( $a$ ), where  $a$  is any string of grammar symbols, to be the set of terminals that begin strings derived from  $a$ . If  $a \Rightarrow \epsilon$ , then  $\epsilon$  is also in **FIRST**( $a$ ). For example, in Fig. 4.15,  $A \wedge cy$ , so  $c$  is in **FIRST**( $A$ ).

For a preview of how **FIRST** can be used during predictive parsing, consider two  $A$ -productions  $A \rightarrow a \mid \theta$ , where **FIRST**( $a$ ) and **FIRST**( $\theta$ ) are disjoint sets. We can then choose between these  $A$ -productions by looking at the next input

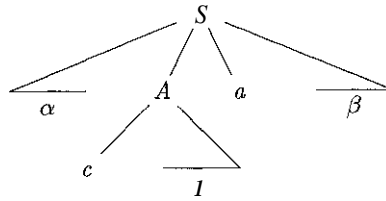
Figure 4.15: Terminal  $c$  is in  $\text{FIRST}(A)$  and  $a$  is in  $\text{FOLLOW}(A)$ 

symbol  $a$ , since  $a$  can be in at most one of  $\text{FIRST}(a)$  and  $\text{FIRST}(\beta)$ , not both. For instance, if  $a$  is in  $\text{FIRST}(\beta)$  choose the production  $A \rightarrow \beta$ . This idea will be explored when LL(1) grammars are defined in Section 4.4.3.

Define  $\text{FOLLOW}(A)$ , for nonterminal  $A$ , to be the set of terminals  $a$  that can appear immediately to the right of  $A$  in some sentential form; that is, the set of terminals  $a$  such that there exists a derivation of the form  $S \Rightarrow \alpha A a \beta$ , for some  $\alpha$  and  $\beta$ , as in Fig. 4.15. Note that there may have been symbols between  $A$  and  $a$ , at some time during the derivation, but if so, they derived  $\epsilon$  and disappeared. In addition, if  $A$  can be the rightmost symbol in some sentential form, then  $\$$  is in  $\text{FOLLOW}(A)$ ; recall that  $\$$  is a special "endmarker" symbol that is assumed not to be a symbol of any grammar.

To compute  $\text{FIRST}(X)$  for all grammar symbols  $X$ , apply the following rules until no more terminals or  $\epsilon$  can be added to any  $\text{FIRST}$  set.

1. If  $X$  is a terminal, then  $\text{FIRST}(X) = \{X\}$ .
2. If  $X$  is a nonterminal and  $X \rightarrow Y_1 Y_2 \dots Y_k$  is a production for some  $k > 1$ , then place  $a$  in  $\text{FIRST}(X)$  if for some  $i$ ,  $a$  is in  $\text{FIRST}(Y_i)$ , and  $\epsilon$  is in all of  $\text{FIRST}(Y_1), \dots, \text{FIRST}(Y_{i-1})$ ; that is,  $Y_1 \dots Y_{i-1} \Rightarrow \epsilon$ . If  $\epsilon$  is in  $\text{FIRST}(Y_j)$  for all  $j = 1, 2, \dots, k$ , then add  $\epsilon$  to  $\text{FIRST}(X)$ . For example, everything in  $\text{FIRST}(Y_1)$  is surely in  $\text{FIRST}(X)$ . If  $Y_1$  does not derive  $\epsilon$ , then we add nothing more to  $\text{FIRST}(X)$ , but if  $Y_1 \Rightarrow \epsilon$ , then we add  $\text{FIRST}(Y_2)$ , and so on.
3. If  $X \rightarrow \epsilon$  is a production, then add  $\epsilon$  to  $\text{FIRST}(X)$ .

Now, we can compute  $\text{FIRST}$  for any string  $X_1 X_2 \dots X_n$  as follows. Add to  $\text{FIRST}(X_1 X_2 \dots X_n)$  all non- $\epsilon$  symbols of  $\text{FIRST}(X_1)$ . Also add the non- $\epsilon$  symbols of  $\text{FIRST}(X_2)$ , if  $\epsilon$  is in  $\text{FIRST}(X_1)$ ; the non- $\epsilon$  symbols of  $\text{FIRST}(X_3)$ , if  $\epsilon$  is in  $\text{FIRST}(X_1)$  and  $\text{FIRST}(X_2)$ ; and so on. Finally, add  $\epsilon$  to  $\text{FIRST}(X_1 X_2 \dots X_n)$  if, for all  $i$ ,  $\epsilon$  is in  $\text{FIRST}(X_i)$ .

To compute  $\text{FOLLOW}(A)$  for all nonterminals  $A$ , apply the following rules until nothing can be added to any  $\text{FOLLOW}$  set.

1. Place  $\$$  in  $\text{FOLLOW}(S)$ , where  $S$  is the start symbol, and  $\$$  is the input right endmarker.

2. If there is a production  $A \rightarrow aB/3$ , then everything in  $\text{FIRST}(/3)$  except  $e$  is in  $\text{FOLLOW}(5)$ .
3. If there is a production  $A \rightarrow aB$ , or a production  $A \rightarrow aB/3$ , where  $\text{FIRST}(\wedge)$  contains  $e$ , then everything in  $\text{FOLLOW}(A)$  is in  $\text{FOLLOW}(B)$ .

Example 4.30: Consider again the non-left-recursive grammar (4.28). Then:

1.  $\text{FIRST}(F) = \text{FIRST}(T) = \text{FIRST}(E) = \{(\text{id})\}$ . To see why, note that the two productions for  $F$  have bodies that start with these two terminal symbols,  $\text{id}$  and the left parenthesis.  $T$  has only one production, and its body starts with  $F$ . Since  $F$  does not derive  $e$ ,  $\text{FIRST}(T)$  must be the same as  $\text{FIRST}(F)$ . The same argument covers  $\text{FIRST}(E)$ .
2.  $\text{FIRST}(E') = \{+, e\}$ . The reason is that one of the two productions for  $E'$  has a body that begins with terminal  $+$ , and the other's body is  $e$ . Whenever a nonterminal derives  $e$ , we place  $e$  in  $\text{FIRST}$  for that nonterminal.
3.  $\text{FIRST}(T') = \{*, e\}$ . The reasoning is analogous to that for  $\text{FIRST}(E')$ .
4.  $\text{FOLLOW}(E) = \text{FOLLOW}(E') = \{), \$\}$ . Since  $E$  is the start symbol,  $\text{FOLLOW}(E)$  must contain  $\$$ . The production body  $( E )$  explains why the right parenthesis is in  $\text{FOLLOW}(E)$ . For  $E'$ , note that this nonterminal appears only at the ends of bodies of  $E$ -productions. Thus,  $\text{FOLLOW}(E')$  must be the same as  $\text{FOLLOW}(E)$ .
5.  $\text{FOLLOW}(T) = \text{FOLLOW}(T') = \{+, ), \$\}$ . Notice that  $T$  appears in bodies only followed by  $E'$ . Thus, everything except  $e$  that is in  $\text{FIRST}(E')$  must be in  $\text{FOLLOW}(T)$ ; that explains the symbol  $+$ . However, since  $\text{FIRST}(E')$  contains  $e$  (i.e.,  $E' \xrightarrow{4} e$ ), and  $E'$  is the entire string following  $T$  in the bodies of the  $E$ -productions, everything in  $\text{FOLLOW}(E)$  must also be in  $\text{FOLLOW}(T)$ . That explains the symbols  $\$$  and the right parenthesis. As for  $T'$ , since it appears only at the ends of the  $T$ -productions, it must be that  $\text{FOLLOW}(T') = \text{FOLLOW}(T)$ .
6.  $\text{FOLLOW}(F) = \{+, *, ), \$\}$ . The reasoning is analogous to that for  $T$  in point (5).

•

### 4.4.3 LL(1) Grammars

Predictive parsers, that is, recursive-descent parsers needing no backtracking, can be constructed for a class of grammars called LL(1). The first "L" in LL(1) stands for scanning the input from left to right, the second "L" for producing a leftmost derivation, and the "1" for using one input symbol of lookahead at each step to make parsing action decisions.

### Transition Diagrams for Predictive Parsers

Transition diagrams are useful for visualizing predictive parsers. For example, the transition diagrams for nonterminals  $E$  and  $E'$  of grammar (4.28) appear in Fig. 4.16(a). To construct the transition diagram from a grammar, first eliminate left recursion and then left factor the grammar. Then, for each nonterminal  $A$ ,

1. Create an initial and final (return) state.
2. For each production  $A \rightarrow X_1 X_2 \dots X_k$ , create a path from the initial to the final state, with edges labeled  $X_1, X_2, \dots, X_k$ . If  $A \rightarrow \epsilon$ , the path is an edge labeled  $\epsilon$ .

Transition diagrams for predictive parsers differ from those for lexical analyzers. Parsers have one diagram for each nonterminal. The labels of edges can be tokens or nonterminals. A transition on a token (terminal) means that we take that transition if that token is the next input symbol. A transition on a nonterminal  $A$  is a call of the procedure for  $A$ .

With an LL(1) grammar, the ambiguity of whether or not to take an  $\epsilon$ -edge can be resolved by making  $\epsilon$ -transitions the default choice.

Transition diagrams can be simplified, provided the sequence of grammar symbols along paths is preserved. We may also substitute the diagram for a nonterminal  $A$  in place of an edge labeled  $A$ . The diagrams in Fig. 4.16(a) and (b) are equivalent: if we trace paths from  $E$  to an accepting state and substitute for  $E'$ , then, in both sets of diagrams, the grammar symbols along the paths make up strings of the form  $T + T \rightarrow T$ . The diagram in (b) can be obtained from (a) by transformations akin to those in Section 2.5.4, where we used tail-recursion removal and substitution of procedure bodies to optimize the procedure for a nonterminal.

The class of LL(1) grammars is rich enough to cover most programming constructs, although care is needed in writing a suitable grammar for the source language. For example, no left-recursive or ambiguous grammar can be LL(1).

A grammar  $G$  is LL(1) if and only if whenever  $A \rightarrow a \mid f\beta$  were two distinct productions of  $G$ , the following conditions hold:

1. For no terminal  $a$  do both  $a$  and  $f\beta$  derive strings beginning with  $a$ .
2. At most one of  $a$  and  $f\beta$  can derive the empty string.
3. If  $f\beta \neq \epsilon$ , then  $a$  does not derive any string beginning with a terminal in FOLLOW( $A$ ). Likewise, if  $a \neq \epsilon$ , then  $f\beta$  does not derive any string beginning with a terminal in FOLLOW( $A$ ).

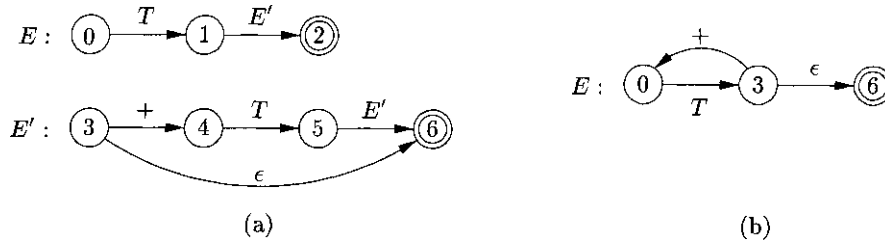
Figure 4.16: Transition diagrams for nonterminals  $E$  and  $E'$  of grammar 4.28

The first two conditions are equivalent to the statement that  $\text{FIRST}(a)$  and  $\text{FIRST}(?)$  are disjoint sets. The third condition is equivalent to stating that if  $e$  is in  $\text{FIRST}(?)$ , then  $\text{FIRST}(a)$  and  $\text{FOLLOW}(A)$  are disjoint sets, and likewise if  $e$  is in  $\text{FIRST}(a)$ .

Predictive parsers can be constructed for LL(1) grammars since the proper production to apply for a nonterminal can be selected by looking only at the current input symbol. Flow-of-control constructs, with their distinguishing keywords, generally satisfy the LL(1) constraints. For instance, if we have the productions

$$\begin{aligned} \text{stmt} &\rightarrow \mathbf{if} ( \text{expr} ) \text{stmt} \mathbf{else} \text{stmt} \\ &| \mathbf{while} ( \text{expr} ) \text{stmt} \\ &| \{ \text{stmtList} \} \end{aligned}$$

then the keywords **if**, **while**, and the symbol  $\{$  tell us which alternative is the only one that could possibly succeed if we are to find a statement.

The next algorithm collects the information from  $\text{FIRST}$  and  $\text{FOLLOW}$  sets into a predictive parsing table  $M[A, a]$ , a two-dimensional array, where  $A$  is a nonterminal, and  $a$  is a terminal or the symbol  $\$,$  the input endmarker. The algorithm is based on the following idea: the production  $A \rightarrow a$  is chosen if the next input symbol  $a$  is in  $\text{FIRST}(A)$ . The only complication occurs when  $a = \epsilon$  or, more generally,  $a \in \text{FIRST}(A)$ . In this case, we should again choose  $A \rightarrow a$ , if the current input symbol is in  $\text{FOLLOW}(A)$ , or if the  $\$$  on the input has been reached and  $\$$  is in  $\text{FOLLOW}(A)$ .

**Algorithm 4.31:** Construction of a predictive parsing table.

**INPUT:** Grammar  $G$ .

**OUTPUT:** Parsing table  $M$ .

**METHOD:** For each production  $A \rightarrow a$  of the grammar, do the following:

1. For each terminal  $a$  in  $\text{FIRST}(A)$ , add  $A \rightarrow a$  to  $M[A, a]$ .
2. If  $\epsilon$  is in  $\text{FIRST}(A)$ , then for each terminal  $b$  in  $\text{FOLLOW}(A)$ , add  $A \rightarrow \epsilon$  to  $M[A, b]$ . If  $\epsilon$  is in  $\text{FIRST}(A)$  and  $\$$  is in  $\text{FOLLOW}(A)$ , add  $A \rightarrow \epsilon$  to  $M[A, \$]$  as well.

If, after performing the above, there is no production at all in  $M[A, a]$ , then set  $M[A, a]$  to error (which we normally represent by an empty entry in the table). •

Example 4.32: For the expression grammar (4.28), Algorithm 4.31 produces the parsing table in Fig. 4.17. Blanks are error entries; nonblanks indicate a production with which to expand a nonterminal.

NON - TERMINAL	INPUT SYMBOL					
	id	+	*	(	)	\$
$E$	$E \rightarrow TE'$			$E \rightarrow TE'$		
$E'$		$E' \rightarrow +TE'$				$E' \rightarrow e$
$T$	$T \rightarrow FT'$			$T \rightarrow FT'$		
$r$		$T' \rightarrow e$	$T' \rightarrow *FT'$		$T' \rightarrow e$	$T' \rightarrow e$
$F$	$F \rightarrow id$			$F \rightarrow (F)$		

Figure 4.17: Parsing table  $M$  for Example 4.32

Consider production  $E \rightarrow TE'$ . Since

$$\text{FIRST}(TE') = \text{FIRST}(T) = \{(\text{id})\}$$

this production is added to  $M[E, (]$  and  $M[E, \text{id}]$ . Production  $E' \rightarrow +TE'$  is added to  $M[E', +]$  since  $\text{FIRST}(+TE') = \{+\}$ . Since  $\text{FOLLOW}^{\wedge}(E') = \{(), \$\}$ , production  $E' \rightarrow e$  is added to  $M[E', )]$  and  $M[E', \$]$ . •

Algorithm 4.31 can be applied to any grammar  $G$  to produce a parsing table  $M$ . For every LL(1) grammar, each parsing-table entry uniquely identifies a production or signals an error. For some grammars, however,  $M$  may have some entries that are multiply defined. For example, if  $G$  is left-recursive or ambiguous, then  $M$  will have at least one multiply defined entry. Although left-recursion elimination and left factoring are easy to do, there are some grammars for which no amount of alteration will produce an LL(1) grammar.

The language in the following example has no LL(1) grammar at all.

Example 4.33: The following grammar, which abstracts the dangling-else problem, is repeated here from Example 4.22:

$$\begin{aligned} S & \rightarrow iEtSS' \mid a \\ S' & \rightarrow eS \mid e \\ E & \rightarrow b \end{aligned}$$

The parsing table for this grammar appears in Fig. 4.18. The entry for  $M[S', e]$  contains both  $S' \rightarrow eS$  and  $S' \rightarrow e$ .

The grammar is ambiguous and the ambiguity is manifested by a choice in what production to use when an  $e$  (else) is seen. We can resolve this ambiguity



NON - TERMINAL	INPUT SYMBOL					
	$a$	$b$	$e$	$i$	$t$	$\$$
$S$	$S \rightarrow a$			$S \rightarrow iEtSS'$		
$S'$			$S' \rightarrow eS$			
$E$		$E \rightarrow b$				

Figure 4.18: Parsing table  $M$  for Example 4.33

by choosing  $S' \rightarrow eS$ . This choice corresponds to associating an **else** with the closest previous **then**. Note that the choice  $S' \rightarrow e$  would prevent  $e$  from ever being put on the stack or removed from the input, and is surely wrong. •

#### 4.4.4 Nonrecursive Predictive Parsing

A nonrecursive predictive parser can be built by maintaining a stack explicitly, rather than implicitly via recursive calls. The parser mimics a leftmost derivation. If  $w$  is the input that has been matched so far, then the stack holds a sequence of grammar symbols  $a$  such that

$$S \quad wd$$

The table-driven parser in Fig. 4.19 has an input buffer, a stack containing a sequence of grammar symbols, a parsing table constructed by Algorithm 4.31, and an output stream. The input buffer contains the string to be parsed, followed by the endmarker  $\$$ . We reuse the symbol  $\$$  to mark the bottom of the stack, which initially contains the start symbol of the grammar on top of  $\$$ .

The parser is controlled by a program that considers  $X$ , the symbol on top of the stack, and  $a$ , the current input symbol. If  $X$  is a nonterminal, the parser chooses an  $X$ -production by consulting entry  $M[X, a]$  of the parsing table  $M$ . (Additional code could be executed here, for example, code to construct a node in a parse tree.) Otherwise, it checks for a match between the terminal  $X$  and current input symbol  $a$ .

The behavior of the parser can be described in terms of its *configurations*, which give the stack contents and the remaining input. The next algorithm describes how configurations are manipulated.

**Algorithm 4.34:** Table-driven predictive parsing.

**INPUT:** A string  $w$  and a parsing table  $M$  for grammar  $G$ .

**OUTPUT:** If  $w$  is in  $L(G)$ , a leftmost derivation of  $w$ ; otherwise, an error indication.



MATCHED	STACK	INPUT	ACTION
	<i>E</i> %	<b>id + id * id</b> \$	
	<i>TE</i> '%	<b>id + id * id</b> \$	output <i>E</i> -> <i>TE</i> '
	<i>FTE</i> '%	<b>id + id * id</b> \$	output <i>T</i> -+ <i>FT</i> '
	<b>id</b> <i>TE</i> '%	<b>id + id * id</b> \$	output <i>F</i> -> <b>id</b>
<b>id</b>	<i>TE</i> '%	<b>+ id * id</b> \$	match <b>id</b>
<b>id</b>	<i>E</i> '%	<b>+ id * id</b> \$	output <i>T</i> " -> e
<b>id</b>	<b>+</b> <i>TE</i> '%	<b>+ id * id</b> \$	output <i>E</i> ' -+ <b>+</b> <i>TE</i> '
<b>id</b> <b>+</b>	<i>TE</i> '%	<b>id * id</b> \$	match <b>+</b>
<b>id</b> <b>+</b>	<i>FTE</i> '%	<b>id * id</b> \$	output <i>T</i> <i>FT</i> '
<b>id</b> <b>+</b>	<b>id</b> <i>TE</i> '%	<b>id * id</b> \$	output <i>F</i> -> <b>id</b>
<b>id</b> <b>+</b> <b>id</b>	<i>TE</i> '%	<b>*id</b> \$	match <b>id</b>
<b>id</b> <b>+</b> <b>id</b>	<b>*</b> <i>FTE</i> '%	<b>*id</b> \$	output <i>T</i> " -> <b>*</b> <i>FT</i> '
<b>id</b> <b>+</b> <b>id</b> <b>*</b>	<i>FTE</i> '%	<b>id</b> \$	match <b>*</b>
<b>id</b> <b>+</b> <b>id</b> <b>*</b>	<b>id</b> <i>TE</i> '%	<b>id</b> \$	output <i>F</i> -> <b>id</b>
<b>id</b> <b>+</b> <b>id</b> <b>*</b> <b>id</b>	<i>TE</i> '%	<b>\$</b>	match <b>id</b>
<b>id</b> <b>+</b> <b>id</b> <b>*</b> <b>id</b>	<i>E</i> '%	<b>\$</b>	output <i>T</i> ' -+ e
<b>id</b> <b>+</b> <b>id</b> <b>*</b> <b>id</b>	%	<b>\$</b>	output <i>E</i> ' -+ e

Figure 4.21: Moves made by a predictive parser on input **id + id \* id**

Note that the sentential forms in this derivation correspond to the input that has already been matched (in column **MATCHED**) followed by the stack contents. The matched input is shown only to highlight the correspondence. For the same reason, the top of the stack is to the left; when we consider bottom-up parsing, it will be more natural to show the top of the stack to the right. The input pointer points to the leftmost symbol of the string in the **INPUT** column. •

#### 4.4.5 Error Recovery in Predictive Parsing

This discussion of error recovery refers to the stack of a table-driven predictive parser, since it makes explicit the terminals and nonterminals that the parser hopes to match with the remainder of the input; the techniques can also be used with recursive-descent parsing.

An error is detected during predictive parsing when the terminal on top of the stack does not match the next input symbol or when nonterminal *A* is on top of the stack, *a* is the next input symbol, and  $M[A, a]$  is **error** (i.e., the parsing-table entry is empty).

##### Panic Mode

Panic-mode error recovery is based on the idea of skipping symbols on the the input until a token in a selected set of synchronizing tokens appears. Its

effectiveness depends on the choice of synchronizing set. The sets should be chosen so that the parser recovers quickly from errors that are likely to occur in practice. Some heuristics are as follows:

1. As a starting point, place all symbols in FOLLOW(A) into the synchronizing set for nonterminal A. If we skip tokens until an element of FOLLOW(A) is seen and pop A from the stack, it is likely that parsing can continue.
2. It is not enough to use FOLLOW(A) as the synchronizing set for A. For example, if semicolons terminate statements, as in C, then keywords that begin statements may not appear in the FOLLOW set of the nonterminal representing expressions. A missing semicolon after an assignment may therefore result in the keyword beginning the next statement being skipped. Often, there is a hierarchical structure on constructs in a language; for example, expressions appear within statements, which appear within blocks, and so on. We can add to the synchronizing set of a lower-level construct the symbols that begin higher-level constructs. For example, we might add keywords that begin statements to the synchronizing sets for the nonterminals generating expressions.
3. If we add symbols in FIRST(A) to the synchronizing set for nonterminal A, then it may be possible to resume parsing according to A if a symbol in FIRST(A) appears in the input.
4. If a nonterminal can generate the empty string, then the production deriving  $\epsilon$  can be used as a default. Doing so may postpone some error detection, but cannot cause an error to be missed. This approach reduces the number of nonterminals that have to be considered during error recovery.
5. If a terminal on top of the stack cannot be matched, a simple idea is to pop the terminal, issue a message saying that the terminal was inserted, and continue parsing. In effect, this approach takes the synchronizing set of a token to consist of all other tokens.

Example 4.36: Using FIRST and FOLLOW symbols as synchronizing tokens works reasonably well when expressions are parsed according to the usual grammar (4.28). The parsing table for this grammar in Fig. 4.17 is repeated in Fig. 4.22, with "synch" indicating synchronizing tokens obtained from the FOLLOW set of the nonterminal in question. The FOLLOW sets for the nonterminals are obtained from Example 4.30.

The table in Fig. 4.22 is to be used as follows. If the parser looks up entry  $M[A,a]$  and finds that it is blank, then the input symbol  $a$  is skipped. If the entry is "synch," then the nonterminal on top of the stack is popped in an attempt to resume parsing. If a token on top of the stack does not match the input symbol, then we pop the token from the stack, as mentioned above.

NON - TERMINAL	INPUT SYMBOL					
	id	+	*	(	)	\$
$E$	$E \rightarrow TE'$			$E \rightarrow TE'$	synch	synch
$E'$		$E \rightarrow +TE'$			$E \rightarrow e$	$E \rightarrow ye$
$T$	$T \rightarrow FT'$	synch		$T \rightarrow FT'$	synch	synch
$T'$		$T' \rightarrow e$	$T' \rightarrow *FT'$		$T' \rightarrow *e$	$T' \rightarrow ve$
$F$	$F \rightarrow id$	synch	synch	$F \rightarrow (F)$	synch	synch

Figure 4.22: Synchronizing tokens added to the parsing table of Fig. 4.17

On the erroneous input)  $id * + id$ , the parser and error recovery mechanism of Fig. 4.22 behave as in Fig. 4.23. •

STACK	INPUT	REMARK
$E\%$	) $id * + id \$$	error, skip )
$E\%$	$id * + id \$$	$id$ is in $FIRST(E)$
$TE'\%$	$id * + id \$$	
$FTE'\%$	$id * + id \$$	
$id TE'\%$	$id * + id \$$	
$TE'\%$	$* + id \$$	
$* FTE'\%$	$* + id \$$	
$FTE'\%$	$+ id \$$	error, $M[F, +] = \text{synch}$
$TE'\%$	$+ id \$$	$F$ has been popped
$E'\%$	$+ id \$$	
$+ TE'\%$	$+ id \$$	
$TE'\%$	$id \$$	
$FTE'\%$	$id \$$	
$id TE'\%$	$id \$$	
$TE'\%$	$\$$	
$E'\%$	$\$$	
$\$$	$\$$	

Figure 4.23: Parsing and error recovery moves made by a predictive parser

The above discussion of panic-mode recovery does not address the important issue of error messages. The compiler designer must supply informative error messages that not only describe the error, they must draw attention to where the error was discovered.

**Phrase-level Recovery**

Phrase-level error recovery is implemented by filling in the blank entries in the predictive parsing table with pointers to error routines. These routines may change, insert, or delete symbols on the input and issue appropriate error messages. They may also pop from the stack. Alteration of stack symbols or the pushing of new symbols onto the stack is questionable for several reasons. First, the steps carried out by the parser might then not correspond to the derivation of any word in the language at all. Second, we must ensure that there is no possibility of an infinite loop. Checking that any recovery action eventually results in an input symbol being consumed (or the stack being shortened if the end of the input has been reached) is a good way to protect against such loops.

**4.4.6 Exercises for Section 4.4**

**Exercise 4.4.1:** For each of the following grammars, devise predictive parsers and show the parsing tables. You may left-factor and/of eliminate left-recursion from your grammars first.

- a) The grammar of Exercise 4.2.2(a).
- b) The grammar of Exercise 4.2.2(b).
- c) The grammar of Exercise 4.2.2(c).
- d) The grammar of Exercise 4.2.2(d).
- e) The grammar of Exercise 4.2.2(e).
- f) The grammar of Exercise 4.2.2(g).

**!! Exercise 4.4.2:** Is it possible, by modifying the grammar in any way, to construct a predictive parser for the language of Exercise 4.2.1 (postfix expressions with operand *a*)?

**Exercise 4.4.3:** Compute FIRST and FOLLOW for the grammar of Exercise 4.2.1.

**Exercise 4.4.4:** Compute FIRST and FOLLOW for each of the grammars of Exercise 4.2.2.

**Exercise 4.4.5:** The grammar  $S \rightarrow a S a \mid a a$  generates all even-length strings of *a*'s. We can devise a recursive-descent parser with backtrack for this grammar. If we choose to expand by production  $S \rightarrow \bullet a a$  first, then we shall only recognize the string *aa*. Thus, any reasonable recursive-descent parser will try  $S \rightarrow a S a$  first.

- a) Show that this recursive-descent parser recognizes inputs *aa*, *aaaa*, and *aaaaaaaa*, but not *aaaaaa*.

!! b) What language does this recursive-descent parser recognize?

The following exercises are useful steps in the construction of a "Chomsky Normal Form" grammar from arbitrary grammars, as defined in Exercise 4.4.8.

**! Exercise 4.4.6:** A grammar is *e-free* if no production body is  $\epsilon$  (called an *e-production*).

- a) Give an algorithm to convert any grammar into an  $\epsilon$ -free grammar that generates the same language (with the possible exception of the empty string — no  $\epsilon$ -free grammar can generate  $\epsilon$ ).
- b) Apply your algorithm to the grammar  $S \rightarrow aSbS \mid bSaS \mid \epsilon$ . *Hint:* First find all the nonterminals that are *nullable*, meaning that they generate  $\epsilon$ , perhaps by a long derivation.

**! Exercise 4.4.7:** A *single production* is a production whose body is a single nonterminal, i.e., a production of the form  $A \rightarrow A$ .

- a) Give an algorithm to convert any grammar into an  $\epsilon$ -free grammar, with no single productions, that generates the same language (with the possible exception of the empty string) *Hint:* First eliminate  $\epsilon$ -productions, and then find for which pairs of nonterminals  $A$  and  $B$  does  $A \Rightarrow^* B$  by a sequence of single productions.
- b) Apply your algorithm to the grammar (4.1) in Section 4.1.2.
- c) Show that, as a consequence of part (a), we can convert a grammar into an equivalent grammar that has no *cycles* (derivations of one or more steps in which  $A \Rightarrow^* A$  for some nonterminal  $A$ ).

**!! Exercise 4.4.8:** A grammar is said to be in *Chomsky Normal Form* (CNF) if every production is either of the form  $A \rightarrow BC$  or of the form  $A \rightarrow a$ , where  $A$ ,  $B$ , and  $C$  are nonterminals, and  $a$  is a terminal. Show how to convert any grammar into a CNF grammar for the same language (with the possible exception of the empty string — no CNF grammar can generate  $\epsilon$ ).

**! Exercise 4.4.9:** Every language that has a context-free grammar can be recognized in at most  $O(n^3)$  time for strings of length  $n$ . A simple way to do so, called the *Cocke-Younger-Kasami* (or CYK) algorithm is based on dynamic programming. That is, given a string  $a_1 a_2 \dots a_n$ , we construct an  $n$ -by- $n$  table  $T$  such that  $T_{ij}$  is the set of nonterminals that generate the substring  $a_i a_{i+1} \dots a_j$ . If the underlying grammar is in CNF (see Exercise 4.4.8), then one table entry can be filled in in  $O(n)$  time, provided we fill the entries in the proper order: lowest value *off-i* first. Write an algorithm that correctly fills in the entries of the table, and show that your algorithm takes  $O(n^3)$  time. Having filled in the table, how do you determine whether  $a_1 a_2 \dots a_n$  is in the language?

! **Exercise 4.4.10:** Show how, having filled in the table as in Exercise 4.4.9, we can in  $O(n)$  time recover a parse tree for  $a_1a_2\dots a_n$ . *Hint:* modify the table so it records, for each nonterminal  $A$  in each table entry  $T_{ij}$ , some pair of nonterminals in other table entries that justified putting  $A$  in  $T_{ij}$ .

! **Exercise 4.4.11:** Modify your algorithm of Exercise 4.4.9 so that it will find, for any string, the smallest number of insert, delete, and mutate errors (each error a single character) needed to turn the string into a string in the language of the underlying grammar.

$$\begin{array}{lcl}
 \textit{stmt} & \rightarrow & \text{if } e \text{ then } \textit{stmt} \textit{ stmtTail} \\
 & | & \text{while } e \text{ do } \textit{stmt} \\
 & | & \text{begin } \textit{list} \text{ end} \\
 & | & \text{\texttt{\$}} \\
 \textit{stmtTail} & \rightarrow & \text{else } \textit{stmt} \\
 & | & \text{\texttt{e}} \\
 \textit{list} & \rightarrow & \textit{stmt} \textit{ UstTail} \\
 \textit{list} \textit{ Tail} & \rightarrow & ; \textit{list} \\
 & -\text{\texttt{\$}} & e
 \end{array}$$

Figure 4.24: A grammar for certain kinds of statements

! **Exercise 4.4.12:** In Fig. 4.24 is a grammar for certain statements. You may take  $e$  and  $s$  to be terminals standing for conditional expressions and "other statements," respectively. If we resolve the conflict regarding expansion of the optional "else" (nonterminal  $\textit{stmtTail}$ ) by preferring to consume an **else** from the input whenever we see one, we can build a predictive parser for this grammar. Using the idea of synchronizing symbols described in Section 4.4.5:

- Build an error-correcting predictive parsing table for the grammar.
- Show the behavior of your parser on the following inputs:

(i) **if**  $e$  **then**  $s$  ; **if**  $e$  **then**  $s$  **end**  
(M) **while**  $e$  **do** **begin**  $s$  ; **if**  $e$  **then**  $s$  ; **end**

## 4.5 Bottom-Up Parsing

A bottom-up parse corresponds to the construction of a parse tree for an input string beginning at the leaves (the bottom) and working up towards the root (the top). It is convenient to describe parsing as the process of building parse trees, although a front end may in fact carry out a translation directly without building an explicit tree. The sequence of tree snapshots in Fig. 4.25 illustrates



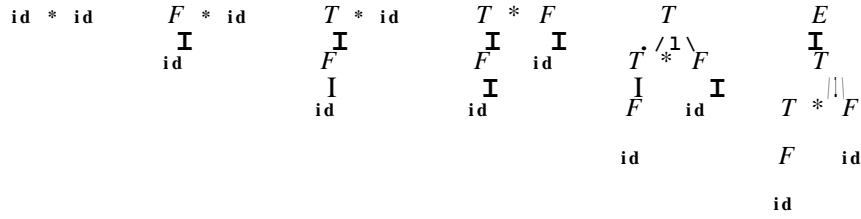

Figure 4.25: A bottom-up parse for **id \* id**

a bottom-up parse of the token stream **id \* id**, with respect to the expression grammar (4.1).

This section introduces a general style of bottom-up parsing known as shift-reduce parsing. The largest class of grammars for which shift-reduce parsers can be built, the LR grammars, will be discussed in Sections 4.6 and 4.7. Although it is too much work to build an LR parser by hand, tools called automatic parser generators make it easy to construct efficient LR parsers from suitable grammars. The concepts in this section are helpful for writing suitable grammars to make effective use of an LR parser generator. Algorithms for implementing parser generators appear in Section 4.7.

### 4.5.1 Reductions

We can think of bottom-up parsing as the process of "reducing" a string  $w$  to the start symbol of the grammar. At each *reduction* step, a specific substring matching the body of a production is replaced by the nonterminal at the head of that production.

The key decisions during bottom-up parsing are about when to reduce and about what production to apply, as the parse proceeds.

Example 4.37: The snapshots in Fig. 4.25 illustrate a sequence of reductions; the grammar is the expression grammar (4.1). The reductions will be discussed in terms of the sequence of strings

$$\mathbf{id * id}, \mathbf{F * id}, \mathbf{T * id}, \mathbf{T * F}, \mathbf{T}, \mathbf{E}$$

The strings in this sequence are formed from the roots of all the subtrees in the snapshots. The sequence starts with the input string **id\*id**. The first reduction produces **F\*id** by reducing the leftmost **id** to **F**, Using the production  $F \rightarrow id$ . The second reduction produces **T \* id** by reducing **F** to **T**.

Now, we have a choice between reducing the string **T**, which is the body of  $E \rightarrow T$ , and the string consisting of the second **id**, which is the body of  $F \rightarrow id$ . Rather than reduce **T** to **E**, the second **id** is reduced to **T**, resulting in the string **T \* F**. This string then reduces to **T**. The parse completes with the reduction of **T** to the start symbol **E**. •

By definition, a reduction is the reverse of a step in a derivation (recall that in a derivation, a nonterminal in a sentential form is replaced by the body of one of its productions). The goal of bottom-up parsing is therefore to construct a derivation in reverse. The following derivation corresponds to the parse in Fig. 4.25:

$$E \Rightarrow T \Rightarrow T * F \quad T * \mathbf{id} \Rightarrow F * \mathbf{id} \quad \mathbf{id} * \mathbf{id}$$

This derivation is in fact a rightmost derivation.

### 4.5.2 Handle Pruning

Bottom-up parsing during a left-to-right scan of the input constructs a rightmost derivation in reverse. Informally, a "handle" is a substring that matches the body of a production, and whose reduction represents one step along the reverse of a rightmost derivation.

For example, adding subscripts to the tokens **id** for clarity, the handles during the parse of **idi \* id**, according to the expression grammar (4.1) are as in Fig. 4.26. Although *T* is the body of the production  $E \rightarrow T$ , the symbol *T* is not a handle in the sentential form  $T * \mathbf{id}_1 \quad \mathbf{d} \quad \mathbf{2}$ . If *T* were indeed replaced by *E*, we would get the string  $E * \mathbf{id}_1$ , which cannot be derived from the start symbol *E*. Thus, the leftmost substring that matches the body of some production need not be a handle.

RIGHT SENTENTIAL FORM	HANDLE	REDUCING PRODUCTION
<b>idi * id<sub>1</sub></b>	<b>idi</b>	$F \rightarrow \mathbf{id}$
<b>F * id<sub>1</sub></b>	<b>F</b>	$T \rightarrow F$
<b>T * id<sub>1</sub></b>	<b>id<sub>1</sub></b>	$F \rightarrow \mathbf{id}$
<b>T * F</b>	<b>T * F</b>	$E \rightarrow T * F$

Figure 4.26: Handles during a parse of **idi \* id**.

Formally, if  $S \xRightarrow{rm} aAw \xRightarrow{rm} a\beta w$ , as in Fig. 4.27, then production  $A \rightarrow j\beta$  in the position following *a* is a *handle* of  $a\beta w$ . Alternatively, a handle of a right-sentential form  $\gamma$  is a production  $A \rightarrow \beta$  and a position of  $\gamma$  where the string  $\beta$  may be found, such that replacing  $\beta$  at that position by *A* produces the previous right-sentential form in a rightmost derivation of  $\gamma$ .

Notice that the string *w* to the right of the handle must contain only terminal symbols. For convenience, we refer to the body  $j\beta$  rather than  $A \rightarrow j\beta$  as a handle. Note we say "a handle" rather than "the handle," because the grammar could be ambiguous, with more than one rightmost derivation of  $a\beta w$ . If a grammar is unambiguous, then every right-sentential form of the grammar has exactly one handle.

A rightmost derivation in reverse can be obtained by "handle pruning." That is, we start with a string of terminals *w* to be parsed. If **ID** is a sentence

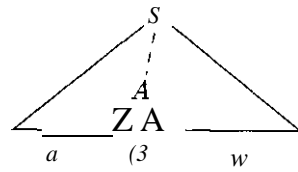
Figure 4.27: A handle  $A \rightarrow j\beta$  in the parse tree for  $a(3w$ 

of the grammar at hand, then let  $w = j_n$ , where  $\gamma_n$  is the  $n$ th right-sentential form of some as yet unknown rightmost derivation

$$S = \gamma_0 \Rightarrow \underset{rm}{\gamma_1} \quad \underset{rm}{\gamma_2} \quad \cdots \quad \underset{rm}{\gamma_{n-1}} \quad \underset{rm}{\gamma_n} = w$$

To reconstruct this derivation in reverse order, we locate the handle  $j\beta_n$  in  $\gamma_n$  and replace  $(\beta_n$  by the head of the relevant production  $A_n \rightarrow j\beta_n$  to obtain the previous right-sentential form  $\gamma_{n-1}$ . Note that we do not yet know how handles are to be found, but we shall see methods of doing so shortly.

We then repeat this process. That is, we locate the handle  $j\beta_{n-1}$  in  $\gamma_{n-1}$  and reduce this handle to obtain the right-sentential form  $\gamma_{n-2}$ . If by continuing this process we produce a right-sentential form consisting only of the start symbol  $S$ , then we halt and announce successful completion of parsing. The reverse of the sequence of productions used in the reductions is a rightmost derivation for the input string.

### 4.5.3 Shift-Reduce Parsing

Shift-reduce parsing is a form of bottom-up parsing in which a stack holds grammar symbols and an input buffer holds the rest of the string to be parsed. As we shall see, the handle always appears at the top of the stack just before it is identified as the handle.

We use  $\$$  to mark the bottom of the stack and also the right end of the input. Conventionally, when discussing bottom-up parsing, we show the top of the stack on the right, rather than on the left as we did for top-down parsing. Initially, the stack is empty, and the string  $w$  is on the input, as follows:

STACK	INPUT
\$	

During a left-to-right scan of the input string, the parser shifts zero or more input symbols onto the stack, until it is ready to reduce a string  $\beta$  of grammar symbols on top of the stack. It then reduces  $\beta$  to the head of the appropriate production. The parser repeats this cycle until it has detected an error or until the stack contains the start symbol and the input is empty:

STACK	INPUT
\$5	\$

Upon entering this configuration, the parser halts and announces successful completion of parsing. Figure 4.28 steps through the actions a shift-reduce parser might take in parsing the input string `idi *icl2` according to the expression grammar (4.1).

STACK	INPUT	ACTION
\$	<b>idi * id</b> , \$	shift
<b>\$idi</b>	* <b>id</b> , \$	reduce by $F \rightarrow id$
\$F	* <b>id</b> , \$	reduce by $T \rightarrow \bullet F$
\$T	* <b>id</b> , \$	shift
\$T*	<b>id</b> , \$	shift
\$T* <b>id</b> ,	\$	reduce by $F \rightarrow \bullet id$
\$T*F	\$	reduce by $T \rightarrow \bullet T * F$
\$T	\$	reduce by $E \rightarrow T$
%E	\$	accept

Figure 4.28: Configurations of a shift-reduce parser on input `idi*id`.

While the primary operations are shift and reduce, there are actually four possible actions a shift-reduce parser can make: (1) shift, (2) reduce, (3) accept, and (4) error.

1. *Shift*. Shift the next input symbol onto the top of the stack.
2. *Reduce*. The right end of the string to be reduced must be at the top of the stack. Locate the left end of the string within the stack and decide with what nonterminal to replace the string.
3. *Accept*. Announce successful completion of parsing.
4. *Error*. Discover a syntax error and call an error recovery routine.

The use of a stack in shift-reduce parsing is justified by an important fact: the handle will always eventually appear on top of the stack, never inside. This fact can be shown by considering the possible forms of two successive steps in any rightmost derivation. Figure 4.29 illustrates the two possible cases. In case (1),  $A$  is replaced by  $(3By)$ , and then the rightmost nonterminal  $B$  in the body  $(3By)$  is replaced by  $\bar{7}$ . In case (2),  $A$  is again expanded first, but this time the body is a string  $y$  of terminals only. The next rightmost nonterminal  $B$  will be somewhere to the left of  $y$ .

In other words:

$$\begin{array}{l}
 (1) \quad S \quad aAz \Rightarrow \underset{rgn}{a} \underset{rm}{f} B \underset{rm}{y} z =^{\wedge} \underset{rm}{a} f i y y z \\
 (2) \quad S \Rightarrow \bullet a B x A z \bullet \Rightarrow \underset{rm}{a} B x y z \quad a y x y z
 \end{array}$$

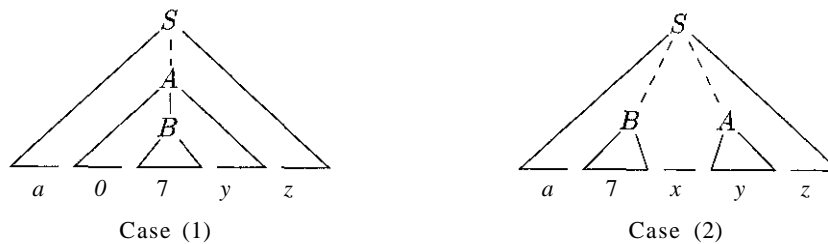

Figure 4.29: Cases for two successive steps of a rightmost derivation

Consider case (1) in reverse, where a shift-reduce parser has just reached the configuration

STACK	INPUT
$\$ \ll / ? 7$	$yz\%$

The parser reduces the handle  $7$  to  $B$  to reach the configuration

$\% a / 3 B$	$yz\%$
--------------	--------

The parser can now shift the string  $y$  onto the stack by a sequence of zero or more shift moves to reach the configuration

$\% a / 3 B y$	$z\$$
----------------	-------

with the handle  $f3By$  on top of the stack, and it gets reduced to  $A$ .

Now consider case (2). In configuration

Scry	$xyz\%$
------	---------

the handle  $7$  is on top of the stack. After reducing the handle  $7$  to  $B$ , the parser can shift the string  $xy$  to get the next handle  $y$  on top of the stack, ready to be reduced to  $A$ :

$\% a B x y$	$z\%$
--------------	-------

In both cases, after making a reduction the parser had to shift zero or more symbols to get the next handle onto the stack. It never had to go into the stack to find the handle.

#### 4.5.4 Conflicts During Shift-Reduce Parsing

There are context-free grammars for which shift-reduce parsing cannot be used. Every shift-reduce parser for such a grammar can reach a configuration in which the parser, knowing the entire stack contents and the next input symbol, cannot decide whether to shift or to reduce (a *shift/reduce conflict*), or cannot decide

which of several reductions to make (a *reduce/reduce conflict*). We now give some examples of syntactic constructs that give rise to such grammars. Technically, these grammars are not in the LR(fc) class of grammars defined in Section 4.7; we refer to them as non-LR grammars. The  $k$  in  $LR(k)$  refers to the number of symbols of lookahead on the input. Grammars used in compiling usually fall in the LR(1) class, with one symbol of lookahead at most.

**Example 4.38:** An ambiguous grammar can never be LR. For example, consider the dangling-else grammar (4.14) of Section 4.3:

$$\begin{array}{l} stmt \quad \rightarrow \quad \text{if } expr \text{ then } stmt \\ \quad \quad \quad | \quad \text{if } expr \text{ then } stmt \text{ else } stmt \\ \quad \quad \quad | \quad \text{other} \end{array}$$

If we have a shift-reduce parser in configuration

STACK	INPUT
• • • if <i>expr</i> then <i>stmt</i>	else • • \$

we cannot tell whether if *expr* then *stmt* is the handle, no matter what appears below it on the stack. Here there is a shift/reduce conflict. Depending on what follows the **else** on the input, it might be correct to reduce if *expr* then *stmt* to *stmt*, or it might be correct to shift **else** and then to look for another *stmt* to complete the alternative if *expr* then *stmt* **else** *stmt*.

Note that shift-reduce parsing can be adapted to parse certain ambiguous grammars, such as the if-then-else grammar above. If we resolve the shift/reduce conflict on **else** in favor of shifting, the parser will behave as we expect, associating each **else** with the previous unmatched **then**. We discuss parsers for such ambiguous grammars in Section 4.8. •

Another common setting for conflicts occurs when we know we have a handle, but the stack contents and the next input symbol are insufficient to determine which production should be used in a reduction. The next example illustrates this situation.

**Example 4.39:** Suppose we have a lexical analyzer that returns the token name id for all names, regardless of their type. Suppose also that our language invokes procedures by giving their names, with parameters surrounded by parentheses, and that arrays are referenced by the same syntax. Since the translation of indices in array references and parameters in procedure calls are different, we want to use different productions to generate lists of actual parameters and indices. Our grammar might therefore have (among others) productions such as those in Fig. 4.30.

A statement beginning with  $p(i,j)$  would appear as the token stream  $id(id, id)$  to the parser. After shifting the first three tokens onto the stack, a shift-reduce parser would be in configuration

(1)	<i>stmt</i>	->	<b>id</b> ( <i>parameterJist</i> )
(2)	<i>stmt</i>		<i>expr</i> := <i>errpr</i>
(3)	<i>parameter-list</i>		<i>parameterJist</i> , <i>parameter</i>
(4)	<i>parameter-list</i>	->	<i>parameter</i>
(5)	<i>parameter</i>		<b>id</b>
(6)	<i>expr</i>		<b>id</b> ( <i>exprJist</i> )
(?)	<i>expr</i>		<b>id</b>
(8)	<i>exprJist</i>		<i>exprJist</i> , <i>expr</i>
(9)	<i>exprJist</i>	->	<i>expr</i>

Figure 4.30: Productions involving procedure calls and array references

STACK	INPUT
••• <b>id</b> ( <b>id</b>	, <b>id</b> ) •••

It is evident that the **id** on top of the stack must be reduced, but by which production? The correct choice is production (5) if *p* is a procedure, but production (7) if *p* is an array. The stack does not tell which; information in the symbol table obtained from the declaration of *p* must be used.

One solution is to change the token **id** in production (1) to **procid** and to use a more sophisticated lexical analyzer that returns the token name **procid** when it recognizes a lexeme that is the name of a procedure. Doing so would require the lexical analyzer to consult the symbol table before returning a token.

If we made this modification, then on processing *p*(*i*,*j*) the parser would be either in the configuration

STACK	INPUT
••• <b>procid</b> ( <b>id</b>	, <b>id</b> ) ••

or in the configuration above. In the former case, we choose reduction by production (5); in the latter case by production (7). Notice how the symbol third from the top of the stack determines the reduction to be made, even though it is not involved in the reduction. Shift-reduce parsing can utilize information far down in the stack to guide the parse. •

### 4.5.5 Exercises for Section 4.5

**Exercise 4.5.1:** For the grammar  $S \rightarrow 0S1 \mid 01$  of Exercise 4.2.2(a), indicate the handle in each of the following right-sentential forms:

a) 000111.

b) 00511.

**Exercise 4.5.2:** Repeat Exercise 4.5.1 for the grammar  $S \rightarrow 5S+ \mid 5S* \mid a$  of Exercise 4.2.1 and the following right-sentential forms:

- a)  $SSS + a^*+$ .
- b)  $SS + a^*a+$ .
- c)  $aaa * a + +$ .

Exercise 4.5.3: Give bottom-up parses for the following input strings and grammars:

- a) The input 000111 according to the grammar of Exercise 4.5.1.
- b) The input  $aaa * a + +$  according to the grammar of Exercise 4.5.2.

## 4.6 Introduction to LR Parsing: Simple LR

The most prevalent type of bottom-up parser today is based on a concept called LR(fc) parsing; the "L" is for left-to-right scanning of the input, the "R" for constructing a rightmost derivation in reverse, and the  $k$  for the number of input symbols of lookahead that are used in making parsing decisions. The cases  $k = 0$  or  $k = 1$  are of practical interest, and we shall only consider LR parsers with  $k < 1$  here. When ( $k$ ) is omitted,  $k$  is assumed to be 1.

This section introduces the basic concepts of LR parsing and the easiest method for constructing shift-reduce parsers, called "simple LR" (or SLR, for short). Some familiarity with the basic concepts is helpful even if the LR parser itself is constructed using an automatic parser generator. We begin with "items" and "parser states;" the diagnostic output from an LR parser generator typically includes parser states, which can be used to isolate the sources of parsing conflicts.

Section 4.7 introduces two, more complex methods — canonical-LR and LALR — that are used in the majority of LR parsers.

### 4.6.1 Why LR Parsers?

LR parsers are table-driven, much like the nonrecursive LL parsers of Section 4.4.4. A grammar for which we can construct a parsing table using one of the methods in this section and the next is said to be an *LR grammar*. Intuitively, for a grammar to be LR it is sufficient that a left-to-right shift-reduce parser be able to recognize handles of right-sentential forms when they appear on top of the stack.

LR parsing is attractive for a variety of reasons:

- LR parsers can be constructed to recognize virtually all programming-language constructs for which context-free grammars can be written. Non-LR context-free grammars exist, but these can generally be avoided for typical programming-language constructs.



- The LR-parsing method is the most general nonbacktracking shift-reduce parsing method known, yet it can be implemented as efficiently as other, more primitive shift-reduce methods (see the bibliographic notes).
- An LR parser can detect a syntactic error as soon as it is possible to do so on a left-to-right scan of the input.
- The class of grammars that can be parsed using LR methods is a proper superset of the class of grammars that can be parsed with predictive or LL methods. For a grammar to be LR(fc), we must be able to recognize the occurrence of the right side of a production in a right-sentential form, with  $k$  input symbols of lookahead. This requirement is far less stringent than that for LL(ife) grammars where we must be able to recognize the use of a production seeing only the first  $k$  symbols of what its right side derives. Thus, it should not be surprising that LR grammars can describe more languages than LL grammars.

The principal drawback of the LR method is that it is too much work to construct an LR parser by hand for a typical programming-language grammar. A specialized tool, an LR parser generator, is needed. Fortunately, many such generators are available, and we shall discuss one of the most commonly used ones, **Yacc**, in Section 4.9. Such a generator takes a context-free grammar and automatically produces a parser for that grammar. If the grammar contains ambiguities or other constructs that are difficult to parse in a left-to-right scan of the input, then the parser generator locates these constructs and provides detailed diagnostic messages.

## 4.6.2 Items and the LR(O) Automaton

How does a shift-reduce parser know when to shift and when to reduce? For example, with stack contents  $T$  and next input symbol  $*$  in Fig. 4.28, how does the parser know that  $T$  on the top of the stack is not a handle, so the appropriate action is to shift and not to reduce  $TtoEP$ .

An LR parser makes shift-reduce decisions by maintaining states to keep track of where we are in a parse. States represent sets of "items." An  $LR(0)$  item (item for short) of a grammar  $G$  is a production of  $G$  with a dot at some position of the body. Thus, production  $A \rightarrow XYZ$  yields the four items

$$\begin{array}{l} A \rightarrow \cdot XYZ \\ A \rightarrow X \cdot YZ \\ A \rightarrow XY \cdot Z \\ A \rightarrow XYZ \cdot \end{array}$$

The production  $A \rightarrow \bullet e$  generates only one item,  $A \rightarrow \bullet e$ .

Intuitively, an item indicates how much of a production we have seen at a given point in the parsing process. For example, the item  $A \rightarrow X \cdot YZ$  indicates that we hope to see a string derivable from  $XYZ$  next on the input. Item

## Representing Item Sets

A parser generator that produces a bottom-up parser may need to represent items and sets of items conveniently. Note that an item can be represented by a pair of integers, the first of which is the number of one of the productions of the underlying grammar, and the second of which is the position of the dot. Sets of items can be represented by a list of these pairs. However, as we shall see, the necessary sets of items often include "closure" items, where the dot is at the beginning of the body. These can always be reconstructed from the other items in the set, and we do not have to include them in the list.

$A \rightarrow XYZ$  indicates that we have just seen on the input a string derivable from  $X$  and that we hope next to see a string derivable from  $YZ$ . Item  $A \rightarrow XYZ$  indicates that we have seen the body  $XYZ$  and that it may be time to reduce  $XYZ$  to  $A$ .

One collection of sets of LR(0) items, called the *canonical LR(0) collection*, provides the basis for constructing a deterministic finite automaton that is used to make parsing decisions. Such an automaton is called an *LR(0) automaton*.<sup>3</sup> In particular, each state of the LR(0) automaton represents a set of items in the canonical LR(0) collection. The automaton for the expression grammar (4.1), shown in Fig. 4.31, will serve as the running example for discussing the canonical LR(0) collection for a grammar.

To construct the canonical LR(0) collection for a grammar, we define an augmented grammar and two functions, CLOSURE and GOTO. If  $G$  is a grammar with start symbol  $S$ , then  $G'$ , the *augmented grammar* for  $G$ , is  $G$  with a new start symbol  $S'$  and production  $S' \rightarrow S$ . The purpose of this new starting production is to indicate to the parser when it should stop parsing and announce acceptance of the input. That is, acceptance occurs when and only when the parser is about to reduce by  $S' \rightarrow S$ .

### Closure of Item Sets

If  $I$  is a set of items for a grammar  $G$ , then CLOSURE( $I$ ) is the set of items constructed from  $I$  by the two rules:

1. Initially, add every item in  $I$  to CLOSURE( $I$ ).
2. If  $A \rightarrow aB\beta$  is in CLOSURE( $J$ ) and  $B \rightarrow \gamma$  is a production, then add the item  $B \rightarrow \gamma$  to CLOSURE( $J$ ), if it is not already there. Apply this rule until no more new items can be added to CLOSURE( $J$ ).

<sup>3</sup> Technically, the automaton misses being deterministic according to the definition of Section 3.6.4, because we do not have a dead state, corresponding to the empty set of items. As a result, there are some state-input pairs for which no next state exists.

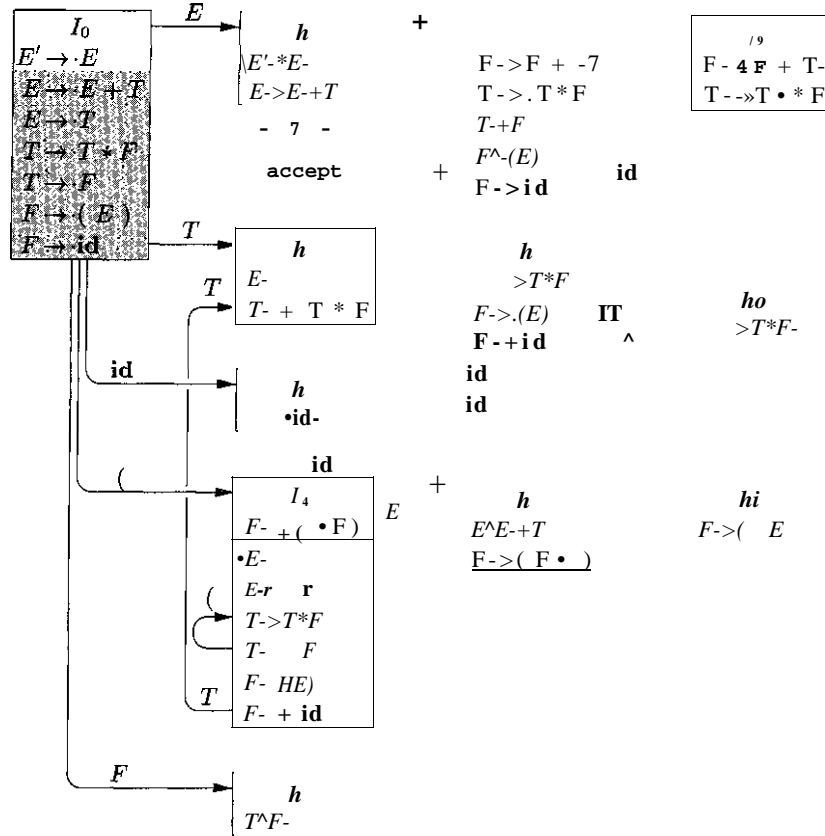

Figure 4.31: LR(0) automaton for the expression grammar (4.1)

Intuitively,  $A \rightarrow a-B/3$  in  $CLOSURE(Z)$  indicates that, at some point in the parsing process, we think we might next see a substring derivable from  $B/3$  as input. The substring derivable from  $B/5$  will have a prefix derivable from  $B$  by applying one of the  $\cdot \wedge$ -productions. We therefore add items for all the  $\cdot \wedge$ -productions; that is, if  $B \rightarrow \gamma$  is a production, we also include  $B \rightarrow \cdot \gamma$  in  $CLOSURE(J)$ .

Example 4.40: Consider the augmented expression grammar:

$$\begin{array}{lcl}
 E' & \rightarrow & E \\
 E & \rightarrow & E + T \quad | \quad T \\
 T & \rightarrow & T * F \quad | \quad F \\
 E & \rightarrow & ( E ) \quad | \quad id
 \end{array}$$

If  $I$  is the set of one item  $\{[E' \rightarrow \cdot E]\}$ , then  $CLOSURE(J)$  contains the set of items  $I_0$  in Fig. 4.31.

To see how the closure is computed,  $E' \rightarrow \bullet E$  is put in **CLOSURE**( $J$ ) by rule (1). Since there is an  $E$  immediately to the right of a dot, we add the  $E$ -productions with dots at the left ends:  $E \rightarrow \bullet E + T$  and  $E \rightarrow \bullet T$ . Now there is a  $T$  immediately to the right of a dot in the latter item, so we add  $T \rightarrow \bullet T * F$  and  $T \rightarrow \bullet F$ . Next, the  $F$  to the right of a dot forces us to add  $F \rightarrow \bullet (E)$  and  $F \rightarrow \bullet \text{id}$ , but no other items need to be added. •

The closure can be computed as in Fig. 4.32. A convenient way to implement the function *closure* is to keep a boolean array *added*, indexed by the nonterminals of  $G$ , such that *added*[ $B$ ] is set to **true** if and when we add the item  $B \rightarrow \bullet \gamma$  for each  $\wedge$ -production  $B \rightarrow \gamma$ .

```

SetOfItems CLOSURE (J) {
    J = I
    repeat
        for ( each item A → a-Bγ in J )
            for ( each production B → γ of G )
                if ( B → γ is not in J )
                    add B → γ to J;
    until no more items are added to J on one round;
    return J;
}

```

Figure 4.32: Computation of **CLOSURE**

Note that if one  $\wedge$ -production is added to the closure of  $I$  with the dot at the left end, then all  $\wedge$ -productions will be similarly added to the closure. Hence, it is not necessary in some circumstances actually to list the items  $B \rightarrow \bullet \gamma$  added to  $I$  by **CLOSURE**. A list of the nonterminals  $B$  whose productions were so added will suffice. We divide all the sets of items of interest into two classes:

1. *Kernel items*: the initial item,  $S' \rightarrow \bullet S$ , and all items whose dots are not at the left end.
2. *Nonkernel items*: all items with their dots at the left end, except for  $S' \rightarrow \bullet S$ .

Moreover, each set of items of interest is formed by taking the closure of a set of kernel items; the items added in the closure can never be kernel items, of course. Thus, we can represent the sets of items we are really interested in with very little storage if we throw away all nonkernel items, knowing that they could be regenerated by the closure process. In Fig. 4.31, nonkernel items are in the shaded part of the box for a state.

### The Function GOTO

The second useful function is  $\text{GOTO}(I, X)$  where  $I$  is a set of items and  $X$  is a grammar symbol.  $\text{GOTO}(I, X)$  is defined to be the closure of the set of all items  $[A \rightarrow aXfi]$  such that  $[A \rightarrow a \cdot X(3)]$  is in  $I$ . Intuitively, the GOTO function is used to define the transitions in the LR(0) automaton for a grammar. The states of the automaton correspond to sets of items, and  $\text{GOTO}(I, X)$  specifies the transition from the state for  $I$  under input  $X$ .

**Example 4.41:** If  $I$  is the set of two items  $\{[E' \rightarrow \epsilon? \cdot], [E \rightarrow \cdot E- + T]\}$ , then  $\text{GOTO}(I, +)$  contains the items

$$\begin{array}{l} E \rightarrow \cdot E- + T \\ T \rightarrow \cdot -T * F \\ T \rightarrow \cdot + F \\ F \rightarrow \cdot -(E) \\ F \rightarrow \cdot * \text{id} \end{array}$$

We computed  $\text{GOTO}(I, +)$  by examining  $I$  for items with  $+$  immediately to the right of the dot.  $E' \rightarrow \cdot E-$  is not such an item, but  $E \rightarrow \cdot E- + T$  is. We moved the dot over the  $+$  to get  $E \rightarrow \cdot E + T$  and then took the closure of this singleton set. •

We are now ready for the algorithm to construct  $C$ , the canonical collection of sets of LR(0) items for an augmented grammar  $G'$  — the algorithm is shown in Fig. 4.33.

```

void items( $G'$ ) {
     $C = \text{CLOSURE}(\{[S' \rightarrow \cdot \epsilon]\})$ ;
    repeat
        for ( each set of items  $I$  in  $C$  )
            for ( each grammar symbol  $X$  )
                if (  $\text{GOTO}(I, X)$  is not empty and not in  $C$  )
                    add  $\text{GOTO}(I, X)$  to  $C$ ;
    until no new sets of items are added to  $C$  on a round;
}

```

Figure 4.33: Computation of the canonical collection of sets of LR(0) items

**Example 4.42:** The canonical collection of sets of LR(0) items for grammar (4.1) and the GOTO function are shown in Fig. 4.31. GOTO is encoded by the transitions in the figure. •

**Use of the LR(0) Automaton**

The central idea behind "Simple LR," or SLR, parsing is the construction from the grammar of the LR(0) automaton. The states of this automaton are the sets of items from the canonical LR(0) collection, and the transitions are given by the `GOTO` function. The LR(0) automaton for the expression grammar (4.1) appeared earlier in Fig. 4.31.

The start state of the LR(0) automaton is  $\text{CLOSURE}(\{[S' \rightarrow \cdot S]\})$ , where  $S'$  is the start symbol of the augmented grammar. All states are accepting states. We say "state  $j$ " to refer to the state corresponding to the set of items  $I_j$ .

How can LR(0) automata help with shift-reduce decisions? Shift-reduce decisions can be made as follows. Suppose that the string  $7$  of grammar symbols takes the LR(0) automaton from the start state 0 to some state  $j$ . Then, shift on next input symbol  $a$  if state  $j$  has a transition on  $a$ . Otherwise, we choose to reduce; the items in state  $j$  will tell us which production to use.

The LR-parsing algorithm to be introduced in Section 4.6.3 uses its stack to keep track of states as well as grammar symbols; in fact, the grammar symbol can be recovered from the state, so the stack holds states. The next example gives a preview of how an LR(0) automaton and a stack of states can be used to make shift-reduce parsing decisions.

**Example 4.43:** Figure 4.34 illustrates the actions of a shift-reduce parser on input  $\text{id} * \text{id}$ , using the LR(0) automaton in Fig. 4.31. We use a stack to hold states; for clarity, the grammar symbols corresponding to the states on the stack appear in column `SYMBOLS`. At line (1), the stack holds the start state 0 of the automaton; the corresponding symbol is the bottom-of-stack marker  $\$$ .

LINE	STACK	SYMBOLS	INPUT	ACTION
(1)	0	$\$$	$\text{id} * \text{id} \$$	shift to 5
(2)	05	$\$ \text{id}$	$* \text{id} \$$	reduce by $F \rightarrow \text{id}$
(3)	03	$\$ F$	$* \text{id} \$$	reduce by $T \rightarrow \bullet F$
(4)	02	$\$ T$	$* \text{id} \$$	shift to 7
(5)	027	$\$ T^*$	$\text{id} \$$	shift to 5
(6)	0275	$\$ T^* \text{id}$	$\$$	reduce by $F \rightarrow \text{id}$
(?)	02710	$\$ T^* F$	$\$$	reduce by $T \rightarrow T^* F$
(8)	02	$\$ T$	$\$$	reduce by $E \rightarrow \bullet T$
(9)	01	$\$ E$	$\$$	accept

Figure 4.34: The parse of  $\text{id} * \text{id}$ 

The next input symbol is  $\text{id}$  and state 0 has a transition on  $\text{id}$  to state 5. We therefore shift. At line (2), state 5 (symbol  $\text{id}$ ) has been pushed onto the stack. There is no transition from state 5 on input  $*$ , so we reduce. From item  $[F \rightarrow \text{id} \cdot]$  in state 5, the reduction is by production  $F \rightarrow \text{id}$ .

With symbols, a reduction is implemented by popping the body of the production from the stack (on line (2), the body is **id**) and pushing the head of the production (in this case,  $F$ ). With states, we pop state 5 for symbol **id**, which brings state 0 to the top and look for a transition on  $F$ , the head of the production. In Fig. 4.31, state 0 has a transition on  $F$  to state 3, so we push state 3, with corresponding symbol  $F$ ; see line (3).

As another example, consider line (5), with state 7 (symbol  $*$ ) on top of the stack. This state has a transition to state 5 on input **id**, so we push state 5 (symbol **id**). State 5 has no transitions, so we reduce by  $F \rightarrow \mathbf{id}$ . When we pop state 5 for the body **id**, state 7 comes to the top of the stack. Since state 7 has a transition on  $F$  to state 10, we push state 10 (symbol  $F$ ). •

### 4.6.3 The LR-Parsing Algorithm

A schematic of an LR parser is shown in Fig. 4.35. It consists of an input, an output, a stack, a driver program, and a parsing table that has two parts (ACTION and GOTO). The driver program is the same for all LR parsers; only the parsing table changes from one parser to another. The parsing program reads characters from an input buffer one at a time. Where a shift-reduce parser would shift a symbol, an LR parser shifts a *state*. Each state summarizes the information contained in the stack below it.

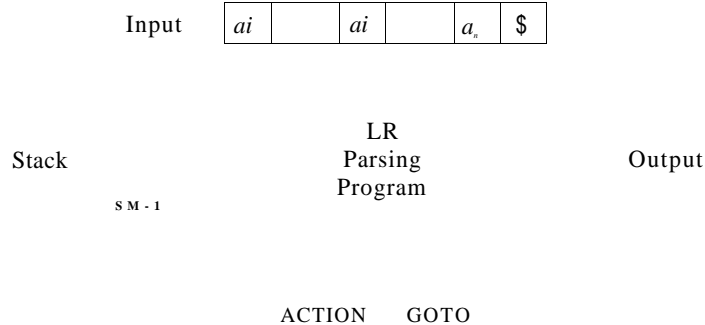

Figure 4.35: Model of an LR parser

The stack holds a sequence of states, so  $s_0 \wedge i \bullet \bullet \bullet s_n$ , where  $s_n$  is on top. In the SLR method, the stack holds states from the LR(0) automaton; the canonical-LR and LALR methods are similar. By construction, each state has a corresponding grammar symbol. Recall that states correspond to sets of items, and that there is a transition from state  $i$  to state  $j$  if  $GOTO(i, X) = j$ . All transitions to state  $j$  must be for the same grammar symbol  $X$ . Thus, each state, except the start state 0, has a unique grammar symbol associated with it.<sup>4</sup>

<sup>4</sup>The converse need not hold; that is, more than one state may have the same grammar

### Structure of the LR Parsing Table

The parsing table consists of two parts: a parsing-action function ACTION and a goto function GOTO.

1. The ACTION function takes as arguments a state  $i$  and a terminal  $a$  (or  $\$,$  the input endmarker). The value of ACTION[ $i,a$ ] can have one of four forms:
  - (a) Shift  $j$ , where  $j$  is a state. The action taken by the parser effectively shifts input  $a$  to the stack, but uses state  $j$  to represent  $a$ .
  - (b) Reduce  $A \rightarrow \beta$ . The action of the parser effectively reduces  $\beta$  on the top of the stack to head  $A$ .
  - (c) Accept. The parser accepts the input and finishes parsing.
  - (d) Error. The parser discovers an error in its input and takes some corrective action. We shall have more to say about how such error-recovery routines work in Sections 4.8.3 and 4.9.4.
2. We extend the GOTO function, defined on sets of items, to states: if GOTO[ $i, A$ ] =  $I_j$ , then GOTO also maps a state  $i$  and a nonterminal  $A$  to state  $j$ .

### LR-Parser Configurations

To describe the behavior of an LR parser, it helps to have a notation representing the complete state of the parser: its stack and the remaining input. A *configuration* of an LR parser is a pair:

$$[s_0 i \cdot \dots - S_m, \quad a_i O_i i \cdot \dots - a, \$]$$

where the first component is the stack contents (top on the right), and the second component is the remaining input. This configuration represents the right-sentential form

$$X_1 X_2 \cdot \dots X_m d_i C L_i + i \cdot \dots a,$$

in essentially the same way as a shift-reduce parser would; the only difference is that instead of grammar symbols, the stack holds states from which grammar symbols can be recovered. That is,  $X_i$  is the grammar symbol represented by state  $S_i$ . Note that  $s_0$ , the start state of the parser, does not represent a grammar symbol, and serves as a bottom-of-stack marker, as well as playing an important role in the parse.

symbol. See for example states 1 and 8 in the LR(0) automaton in Fig. 4.31, which are both entered by transitions on  $E$ , or states 2 and 9, which are both entered by transitions on  $T$ .



**Behavior of the LR Parser**

The next move of the parser from the configuration above is determined by reading  $a^*$ , the current input symbol, and  $s_m$ , the state on top of the stack, and then consulting the entry  $\text{ACTION}[s_m, a^*]$  in the parsing action table. The configurations resulting after each of the four types of move are as follows

1. If  $\text{ACTION}[s_m, a_i] = \text{shift } s$ , the parser executes a shift move; it shifts the next state  $s$  onto the stack, entering the configuration

$$(s, di \bullet \bullet -s, a_{i+1} \bullet \bullet -\circ, \$)$$

The symbol  $di$  need not be held on the stack, since it can be recovered from  $s$ , if needed (which in practice it never is). The current input symbol is now  $a_{i+1}$ .

2. If  $\text{ACTION}[s_m, a_i] = \text{reduce } A \rightarrow \beta$ , then the parser executes a reduce move, entering the configuration

$$(sosi \bullet \bullet \bullet s_{m-r}, s, didi+i \bullet \bullet \bullet a_i\%)$$

where  $r$  is the length of  $\beta$ , and  $s = \text{GOTO}[s_{m-r}, A]$ . Here the parser first popped  $r$  state symbols off the stack, exposing state  $s_{m-r}$ . The parser then pushed  $s$ , the entry for  $\text{GOTO}[s_{m-r}, A]$ , onto the stack. The current input symbol is not changed in a reduce move. For the LR parsers we shall construct,  $X_{m-r+i} \dots X_m$ , the sequence of grammar symbols corresponding to the states popped off the stack, will always match  $\beta$ , the right side of the reducing production.

The output of an LR parser is generated after a reduce move by executing the semantic action associated with the reducing production. For the time being, we shall assume the output consists of just printing the reducing production.

3. If  $\text{ACTION}[s_m, a_i] = \text{accept}$ , parsing is completed.
4. If  $\text{ACTION}[s_m, a_i] = \text{error}$ , the parser has discovered an error and calls an error recovery routine.

The LR-parsing algorithm is summarized below. All LR parsers behave in this fashion; the only difference between one LR parser and another is the information in the ACTION and GOTO fields of the parsing table.

**Algorithm 4.44:** LR-parsing algorithm.

**INPUT:** An input string  $w$  and an LR-parsing table with functions ACTION and GOTO for a grammar  $G$ .

**OUTPUT:** If  $w$  is in  $L(G)$ , the reduction steps of a bottom-up parse for  $w$ ; otherwise, an error indication.

**METHOD:** Initially, the parser has  $s_0$  on its stack, where  $s_0$  is the initial state, and  $w\$$  in the input buffer. The parser then executes the program in Fig. 4.36.

•

```

let  $a$  be the first symbol of  $w\$$ ;
while(1) { /* repeat forever */
  let  $s$  be the state on top of the stack;
  if ( ACTION $[s, a]$  = shift  $t$  ) {
    push  $t$  onto the stack;
    let  $a$  be the next input symbol;
  } else if ( ACTION  $[s, a]$  = reduce  $A$  (3) ) {
    pop  $|A|$  symbols off the stack;
    let state  $t$  now be on top of the stack;
    push GOTO $t, A$  onto the stack;
    output the production  $A \rightarrow ?$ ;
  } else if ( ACTION $[s, a]$  = accept ) break; /* parsing is done */
  else call error-recovery routine;
}

```

Figure 4.36: LR-parsing program

**Example 4.45:** Figure 4.37 shows the **ACTION** and **GOTO** functions of an LR-parsing table for the expression grammar (4.1), repeated here with the productions numbered:

(1) $E \rightarrow E + T$	(4) $T \rightarrow F$
(2) $E \rightarrow T$	(5) $F \rightarrow (E)$
(3) $T \rightarrow T * F$	(6) <b>F ^ i d</b>

The codes for the actions are:

1.  $si$  means shift and stack state  $z$ ,
2.  $rj$  means reduce by the production numbered  $j$ ,
3. acc means accept,
4. blank means error.

Note that the value of **GOTO** $[s, a]$  for terminal  $a$  is found in the **ACTION** field connected with the shift action on input  $a$  for state  $s$ . The **GOTO** field gives **GOTO** $s, A$  for nonterminals  $A$ . Although we have not yet explained how the entries for Fig. 4.37 were selected, we shall deal with this issue shortly.

STATE	ACTION						GOTO		
	id	+	*	(	)	\$	<i>E</i>	<i>T</i>	<i>F</i>
0	s5			s4			1	2	3
1		s6				acc			
2		r2	s7		r2	r2			
3		r4	r4		r4	r4			
4	s5			s4			8	2	3
5		r6	r6		r6	r6			
6	s5			s4				9	3
7	s5			s4					10
8		s6			s11				
9		r1	s7		r1	r1			
10		r3	r3		r3	r3			
11		r5	r5		r5	r5			

Figure 4.37: Parsing table for expression grammar

On input **id \* id + id**, the sequence of stack and input contents is shown in Fig. 4.38. Also shown for clarity, are the sequences of grammar symbols corresponding to the states held on the stack. For example, at line (1) the LR parser is in state 0, the initial state with no grammar symbol, and with **id** the first input symbol. The action in row 0 and column **id** of the action field of Fig. 4.37 is s5, meaning shift by pushing state 5. That is what has happened at line (2): the state symbol 5 has been pushed onto the stack, and **id** has been removed from the input.

Then, \* becomes the current input symbol, and the action of state 5 on input \* is to reduce by *F* **id**. One state symbol is popped off the stack. State 0 is then exposed. Since the goto of state 0 on *F* is 3, state 3 is pushed onto the stack. We now have the configuration in line (3). Each of the remaining moves is determined similarly. •

#### 4.6.4 Constructing SLR-Parsing Tables

The SLR method for constructing parsing tables is a good starting point for studying LR parsing. We shall refer to the parsing table constructed by this method as an SLR table, and to an LR parser using an SLR-parsing table as an SLR parser. The other two methods augment the SLR method with lookahead information.

The SLR method begins with LR(0) items and LR(0) automata, introduced in Section 4.5. That is, given a grammar, *G*, we augment *G* to produce *G'*, with a new start symbol *S'*. From *G'*, we construct *C*, the canonical collection of sets of items for *G'* together with the GOTO function.

	STACK	SYMBOLS	INPUT	ACTION
(1)	0		<b>id * id + id \$</b>	shift
(2)	0 5	<b>id</b>	<b>* id + id \$</b>	reduce by $F \rightarrow \mathbf{id}$
(3)	0 3	$F$	<b>* id -  id \$</b>	reduce by $T \rightarrow + F$
(4)	0 2	$T$	<b>* id + id \$</b>	shift
(5)	0 2 7	$T^*$	<b>id + id \$</b>	shift
(6)	0 2 7 5	<b><math>T^* \mathbf{id}</math></b>	<b>+ id \$</b>	reduce by $F \rightarrow \mathbf{id}$
(?)	0 2 7 10	$T^* F$	<b>+ id \$</b>	reduce by $T \rightarrow \bullet T^* F$
(8)	0 2	$T$	<b>+ id \$</b>	reduce by $E \rightarrow \cancel{+} T$
(9)	0 1	$E$	<b>+ id \$</b>	shift
(10)	0 1 6	$E +$	<b>id \$</b>	shift
(11)	0 1 6 5	$E + \mathbf{id}$	<b>\$</b>	reduce by $F \rightarrow \mathbf{id}$
(12)	0 1 6 3	$E + F$	<b>\$</b>	reduce by $T \rightarrow \mathbf{+} F$
(13)	0 1 6 9	$E + T$	<b>\$</b>	reduce by $E \rightarrow E + T$
(14)	0 1	$E$	<b>\$</b>	accept

Figure 4.38: Moves of an LR parser on  $\mathbf{id * id + id}$ 

The ACTION and GOTO entries in the parsing table are then constructed using the following algorithm. It requires us to know FOLLOW(A) for each nonterminal A of a grammar (see Section 4.4).

**Algorithm 4.46:** Constructing an SLR-parsing table.

**INPUT:** An augmented grammar  $G'$ .

**OUTPUT:** The SLR-parsing table functions ACTION and GOTO for  $G'$ .

**METHOD:**

1. Construct  $C = \{I_0, I_1, \dots, I_n\}$ , the collection of sets of LR(0) items for  $G'$ .
2. State  $i$  is constructed from  $I_i$ . The parsing actions for state  $i$  are determined as follows:
  - (a) If  $[A \rightarrow a \cdot a^3]$  is in  $I_i$  and  $\text{GOTO}(I_j, a) = I_j$ , then set  $\text{ACTION}[z, a]$  to "shift  $j$  ." Here  $a$  must be a terminal.
  - (b) If  $[A \rightarrow y a \cdot]$  is in  $I_i$ , then set  $\text{ACTION}[i, a]$  to "reduce  $A \rightarrow \bullet a$ " for all  $a$  in  $\text{FOLLOW}(v_1)$ ; here  $A$  may not be  $S'$ .
  - (c) If  $[S' \rightarrow t S \cdot]$  is in  $I_i$ , then set  $\text{ACTION}[z, \$]$  to "accept."

If any conflicting actions result from the above rules, we say the grammar is not SLR(1). The algorithm fails to produce a parser in this case.

3. The goto transitions for state  $i$  are constructed for all nonterminals  $A$  using the rule: If  $GOTO(i,A) = I_j$ , then  $GOTO[i, A] = j$ .
4. All entries not defined by rules (2) and (3) are made "error."
5. The initial state of the parser is the one constructed from the set of items containing  $[S' \rightarrow \bullet -S]$ .

•

The parsing table consisting of the ACTION and GOTO functions determined by Algorithm 4.46 is called the *SLR(1) table for  $G$* . An LR parser using the SLR(1) table for  $G$  is called the SLR(1) parser for  $G$ , and a grammar having an SLR(1) parsing table is said to be *SLR(1)*. We usually omit the "(1)" after the "SLR," since we shall not deal here with parsers having more than one symbol of lookahead.

Example 4.47: Let us construct the SLR table for the augmented expression grammar. The canonical collection of sets of LR(0) items for the grammar was shown in Fig. 4.31. First consider the set of items  $I_0$ :

$$\begin{array}{l} E' \quad E \\ E \rightarrow -E + T \\ E \rightarrow -T \\ T \rightarrow -T * F \\ T \quad F \\ F \quad -(E) \\ F \rightarrow \bullet \text{ id} \end{array}$$

The item  $F \quad -(E)$  gives rise to the entry  $\text{ACTION}[0, (] = \text{shift } 4$ , and the item  $F \rightarrow \bullet \text{ id}$  to the entry  $\text{ACTION}[0, \text{id}] = \text{shift } 5$ . Other items in  $J_0$  yield no actions. Now consider  $I_1$ :

$$\begin{array}{l} E' \rightarrow E \neg \\ E \rightarrow * E \neg + T \end{array}$$

The first item yields  $\text{ACTION}[1, \$] = \text{accept}$ , and the second yields  $\text{ACTION}[1, +] = \text{shift } 6$ . Next consider  $I_2$ :

$$\begin{array}{l} E \rightarrow \neg T \neg \\ T \rightarrow + T * F \end{array}$$

Since  $\text{FOLLOW}(E) = \{\$, +, \cdot\}$ , the first item makes

$$\text{ACTION}[2, \$] = \text{ACTION}[2, +] = \text{ACTION}[2, \cdot] = \text{reduce } E \rightarrow T$$

The second item makes  $\text{ACTION}[2, *] = \text{shift } 7$ . Continuing in this fashion we obtain the ACTION and GOTO tables that were shown in Fig. 4.31. In that figure, the numbers of productions in reduce actions are the same as the order in which they appear in the original grammar (4.1). That is,  $E \rightarrow E + T$  is number 1,  $E \rightarrow T$  is 2, and so on. •

Example 4.48: Every SLR(1) grammar is unambiguous, but there are many unambiguous grammars that are not SLR(1). Consider the grammar with productions

$$\begin{array}{l} S \rightarrow L = R \mid R \\ L \rightarrow *R \mid \text{id} \\ R \rightarrow \bullet L \end{array} \quad (4.49)$$

Think of  $L$  and  $R$  as standing for  $l$ -value and  $r$ -value, respectively, and  $*$  as an operator indicating "contents of."<sup>5</sup> The canonical collection of sets of LR(0) items for grammar (4.49) is shown in Fig. 4.39.

$$\begin{array}{ll} I_0: & S' \rightarrow \bullet S \\ & S \rightarrow L = R \\ & S \wedge R \\ & L \rightarrow \bullet * R \\ & L \rightarrow * \text{id} \\ & R \rightarrow + L \\ \\ h: & S' \rightarrow S \bullet \\ \\ I_1: & S \rightarrow * L \bullet = R \\ & R \wedge L \\ \\ h: & S \rightarrow + R \bullet \\ \\ h: & L \rightarrow * \bullet R \\ & R \wedge L \\ & L \rightarrow * R \\ & L \quad \text{id} \\ \\ I_2: & L \rightarrow \text{id} \bullet \\ \\ I_3: & S \rightarrow L = \bullet R \\ & R \wedge L \\ & L \rightarrow t * R \\ & L \rightarrow \text{id} \\ \\ I_4: & L \rightarrow + * R \bullet \\ \\ I_5: & R \rightarrow + L \bullet \\ \\ h: & S \rightarrow + L = R \bullet \end{array}$$

Figure 4.39: Canonical LR(0) collection for grammar (4.49)

Consider the set of items  $I_2$ . The first item in this set makes ACTION[2, =] be "shift 6." Since FOLLOW(JR) contains = (to see why, consider the derivation  $S \rightarrow L = R \rightarrow *R = R$ ), the second item sets ACTION[2, =] to "reduce  $R \rightarrow L$ ." Since there is both a shift and a reduce entry in ACTION[2, =], state 2 has a shift/reduce conflict on input symbol =.

Grammar (4.49) is not ambiguous. This shift/reduce conflict arises from the fact that the SLR parser construction method is not powerful enough to remember enough left context to decide what action the parser should take on input =, having seen a string reducible to  $L$ . The canonical and LALR methods, to be discussed next, will succeed on a larger collection of grammars, including

<sup>5</sup>As in Section 2.8.3, an  $l$ -value designates a location and an  $r$ -value is a value that can be stored in a location.

grammar (4.49). Note, however, that there are unambiguous grammars for which every LR parser construction method will produce a parsing action table with parsing action conflicts. Fortunately, such grammars can generally be avoided in programming language applications. •

### 4.6.5 Viable Prefixes

Why can LR(0) automata be used to make shift-reduce decisions? The LR(0) automaton for a grammar characterizes the strings of grammar symbols that can appear on the stack of a shift-reduce parser for the grammar. The stack contents must be a prefix of a right-sentential form. If the stack holds  $a$  and the rest of the input is  $x$ , then a sequence of reductions will take  $ax$  to  $S$ . In terms of derivations,  $S \xrightarrow{rm} ax$ .

Not all prefixes of right-sentential forms can appear on the stack, however, since the parser must not shift past the handle. For example, suppose

$$\#4 \quad F * id = > \quad (E) * id$$

$rm \qquad \qquad \qquad rm$

Then, at various times during the parse, the stack will hold  $($ ,  $(E$ , and  $(E)$ , but it must not hold  $(E)*$ , since  $(E)$  is a handle, which the parser must reduce to  $F$  before shifting  $*$ .

The prefixes of right sentential forms that can appear on the stack of a shift-reduce parser are called *viable prefixes*. They are defined as follows: a viable prefix is a prefix of a right-sentential form that does not continue past the right end of the rightmost handle of that sentential form. By this definition, it is always possible to add terminal symbols to the end of a viable prefix to obtain a right-sentential form.

SLR parsing is based on the fact that LR(0) automata recognize viable prefixes. We say item  $A \rightarrow fa-fa$  is *valid* for a viable prefix  $a fa$  if there is a derivation  $S' \xrightarrow{rm} a Aw \Rightarrow afaaw$ . In general, an item will be valid for many viable prefixes.

The fact that  $A \rightarrow fa-fa$  is valid for  $a fa$  tells us a lot about whether to shift or reduce when we find  $a fa$  on the parsing stack. In particular, if  $fa \wedge e$ , then it suggests that we have not yet shifted the handle onto the stack, so shift is our move. If  $fa = \bullet e$ , then it looks as if  $A \rightarrow \bullet fa$  is the handle, and we should reduce by this production. Of course, two valid items may tell us to do different things for the same viable prefix. Some of these conflicts can be resolved by looking at the next input symbol, and others can be resolved by the methods of Section 4.8, but we should not suppose that all parsing action conflicts can be resolved if the LR method is applied to an arbitrary grammar.

We can easily compute the set of valid items for each viable prefix that can appear on the stack of an LR parser. In fact, it is a central theorem of LR-parsing theory that the set of valid items for a viable prefix  $\gamma$  is exactly the set of items reached from the initial state along the path labeled  $\gamma$  in the LR(0) automaton for the grammar. In essence, the set of valid items embodies

### Items as States of an NFA

A nondeterministic finite automaton  $N$  for recognizing viable prefixes can be constructed by treating the items themselves as states. There is a transition from  $A \rightarrow aX\beta$  to  $A \rightarrow aXj\beta$  labeled  $X$ , and there is a transition from  $A \rightarrow aBj\beta$  to  $B \rightarrow -j$  labeled  $\epsilon$ . Then  $CLOSURE(J)$  for set of items (states of  $N$ )  $I$  is exactly the  $\epsilon$ -closure of a set of NFA states defined in Section 3.7.1. Thus,  $GOTO(I, X)$  gives the transition from  $I$  on symbol  $X$  in the DFA constructed from  $N$  by the subset construction. Viewed in this way, the procedure  $items(G')$  in Fig. 4.33 is just the subset construction itself applied to the NFA  $N$  with items as states.

all the useful information that can be gleaned from the stack. While we shall not prove this theorem here, we shall give an example.

Example 4.50: Let us consider the augmented expression grammar again, whose sets of items and GOTO function are exhibited in Fig. 4.31. Clearly, the string  $E + T^*$  is a viable prefix of the grammar. The automaton of Fig. 4.31 will be in state 7 after having read  $E + T^*$ . State 7 contains the items

$$\begin{aligned} T &\rightarrow T^* -F \\ F &\rightarrow -(E) \\ F &\rightarrow id \end{aligned}$$

which are precisely the items valid for  $E+T^*$ . To see why, consider the following three rightmost derivations

$$\begin{array}{ccc} E' & E & E' & E & E' & E \\ \text{rm} & & \text{rm} & & \text{rm} & \\ & E+T & & E + T & => & E + T \\ \text{rm} & & \text{rm} & & \text{rm} & \\ & E + T *F & & E + T*F & & E + T*F \\ \text{rm} & & \text{rm} & & \text{rm} & \end{array}$$

The first derivation shows the validity of  $T \rightarrow T^* -F$ , the second the validity of  $F \rightarrow -(E)$ , and the third the validity of  $F \rightarrow id$ . It can be shown that there are no other valid items for  $E + T^*$ , although we shall not prove that fact here.

### 4.6.6 Exercises for Section 4.6

Exercise 4.6.1: Describe all the viable prefixes for the following grammars:

- a) The grammar  $S \rightarrow 0S1 \mid 01$  of Exercise 4.2.2(a).



! b) The grammar  $S \rightarrow S S + \mid S S * \mid a$  of Exercise 4.2.1.

! c) The grammar  $S \rightarrow S ( S ) \mid e$  of Exercise 4.2.2(c).

**Exercise 4.6.2:** Construct the SLR sets of items for the (augmented) grammar of Exercise 4.2.1. Compute the GOTO function for these sets of items. Show the parsing table for this grammar. Is the grammar SLR?

**Exercise 4.6.3:** Show the actions of your parsing table from Exercise 4.6.2 on the input  $aa * a+$ .

**Exercise 4.6.4:** For each of the (augmented) grammars of Exercise 4.2.2(a)-(g):

- Construct the SLR sets of items and their GOTO function.
- Indicate any action conflicts in your sets of items.
- Construct the SLR-parsing table, if one exists.

**Exercise 4.6.5:** Show that the following grammar:

$$\begin{array}{lcl} S & \rightarrow & Aa \mid Ab \mid B \mid b \mid B a \\ A & \rightarrow & \bullet e \\ B & \rightarrow & e \end{array}$$

is LL(1) but *not* SLR(1).

**Exercise 4.6.6:** Show that the following grammar:

$$\begin{array}{lcl} S & \rightarrow & S A \mid A \\ A & \rightarrow & \bullet a \end{array}$$

is SLR(1) but not LL(1).

**!! Exercise 4.6.7:** Consider the family of grammars  $G_n$  defined by:

$$\begin{array}{lcl} S & \rightarrow & A_i b_i \quad \text{for } 1 < i < n \\ A_i & \rightarrow & a_j A_i \mid a_j \quad \text{for } 1 < i, j < n \text{ and } i \neq j \end{array}$$

Show that:

- $G_n$  has  $2n^2 - n$  productions.
- $G_n$  has  $2^n + n^2 + n$  sets of LR(0) items.
- $G_n$  is SLR(1).

What does this analysis say about how large LR parsers can get?

! Exercise 4.6.8: We suggested that individual items could be regarded as states of a nondeterministic finite automaton, while sets of valid items are the states of a deterministic finite automaton (see the box on "Items as States of an NFA" in Section 4.6.5). For the grammar  $S \rightarrow S S + \mid S S * \mid a$  of Exercise 4.2.1:

- a) Draw the transition diagram (NFA) for the valid items of this grammar according to the rule given in the box cited above.
- b) Apply the subset construction (Algorithm 3.20) to your NFA from part (a). How does the resulting DFA compare to the set of LR(0) items for the grammar?

!! c) Show that in all cases, the subset construction applied to the NFA that comes from the valid items for a grammar produces the LR(0) sets of items.

! Exercise 4.6.9: The following is an ambiguous grammar:

$$\begin{array}{l} S \rightarrow AS \mid b \\ A \rightarrow \epsilon \mid SA \mid a \end{array}$$

Construct for this grammar its collection of sets of LR(0) items. If we try to build an LR-parsing table for the grammar, there are certain conflicting actions. What are they? Suppose we tried to use the parsing table by nondeterministically choosing a possible action whenever there is a conflict. Show all the possible sequences of actions on input *abab*.

## 4.7 More Powerful LR Parsers

In this section, we shall extend the previous LR parsing techniques to use one symbol of lookahead on the input. There are two different methods:

1. The "canonical-LR" or just "LR" method, which makes full use of the lookahead symbol(s). This method uses a large set of items, called the LR(1) items.
2. The "lookahead-LR" or "LALR" method, which is based on the LR(0) sets of items, and has many fewer states than typical parsers based on the LR(1) items. By carefully introducing lookaheads into the LR(0) items, we can handle many more grammars with the LALR method than with the SLR method, and build parsing tables that are no bigger than the SLR tables. LALR is the method of choice in most situations.

After introducing both these methods, we conclude with a discussion of how to compact LR parsing tables for environments with limited memory.

### 4.7.1 Canonical LR(1) Items

We shall now present the most general technique for constructing an LR parsing table from a grammar. Recall that in the SLR method, state  $i$  calls for reduction by  $A \rightarrow a$  if the set of items  $I^*$  contains item  $[A \rightarrow a]$  and  $a$  is in  $\text{FOLLOW}(A)$ . In some situations, however, when state  $i$  appears on top of the stack, the viable prefix  $\beta a$  on the stack is such that  $\beta A$  cannot be followed by  $a$  in any right-sentential form. Thus, the reduction by  $A \rightarrow a$  should be invalid on input  $a$ .

Example 4.51: Let us reconsider Example 4.48, where in state 2 we had item  $R \rightarrow IT$ , which could correspond to  $A \rightarrow a$  above, and  $a$  could be the  $=$  sign, which is in  $\text{FOLLOW}(E)$ . Thus, the SLR parser calls for reduction by  $R \rightarrow L$  in state 2 with  $=$  as the next input (the shift action is also called for, because of item  $S \rightarrow L=R$  in state 2). However, there is no right-sentential form of the grammar in Example 4.48 that begins  $R = \dots$ . Thus state 2, which is the state corresponding to viable prefix  $L$  only, should not really call for reduction of that  $L$  to  $R$ . •

It is possible to carry more information in the state that will allow us to rule out some of these invalid reductions by  $A \rightarrow a$ . By splitting states when necessary, we can arrange to have each state of an LR parser indicate exactly which input symbols can follow a handle  $a$  for which there is a possible reduction to  $A$ .

The extra information is incorporated into the state by redefining items to include a terminal symbol as a second component. The general form of an item becomes  $[A \rightarrow a \cdot \beta, a]$ , where  $A \rightarrow a\beta$  is a production and  $a$  is a terminal or the right endmarker  $\$$ . We call such an object an *LR(1) item*. The 1 refers to the length of the second component, called the *lookahead* of the item.<sup>6</sup> The lookahead has no effect in an item of the form  $[A \rightarrow a(\beta, a)]$ , where  $\beta$  is not  $\epsilon$ , but an item of the form  $[A \rightarrow a \cdot, a]$  calls for a reduction by  $A \rightarrow a$  only if the next input symbol is  $a$ . Thus, we are compelled to reduce by  $A \rightarrow a$  only on those input symbols  $a$  for which  $[A \rightarrow a \cdot, a]$  is an LR(1) item in the state on top of the stack. The set of such  $a$ 's will always be a subset of  $\text{FOLLOW}(A)$ , but it could be a proper subset, as in Example 4.51.

Formally, we say LR(1) item  $[A \rightarrow a(\beta, a)]$  is *valid* for a viable prefix  $\gamma$  if there is a derivation  $S \xrightarrow{*} \alpha A w$   $\xrightarrow{*} \gamma a \alpha w$ , where

1.  $\gamma = \alpha a$ , and
2. Either  $a$  is the first symbol of  $w$ , or  $w$  is  $\epsilon$  and  $a$  is  $\$$ .

Example 4.52: Let us consider the grammar

<sup>6</sup>Lookaheads that are strings of length greater than one are possible, of course, but we shall not consider such lookaheads here.

$$\begin{array}{l} S \rightarrow B \quad B \\ B \rightarrow aB \quad | \quad b \end{array}$$

There is a rightmost derivation  $S \Rightarrow_{\text{rm}} aaBab \xRightarrow{\text{rm}} aaaBab$ . We see that item  $[S \rightarrow a-B, a]$  is valid for a viable prefix  $\gamma = aaa$  by letting  $\delta = aa$ ,  $A = B$ ,  $w = ab$ ,  $a = a$ , and  $\beta = \delta$  in the above definition. There is also a rightmost derivation  $S \xRightarrow{\text{rm}} BaB \xRightarrow{\text{rm}} BaaB$ . From this derivation we see that item  $[B \rightarrow a-B, \$]$  is valid for viable prefix  $Baa$ . •

### 4.7.2 Constructing LR(1) Sets of Items

The method for building the collection of sets of valid LR(1) items is essentially the same as the one for building the canonical collection of sets of LR(0) items. We need only to modify the two procedures CLOSURE and GOTO.

```

SetOfItems CLOSURE(J) {
    repeat
        for ( each item [A ->• a-B(β, a] in I )
            for ( each production B -> γ in G' )
                for ( each terminal β in FIRST(γa) )
                    add [B -> -γ, β] to set I;
    until no more items are added to I;
    return I;
}

SetOfItems GOTO(Z, X) {
    initialize J to be the empty set;
    for ( each item [A -> a-X(β, a] in Z )
        add item [A -> aX-β(β, a] to set J;
    return CLOSURE(J);
}

void items(G') {
    initialize C to CLOSURE({ [S' ->• -S, $] });
    repeat
        for ( each set of items I in C )
            for ( each grammar symbol X )
                if ( GOTO(I, X) is not empty and not in C )
                    add GOTO(I, X) to C;
    until no new sets of items are added to C;
}

```

Figure 4.40: Sets-of-LR(1)-items construction for grammar  $G'$

To appreciate the new definition of the CLOSURE operation, in particular, why  $b$  must be in  $FIRST(\delta a)$ , consider an item of the form  $[A \rightarrow a-Bft, a]$  in the set of items valid for some viable prefix  $\gamma$ . Then there is a rightmost derivation  $S \xRightarrow{rm} \delta Aax \Rightarrow \delta aBflax$ , where  $\gamma = \delta a$ . Suppose  $flax$  derives terminal string  $by$ . Then for each production of the form  $B \rightarrow r$  for some  $rj$ , we have derivation  $S \xRightarrow{rm} \gamma Bby \Rightarrow \gamma nby$ . Thus,  $[B \rightarrow -n, b]$  is valid for  $\gamma$ . Note that  $b$  can be the first terminal derived from  $ft$ , or it is possible that  $ft$  derives  $\epsilon$  in the derivation  $flax$  by, and  $\delta$  can therefore be  $a$ . To summarize both possibilities we say that  $b$  can be any terminal in  $FIRST(Pax)$ , where  $FIRST$  is the function from Section 4.4. Note that  $x$  cannot contain the first terminal of  $by$ , so  $FIRST(Pax) = FIRST_{\epsilon}(\delta a)$ . We now give the LR(1) sets of items construction.

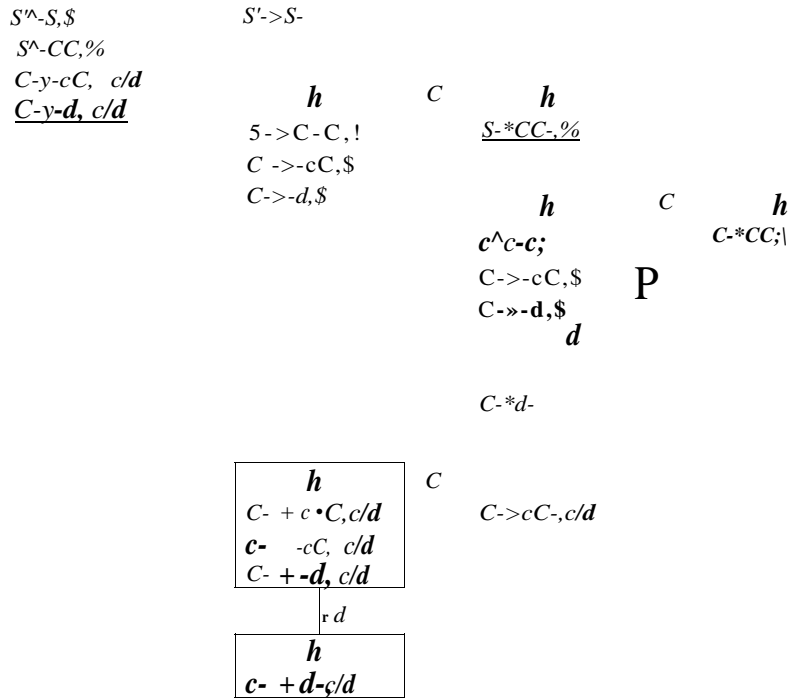

Figure 4.41: The GOTO graph for grammar (4.55)

Algorithm 4.53: Construction of the sets of LR(1) items.

**INPUT:** An augmented grammar  $G'$ .

**OUTPUT:** The sets of LR(1) items that are the set of items valid for one or more viable prefixes of  $G'$ .

**METHOD:** The procedures **CLOSURE** and **GOTO** and the main routine *items* for constructing the sets of items were shown in Fig. 4.40. •

Example 4.54: Consider the following augmented grammar.

$$\begin{array}{l} S' \quad S \\ S \quad CC \\ C \rightarrow cC \mid d \end{array} \quad (4.55)$$

We begin by computing the closure of  $\{[S' \rightarrow \cdot S, \$]\}$ . To close, we match the item  $[S' \rightarrow \cdot S, \$]$  with the item  $[A \rightarrow aBj\beta, a]$  in the procedure **CLOSURE**. That is,  $A = S'$ ,  $a = \epsilon$ ,  $S = S$ ,  $\beta = \epsilon$ , and  $a = \$$ . Function **CLOSURE** tells us to add  $[B \rightarrow \cdot \beta]$  for each production  $B \rightarrow \beta$  and terminal  $\&$  in **FIRST** (3a). In terms of the present grammar,  $B \rightarrow \beta$  must be  $S \rightarrow CC$ , and since  $\beta$  is  $\epsilon$  and  $a$  is  $\&$ ,  $b$  may only be  $\&$ . Thus we add  $[S \rightarrow \cdot CC, \$]$ .

We continue to compute the closure by adding all items  $[C \rightarrow \cdot \beta]$  for  $\beta$  in **FIRST**( $C\$$ ). That is, matching  $[S \rightarrow \cdot CC, \$]$  against  $[A \rightarrow \cdot a]$ , we have  $A = S$ ,  $a = \epsilon$ ,  $B = C$ ,  $\beta = C$ , and  $a = \$$ . Since  $C$  does not derive the empty string, **FIRST**( $C\$$ ) = **FIRST**( $C$ ). Since **FIRST**( $C$ ) contains terminals  $c$  and  $d$ , we add items  $[C \rightarrow \cdot cC, c]$ ,  $[C \rightarrow \cdot cC, d]$ ,  $[C \rightarrow \cdot d, c]$  and  $[C \rightarrow \cdot d, d]$ . None of the new items has a nonterminal immediately to the right of the dot, so we have completed our first set of LR(1) items. The initial set of items is

$$\begin{array}{l} IQ : \quad S \rightarrow \cdot S, \$ \\ \quad S \rightarrow \cdot CC, \$ \\ \quad C \rightarrow \cdot cC, c/d \\ \quad C \rightarrow \cdot d, c/d \end{array}$$

The brackets have been omitted for notational convenience, and we use the notation  $[C \rightarrow \cdot cC, c/d]$  as a shorthand for the two items  $[C \rightarrow \cdot cC, c]$  and  $[C \rightarrow \cdot cC, d]$ .

Now we compute **GOTO**( $J_i, X$ ) for the various values of  $X$ . For  $X = S$  we must close the item  $[S' \rightarrow \cdot S, \$]$ . No additional closure is possible, since the dot is at the right end. Thus we have the next set of items

$$h: \quad S' \rightarrow S \cdot, \$$$

For  $X = C$  we close  $[S \rightarrow \cdot CC, \$]$ . We add the  $C$ -productions with second component  $\&$  and then can add no more, yielding

$$\begin{array}{l} h: \quad S \rightarrow C \cdot C, \$ \\ \quad C \rightarrow \cdot cC, \$ \\ \quad C \rightarrow \cdot d, \$ \end{array}$$

Next, let  $X = c$ . We must close  $\{[C \rightarrow \cdot cC, c/d]\}$ . We add the  $C$ -productions with second component  $c/d$ , yielding

$$\begin{aligned}
 h: \quad & C \quad c-C, \quad c/d \\
 & C \rightarrow \bullet -cC, \quad c/d \\
 & C \rightarrow -d, \quad c/d
 \end{aligned}$$

Finally, let  $X = d$ , and we wind up with the set of items

$$h \bullet * \quad C \rightsquigarrow d-, \quad c/d$$

We have finished considering GOTO on  $I_6$ . We get no new sets from  $I_{11}$ , but  $h$  has goto's on  $C$ ,  $c$ , and  $d$ . For  $\text{GOTO}(7_3, C)$  we get

$$I_5: \quad S \rightarrow +CC-, \$$$

no closure being needed. To compute  $\text{GOTO}(I_2, c)$  we take the closure of  $\{[C \quad c-C, \$]\}$ , to obtain

$$\begin{aligned}
 J_6: \quad & C \quad c-C, \quad \$ \\
 & C \quad -cC, \quad \$ \\
 & C \rightarrow -d, \quad \$
 \end{aligned}$$

Note that  $I_6$  differs from  $I_3$  only in second components. We shall see that it is common for several sets of LR(1) items for a grammar to have the same first components and differ in their second components. When we construct the collection of sets of LR(0) items for the same grammar, each set of LR(0) items will coincide with the set of first components of one or more sets of LR(1) items. We shall have more to say about this phenomenon when we discuss LALR parsing.

Continuing with the GOTO function for  $J_6$ ,  $\text{GOTO}(J_6, d)$  is seen to be

$$h: \quad C \rightarrow +d; \quad \$$$

Turning now to  $7_3$ , the GOTO's of  $I_3$  on  $c$  and  $d$  are  $I_5$  and  $h$ , respectively, and  $\text{GOTO}(7_3, C)$  is

$$I_7: \quad C \quad cC-, \quad c/d$$

$7_4$  and  $h$  have no GOTO's, since all items have their dots at the right end. The GOTO's of  $I_6$  on  $c$  and  $d$  are  $I_6$  and  $I_7$ , respectively, and  $\text{GOTO}(7_6, C)$  is

$$7_9: \quad C \rightarrow cO; \quad \$$$

The remaining sets of items yield no GOTO's, so we are done. Figure 4.41 shows the ten sets of items with their goto's. •

### 4.7.3 Canonical LR(1) Parsing Tables

We now give the rules for constructing the LR(1) ACTION and GOTO functions from the sets of LR(1) items. These functions are represented by a table, as before. The only difference is in the values of the entries.

Algorithm 4.56: Construction of canonical-LR parsing tables.

**INPUT:** An augmented grammar  $G'$ .

**OUTPUT:** The canonical-LR parsing table functions ACTION and GOTO for  $G'$ .

**METHOD:**

1. Construct  $C' = \{I_q, h, \dots, I_n\}$ , the collection of sets of LR(1) items for  $G'$
2. State  $i$  of the parser is constructed from  $I_i$ . The parsing action for state  $i$  is determined as follows.
  - (a) If  $[A \rightarrow a-a(3,b)]$  is in  $I_i$  and  $\text{GOTO}(2\sim, a) = I_j$ , then set  $\text{ACTION}[i, a]$  to "shift  $j$  ." Here  $a$  must be a terminal.
  - (b) If  $[A \rightarrow \bullet a-, a]$  is in  $I_i$ ,  $A \wedge S'$ , then set  $\text{ACTION}[\llcorner, a]$  to "reduce  $A \rightarrow a$ ."
  - (c) If  $[S' \rightarrow \bullet S-, \$]$  is in  $I_i$ , then set  $\text{ACTION}[\wedge, \$]$  to "accept."

If any conflicting actions result from the above rules, we say the grammar is not LR(1). The algorithm fails to produce a parser in this case.

3. The goto transitions for state  $i$  are constructed for all nonterminals  $A$  using the rule: If  $\text{GOTO}(ij, A) = I_j$ , then  $\text{GOTO}[z, A] = j$ .
4. All entries not defined by rules (2) and (3) are made "error."
5. The initial state of the parser is the one constructed from the set of items containing  $[S' \rightarrow \bullet -S, \$]$ .

The table formed from the parsing action and goto functions produced by Algorithm 4.44 is called the *canonical* LR(1) parsing table. An LR parser using this table is called a canonical-LR(1) parser. If the parsing action function has no multiply defined entries, then the given grammar is called an *LR(1) grammar*. As before, we omit the "(1)" if it is understood-

Example 4.57: The canonical parsing table for grammar (4.55) is shown in Fig. 4.42. Productions 1, 2, and 3 are  $S \wedge CC$ ,  $C \rightarrow cC$ , and  $C \rightarrow d$ , respectively. •

Every SLR(1) grammar is an LR(1) grammar, but for an SLR(1) grammar the canonical LR parser may have more states than the SLR parser for the same grammar. The grammar of the previous examples is SLR and has an SLR parser with seven states, compared with the ten of Fig. 4.42.



STATE	ACTION			GOTO	
	c	d	\$	S	C
0	s3	s4		1	2
1			acc		
2	s6	s7			5
3	s3	s4			8
4	r3	r3			
5			r1		
6	s6	s7			9
7			r3		
8	r2	r2			
9			r2		

Figure 4.42: Canonical parsing table for grammar (4.55)

#### 4.7.4 Constructing LALR Parsing Tables

We now introduce our last parser construction method, the LALR (*lookahead-LR*) technique. This method is often used in practice, because the tables obtained by it are considerably smaller than the canonical LR tables, yet most common syntactic constructs of programming languages can be expressed conveniently by an LALR grammar. The same is almost true for SLR grammars, but there are a few constructs that cannot be conveniently handled by SLR techniques (see Example 4.48, for example).

For a comparison of parser size, the SLR and LALR tables for a grammar always have the same number of states, and this number is typically several hundred states for a language like C. The canonical LR table would typically have several thousand states for the same-size language. Thus, it is much easier and more economical to construct SLR and LALR tables than the canonical LR tables.

By way of introduction, let us again consider grammar (4.55), whose sets of LR(1) items were shown in Fig. 4.41. Take a pair of similar looking states, such as **I4** and **I7**. Each of these states has only items with first component  $C \rightarrow d$ . In **I4**, the lookaheads are c or d; in **I7**, \$ is the only lookahead.

To see the difference between the roles of **I4** and **I7** in the parser, note that the grammar generates the regular language  $c^*dc^*d$ . When reading an input  $cc \dots c d c c \dots - cd$ , the parser shifts the first group of c's and their following d onto the stack, entering state 4 after reading the d. The parser then calls for a reduction by  $C \rightarrow d$ , provided the next input symbol is c or d. The requirement that c or d follow makes sense, since these are the symbols that could begin strings in  $c^*d$ . If \$ follows the first d, we have an input like ccd, which is not in the language, and state 4 correctly declares an error if \$ is the next input.

The parser enters state 7 after reading the second d. Then, the parser must

see \$ on the input, or it started with a string not of the form  $c^*dc^*d$ . It thus makes sense that state 7 should reduce by  $C \rightarrow d$  on input \$ and declare error on inputs  $c$  or  $d$ .

Let us now replace  $I4$  and  $Ij$  by  $J47$ , the union of  $I4$  and  $Ij$ , consisting of the set of three items represented by  $[C \rightarrow \bullet d-, c/d\%]$ . The goto's on  $d$  to  $I4$  or  $Ij$  from  $J_{47}$ ,  $h$ ,  $h$ , and  $i6$  now enter  $J_{47}$ . The action of state 47 is to reduce on any input. The revised parser behaves essentially like the original, although it might reduce  $d$  to  $C$  in circumstances where the original would declare error, for example, on input like  $ccd$  or  $cdcdc$ . The error will eventually be caught; in fact, it will be caught before any more input symbols are shifted.

More generally, we can look for sets of LR(1) items having the same core, that is, set of first components, and we may merge these sets with common cores into one set of items. For example, in Fig. 4.41,  $I4$  and  $Ij$  form such a pair, with core  $\{C \rightarrow \bullet d-\}$ . Similarly,  $J3$  and  $IQ$  form another pair, with core  $\{C \rightarrow \bullet c-C, C \rightarrow -cC, C \rightarrow -d\}$ . There is one more pair,  $J_7$  and  $IQ$ , with common core  $\{C \rightarrow \bullet cC-\}$ . Note that, in general, a core is a set of LR(0) items for the grammar at hand, and that an LR(1) grammar may produce more than two sets of items with the same core.

Since the core of  $GOTO(I,X)$  depends only on the core of  $I$ , the goto's of merged sets can themselves be merged. Thus, there is no problem revising the goto function as we merge sets of items. The action functions are modified to reflect the non-error actions of all sets of items in the merger.

Suppose we have an LR(1) grammar, that is, one whose sets of LR(1) items produce no parsing-action conflicts. If we replace all states having the same core with their union, it is possible that the resulting union will have a conflict, but it is unlikely for the following reason: Suppose in the union there is a conflict on lookahead  $a$  because there is an item  $[A \rightarrow \bullet a-, a]$  calling for a reduction by  $A \rightarrow a$ , and there is another item  $[B \rightarrow \bullet \theta-aj, b]$  calling for a shift. Then some set of items from which the union was formed has item  $[A \rightarrow \bullet a-, a]$ , and since the cores of all these states are the same, it must have an item  $[B \rightarrow \bullet \beta-aj, c]$  for some  $c$ . But then this state has the same shift/reduce conflict on  $a$ , and the grammar was not LR(1) as we assumed. Thus, the merging of states with common cores can never produce a shift/reduce conflict that was not present in one of the original states, because shift actions depend only on the core, not the lookahead.

It is possible, however, that a merger will produce a reduce/reduce conflict, as the following example shows.

Example 4.58: Consider the grammar

$$\begin{array}{ll} S' & S \\ S & aAd \mid bBd \mid aBe \mid bAe \\ A & c \\ B & \rightarrow c \end{array}$$

which generates the four strings  $acd$ ,  $ace$ ,  $bed$ , and  $bee$ . The reader can check that the grammar is LR(1) by constructing the sets of items. Upon doing so,

we find the set of items  $\{[A-tc-, d], [B \quad c-, e]\}$  valid for viable prefix  $ac$  and  $\{[A-+c-,e], [B \rightarrow c-, d]\}$  valid for  $6c$ . Neither of these sets has a conflict, and their cores are the same. However, their union, which is

$$\begin{array}{l} A \rightarrow c-, d/e \\ B \rightarrow c-, d/e \end{array}$$

generates a reduce/reduce conflict, since reductions by both  $A \rightarrow c$  and  $B \rightarrow c$  are called for on inputs  $d$  and  $e$ . •

We are now prepared to give the first of two LALR table-construction algorithms. The general idea is to construct the sets of LR(1) items, and if no conflicts arise, merge sets with common cores. We then construct the parsing table from the collection of merged sets of items. The method we are about to describe serves primarily as a definition of LALR(1) grammars. Constructing the entire collection of LR(1) sets of items requires too much space and time to be useful in practice.

Algorithm 4.59: An easy, but space-consuming LALR table construction.

**INPUT:** An augmented grammar  $G'$ .

**OUTPUT:** The LALR parsing-table functions ACTION and GOTO for  $G'$ .

**METHOD:**

1. Construct  $C = \{I_0, h, \dots, J_n\}$ , the collection of sets of LR(1) items.
2. For each core present among the set of LR(1) items, find all sets having that core, and replace these sets by their union.
3. Let  $C = \{J_0, J_1, \dots, J_n\}$  be the resulting sets of LR(1) items. The parsing actions for state  $i$  are constructed from  $J_i$  in the same manner as in Algorithm 4.56. If there is a parsing action conflict, the algorithm fails to produce a parser, and the grammar is said not to be LALR(1).
4. The GOTO table is constructed as follows. If  $J$  is the union of one or more sets of LR(1) items, that is,  $J = h \cup h \cup \dots \cup h$ , then the cores of  $\text{GOTO}(J_i, X)$ ,  $\text{GOTO}(J_2, X), \dots, \text{GOTO}(J_n, X)$  are the same, since  $J_1, J_2, \dots, J_n$  all have the same core. Let  $K$  be the union of all sets of items having the same core as  $\text{GOTO}(J_i, X)$ . Then  $\text{GOTO}(J, X) = K$ .

**a**

The table produced by Algorithm 4.59 is called the *LALR parsing table* for  $G$ . If there are no parsing action conflicts, then the given grammar is said to be an *LALR(1) grammar*. The collection of sets of items constructed in step (3) is called the *LALR(1) collection*.

Example 4.60: Again consider grammar (4.55) whose **GOTO** graph was shown in Fig. 4.41. As we mentioned, there are three pairs of sets of items that can be merged. **I3** and **IQ** are replaced by their union:

$$\begin{aligned} 7_{3,}: & \quad C \wedge c-C, \quad c/d/\% \\ & \quad C \rightarrow -cC, \quad c/d/\% \\ & \quad C \quad -d, \quad c/d/\% \end{aligned}$$

$h$  and **I7** are replaced by their union:

$$J_{17}: \quad C \rightarrow d-, \quad c/d/\%$$

and  $I_s$  and **IQ** are replaced by their union:

$$I_{s,9}: \quad C \quad cC-, \quad c/d/\%$$

The LALR action and goto functions for the condensed sets of items are shown in Fig. 4.43.

STATE	ACTION			GOTO	
	c	d	\$	S	c
0	s36	s47		1	2
1			acc		
2	s36	s47			5
36	s36	s47			89
47	r3	r3	r3		
5			r1		
89	r2	r2	r2		

Figure 4.43: LALR parsing table for the grammar of Example 4.54

To see how the **GOTO**'s are computed, consider **GOTO**( $7_{3,}, C$ ). In the original set of LR(1) items, **GOTO**( $7_{3,}, C$ ) =  $h$ , and  $I_s$  is now part of **789**, so we make **GOTO**( $J_{36}, C$ ) be **789**. We could have arrived at the same conclusion if we considered **76**, the other part of  $7_{3,}g$ . That is, **GOTO**(**76**,  $C$ ) =  $7g$ , and **IQ** is now part of **7g9**. For another example, consider **GOTO**( $7_2, c$ ), an entry that is exercised after the shift action of  $I_1$  on input  $c$ . In the original sets of LR(1) items, **GOTO**( $7_2, c$ ) = **76**. Since **76** is now part of **736**, **GOTO**( $7_2, c$ ) becomes **736**. Thus, the entry in Fig. 4.43 for state 2 and input  $c$  is made s36, meaning shift and push state 36 onto the stack. •

When presented with a string from the language  $c^*dc^*d$ , both the LR parser of Fig. 4.42 and the LALR parser of Fig. 4.43 make exactly the same sequence of shifts and reductions, although the names of the states on the stack may differ. For instance, if the LR parser puts  $7_1$  or **76** on the stack, the LALR

parser will put  $I_{sc}$  on the stack. This relationship holds in general for an LALR grammar. The LR and LALR parsers will mimic one another on correct inputs.

When presented with erroneous input, the LALR parser may proceed to do some reductions after the LR parser has declared an error. However, the LALR parser will never shift another symbol after the LR parser declares an error. For example, on input *ccd* followed by \$, the LR parser of Fig. 4.42 will put

0 3 3 4

on the stack, and in state 4 will discover an error, because \$ is the next input symbol and state 4 has action error on \$. In contrast, the LALR parser of Fig. 4.43 will make the corresponding moves, putting

0 36 36 47

on the stack. But state 47 on input \$ has action reduce  $C \rightarrow d$ . The LALR parser will thus change its stack to

0 36 36 89

Now the action of state 89 on input \$ is reduce  $C \rightarrow cC$ . The stack becomes

0 36 89

whereupon a similar reduction is called for, obtaining stack

0 2

Finally, state 2 has action error on input \$, so the error is now discovered.

### 4.7.5 Efficient Construction of LALR Parsing Tables

There are several modifications we can make to Algorithm 4.59 to avoid constructing the full collection of sets of LR(1) items in the process of creating an LALR(1) parsing table.

- First, we can represent any set of LR(0) or LR(1) items  $I$  by its kernel, that is, by those items that are either the initial item —  $[S' \quad -S]$  or  $[S' \rightarrow \cdot -S, \$]$  — or that have the dot somewhere other than at the beginning of the production body.
- We can construct the LALR(1)-item kernels from the LR(0)-item kernels by a process of propagation and spontaneous generation of lookaheads, that we shall describe shortly.
- If we have the LALR(1) kernels, we can generate the LALR(1) parsing table by closing each kernel, using the function CLOSURE of Fig. 4.40, and then computing table entries by Algorithm 4.56, as if the LALR(1) sets of items were canonical LR(1) sets of items.

Example 4.61: We shall use as an example of the efficient LALR(1) table-construction method the non-SLR grammar from Example 4.48, which we reproduce below in its augmented form:

$$\begin{array}{lcl} S' & \rightarrow & S \\ S & \rightarrow & L = R \mid R \\ L & \rightarrow & *R \mid \text{id} \\ R & \rightarrow & L \end{array}$$

The complete sets of LR(0) items for this grammar were shown in Fig. 4.39. The kernels of these items are shown in Fig. 4.44. •

$$\begin{array}{ll} \text{io: } S' \rightarrow S & h: L \rightarrow \bullet \text{id} \\ ii: S' \rightarrow S & h: S \wedge L = R \\ h: S \wedge L = R & h: L \rightarrow \bullet *R \\ R \rightarrow L & \\ h: S \rightarrow R & h: R \wedge L \\ h: L \rightarrow *R & h: S \rightarrow L = R \end{array}$$

Figure 4.44: Kernels of the sets of LR(0) items for grammar (4.49)

Now we must attach the proper lookaheads to the LR(0) items in the kernels, to create the kernels of the sets of LALR(1) items. There are two ways a lookahead  $b$  can get attached to an LR(0) item  $B \rightarrow \bullet j-8$  in some set of LALR(1) items  $J$ :

1. There is a set of items  $7$ , with a kernel item  $A \rightarrow a-3, a$ , and  $J = \mathbf{GOTO}(7, X)$ , and the construction of

$$\mathbf{GOTO}(\mathbf{cLOSURE}(\{[A \rightarrow a-3, a]\}), X)$$

as given in Fig. 4.40, contains  $[B \rightarrow 7-5, 6]$ , regardless of  $a$ . Such a lookahead  $b$  is said to be generated *spontaneously* for  $B \rightarrow \wedge-8$ .

2. As a special case, lookahead  $\$$  is generated spontaneously for the item  $S' \rightarrow -S$  in the initial set of items.
3. All is as in (1), but  $a = 6$ , and  $\mathbf{GOTO}(\mathbf{cLOSURE}(\{[\wedge \bullet]\}), X)$ , as given in Fig. 4.40, contains  $[73 \rightarrow 7-6, b]$  only because  $A \rightarrow \wedge-3$  has  $b$  as one of its associated lookaheads. In such a case, we say that lookaheads *propagate* from  $A \rightarrow a-3$  in the kernel of  $7$  to  $73 \rightarrow j-8$  in the kernel of  $J$ . Note that propagation does not depend on the particular lookahead symbol; either all lookaheads propagate from one item to another, or none do.

We need to determine the spontaneously generated lookaheads for each set of LR(0) items, and also to determine which items propagate lookaheads from which. The test is actually quite simple. Let # be a symbol not in the grammar at hand. Let  $A \rightarrow a\beta$  be a kernel LR(0) item in set  $I$ . Compute, for each  $X$ ,  $J = \text{GOTO}(\text{CLOSURE}(\{[A \rightarrow a\beta, \#]\}), X)$ . For each kernel item in  $J$ , we examine its set of lookaheads. If # is a lookahead, then lookaheads propagate to that item from  $A \rightarrow a\beta$ . Any other lookahead is spontaneously generated. These ideas are made precise in the following algorithm, which also makes use of the fact that the only kernel items in  $J$  must have  $X$  immediately to the left of the dot; that is, they must be of the form  $B \rightarrow jX\delta$ .

Algorithm 4.62: Determining lookaheads.

**INPUT:** The kernel  $K$  of a set of LR(0) items / and a grammar symbol  $X$ .

**OUTPUT:** The lookaheads spontaneously generated by items in  $I$  for kernel items in  $\text{GOTO}(I, X)$  and the items in  $I$  from which lookaheads are propagated to kernel items in  $\text{GOTO}(I, X)$ .

**METHOD:** The algorithm is given in Fig. 4.45. •

```

for ( each item  $A \rightarrow a\beta$  in  $K$  ) {
   $J := \text{CLOSURE}(\{[A \rightarrow a\beta, \#]\})$ ;
  if (  $[B \rightarrow jX\delta, a]$  is in  $J$ , and  $a$  is not # )
    conclude that lookahead  $a$  is generated spontaneously for item
       $B \rightarrow jX\delta$  in  $\text{GOTO}(I, X)$ ;
  if (  $[B \rightarrow jX\delta, \#]$  is in  $J$  )
    conclude that lookaheads propagate from  $A \rightarrow a\beta$  in  $I$  to
       $B \rightarrow jX\delta$  in  $\text{GOTO}(I, X)$ ;
}

```

Figure 4.45: Discovering propagated and spontaneous lookaheads

We are now ready to attach lookaheads to the kernels of the sets of LR(0) items to form the sets of LALR(1) items. First, we know that \$ is a lookahead for  $S' \rightarrow S$  in the initial set of LR(0) items. Algorithm 4.62 gives us all the lookaheads generated spontaneously. After listing all those lookaheads, we must allow them to propagate until no further propagation is possible. There are many different approaches, all of which in some sense keep track of "new" lookaheads that have propagated into an item but which have not yet propagated out. The next algorithm describes one technique to propagate lookaheads to all items.

Algorithm 4.63: Efficient computation of the kernels of the LALR(1) collection of sets of items.

**INPUT:** An augmented grammar  $G'$ .

**OUTPUT:** The kernels of the LALR(1) collection of sets of items for  $G'$ .

**METHOD:**

1. Construct the kernels of the sets of LR(0) items for  $G$ . If space is not at a premium, the simplest way is to construct the LR(0) sets of items, as in Section 4.6.2, and then remove the nonkernel items. If space is severely constrained, we may wish instead to store only the kernel items for each set, and compute GOTO for a set of items  $I$  by first computing the closure of  $I$ .
2. Apply Algorithm 4.62 to the kernel of each set of LR(0) items and grammar symbol  $X$  to determine which lookaheads are spontaneously generated for kernel items in  $\text{GOTO}(I, X)$ , and from which items in  $I$  lookaheads are propagated to kernel items in  $\text{GOTO}(I, X)$ .
3. Initialize a table that gives, for each kernel item in each set of items, the associated lookaheads. Initially, each item has associated with it only those lookaheads that we determined in step (2) were generated spontaneously.
4. Make repeated passes over the kernel items in all sets. When we visit an item  $i$ , we look up the kernel items to which  $i$  propagates its lookaheads, using information tabulated in step (2). The current set of lookaheads for  $i$  is added to those already associated with each of the items to which  $i$  propagates its lookaheads. We continue making passes over the kernel items until no more new lookaheads are propagated.

•

Example 4.64: Let us construct the kernels of the LALR(1) items for the grammar of Example 4.61. The kernels of the LR(0) items were shown in Fig. 4.44. When we apply Algorithm 4.62 to the kernel of set of items  $I_0$ , we first compute  $\text{CLOSURE}(\{[S' \rightarrow -S, \#]\})$ , which is

$$\begin{array}{ll} S' \wedge -S, \# & L \rightarrow \bullet \cdot \text{£}, \cdot \# / = \\ S \rightarrow -L = R, \# & L \rightarrow \text{-id}, \# / = \\ S \wedge -R, \# & R \rightarrow -L, \# \end{array}$$

Among the items in the closure, we see two where the lookahead = has been generated spontaneously. The first of these is  $L \rightarrow \bullet \cdot *R$ . This item, with \* to the right of the dot, gives rise to  $[L \rightarrow \bullet * \#, =] \bullet$ . That is, = is a spontaneously generated lookahead for  $L \rightarrow *R$ , which is in set of items  $J_1$ . Similarly,  $[L \rightarrow \bullet \text{id}, =]$  tells us that = is a spontaneously generated lookahead for  $L \rightarrow \text{id} \cdot$  in  $J_2$ .

As # is a lookahead for all six items in the closure, we determine that the item  $S' \rightarrow -S$  in  $J_0$  propagates lookaheads to the following six items:



$$\begin{array}{ll}
 S' \rightarrow S \text{ in } i_1 & L \rightarrow \quad \text{in } i_4 \\
 \mathbf{\$} \rightarrow \bullet L = R \text{ in } i_2 & L \quad \mathbf{id} \text{ in } i_3 \\
 5 \rightarrow i2 \text{ in } i_5 & R \rightarrow L \text{ in } i_6
 \end{array}$$

FROM	TO
$i_0: S'' \quad -5$	$i_1: S' \text{ } \wedge S \text{ -}$ $i_2: S \text{ } + L \text{ -} = R$ $i_3: R \text{ } + L \text{ -}$ $i_4: S \text{ } \rightarrow i2 \text{ -}$ $i_4: \mathbf{X} \rightarrow \mathbf{\$}$ $i_5: L \text{ } + \mathbf{id} \text{ -}$
$i_2: S \wedge L \text{ -} = R$	$i_6: S \wedge L = \text{-}R$
$i_4: L \text{ } * \text{ } *R$	$i_4: L \text{ } \rightarrow *i?$ $i_5: L \text{ } \rightarrow \mathbf{id} \text{ -}$ $i_6: L \quad *E \text{ -}$ $i_6: i? \text{ } + L \text{ -}$
$i_6: S + L = \text{-}R$	$i_4: L \text{ } \rightarrow *i?$ $i_5: \mathbf{\$} \text{ } \rightarrow \mathbf{id} \text{ -}$ $i_8:$ $i_9: S \text{ } \rightarrow L = R \text{ -}$

Figure 4.46: Propagation of lookaheads

In Fig. 4.47, we show steps (3) and (4) of Algorithm 4.63. The column labeled **INIT** shows the spontaneously generated lookaheads for each kernel item. These are only the two occurrences of  $=$  discussed earlier, and the spontaneous lookahead  $\$$  for the initial item  $S' \rightarrow S$ .

On the first pass, the lookahead  $\$$  propagates from  $S' \rightarrow S$  in  $IQ$  to the six items listed in Fig. 4.46. The lookahead  $=$  propagates from  $L \rightarrow *R$  in  $i_4$  to items  $L \rightarrow *R$  in  $I?$  and  $R \rightarrow L$  in  $Is$ . It also propagates to itself and to  $L \rightarrow \mathbf{id}$  in  $I5$ , but these lookaheads are already present. In the second and third passes, the only new lookahead propagated is  $\$$ , discovered for the successors of  $i_2$  and  $i_4$  on pass 2 and for the successor of  $IQ$  on pass 3. No new lookaheads are propagated on pass 4, so the final set of lookaheads is shown in the rightmost column of Fig. 4.47.

Note that the shift/reduce conflict found in Example 4.48 using the SLR method has disappeared with the LALR technique. The reason is that only lookahead  $\$$  is associated with  $R \rightarrow L$  in  $i_6$ , so there is no conflict with the parsing action of shift on  $=$  generated by item  $5 \rightarrow L=R$  in  $i_9$ .

SET	ITEM	LOOKAHEADS			
		INIT	PASS 1	PASS 2	PASS 3
<b>Jo:</b>	$S' \quad -5$	\$	\$	\$	\$
<b>h:</b>			\$	\$	\$
<b>h:</b>	$S \wedge L \quad - =$		\$	\$	\$
	$R \wedge L$		\$	\$	\$
<b>is:</b>	$S \wedge R$		\$	\$	\$
<b>J<sub>1</sub>:</b>	$L \quad - \gg$	=	=\$	=\$	<b>=1%</b>
<b>I<sub>1</sub>:</b>	$L \cdot M d$	=	=\$	=\$	
<b>h:</b>	$S \quad - + L \quad =$			\$	\$
<b>h:</b>	$L$		=	=\$	=\$
<b>IS:</b>	$R \wedge L$		=	=\$	=\$
<b>h:</b>					\$

Figure 4.47: Computation of lookaheads

### 4.7.6 Compaction of LR Parsing Tables

A typical programming language grammar with 50 to 100 terminals and 100 productions may have an LALR parsing table with several hundred states. The action function may easily have 20,000 entries, each requiring at least 8 bits to encode. On small devices, a more efficient encoding than a two-dimensional array may be important. We shall mention briefly a few techniques that have been used to compress the ACTION and GOTO fields of an LR parsing table.

One useful technique for compacting the action field is to recognize that usually many rows of the action table are identical. For example, in Fig. 4.42, states 0 and 3 have identical action entries, and so do 2 and 6. We can therefore save considerable space, at little cost in time, if we create a pointer for each state into a one-dimensional array. Pointers for states with the same actions point to the same location. To access information from this array, we assign each terminal a number from zero to one less than the number of terminals, and we use this integer as an offset from the pointer value for each state. In a given state, the parsing action for the  $i$ th terminal will be found  $i$  locations past the pointer value for that state.

Further space efficiency can be achieved at the expense of a somewhat slower parser by creating a list for the actions of each state. The list consists of (terminal-symbol, action) pairs. The most frequent action for a state can be

placed at the end of the list, and in place of a terminal we may use the notation "any," meaning that if the current input symbol has not been found so far on the list, we should do that action no matter what the input is. Moreover, error entries can safely be replaced by reduce actions, for further uniformity along a row. The errors will be detected later, before a shift move.

**Example 4.65:** Consider the parsing table of Fig. 4.37. First, note that the actions for states 0, 4, 6, and 7 agree. We can represent them all by the list

SYMBOL	ACTION
<b>id</b>	s5
(	s4
<b>any</b>	error

State 1 has a similar list:

+	s6
	acc
<b>any</b>	error

In state 2, we can replace the error entries by r2, so reduction by production 2 will occur on any input but \*. Thus the list for state 2 is

	s7
<b>any</b>	r2

State 3 has only error and r4 entries. We can replace the former by the latter, so the list for state 3 consists of only the pair (**any**, r4). States 5, 10, and 11 can be treated similarly. The list for state 8 is

+	s6
	<b>s11</b>
<b>any</b>	error

and for state 9

	s7
	<b>s11</b>
<b>any</b>	<b>r1</b>

•

We can also encode the **GOTO** table by a list, but here it appears more efficient to make a list of pairs for each nonterminal  $A$ . Each pair on the list for  $A$  is of the form  $(currentState, nextState)$ , indicating

$$\mathbf{GOTO} [currentState, A] = next\ State$$

This technique is useful because there tend to be rather few states in any one column of the GOTO table. The reason is that the GOTO on nonterminal  $A$  can only be a state derivable from a set of items in which some items have  $A$  immediately to the left of a dot. No set has items with  $X$  and  $Y$  immediately to the left of a dot if  $X \wedge Y$ . Thus, each state appears in at most one GOTO column.

For more space reduction, we note that the error entries in the goto table are never consulted. We can therefore replace each error entry by the most common non-error entry in its column. This entry becomes the default; it is represented in the list for each column by one pair with **any** in place of *currentState*.

**Example 4.66:** Consider Fig. 4.37 again. The column for  $F$  has entry 10 for state 7, and all other entries are either 3 or error. We may replace error by 3 and create for column  $F$  the list

CURRENTSTATE	NEXTSTATE
7	10
<b>any</b>	3

Similarly, a suitable list for column  $T$  is

6	9
<b>any</b>	2

For column  $E$  we may choose either 1 or 8 to be the default; two entries are necessary in either case. For example, we might create for column  $E$  the list

4	8
<b>any</b>	1

•

This space savings in these small examples may be misleading, because the total number of entries in the lists created in this example and the previous one together with the pointers from states to action lists and from nonterminals to next-state lists, result in unimpressive space savings over the matrix implementation of Fig. 4.37. For practical grammars, the space needed for the list representation is typically less than ten percent of that needed for the matrix representation. The table-compression methods for finite automata that were discussed in Section 3.9.8 can also be used to represent LR parsing tables.

### 4.7.7 Exercises for Section 4.7

**Exercise 4.7.1:** Construct the

- a) canonical LR, and
- b) LALR

sets of items for the grammar  $S \rightarrow SS \mid + \mid \backslash SS^* \mid aof$  Exercise 4.2.1.

**Exercise 4.7.2:** Repeat Exercise 4.7.1 for each of the (augmented) grammars of Exercise 4.2.2(a)-(g).

**! Exercise 4.7.3:** For the grammar of Exercise 4.7.1, use Algorithm 4.63 to compute the collection of LALR sets of items from the kernels of the LR(0) sets of items.

**! Exercise 4.7.4:** Show that the following grammar

$$\begin{array}{l} S \rightarrow A a \mid b A c \mid d c \mid b d a \\ A \rightarrow d \end{array}$$

is LALR(1) but not SLR(1).

**! Exercise 4.7.5:** Show that the following grammar

$$\begin{array}{l} S \rightarrow A a \mid b A c \mid B c \mid b B a \\ A \rightarrow + \mid d \\ B \rightarrow d \end{array}$$

is LR(1) but not LALR(1).

## 4.8 Using Ambiguous Grammars

It is a fact that every ambiguous grammar fails to be LR and thus is not in any of the classes of grammars discussed in the previous two sections. However, certain types of ambiguous grammars are quite useful in the specification and implementation of languages. For language constructs like expressions, an ambiguous grammar provides a shorter, more natural specification than any equivalent unambiguous grammar. Another use of ambiguous grammars is in isolating commonly occurring syntactic constructs for special-case optimization. With an ambiguous grammar, we can specify the special-case constructs by carefully adding new productions to the grammar.

Although the grammars we use are ambiguous, in all cases we specify disambiguating rules that allow only one parse tree for each sentence. In this way, the overall language specification becomes unambiguous, and sometimes it becomes possible to design an LR parser that follows the same ambiguity-resolving choices. We stress that ambiguous constructs should be used sparingly and in a strictly controlled fashion; otherwise, there can be no guarantee as to what language is recognized by a parser.

### 4.8.1 Precedence and Associativity to Resolve Conflicts

Consider the ambiguous grammar (4.3) for expressions with operators + and \*, repeated here for convenience:

$$E \rightarrow E + E \mid E * E \mid (E) \quad \mathbf{I} \quad \mathbf{id}$$

This grammar is ambiguous because it does not specify the associativity or precedence of the operators + and \*. The unambiguous grammar (4.1), which includes productions  $E \rightarrow E + T$  and  $T \rightarrow T * F$ , generates the same language, but gives + lower precedence than \*, and makes both operators left associative. There are two reasons why we might prefer to use the ambiguous grammar. First, as we shall see, we can easily change the associativity and precedence of the operators + and \* without disturbing the productions of (4.3) or the number of states in the resulting parser. Second, the parser for the unambiguous grammar will spend a substantial fraction of its time reducing by the productions  $E \rightarrow T$  and  $T \rightarrow F$ , whose sole function is to enforce associativity and precedence. The parser for the ambiguous grammar (4.3) will not waste time reducing by these *single* productions (productions whose body consists of a single nonterminal).

The sets of LR(0) items for the ambiguous expression grammar (4.3) augmented by  $E' \rightarrow E$  are shown in Fig. 4.48. Since grammar (4.3) is ambiguous, there will be parsing-action conflicts when we try to produce an LR parsing table from the sets of items. The states corresponding to sets of items  $I_j$  and  $I_s$  generate these conflicts. Suppose we use the SLR approach to constructing the parsing action table. The conflict generated by  $I_7$  between reduction by  $E \rightarrow E + E$  and shift on + or \* cannot be resolved, because + and \* are each in FOLLOW( $\epsilon'$ ). Thus both actions would be called for on inputs + and \*. A similar conflict is generated by  $I_s$ , between reduction by  $E \rightarrow E * E$  and shift on inputs + and \*. In fact, each of our LR parsing table-construction methods will generate these conflicts.

However, these problems can be resolved using the precedence and associativity information for + and \*. Consider the input **id + id \* id**, which causes a parser based on Fig. 4.48 to enter state 7 after processing **id + id**; in particular the parser reaches a configuration

PREFIX	STACK	INPUT
$E + E$	0 1 4 7	<b>*id\$</b>

For convenience, the symbols corresponding to the states 1, 4, and 7 are also shown under PREFIX.

If \* takes precedence over +, we know the parser should shift \* onto the stack, preparing to reduce the \* and its surrounding id symbols to an expression. This choice was made by the SLR parser of Fig. 4.37, based on an unambiguous grammar for the same language. On the other hand, if + takes precedence over \*, we know the parser should reduce  $E + E$  to  $E$ . Thus the relative precedence

<p><b>io:</b> <math>E' \quad \epsilon_7</math>  <math>E \rightarrow -E + E</math>  <math>E \wedge E * E</math>  <math>E \rightarrow -(E)</math>  <math>E \rightarrow \mathbf{id}</math></p>	<p><math>\epsilon_7 \rightarrow \epsilon_7 * \epsilon_7</math>  <math>\epsilon_7 \rightarrow \epsilon_7 + \epsilon_7</math>  <math>E \rightarrow -E * E</math>  <math>E \rightarrow -(E)</math>  <math>E \quad \mathbf{id}</math></p>
<p><b>h:</b> <math>\epsilon_7' \rightarrow \epsilon_7</math>  <math>\epsilon_7 \rightarrow \epsilon_7 + E</math>  <math>E \rightarrow E * E</math></p>	<p><b>h:</b> <math>\epsilon_7 \rightarrow (\epsilon_7)</math>  <math>\epsilon_7 \rightarrow \epsilon_7 + \epsilon_7</math>  <math>\epsilon_7 \rightarrow \epsilon_7 * \epsilon_7</math></p>
<p><b>h:</b> <math>E \rightarrow (\epsilon_7)</math>  <math>E \wedge -E + E</math>  <math>E \rightarrow -\epsilon_7 * \epsilon_7</math>  <math>E \rightarrow +iE)</math>  <math>E \quad \mathbf{id}</math></p>	<p><b>lr:</b> <math>\epsilon_7 \rightarrow \epsilon_7 + \epsilon_7</math>  <math>\epsilon_7 \rightarrow \epsilon_7 + \epsilon_7</math>  <math>\epsilon_7 \rightarrow \epsilon_7 * \epsilon_7</math>  <math>E \rightarrow +E * E</math>  <math>E \rightarrow \epsilon_7 + \epsilon_7</math>  <math>\epsilon_7 \rightarrow \epsilon_7 * \epsilon_7</math></p>
<p><b>h:</b> <math>\epsilon_7 \rightarrow \mathbf{id}</math></p>	<p><math>\epsilon_7 \rightarrow \epsilon_7 * \epsilon_7</math></p>
<p><b>h:</b> <math>\epsilon_7 \rightarrow E + \epsilon_7</math>  <math>\epsilon_7 \rightarrow -\epsilon_7 + \epsilon_7</math>  <math>\epsilon_7 \rightarrow -\epsilon_7 * \epsilon_7</math>  <math>E \rightarrow -(E)</math>  <math>\epsilon_7 \rightarrow \mathbf{id}</math></p>	<p><math>\epsilon_7 \rightarrow (\epsilon_7)</math></p>

Figure 4.48: Sets of LR(0) items for an augmented expression grammar

of  $+$  followed by  $*$  uniquely determines how the parsing action conflict between reducing  $\epsilon_7 \rightarrow \epsilon_7 + \epsilon_7$  and shifting on  $*$  in state 7 should be resolved.

If the input had been  $\mathbf{id} + \mathbf{id} + \mathbf{id}$  instead, the parser would still reach a configuration in which it had stack 0 14 7 after processing input  $\mathbf{id} + \mathbf{id}$ . On input  $+$  there is again a shift/reduce conflict in state 7. Now, however, the associativity of the  $+$  operator determines how this conflict should be resolved. If  $+$  is left associative, the correct action is to reduce by  $\epsilon_7 \rightarrow E + E$ . That is, the  $\mathbf{id}$  symbols surrounding the first  $+$  must be grouped first. Again this choice coincides with what the SLR parser for the unambiguous grammar would do.

In summary, assuming  $+$  is left associative, the action of state 7 on input  $+$  should be to reduce by  $\epsilon_7 \rightarrow E + \epsilon_7$ , and assuming that  $*$  takes precedence over  $+$ , the action of state 7 on input  $*$  should be to shift. Similarly, assuming that  $*$  is left associative and takes precedence over  $+$ , we can argue that state 8, which can appear on top of the stack only when  $E * E$  are the top three grammar symbols, should have the action reduce  $\epsilon_7 \rightarrow E * E$  on both  $+$  and  $*$  inputs. In the case of input  $+$ , the reason is that  $*$  takes precedence over  $+$ , while in the case of input  $*$ , the rationale is that  $*$  is left associative.

Proceeding in this way, we obtain the LR parsing table shown in Fig. 4.49. Productions 1 through 4 are  $E \rightarrow E + E$ ,  $E \rightarrow E * E$ ,  $E \rightarrow (E)$ , and  $E \rightarrow \text{id}$ , respectively. It is interesting that a similar parsing action table would be produced by eliminating the reductions by the single productions  $E \rightarrow T$  and  $T \rightarrow F$  from the SLR table for the unambiguous expression grammar (4.1) shown in Fig. 4.37. Ambiguous grammars like the one for expressions can be handled in a similar way in the context of LALR and canonical LR parsing.

STATE	ACTION						GOTO
	id	+	*	(	)	\$	
0	s3			s2			1
1		s4	s5			acc	
2	s3			s2			6
3		r4	r4		r4	r4	
4	s3			s2			7
5	s3			s2			8
6		s4	s5		s9		
7		r1	s5		r1	r1	
8		r2	r2		r2	r2	
9		r3	r3		r3	r3	

Figure 4.49: Parsing table for grammar (4.3)

## 4.8.2 The "Dangling-Else" Ambiguity

Consider again the following grammar for conditional statements:

$$\begin{aligned} \text{stmt} &\rightarrow \text{if expr then stmt else stmt} \\ &| \text{if expr then stmt} \\ &| \text{other} \end{aligned}$$

As we noted in Section 4.3.2, this grammar is ambiguous because it does not resolve the dangling-else ambiguity. To simplify the discussion, let us consider an abstraction of this grammar, where  $i$  stands for **if expr then**,  $e$  stands for **else**, and  $a$  stands for "all other productions." We can then write the grammar, with augmenting production  $S' \rightarrow S$ , as

$$S \rightarrow iSeS \mid iS \mid a \tag{4.67}$$

The sets of LR(0) items for grammar (4.67) are shown in Fig. 4.50. The ambiguity in (4.67) gives rise to a shift/reduce conflict in I4. There,  $S \rightarrow \bullet iSeS$  calls for a shift of  $e$  and, since  $\text{FOLLOW}(5) = \{e, \$\}$ , item  $S \rightarrow \bullet iS$  calls for reduction by  $5 \rightarrow iS$  on input  $e$ .

Translating back to the **if-then-else** terminology, given



$S' \rightarrow ++S$	$h:$	$S \rightarrow a-$
$S \rightarrow -iSeS$		
$S \rightarrow y-iS$	$h:$	$S \rightarrow iS-eS$
$S \rightarrow -a$		
$h:$	$h:$	$S \rightarrow iSe-S$
$S' \rightarrow +S-$		$S \rightarrow -+ -iSeS$
		$S^{\wedge}-iS$
$S \rightarrow + iSeS$		$S \rightarrow \bullet -a$
$S \rightarrow -i i-S$		
$S \rightarrow -iSeS$		$S \rightarrow -t iSeS-$
$S^{\wedge}-iS$		
$S^{\wedge}-a$		

Figure 4.50: LR(0) states for augmented grammar (4.67)

**if** *expr* **then** *stmt*

on the stack and **else** as the first input symbol, should we shift **else** onto the stack (i.e., shift *e*) or reduce **if** *expr* **then** *stmt* (i.e., reduce by  $S \rightarrow iS$ )? The answer is that we should shift **else**, because it is "associated" with the previous **then**. In the terminology of grammar (4.67), the *e* on the input, standing for **else**, can only form part of the body beginning with the *iS* now on the top of the stack. If what follows *e* on the input cannot be parsed as an *S*, completing body *iSeS*, then it can be shown that there is no other parse possible.

We conclude that the shift/reduce conflict in **J4** should be resolved in favor of shift on input *e*. The SLR parsing table constructed from the sets of items of Fig. 4.48, using this resolution of the parsing-action conflict in *I4* on input *e*, is shown in Fig. 4.51. Productions 1 through 3 are  $S \rightarrow iSeS$ ,  $S \rightarrow \bullet iS$ , and  $S \rightarrow \bullet a$ , respectively.

STATE	ACTION				GOTO
	<i>i</i>	<i>e</i>	<i>a</i>	\$	
0	s2		s3		1
1				acc	
2	s2		s3		4
3		r3		r3	
4		s5		r2	
5	s2		s3		6
6		r1		r1	

Figure 4.51: LR parsing table for the "dangling-else" grammar

For example, on input *iaea*, the parser makes the moves shown in Fig. 4.52, corresponding to the correct resolution of the "dangling-else." At line (5), state 4 selects the shift action on input *e*, whereas at line (9), state 4 calls for reduction by  $S \rightarrow iS$  on input \$.

	STACK	SYMBOLS	INPUT	ACTION
(1)	0		<i>iaea</i> \$	shift
(2)	0 2	<i>i</i>	<i>iaea</i> \$	shift
(3)	0 2 2	<i>i i</i>	<i>aea</i> %	shift
(4)	0 2 2 3	<i>ii a</i>	<i>ea</i> %	shift
(5)	0 2 2 4	<b><i>aS</i></b>	<i>ea</i> %	reduce by $S \rightarrow \bullet a$
(6)	0 2 2 4 5	<i>USe</i>	<i>a</i> %	shift
(7)	0 2 2 4 5 3	<i>iiSea</i>	\$	reduce by $S \rightarrow a$
(8)	0 2 2 4 5 6	<i>USeS</i>	\$	reduce by $S \rightarrow \bullet iSeS$
(9)	0 2 4	<i>iS</i>	\$	reduce by $S \rightarrow iS$
(10)	0 1	<i>S</i>	\$	accept

Figure 4.52: Parsing actions on input *iaea*

By way of comparison, if we are unable to use an ambiguous grammar to specify conditional statements, then we would have to use a bulkier grammar along the lines of Example 4.16.

### 4.8.3 Error Recovery in LR Parsing

An LR parser will detect an error when it consults the parsing action table and finds an error entry. Errors are never detected by consulting the goto table. An LR parser will announce an error as soon as there is no valid continuation for the portion of the input thus far scanned. A canonical LR parser will not make even a single reduction before announcing an error. SLR and LALR parsers may make several reductions before announcing an error, but they will never shift an erroneous input symbol onto the stack.

In LR parsing, we can implement panic-mode error recovery as follows. We scan down the stack until a state  $s$  with a goto on a particular nonterminal  $A$  is found. Zero or more input symbols are then discarded until a symbol  $a$  is found that can legitimately follow  $A$ . The parser then stacks the state  $GOTO(s, A)$  and resumes normal parsing. There might be more than one choice for the nonterminal  $A$ . Normally these would be nonterminals representing major program pieces, such as an expression, statement, or block. For example, if  $A$  is the nonterminal *stmt*,  $a$  might be semicolon or  $\}$ , which marks the end of a statement sequence.

This method of recovery attempts to eliminate the phrase containing the syntactic error. The parser determines that a string derivable from  $A$  contains an error. Part of that string has already been processed, and the result of this

processing is a sequence of states on top of the stack. The remainder of the string is still in the input, and the parser attempts to skip over the remainder of this string by looking for a symbol on the input that can legitimately follow  $A$ . By removing states from the stack, skipping over the input, and pushing  $\text{GOTO}(s, A)$  on the stack, the parser pretends that it has found an instance of  $A$  and resumes normal parsing.

Phrase-level recovery is implemented by examining each error entry in the LR parsing table and deciding on the basis of language usage the most likely programmer error that would give rise to that error. An appropriate recovery procedure can then be constructed; presumably the top of the stack and/or first input symbols would be modified in a way deemed appropriate for each error entry.

In designing specific error-handling routines for an LR parser, we can fill in each blank entry in the action field with a pointer to an error routine that will take the appropriate action selected by the compiler designer. The actions may include insertion or deletion of symbols from the stack or the input or both, or alteration and transposition of input symbols. We must make our choices so that the LR parser will not get into an infinite loop. A safe strategy will assure that at least one input symbol will be removed or shifted eventually, or that the stack will eventually shrink if the end of the input has been reached. Popping a stack state that covers a nonterminal should be avoided, because this modification eliminates from the stack a construct that has already been successfully parsed.

Example 4.68: Consider again the expression grammar

$$E \rightarrow E + E \mid E * E \mid (E) \mid \text{id}$$

Figure 4.53 shows the LR parsing table from Fig. 4.49 for this grammar, modified for error detection and recovery. We have changed each state that calls for a particular reduction on some input symbols by replacing error entries in that state by the reduction. This change has the effect of postponing the error detection until one or more reductions are made, but the error will still be caught before any shift move takes place. The remaining blank entries from Fig. 4.49 have been replaced by calls to error routines.

The error routines are as follows.

- e1: This routine is called from states 0, 2, 4 and 5, all of which expect the beginning of an operand, either an id or a left parenthesis. Instead, +, \*, or the end of the input was found.

push state 3 (the goto of states 0, 2, 4 and 5 on id);  
issue diagnostic "missing operand."

- e2: Called from states 0, 1, 2, 4 and 5 on finding a right parenthesis.

remove the right parenthesis from the input;  
issue diagnostic "unbalanced right parenthesis."

STATE	ACTION						GOTO
	id	+	*	(	)	\$	<i>E</i>
0	s3	e1	e1	s2	e2	e1	1
1	e3	s4	s5	e3	e2	acc	
2	s3	e1	e1	s2	e2	e1	6
3	r4	r4	r4	r4	r4	r4	
4	s3	e1	e1	s2	e2	e1	7
5	s3	e1	e1	s2	e2	e1	8
6	e3	s4	s5	e3	s9	e4	
7	r1	r1	s5	r1	r1	r1	
8	r2	r2	r2	r2	r2	r2	
9	r3	r3	r3	r3	r3	r3	

Figure 4.53: LR parsing table with error routines

**e3:** Called from states 1 or 6 when expecting an operator, and an **id** or right parenthesis is found.

push state 4 (corresponding to symbol +) onto the stack;  
issue diagnostic "missing operator."

**e4:** Called from state 6 when the end of the input is found.

push state 9 (for a right parenthesis) onto the stack;  
issue diagnostic "missing right parenthesis."

On the erroneous input **id +**), the sequence of configurations entered by the parser is shown in Fig. 4.54. •

#### 4.8.4 Exercises for Section 4.8

**! Exercise 4.8.1:** The following is an ambiguous grammar for expressions with  $n$  binary, infix operators, at  $n$  different levels of precedence:

$$E \rightarrow E \circ_1 E \mid E \circ_2 E \mid \dots \mid E \circ_n E \mid ( E ) \mid \mathbf{id}$$

- As a function of  $n$ , what are the SLR sets of items?
- How would you resolve the conflicts in the SLR items so that all operators are left associative, and  $\circ_n$  takes precedence over  $\circ_{n-1}$ , which takes precedence over  $\circ_{n-2}$ , and so on?
- Show the SLR parsing table that results from your decisions in part (b).

STACK	SYMBOLS	INPUT	ACTION
0		<b>id + )\$</b>	
0 3	<b>id</b>	+ )\$	
0 1	<i>E</i>	+ )\$	
0 1 4	<i>E +</i>	)\$	"unbalanced right parenthesis" e2 removes right parenthesis
0 1 4	<i>E +</i>	\$	"missing operand" e1 pushes state 3 onto stack
0 14 3	<i>E + id</i>	\$	
0 14 7	<i>E +</i>	\$	
0 1	<i>E +</i>	\$	

Figure 4.54: Parsing and error recovery moves made by an LR parser

- d) Repeat parts (a) and (c) for the unambiguous grammar, which defines the same set of expressions, shown in Fig. 4.55.
- e) How do the counts of the number of sets of items and the sizes of the tables for the two (ambiguous and unambiguous) grammars compare? What does that comparison tell you about the use of ambiguous expression grammars?

$$\begin{array}{l}
 E_1 \quad \quad \quad E_1 \cup E_2 / E_2 \\
 E_2 \quad \quad \quad E_2 \cup E_1 \cup E_3 \\
 \\
 E_n \quad \quad \rightarrow \quad E_n \cup E_n \cup E_{n+i} \\
 E_{n+i} \quad \rightarrow \quad \{E_n\}id
 \end{array}$$

Figure 4.55: Unambiguous grammar for n operators

**! Exercise 4.8.2:** In Fig. 4.56 is a grammar for certain statements, similar to that discussed in Exercise 4.4.12. Again, *e* and *s* are terminals standing for conditional expressions and "other statements," respectively.

- Build an LR parsing table for this grammar, resolving conflicts in the usual way for the dangling-else problem.
- Implement error correction by filling in the blank entries in the parsing table with extra reduce-actions or suitable error-recovery routines.
- Show the behavior of your parser on the following inputs:

- if e then s ; if e then s end**
- while e do begin s ; if e then s ; end**

```

stmt  ->  if e then stmt
          |  if e then stmt else stmt
          |  while e do stmt
          |  begin list end
          |  I s
list  ->  fet ; stmt
          |  stmt

```

Figure 4.56: A grammar for certain kinds of statements

## 4.9 Parser Generators

This section shows how a parser generator can be used to facilitate the construction of the front end of a compiler. We shall use the LALR parser generator **Yacc** as the basis of our discussion, since it implements many of the concepts discussed in the previous two sections and it is widely available. **Yacc** stands for "yet another compiler-compiler," reflecting the popularity of parser generators in the early 1970s when the first version of **Yacc** was created by S. C. Johnson. **Yacc** is available as a command on the UNIX system, and has been used to help implement many production compilers.

### 4.9.1 The Parser Generator Yacc

A translator can be constructed using **Yacc** in the manner illustrated in Fig. 4.57. First, a file, say **translate.y**, containing a **Yacc** specification of the translator is prepared. The UNIX system command

```
yacc translate.y
```

transforms the file **translate.y** into a C program called **y.tab.c** using the LALR method outlined in Algorithm 4.63. The program **y.tab.c** is a representation of an LALR parser written in C, along with other C routines that the user may have prepared. The LALR parsing table is compacted as described in Section 4.7. By compiling **y.tab.c** along with the **ly** library that contains the LR parsing program using the command

```
cc y.tab.c -ly
```

we obtain the desired object program **a.out** that performs the translation specified by the original **Yacc** program.<sup>7</sup> If other procedures are needed, they can be compiled or loaded with **y.tab.c**, just as with any C program.

A **Yacc** source program has three parts:

<sup>7</sup>The name **ly** is system dependent.

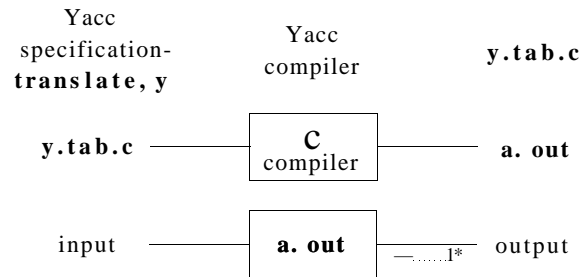
Figure 4.57: Creating an input/output translator with **Yacc**

declarations

***n***

translation rules

***n***

supporting C routines

**Example 4.69:** To illustrate how to prepare a **Yacc** source program, let us construct a simple desk calculator that reads an arithmetic expression, evaluates it, and then prints its numeric value. We shall build the desk calculator starting with the with the following grammar for arithmetic expressions:

$$\begin{aligned}
 E &\rightarrow E + T \mid T \\
 T &\rightarrow T * F \mid F \\
 F &\rightarrow \langle \text{digit} \rangle \mid \langle \text{digit} \rangle^*
 \end{aligned}$$

The token **digit** is a single digit between 0 and 9. A **Yacc** desk calculator program derived from this grammar is shown in Fig. 4.58. •

### The Declarations Part

There are two sections in the declarations part of a **Yacc** program; both are optional. In the first section, we put ordinary C declarations, delimited by `/{` and `/}`. Here we place declarations of any temporaries used by the translation rules or procedures of the second and third sections. In Fig. 4.58, this section contains only the include-statement

```
#include <ctype.h>
```

that causes the C preprocessor to include the standard header file `<ctype.h>` that contains the predicate `isdigit`.

Also in the declarations part are declarations of grammar tokens. In Fig. 4.58, the statement

```
%token DIGIT
```

```

#include <ctype.h>

/.token DIGIT

U
line  : expr '\n'      { printf("%d\n", $1); }

expr  : expr »+ term  { $$ = $1 + $3; }
      | term
      >
term  : term '*> factor { $$ = $1 * $3; >
      | factor
      >
factor: '(' expr »)'  { $$ = $2; }
      | DIGIT
      >

//
yylexQ {
    int c;
    c = getchar();
    if (isdigit(c)) {
        yylval = c-'0';
        return DIGIT;
    }
    return c;
}

```

Figure 4.58: **Yacc** specification of a simple desk calculator

declares `DIGIT` to be a token. Tokens declared in this section can then be used in the second and third parts of the **Yacc** specification. If **Lex** is used to create the lexical analyzer that passes tokens to the **Yacc** parser, then these token declarations are also made available to the analyzer generated by **Lex**, as discussed in Section 3.5.2.

### The Translation Rules Part

In the part of the **Yacc** specification after the first `%%` pair, we put the translation rules. Each rule consists of a grammar production and the associated semantic action. A set of productions that we have been writing:

$$(\text{head})_n \rightarrow (\text{body})! \mid <(\text{body})_2 \mid \dots \mid (\text{body})_n$$

would be written in **Yacc** as



```

(head)  : (body)i { (semantic action)i }
        I (body) 2 { (semantic action) 2 }

        I (body), { (semantic action), }

```

In a **Yacc** production, unquoted strings of letters and digits not declared to be tokens are taken to be nonterminals. A quoted single character, e.g. 'c', is taken to be the terminal symbol **c**, as well as the integer code for the token represented by that character (i.e., **Lex** would return the character code for 'c' to the parser, as an integer). Alternative bodies can be separated by a vertical bar, and a semicolon follows each head with its alternatives and their semantic actions. The first head is taken to be the start symbol.

A **Yacc** semantic action is a sequence of C statements. In a semantic action, the symbol \$\$ refers to the attribute value associated with the nonterminal of the head, while \$i refers to the value associated with the *i*th grammar symbol (terminal or nonterminal) of the body. The semantic action is performed whenever we reduce by the associated production, so normally the semantic action computes a value for \$\$ in terms of the \$i's. In the **Yacc** specification, we have written the two *E*-productions

$$E \rightarrow E + T \quad | \quad T$$

and their associated semantic actions as:

```

expr : expr >+> term    { $$ = $1 + $3; }
      | term

```

Note that the nonterminal **term** in the first production is the third grammar symbol of the body, while + is the second. The semantic action associated with the first production adds the value of the **expr** and the **term** of the body and assigns the result as the value for the nonterminal **expr** of the head. We have omitted the semantic action for the second production altogether, since copying the value is the default action for productions with a single grammar symbol in the body. In general, { \$\$ = \$1; } is the default semantic action.

Notice that we have added a new starting production

```

line : expr >\n'    { printf07.d\n", $1); }

```

to the **Yacc** specification. This production says that an input to the desk calculator is to be an expression followed by a newline character. The semantic action associated with this production prints the decimal value of the expression followed by a newline character.

### The Supporting C-Routines Part

The third part of a **Yacc** specification consists of supporting C-routines. A lexical analyzer by the name `yylexO` must be provided. Using `Lex` to produce `yylexO` is a common choice; see Section 4.9.3. Other procedures such as error recovery routines may be added as necessary.

The lexical analyzer `yylexO` produces tokens consisting of a token name and its associated attribute value. If a token name such as **DIGIT** is returned, the token name must be declared in the first section of the **Yacc** specification. The attribute value associated with a token is communicated to the parser through a **Yacc**-defined variable `yylval`.

The lexical analyzer in Fig. 4.58 is very crude. It reads input characters one at a time using the C-function `getchar()`. If the character is a digit, the value of the digit is stored in the variable `yylval`, and the token name **DIGIT** is returned. Otherwise, the character itself is returned as the token name.

### 4.9.2 Using Yacc with Ambiguous Grammars

Let us now modify the **Yacc** specification so that the resulting desk calculator becomes more useful. First, we shall allow the desk calculator to evaluate a sequence of expressions, one to a line. We shall also allow blank lines between expressions. We do so by changing the first rule to

```
lines : lines expr '\n'      { printf("%g\n", $2); }
      | lines '\n'
      | /* empty */
```

In **Yacc**, an empty alternative, as the third line is, denotes  $\epsilon$ .

Second, we shall enlarge the class of expressions to include numbers instead of single digits and to include the arithmetic operators  $+$ ,  $-$ , (both binary and unary),  $*$ , and  $/$ . The easiest way to specify this class of expressions is to use the ambiguous grammar

$$E \wedge E + E \mid E - E \mid E * E \mid E / E \mid - E \mid \text{number}$$

The resulting **Yacc** specification is shown in Fig. 4.59.

Since the grammar in the **Yacc** specification in Fig. 4.59 is ambiguous, the LALR algorithm will generate parsing-action conflicts. **Yacc** reports the number of parsing-action conflicts that are generated. A description of the sets of items and the parsing-action conflicts can be obtained by invoking **Yacc** with a `-v` option. This option generates an additional file `y.output` that contains the kernels of the sets of items found for the grammar, a description of the parsing action conflicts generated by the LALR algorithm, and a readable representation of the LR parsing table showing how the parsing action conflicts were resolved. Whenever **Yacc** reports that it has found parsing-action conflicts, it

```

%i
#include <ctype.h>
#include <stdio.h>
#define YYSTYPE double /* double type for Yacc stack */
%}
%.token NUMBER
•/.left »+»
%.left '*' '/'
•/.right UMINUS

lines  lines expr '\n'  { printf 07,g\n", $2); }
      lines '\n'
      /* empty */

expr   expr '+' expr      = $1 + $3; }
      expr '-'> expr      = $1 - $3; }
      expr '*' expr       = $1 * $3; }
      expr '/' expr       = $1 / $3; }
      '(' expr ')'        = $2; }
      '-' expr V.prec UMINUS {      $2; }
      NUMBER

yylex0 {
  int c;
  while ( ( c = getchar0 ) == ' ' );
  if ( (c == '.') || (isdigit(c)) ) {
    unget c(c, stdin);
    scanf("/.If", ftyylval);
    return NUMBER;
  }
  return c;
}

```

Figure 4.59: Yacc specification for a more advanced desk calculator.

is wise to create and consult the file `y.output` to see why the parsing-action conflicts were generated and to see whether they were resolved correctly.

Unless otherwise instructed **Yacc** will resolve all parsing action conflicts using the following two rules:

1. A reduce/reduce conflict is resolved by choosing the conflicting production listed first in the **Yacc** specification.
2. A shift/reduce conflict is resolved in favor of shift. This rule resolves the shift /reduce conflict arising from the dangling-else ambiguity correctly.

Since these default rules may not always be what the compiler writer wants, **Yacc** provides a general mechanism for resolving shift/reduce conflicts. In the declarations portion, we can assign precedences and associativities to terminals. The declaration

```
%.left ' + '
```

makes `+` and `-` be of the same precedence and be left associative. We can declare an operator to be right associative by writing

```
%.right
```

and we can force an operator to be a nonassociative binary operator (i.e., two occurrences of the operator cannot be combined at all) by writing

```
%,nonassoc '<'
```

The tokens are given precedences in the order in which they appear in the declarations part, lowest first. Tokens in the same declaration have the same precedence. Thus, the declaration

```
%.right UMINUS
```

in Fig. 4.59 gives the token **UMINUS** a precedence level higher than that of the five preceding terminals.

**Yacc** resolves shift/reduce conflicts by attaching a precedence and associativity to each production involved in a conflict, as well as to each terminal involved in a conflict. If it must choose between shifting input symbol  $a$  and reducing by production  $A \rightarrow a$ , **Yacc** reduces if the precedence of the production is greater than that of  $a$ , or if the precedences are the same and the associativity of the production is **left**. Otherwise, shift is the chosen action.

Normally, the precedence of a production is taken to be the same as that of its rightmost terminal. This is the sensible decision in most cases. For example, given productions

$$E \rightarrow \bullet E + E \quad / \quad E + E \bullet$$

we would prefer to reduce by  $E \rightarrow E + E$  with lookahead  $+$ , because the  $+$  in the body has the same precedence as the lookahead, but is left associative. With lookahead  $*$ , we would prefer to shift, because the lookahead has higher precedence than the  $+$  in the production.

In those situations where the rightmost terminal does not supply the proper precedence to a production, we can force a precedence by appending to a production the tag

```
%prec (terminal)
```

The precedence and associativity of the production will then be the same as that of the terminal, which presumably is defined in the declaration section. **Yacc** does not report shift/reduce conflicts that are resolved using this precedence and associativity mechanism.

This "terminal" can be a placeholder, like **UMINUS** in Fig. 4.59; this terminal is not returned by the lexical analyzer, but is declared solely to define a precedence for a production. In Fig. 4.59, the declaration

```
•/.right UMINUS
```

assigns to the token **UMINUS** a precedence that is higher than that of  $*$  and  $/$ . In the translation rules part, the tag:

```
%prec UMINUS
```

at the end of the production

```
expr : '-' expr
```

makes the unary-minus operator in this production have a higher precedence than any other operator.

### 4.9.3 Creating Yacc Lexical Analyzers with Lex

Lex was designed to produce lexical analyzers that could be used with **Yacc**. The Lex library 11 will provide a driver program named `yylexO`, the name required by **Yacc** for its lexical analyzer. If Lex is used to produce the lexical analyzer, we replace the routine `yylexO` in the third part of the **Yacc** specification by the statement

```
#include "lex.yy.c"
```

and we have each Lex action return a terminal known to **Yacc**. By using the `#include "lex.yy.c"` statement, the program `yylex` has access to **Yacc**'s names for tokens, since the Lex output file is compiled as part of the **Yacc** output file `y.tab.c`.

Under the UNIX system, if the Lex specification is in the file `first.l` and the **Yacc** specification in `second.y`, we can say

```
lex first.1
yacc second.y
cc y.tab.c -ly -ll
```

to obtain the desired translator.

The **Lex** specification in Fig. 4.60 can be used in place of the lexical analyzer in Fig. 4.59. The last pattern, meaning "any character," must be written `\n| .` since the dot in Lex matches any character except newline,

```
number    [0-9]+\e.?I [0-9]*\e. [0-9] +
7.7.
[ ]       { /* skip blanks */ }
{number}  { sscanf(yytext, "7,lf", &yy1val);
           return NUMBER; }
\n|.     { return yytext[0]; }
```

Figure 4.60: Lex specification for `yylexQ` in Fig. 4.59

#### 4.9.4 Error Recovery in Yacc

In **Yacc**, error recovery uses a form of error productions. First, the user decides what "major" nonterminals will have error recovery associated with them. Typical choices are some subset of the nonterminals generating expressions, statements, blocks, and functions. The user then adds to the grammar error productions of the form  $A \rightarrow \mathbf{error} a$ , where  $A$  is a major nonterminal and  $a$  is a string of grammar symbols, perhaps the empty string; **error** is a **Yacc** reserved word. **Yacc** will generate a parser from such a specification, treating the error productions as ordinary productions.

However, when the parser generated by **Yacc** encounters an error, it treats the states whose sets of items contain error productions in a special way. On encountering an error, **Yacc** pops symbols from its stack until it finds the top-most state on its stack whose underlying set of items includes an item of the form  $A \rightarrow \bullet \mathbf{error} a$ . The parser then "shifts" a fictitious token **error** onto the stack, as though it saw the token **error** on its input.

When `cc` is `e`, a reduction to  $A$  occurs immediately and the semantic action associated with the production  $A \rightarrow \bullet \mathbf{error} a$  (which might be a user-specified error-recovery routine) is invoked. The parser then discards input symbols until it finds an input symbol on which normal parsing can proceed.

If  $a$  is not empty, **Yacc** skips ahead on the input looking for a substring that can be reduced to  $a$ . If  $a$  consists entirely of terminals, then it looks for this string of terminals on the input, and "reduces" them by shifting them onto the stack. At this point, the parser will have **error**  $a$  on top of its stack. The parser will then reduce **error**  $a$  to  $A$ , and resume normal parsing.

For example, an error production of the form

```

%{
#include <ctype.h>
#include <stdio.h>
#define YYSTYPE double /* double type for Yacc stack */
'/.}
'/.token NUMBER

'/.left > + » '-'
'/.left >*' '/'
'/.right UMINUS
'/.

lines : lines expr >\n' { printf("%g\n", $2); }
      I lines '\n'
      I /* empty */
      I error '\n' { yyerror("reenter previous line:");
                    yyerrok; }

>
expr  : expr '+' expr { $$ = $1 + $3; }
      I expr '-' expr { $$ = $1 - $3; }
      I expr '*' expr { $$ = $1 * $3; }
      I expr '/' expr { $$ = $1 / $3; }
      I '(' expr ')' { $$ = $2; }
      I '-' expr %prec UMINUS { $$ = - $2; }
      | NUMBER

n
#include "lex.yy.c"

```

Figure 4.61: Desk calculator with error recovery

```
stmt -> error ;
```

would specify to the parser that it should skip just beyond the next semicolon on seeing an error, and assume that a statement had been found. The semantic routine for this error production would not need to manipulate the input, but could generate a diagnostic message and set a flag to inhibit generation of object code, for example.

Example 4.70: Figure 4.61 shows the **Yacc** desk calculator of Fig. 4.59 with the error production

```
lines : error '\n'
```

This error production causes the desk calculator to suspend normal parsing when a syntax error is found on an input line. On encountering the error,

the parser in the desk calculator starts popping symbols from its stack until it encounters a state that has a shift action on the token **error**. State 0 is such a state (in this example, it's the only such state), since its items include

$$lines \rightarrow y \bullet \mathbf{error} \backslash n'$$

Also, state 0 is always on the bottom of the stack. The parser shifts the token **error** onto the stack, and then proceeds to skip ahead in the input until it has found a newline character. At this point the parser shifts the newline onto the stack, reduces **error** '\n' to *lines*, and emits the diagnostic message "reenter previous line:". The special **Yacc** routine `yyerrok` resets the parser to its normal mode of operation. •

### 4.9.5 Exercises for Section 4.9

- ! **Exercise 4.9.1:** Write a **Yacc** program that takes boolean expressions as input [as given by the grammar of Exercise 4.2.2(g)] and produces the truth value of the expressions.
- ! **Exercise 4.9.2:** Write a **Yacc** program that takes lists (as defined by the grammar of Exercise 4.2.2(e), but with any single character as an element, not just *a*) and produces as output a linear representation of the same list; i.e., a single list of the elements, in the same order that they appear in the input.
- ! **Exercise 4.9.3:** Write a **Yacc** program that tells whether its input is a *palindrome* (sequence of characters that read the same forward and backward).
- ! **Exercise 4.9.4:** Write a **Yacc** program that takes regular expressions (as defined by the grammar of Exercise 4.2.2(d), but with any single character as an argument, not just *a*) and produces as output a transition table for a nondeterministic finite automaton recognizing the same language.

## 4.10 Summary of Chapter 4

- *Parsers.* A parser takes as input tokens from the lexical analyzer and treats the token names as terminal symbols of a context-free grammar. The parser then constructs a parse tree for its input sequence of tokens; the parse tree may be constructed figuratively (by going through the corresponding derivation steps) or literally.
- *Context-Free Grammars.* A grammar specifies a set of terminal symbols (inputs), another set of nonterminals (symbols representing syntactic constructs), and a set of productions, each of which gives a way in which strings represented by one nonterminal can be constructed from terminal symbols and strings represented by certain other nonterminals. A production consists of a head (the nonterminal to be replaced) and a body (the replacing string of grammar symbols).



- *Derivations.* The process of starting with the start-nonterminal of a grammar and successively replacing it by the body of one of its productions is called a derivation. If the leftmost (or rightmost) nonterminal is always replaced, then the derivation is called leftmost (respectively, rightmost).
- *Parse Trees.* A parse tree is a picture of a derivation, in which there is a node for each nonterminal that appears in the derivation. The children of a node are the symbols by which that nonterminal is replaced in the derivation. There is a one-to-one correspondence between parse trees, leftmost derivations, and rightmost derivations of the same terminal string.
- *Ambiguity.* A grammar for which some terminal string has two or more different parse trees, or equivalently two or more leftmost derivations or two or more rightmost derivations, is said to be ambiguous. In most cases of practical interest, it is possible to redesign an ambiguous grammar so it becomes an unambiguous grammar for the same language. However, ambiguous grammars with certain tricks applied sometimes lead to more efficient parsers.
- *Top-Down and Bottom-Up Parsing.* Parsers are generally distinguished by whether they work top-down (start with the grammar's start symbol and construct the parse tree from the top) or bottom-up (start with the terminal symbols that form the leaves of the parse tree and build the tree from the bottom). Top-down parsers include recursive-descent and LL parsers, while the most common forms of bottom-up parsers are LR parsers.
- *Design of Grammars.* Grammars suitable for top-down parsing often are harder to design than those used by bottom-up parsers. It is necessary to eliminate left-recursion, a situation where one nonterminal derives a string that begins with the same nonterminal. We also must left-factor — group productions for the same nonterminal that have a common prefix in the body.
- *Recursive-Descent Parsers.* These parsers use a procedure for each nonterminal. The procedure looks at its input and decides which production to apply for its nonterminal. Terminals in the body of the production are matched to the input at the appropriate time, while nonterminals in the body result in calls to their procedure. Backtracking, in the case when the wrong production was chosen, is a possibility.
- *LL(1) Parsers.* A grammar such that it is possible to choose the correct production with which to expand a given nonterminal, looking only at the next input symbol, is called LL(1). These grammars allow us to construct a predictive parsing table that gives, for each nonterminal and each lookahead symbol, the correct choice of production. Error correction can be facilitated by placing error routines in some or all of the table entries that have no legitimate production.

- *Shift-Reduce Parsing.* Bottom-up parsers generally operate by choosing, on the basis of the next input symbol (lookahead symbol) and the contents of the stack, whether to shift the next input onto the stack, or to reduce some symbols at the top of the stack. A reduce step takes a production body at the top of the stack and replaces it by the head of the production.
- 4- *Viable Prefixes.* In shift-reduce parsing, the stack contents are always a viable prefix — that is, a prefix of some right-sentential form that ends no further right than the end of the handle of that right-sentential form. The handle is the substring that was introduced in the last step of the rightmost derivation of that sentential form.
- *Valid Items.* An item is a production with a dot somewhere in the body. An item is valid for a viable prefix if the production of that item is used to generate the handle, and the viable prefix includes all those symbols to the left of the dot, but not those below.
- *LR Parsers.* Each of the several kinds of LR parsers operate by first constructing the sets of valid items (called LR states) for all possible viable prefixes, and keeping track of the state for each prefix on the stack. The set of valid items guide the shift-reduce parsing decision. We prefer to reduce if there is a valid item with the dot at the right end of the body, and we prefer to shift the lookahead symbol onto the stack if that symbol appears immediately to the right of the dot in some valid item.
- *Simple LR Parsers.* In an SLR parser, we perform a reduction implied by a valid item with a dot at the right end, provided the lookahead symbol can follow the head of that production in some sentential form. The grammar is SLR, and this method can be applied, if there are no parsing-action conflicts; that is, for no set of items, and for no lookahead symbol, are there two productions to reduce by, nor is there the option to reduce or to shift.
- *Canonical-LR Parsers.* This more complex form of LR parser uses items that are augmented by the set of lookahead symbols that can follow the use of the underlying production. Reductions are only chosen when there is a valid item with the dot at the right end, and the current lookahead symbol is one of those allowed for this item. A canonical-LR parser can avoid some of the parsing-action conflicts that are present in SLR parsers, but often has many more states than the SLR parser for the same grammar.
- *Lookahead-LR Parsers.* LALR parsers offer many of the advantages of SLR and Canonical-LR parsers, by combining the states that have the same kernels (sets of items, ignoring the associated lookahead sets). Thus, the number of states is the same as that of the SLR parser, but some parsing-action conflicts present in the SLR parser may be removed in the LALR parser. LALR parsers have become the method of choice in practice.

- *Bottom-Up Parsing of Ambiguous Grammars.* In many important situations, such as parsing arithmetic expressions, we can use an ambiguous grammar, and exploit side information such as the precedence of operators to resolve conflicts between shifting and reducing, or between reduction by two different productions. Thus, LR parsing techniques extend to many ambiguous grammars.
- **Yacc.** The parser-generator **Yacc** takes a (possibly) ambiguous grammar and conflict-resolution information and constructs the LALR states. It then produces a function that uses these states to perform a bottom-up parse and call an associated function each time a reduction is performed.

## 4.11 References for Chapter 4

The context-free grammar formalism originated with Chomsky [5], as part of a study on natural language. The idea also was used in the syntax description of two early languages: Fortran by Backus [2] and Algol 60 by Naur [26]. The scholar Panini devised an equivalent syntactic notation to specify the rules of Sanskrit grammar between 400 B.C. and 200 B.C. [19].

The phenomenon of ambiguity was observed first by Cantor [4] and Floyd [13]. Chomsky Normal Form (Exercise 4.4.8) is from [6]. The theory of context-free grammars is summarized in [17].

Recursive-descent parsing was the method of choice for early compilers, such as [16], and compiler-writing systems, such as META [28] and TMG [25]. LL grammars were introduced by Lewis and Stearns [24]. Exercise 4.4.5, the linear-time simulation of recursive-descent, is from [3].

One of the earliest parsing techniques, due to Floyd [14], involved the precedence of operators. The idea was generalized to parts of the language that do not involve operators by Wirth and Weber [29]. These techniques are rarely used today, but can be seen as leading in a chain of improvements to LR parsing.

LR parsers were introduced by Knuth [22], and the canonical-LR parsing tables originated there. This approach was not considered practical, because the parsing tables were larger than the main memories of typical computers of the day, until Korenjak [23] gave a method for producing reasonably sized parsing tables for typical programming languages. DeRemer developed the LALR [8] and SLR [9] methods that are in use today. The construction of LR parsing tables for ambiguous grammars came from [1] and [12].

Johnson's **Yacc** very quickly demonstrated the practicality of generating parsers with an LALR parser generator for production compilers. The manual for the **Yacc** parser generator is found in [20]. The open-source version, Bison, is described in [10]. A similar LALR-based parser generator called CUP [18] supports actions written in Java. Top-down parser generators include Antlr [27], a recursive-descent parser generator that accepts actions in C++, Java, or C#, and LLGen [15], which is an LL(1)-based generator.

Dain [7] gives a bibliography on syntax-error handling.

The general-purpose dynamic-programming parsing algorithm described in Exercise 4.4.9 was invented independently by J. Cocke (unpublished) by Younger [30] and Kasami [21]; hence the "CYK algorithm." There is a more complex, general-purpose algorithm due to Earley [11] that tabulates LR-items for each substring of the given input; this algorithm, while also  $O(n^3)$  in general, is only  $O(n^2)$  on unambiguous grammars.

1. Aho, A. V., S. C. Johnson, and J. D. Ullman, "Deterministic parsing of ambiguous grammars," *Comm. ACM* 18:8 (Aug., 1975), pp. 441-452.
2. Backus, J.W., "The syntax and semantics of the proposed international algebraic language of the Zurich-ACM-GAMM Conference," *Proc. Intl. Conf. Information Processing*, UNESCO, Paris, (1959) pp. 125-132.
3. Birman, A. and J. D. Ullman, "Parsing algorithms with backtrack," *Information and Control* 23:1 (1973), pp. 1-34.
4. Cantor, D. C., "On the ambiguity problem of Backus systems," *J. ACM* 9:4 (1962), pp. 477-479.
5. Chomsky, N., "Three models for the description of language," *IRE Trans. on Information Theory* IT-2:3 (1956), pp. 113-124.
6. Chomsky, N., "On certain formal properties of grammars," *Information and Control* 2:2 (1959), pp. 137-167.
7. Dain, J., "Bibliography on Syntax Error Handling in Language Translation Systems," 1991. Available from the comp.compilers newsgroup; see <http://compilers.iecc.com/comparch/article/91-04-050> .
8. DeRemer, F., "Practical Translators for LR(fc) Languages," Ph.D. thesis, MIT, Cambridge, MA, 1969.
9. DeRemer, F., "Simple LR(fc) grammars," *Comm. ACM* 14:7 (July, 1971), pp. 453-460.
10. Donnelly, C. and R. Stallman, "Bison: The YACC-compatible Parser Generator," <http://www.gnu.org/software/bison/manual/> .
11. Earley, J., "An efficient context-free parsing algorithm," *Comm. ACM* 13:2 (Feb., 1970), pp. 94-102.
12. Earley, J., "Ambiguity and precedence in syntax description," *Acta Information* 4:2 (1975), pp. 183-192.
13. Floyd, R. W., "On ambiguity in phrase-structure languages," *Comm. ACM* 5:10 (Oct., 1962), pp. 526-534.
14. Floyd, R. W., "Syntactic analysis and operator precedence," *J. ACM* 10:3 (1963), pp. 316-333.

15. Grune, D and C. J. H. Jacobs, "A programmer-friendly LL(1) parser generator," *Software Practice and Experience* 18:1 (Jan., 1988), pp. 29–38. See also <http://www.cs.vu.nl/~ceriel/LLgen.html>.
16. Hoare, C. A. R., "Report on the Elliott Algol translator," *Computer J.* 5:2 (1962), pp. 127-129.
17. Hopcroft, J. E., R. Motwani, and J. D. Ullman, *Introduction to Automata Theory, Languages, and Computation*, Addison-Wesley, Boston MA, 2001.
18. Hudson, S. E. et al., "CUP LALR Parser Generator in Java," Available at <http://www2.cs.tum.edu/projects/cup/>.
19. Ingerman, P. Z., "Panini-Backus form suggested," *Comm. ACM* 10:3 (March 1967), p. 137.
20. Johnson, S. C., "Yacc — Yet Another Compiler Compiler," Computing Science Technical Report 32, Bell Laboratories, Murray Hill, NJ, 1975. Available at <http://dinosaur.compilertools.net/yacc/>.
21. Kasami, T., "An efficient recognition and syntax analysis algorithm for context-free languages," AFCRL-65-758, Air Force Cambridge Research Laboratory, Bedford, MA, 1965.
22. Knuth, D. E., "On the translation of languages from left to right," *Information and Control* 8:6 (1965), pp. 607-639.
23. Korenjak, A. J., "A practical method for constructing LR(fc) processors," *Comm. ACM* 12:11 (Nov., 1969), pp. 613-623.
24. Lewis, P. M. II and R. E. Stearns, "syntax-directed transduction," *J. ACM* 15:3 (1968), pp. 465-488.
25. McClure, R. M., "TMG — a syntax-directed compiler," *proc. 20th ACM Natl. Conf.* (1965), pp. 262-274.
26. Naur, P. et al., "Report on the algorithmic language ALGOL 60," *Comm. ACM* 3:5 (May, 1960), pp. 299-314. See also *Comm. ACM* 6:1 (Jan., 1963), pp. 1-17.
27. Parr, T., "ANTLR," <http://www.antlr.org/>.
28. Schorre, D. V., "Meta-II: a syntax-oriented compiler writing language," *Proc. 19th ACM Natl. Conf.* (1964) pp. D1.3-1-D1.3-11.
29. Wirth, N. and H. Weber, "Euler: a generalization of Algol and its formal definition: Part I," *Comm. ACM* 9:1 (Jan., 1966), pp. 13-23.
30. Younger, D.H., "Recognition and parsing of context-free languages in time  $n^3$ ," *Information and Control* 10:2 (1967), pp. 189-208.

## Chapter 5

# Syntax-Directed Translation

This chapter develops the theme of Section 2.3: the translation of languages guided by context-free grammars. The translation techniques in this chapter will be applied in Chapter 6 to type checking and intermediate-code generation. The techniques are also useful for implementing little languages for specialized tasks; this chapter includes an example from typesetting.

We associate information with a language construct by attaching *attributes* to the grammar symbol(s) representing the construct, as discussed in Section 2.3.2. A syntax-directed definition specifies the values of attributes by associating semantic rules with the grammar productions. For example, an infix-to-postfix translator might have a production and rule

$$\begin{array}{ll} \text{PRODUCTION} & \text{SEMANTIC RULE} \\ E \rightarrow E_i + T & E.code = E_i.code \parallel T.code \parallel '+' \end{array} \quad (5.1)$$

This production has two nonterminals,  $E$  and  $T$ ; the subscript in  $E_i$  distinguishes the occurrence of  $E$  in the production body from the occurrence of  $E$  as the head. Both  $E$  and  $T$  have a string-valued attribute *code*. The semantic rule specifies that the string  $E.code$  is formed by concatenating  $E_i.code$ ,  $T.code$ , and the character '+'. While the rule makes it explicit that the translation of  $E$  is built up from the translations of  $E_i$ ,  $T$ , and '+', it may be inefficient to implement the translation directly by manipulating strings.

From Section 2.3.5, a syntax-directed translation scheme embeds program fragments called semantic actions within production bodies, as in

$$E \rightarrow E_i + T \quad \{ \text{print '+'} \} \quad (5.2)$$

By convention, semantic actions are enclosed within curly braces. (If curly braces occur as grammar symbols, we enclose them within single quotes, as in

'{' and '}').) The position of a semantic action in a production body determines the order in which the action is executed. In production (5.2), the action occurs at the end, after all the grammar symbols; in general, semantic actions may occur at any position in a production body.

Between the two notations, syntax-directed definitions can be more readable, and hence more useful for specifications. However, translation schemes can be more efficient, and hence more useful for implementations.

The most general approach to syntax-directed translation is to construct a parse tree or a syntax tree, and then to compute the values of attributes at the nodes of the tree by visiting the nodes of the tree. In many cases, translation can be done during parsing, without building an explicit tree. We shall therefore study a class of syntax-directed translations called "L-attributed translations" (L for left-to-right), which encompass virtually all translations that can be performed during parsing. We also study a smaller class, called "S-attributed translations" (S for synthesized), which can be performed easily in connection with a bottom-up parse.

## 5.1 Syntax-Directed Definitions

A *syntax-directed definition* (SDD) is a context-free grammar together with attributes and rules. Attributes are associated with grammar symbols and rules are associated with productions. If  $X$  is a symbol and  $a$  is one of its attributes, then we write  $X.a$  to denote the value of  $a$  at a particular parse-tree node labeled  $X$ . If we implement the nodes of the parse tree by records or objects, then the attributes of  $X$  can be implemented by data fields in the records that represent the nodes for  $X$ . Attributes may be of any kind: numbers, types, table references, or strings, for instance. The strings may even be long sequences of code, say code in the intermediate language used by a compiler.

### 5.1.1 Inherited and Synthesized Attributes

We shall deal with two kinds of attributes for nonterminals:

1. A *synthesized attribute* for a nonterminal  $A$  at a parse-tree node  $N$  is defined by a semantic rule associated with the production at  $N$ . Note that the production must have  $A$  as its head. A synthesized attribute at node  $N$  is defined only in terms of attribute values at the children of  $N$  and at  $N$  itself.
2. An *inherited attribute* for a nonterminal  $B$  at a parse-tree node  $N$  is defined by a semantic rule associated with the production at the parent of  $N$ . Note that the production must have  $B$  as a symbol in its body. An inherited attribute at node  $N$  is defined only in terms of attribute values at  $N$ 's parent,  $N$  itself, and  $N$ 's siblings.

### An Alternative Definition of Inherited Attributes

No additional translations are enabled if we allow an inherited attribute  $B.c$  at a node  $N$  to be defined in terms of attribute values at the children of  $A'$ , as well as at  $N$  itself, at its parent, and at its siblings. Such rules can be "simulated" by creating additional attributes of  $B$ , say  $B.ci, B.cj, \dots$ . These are synthesized attributes that copy the needed attributes of the children of the node labeled  $B$ . We then compute  $B.c$  as an inherited attribute, using the attributes  $B.ci, B.cj, \dots$  in place of attributes at the children. Such attributes are rarely needed in practice.

While we do not allow an inherited attribute at node  $N$  to be defined in terms of attribute values at the children of node  $N$ , we do allow a synthesized attribute at node  $N$  to be defined in terms of inherited attribute values at node  $N$  itself.

Terminals can have synthesized attributes, but not inherited attributes. Attributes for terminals have lexical values that are supplied by the lexical analyzer; there are no semantic rules in the SDD itself for computing the value of an attribute for a terminal.

**Example 5.1:** The SDD in Fig. 5.1 is based on our familiar grammar for arithmetic expressions with operators  $+$  and  $*$ . It evaluates expressions terminated by an endmarker  $\mathbf{n}$ . In the SDD, each of the nonterminals has a single synthesized attribute, called *val*. We also suppose that the terminal **digit** has a synthesized attribute *lexval*, which is an integer value returned by the lexical analyzer.

PRODUCTION	SEMANTIC RULES
1) $L \rightarrow E \mathbf{n}$	$L.val = E.val$
2) $E \rightarrow E_1 + T$	$E.val = E_1.val + T.val$
3) $E \rightarrow T$	$E.val = T.val$
4) $T \rightarrow T_1 * F$	$T.val = T_1.val \times F.val$
5) $T \rightarrow F$	$T.val = F.val$
6) $F \rightarrow \gamma(E)$	$F.val = E.val$
7) $F \rightarrow \mathbf{digit}$	$F.val = \mathbf{digit.lexval}$

Figure 5.1: Syntax-directed definition of a simple desk calculator

The rule for production 1,  $L \rightarrow \bullet E \mathbf{n}$ , sets  $L.val$  to  $E.val$ , which we shall see is the numerical value of the entire expression.

Production 2,  $E \rightarrow E_1 + T$ , also has one rule, which computes the *val* attribute for the head  $E$  as the sum of the values at  $E_1$  and  $T$ . At any parse-



tree node  $N$  labeled  $E$ , the value of  $val$  for  $E$  is the sum of the values of  $val$  at the children of node  $N$  labeled  $E$  and  $T$ .

Production 3,  $E \rightarrow T$ , has a single rule that defines the value of  $val$  for  $E$  to be the same as the value of  $val$  at the child for  $T$ . Production 4 is similar to the second production; its rule multiplies the values at the children instead of adding them. The rules for productions 5 and 6 copy values at a child, like that for the third production. Production 7 gives  $F.val$  the value of a digit, that is, the numerical value of the token digit that the lexical analyzer returned. •

An SDD that involves only synthesized attributes is called *S-attributed*; the SDD in Fig. 5.1 has this property. In an S-attributed SDD, each rule computes an attribute for the nonterminal at the head of a production from attributes taken from the body of the production.

For simplicity, the examples in this section have semantic rules without side effects. In practice, it is convenient to allow SDD's to have limited side effects, such as printing the result computed by a desk calculator or interacting with a symbol table. Once the order of evaluation of attributes is discussed in Section 5.2, we shall allow semantic rules to compute arbitrary functions, possibly involving side effects.

An S-attributed SDD can be implemented naturally in conjunction with an LR parser. In fact, the SDD in Fig. 5.1 mirrors the Yacc program of Fig. 4.58, which illustrates translation during LR parsing. The difference is that, in the rule for production 1, the Yacc program prints the value  $E.val$  as a side effect, instead of defining the attribute  $L.val$ .

An SDD without side effects is sometimes called an *attribute grammar*. The rules in an attribute grammar define the value of an attribute purely in terms of the values of other attributes and constants.

## 5.1.2 Evaluating an SDD at the Nodes of a Parse Tree

To visualize the translation specified by an SDD, it helps to work with parse trees, even though a translator need not actually build a parse tree. Imagine therefore that the rules of an SDD are applied by first constructing a parse tree and then using the rules to evaluate all of the attributes at each of the nodes of the parse tree. A parse tree, showing the value(s) of its attribute(s) is called an *annotated parse tree*.

How do we construct an annotated parse tree? In what order do we evaluate attributes? Before we can evaluate an attribute at a node of a parse tree, we must evaluate all the attributes upon which its value depends. For example, if all attributes are synthesized, as in Example 5.1, then we must evaluate the  $val$  attributes at all of the children of a node before we can evaluate the  $val$  attribute at the node itself.

With synthesized attributes, we can evaluate attributes in any bottom-up order, such as that of a postorder traversal of the parse tree; the evaluation of S-attributed definitions is discussed in Section 5.2.3.

For SDD's with both inherited and synthesized attributes, there is no guarantee that there is even one order in which to evaluate attributes at nodes. For instance, consider nonterminals  $A$  and  $B$ , with synthesized and inherited attributes  $A.s$  and  $BA$ , respectively, along with the production and rules

PRODUCTION	SEMANTIC RULES
$A \wedge B$	$A.s = B.i;$ $B.i = A.s + 1$

These rules are circular; it is impossible to evaluate either  $A.s$  at a node  $N$  or  $BA$  at the child of  $N$  without first evaluating the other. The circular dependency of  $A.s$  and  $BA$  at some pair of nodes in a parse tree is suggested by Fig. 5.2.

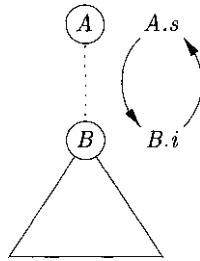

Figure 5.2: The circular dependency of  $A.s$  and  $BA$  on one another

It is computationally difficult to determine whether or not there exist any circularities in any of the parse trees that a given SDD could have to translate.<sup>1</sup> Fortunately, there are useful subclasses of SDD's that are sufficient to guarantee that an order of evaluation exists, as we shall see in Section 5.2.

Example 5.2: Figure 5.3 shows an annotated parse tree for the input string  $3 * 5 + 4 \mathbf{n}$ , constructed using the grammar and rules of Fig. 5.1. The values of  $lexval$  are presumed supplied by the lexical analyzer. Each of the nodes for the nonterminals has attribute  $val$  computed in a bottom-up order, and we see the resulting values associated with each node. For instance, at the node with a child labeled  $*$ , after computing  $T.val = 3$  and  $F.val = 5$  at its first and third children, we apply the rule that says  $T.val$  is the product of these two values, or 15. •

Inherited attributes are useful when the structure of a parse tree does not "match" the abstract syntax of the source code. The next example shows how inherited attributes can be used to overcome such a mismatch due to a grammar designed for parsing rather than translation.

<sup>1</sup>Without going into details, while the problem is decidable, it cannot be solved by a polynomial-time algorithm, even if  $V = NT$ , since it has exponential time complexity.

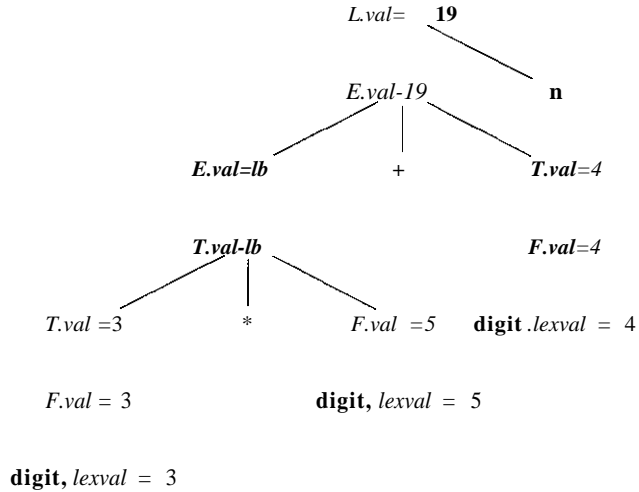
Figure 5.3: Annotated parse tree for  $3 * 5 + 4 n$ 

Example 5.3: The SDD in Fig. 5.4 computes terms like  $3 * 5$  and  $3 * 5 * 7$ . The top-down parse of input  $3 * 5$  begins with the production  $T \rightarrow FT'$ . Here,  $F$  generates the digit 3, but the operator  $*$  is generated by  $X'$ . Thus, the left operand 3 appears in a different subtree of the parse tree from  $*$ . An inherited attribute will therefore be used to pass the operand to the operator.

The grammar in this example is an excerpt from a non-left-recursive version of the familiar expression grammar; we used such a grammar as a running example to illustrate top-down parsing in Section 4.4.

PRODUCTION	SEMANTIC RULES
1) $T \rightarrow FT'$	$T'.inh = F.val$ $T.val = T'.syn$
2) $T' \rightarrow *FT'$	$T[inh] = T'.inh \times F.val$ $T'.syn = T[.syn]$
3) $T' \rightarrow e$	$T'.syn = T'.inh$
4) $F \rightarrow \mathbf{digit}$	$F.val = \mathbf{digit}, lexval$

Figure 5.4: An SDD based on a grammar suitable for top-down parsing

Each of the nonterminals  $T$  and  $F$  has a synthesized attribute  $val$ ; the terminal **digit** has a synthesized attribute  $lexval$ . The nonterminal  $T$  has two attributes: an inherited attribute  $inh$  and a synthesized attribute  $syn$ .

The semantic rules are based on the idea that the left operand of the operator  $*$  is inherited. More precisely, the head  $T''$  of the production  $T' \rightarrow * F T_1'$  inherits the left operand of  $*$  in the production body. Given a term  $x * y * z$ , the root of the subtree for  $* y * z$  inherits  $x$ . Then, the root of the subtree for  $* z$  inherits the value of  $x * y$ , and so on, if there are more factors in the term. Once all the factors have been accumulated, the result is passed back up the tree using synthesized attributes.

To see how the semantic rules are used, consider the annotated parse tree for  $3 * 5$  in Fig. 5.5. The leftmost leaf in the parse tree, labeled **digit**, has attribute value  $lexval = 3$ , where the 3 is supplied by the lexical analyzer. Its parent is for production 4,  $F \rightarrow \mathbf{digit}$ . The only semantic rule associated with this production defines  $F.val = \mathbf{digit}.lexval$ , which equals 3.

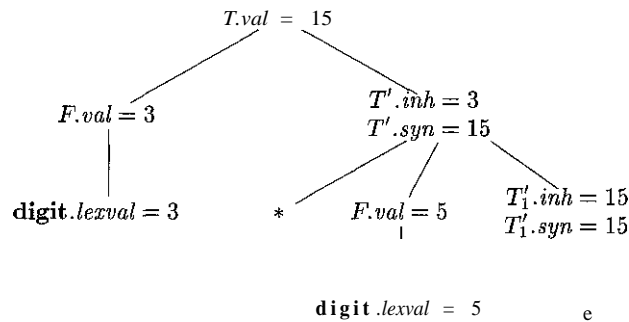

Figure 5.5: Annotated parse tree for  $3 * 5$

At the second child of the root, the inherited attribute  $T'.inh$  is defined by the semantic rule  $T'.inh = F.val$  associated with production 1. Thus, the left operand, 3, for the  $*$  operator is passed from left to right across the children of the root.

The production at the node for  $V$  is  $X'' \rightarrow * F T_1'$ . (We retain the subscript 1 in the annotated parse tree to distinguish between the two nodes for  $T'$ .) The inherited attribute  $T_1'.inh$  is defined by the semantic rule  $T_1'.inh = T'.inh * F.val$  associated with production 2.

With  $T'.inh = 3$  and  $F.val = 5$ , we get  $T_1'.inh = 15$ . At the lower node for  $T_1'$ , the production is  $T'' \rightarrow e$ . The semantic rule  $T_1'.syn = T_1'.inh$  defines  $T_1'.syn = 15$ . The  $syn$  attributes at the nodes for  $X''$  pass the value 15 up the tree to the node for  $X$ , where  $T.val = 15$ . •

### 5.1.3 Exercises for Section 5.1

**Exercise 5.1.1:** For the SDD of Fig. 5.1, give annotated parse trees for the following expressions:

- a)  $(3 + 4) * (5 + 6)$ .

b)  $1 * 2 * 3 * (4 + 5) \mathbf{n}$ .

c)  $(9 + 8 * (7 + 6) + 5) * 4 \mathbf{n}$ .

Exercise 5.1.2: Extend the SDD of Fig. 5.4 to handle expressions as in Fig. 5.1.

Exercise 5.1.3: Repeat Exercise 5.1.1, using your SDD from Exercise 5.1.2.

## 5.2 Evaluation Orders for SDD's

"Dependency graphs" are a useful tool for determining an evaluation order for the attribute instances in a given parse tree. While an annotated parse tree shows the values of attributes, a dependency graph helps us determine how those values can be computed.

In this section, in addition to dependency graphs, we define two important classes of SDD's: the "S-attributed" and the more general "L-attributed" SDD's. The translations specified by these two classes fit well with the parsing methods we have studied, and most translations encountered in practice can be written to conform to the requirements of at least one of these classes.

### 5.2.1 Dependency Graphs

A *dependency graph* depicts the flow of information among the attribute instances in a particular parse tree; an edge from one attribute instance to another means that the value of the first is needed to compute the second. Edges express constraints implied by the semantic rules. In more detail:

- For each parse-tree node, say a node labeled by grammar symbol  $X$ , the dependency graph has a node for each attribute associated with  $X$ .
- Suppose that a semantic rule associated with a production  $p$  defines the value of synthesized attribute  $A.b$  in terms of the value of  $X.c$  (the rule may define  $A.b$  in terms of other attributes in addition to  $X.c$ ). Then, the dependency graph has an edge from  $X.c$  to  $A.b$ . More precisely, at every node  $N$  labeled  $A$  where production  $p$  is applied, create an edge to attribute  $b$  at  $N$ , from the attribute  $c$  at the child of  $N$  corresponding to this instance of the symbol  $X$  in the body of the production.<sup>2</sup>
- Suppose that a semantic rule associated with a production  $p$  defines the value of inherited attribute  $B.c$  in terms of the value of  $X.a$ . Then, the dependency graph has an edge from  $X.a$  to  $B.c$ . For each node  $N$  labeled  $B$  that corresponds to an occurrence of this  $B$  in the body of production  $p$ , create an edge to attribute  $c$  at  $N$  from the attribute  $a$  at the node  $M$

<sup>2</sup> Since a node  $N$  can have several children labeled  $X$ , we again assume that subscripts distinguish among uses of the same symbol at different places in the production.

that corresponds to this occurrence of  $X$ . Note that  $M$  could be either the parent or a sibling of  $N$ .

Example 5.4: Consider the following production and rule:

PRODUCTION	SEMANTIC RULE
$E \rightarrow E_i + T$	$E.val = E_i.val + T.val$

At every node  $N$  labeled  $E$ , with children corresponding to the body of this production, the synthesized attribute  $val$  at  $N$  is computed using the values of  $val$  at the two children, labeled  $E$  and  $T$ . Thus, a portion of the dependency graph for every parse tree in which this production is used looks like Fig. 5.6. As a convention, we shall show the parse tree edges as dotted lines, while the edges of the dependency graph are solid. •

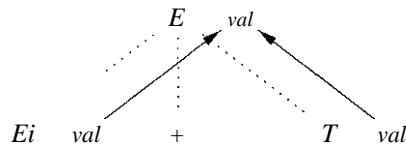

Figure 5.6:  $E.val$  is synthesized from  $E_i.val$  and  $E_i.val$

Example 5.5: An example of a complete dependency graph appears in Fig. 5.7. The nodes of the dependency graph, represented by the numbers 1 through 9, correspond to the attributes in the annotated parse tree in Fig. 5.5.

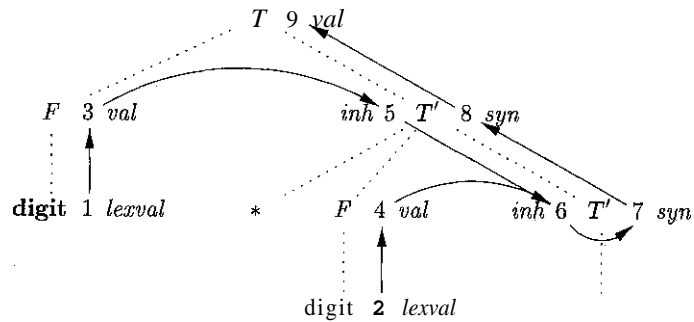

Figure 5.7: Dependency graph for the annotated parse tree of Fig. 5.5

Nodes 1 and 2 represent the attribute  $lexval$  associated with the two leaves labeled  $digit$ . Nodes 3 and 4 represent the attribute  $val$  associated with the two nodes labeled  $F$ . The edges to node 3 from 1 and to node 4 from 2 result

from the semantic rule that defines  $F.val$  in terms of  $digit.lexval$ . In fact,  $F.val$  equals  $digit.lexval$ , but the edge represents dependence, not equality.

Nodes 5 and 6 represent the inherited attribute  $T'.inh$  associated with each of the occurrences of nonterminal  $T'$ . The edge to 5 from 3 is due to the rule  $T'.inh = F.val$ , which defines  $T'.inh$  at the right child of the root from  $F.val$  at the left child. We see edges to 6 from node 5 for  $T'.inh$  and from node 4 for  $F.val$ , because these values are multiplied to evaluate the attribute  $inh$  at node 6.

Nodes 7 and 8 represent the synthesized attribute  $syn$  associated with the occurrences of  $X''$ . The edge to node 7 from 6 is due to the semantic rule  $T'.syn = T'.inh$  associated with production 3 in Fig. 5.4. The edge to node 8 from 7 is due to a semantic rule associated with production 2.

Finally, node 9 represents the attribute  $T.val$ . The edge to 9 from 8 is due to the semantic rule,  $T.val = T'.syn$ , associated with production 1. •

## 5.2.2 Ordering the Evaluation of Attributes

The dependency graph characterizes the possible orders in which we can evaluate the attributes at the various nodes of a parse tree. If the dependency graph has an edge from node  $M$  to node  $N$ , then the attribute corresponding to  $M$  must be evaluated before the attribute of  $N$ . Thus, the only allowable orders of evaluation are those sequences of nodes  $N_1, N_2, \dots, N_k$  such that if there is an edge of the dependency graph from  $N_i$  to  $N_j$ , then  $i < j$ . Such an ordering embeds a directed graph into a linear order, and is called a *topological sort* of the graph.

If there is any cycle in the graph, then there are no topological sorts; that is, there is no way to evaluate the SDD on this parse tree. If there are no cycles, however, then there is always at least one topological sort. To see why, since there are no cycles, we can surely find a node with no edge entering. For if there were no such node, we could proceed from predecessor to predecessor until we came back to some node we had already seen, yielding a cycle. Make this node the first in the topological order, remove it from the dependency graph, and repeat the process on the remaining nodes.

**Example 5.6:** The dependency graph of Fig. 5.7 has no cycles. One topological sort is the order in which the nodes have already been numbered: 1, 2, ..., 9. Notice that every edge of the graph goes from a node to a higher-numbered node, so this order is surely a topological sort. There are other topological sorts as well, such as 1, 3, 5, 2, 4, 6, 7, 8, 9. •

## 5.2.3 S-Attributed Definitions

As mentioned earlier, given an SDD, it is very hard to tell whether there exist any parse trees whose dependency graphs have cycles. In practice, translations can be implemented using classes of SDD's that guarantee an evaluation order,

since they do not permit dependency graphs with cycles. Moreover, the two classes introduced in this section can be implemented efficiently in connection with top-down or bottom-up parsing.

The first class is defined as follows:

- An SDD is *S-attributed* if every attribute is synthesized.

**Example 5.7:** The SDD of Fig. 5.1 is an example of an S-attributed definition. Each attribute, *L.val*, *E.val*, *T.val*, and *F.val* is synthesized. •

When an SDD is S-attributed, we can evaluate its attributes in any bottom-up order of the nodes of the parse tree. It is often especially simple to evaluate the attributes by performing a postorder traversal of the parse tree and evaluating the attributes at a node *N* when the traversal leaves *N* for the last time. That is, we apply the function *postorder*, defined below, to the root of the parse tree (see also the box "Preorder and Postorder Traversals" in Section 2.3.4):

```

postorder(N)  {
                for ( each child C of N, from the left ) postorder(C);
                evaluate the attributes associated with node N;
            }

```

S-attributed definitions can be implemented during bottom-up parsing, since a bottom-up parse corresponds to a postorder traversal. Specifically, postorder corresponds exactly to the order in which an LR parser reduces a production body to its head. This fact will be used in Section 5.4.2 to evaluate synthesized attributes and store them on the stack during LR parsing, without creating the tree nodes explicitly.

#### 5.2.4 L-Attributed Definitions

The second class of SDD's is called *L-attributed definitions*. The idea behind this class is that, between the attributes associated with a production body, dependency-graph edges can go from left to right, but not from right to left (hence "L-attributed"). More precisely, each attribute must be either

1. Synthesized, or
2. Inherited, but with the rules limited as follows. Suppose that there is a production  $A \rightarrow X_1 X_2 \dots X_n$ , and that there is an inherited attribute  $X_i.a$  computed by a rule associated with this production. Then the rule may use only:
  - (a) Inherited attributes associated with the head *A*.
  - (b) Either inherited or synthesized attributes associated with the occurrences of symbols  $X_1, X_2, \dots, X^i$  located to the left of  $X_i$ .



- (c) Inherited or synthesized attributes associated with this occurrence of  $X_i$  itself, but only in such a way that there are no cycles in a dependency graph formed by the attributes of this  $X_j$ .

Example 5.8: The SDD in Fig. 5.4 is L-attributed. To see why, consider the semantic rules for inherited attributes, which are repeated here for convenience:

PRODUCTION	SEMANTIC RULE
$T \rightarrow FT'$	$T.inh = F.val$
$T' \rightarrow *F T[$	$T[.inh = T'.inh \times F.val$

The first of these rules defines the inherited attribute  $T.inh$  using only  $F.val$ , and  $F$  appears to the left of  $T'$  in the production body, as required. The second rule defines  $T[.inh$  using the inherited attribute  $T'.inh$  associated with the head, and  $F.val$ , where  $F$  appears to the left of  $T[$  in the production body.

In each of these cases, the rules use information "from above or from the left," as required by the class. The remaining attributes are synthesized. Hence, the SDD is L-attributed. •

Example 5.9: Any SDD containing the following production and rules cannot be L-attributed:

PRODUCTION	SEMANTIC RULES
$A \rightarrow B C$	$A.s = B.b;$
	$B.i = f(C.c, A.s)$

The first rule,  $A.s = B.b$ , is a legitimate rule in either an S-attributed or L-attributed SDD. It defines a synthesized attribute  $A.s$  in terms of an attribute at a child (that is, a symbol within the production body).

The second rule defines an inherited attribute  $B.i$ , so the entire SDD cannot be S-attributed. Further, although the rule is legal, the SDD cannot be L-attributed, because the attribute  $C.c$  is used to help define  $B.i$ , and  $C$  is to the right of  $B$  in the production body. While attributes at siblings in a parse tree may be used in L-attributed SDD's, they must be to the left of the symbol whose attribute is being defined. •

### 5.2.5 Semantic Rules with Controlled Side Effects

In practice, translations involve side effects: a desk calculator might print a result; a code generator might enter the type of an identifier into a symbol table. With SDD's, we strike a balance between attribute grammars and translation schemes. Attribute grammars have no side effects and allow any evaluation order consistent with the dependency graph. Translation schemes impose left-to-right evaluation and allow semantic actions to contain any program fragment; translation schemes are discussed in Section 5.4.

We shall control side effects in SDD's in one of the following ways:

- Permit incidental side effects that do not constrain attribute evaluation. In other words, permit side effects when attribute evaluation based on any topological sort of the dependency graph produces a "correct" translation, where "correct" depends on the application.
- Constrain the allowable evaluation orders, so that the same translation is produced for any allowable order. The constraints can be thought of as implicit edges added to the dependency graph.

As an example of an incidental side effect, let us modify the desk calculator of Example 5.1 to print a result. Instead of the rule  $L.val = E.val$ , which saves the result in the synthesized attribute  $L.val$ , consider:

PRODUCTION	SEMANTIC RULE
1) $L \rightarrow E n$	$print(E.val)$

Semantic rules that are executed for their side effects, such as  $print(E.val)$ , will be treated as the definitions of dummy synthesized attributes associated with the head of the production. The modified SDD produces the same translation under any topological sort, since the print statement is executed at the end, after the result is computed into  $E.val$ .

Example 5.10: The SDD in Fig. 5.8 takes a simple declaration  $D$  consisting of a basic type  $T$  followed by a list  $L$  of identifiers.  $T$  can be int or float. For each identifier on the list, the type is entered into the symbol-table entry for the identifier. We assume that entering the type for one identifier does not affect the symbol-table entry for any other identifier. Thus, entries can be updated in any order. This SDD does not check whether an identifier is declared more than once; it can be modified to do so.

PRODUCTION	SEMANTIC RULES
1) $D \rightarrow TL$	$L.inh = T.type$
2) $T \rightarrow \text{int}$	$T.type = \text{integer}$
3) $T \rightarrow \text{float}$	$T.type = \text{float}$
4) $L \rightarrow Li, id$	$L.inh = L.inh$ $addType(id. entry, L.inh)$
5) $L \rightarrow Md$	$addType(id. entry, L.inh)$

Figure 5.8: Syntax-directed definition for simple type declarations

Nonterminal  $D$  represents a declaration, which, from production 1, consists of a type  $T$  followed by a list  $L$  of identifiers.  $T$  has one attribute,  $T.type$ , which is the type in the declaration  $D$ . Nonterminal  $L$  also has one attribute, which we call  $inh$  to emphasize that it is an inherited attribute. The purpose of  $L.inh$

is to pass the declared type down the list of identifiers, so that it can be added to the appropriate symbol-table entries.

Productions 2 and 3 each evaluate the synthesized attribute  $T.type$ , giving it the appropriate value, integer or float. This type is passed to the attribute  $L.inh$  in the rule for production 1. Production 4 passes  $L.inh$  down the parse tree. That is, the value  $L.inh$  is computed at a parse-tree node by copying the value of  $L.inh$  from the parent of that node; the parent corresponds to the head of the production.

Productions 4 and 5 also have a rule in which a function  $addType$  is called with two arguments:

1.  $id.entry$ , a lexical value that points to a symbol-table object, and
2.  $L.inh$ , the type being assigned to every identifier on the list.

We suppose that function  $addType$  properly installs the type  $L.inh$  as the type of the represented identifier.

A dependency graph for the input string **float idi, id, id**, appears in Fig. 5.9. Numbers 1 through 10 represent the nodes of the dependency graph. Nodes 1, 2, and 3 represent the attribute  $entry$  associated with each of the leaves labeled **id**. Nodes 6, 8, and 10 are the dummy attributes that represent the application of the function  $addType$  to a type and one of these  $entry$  values.

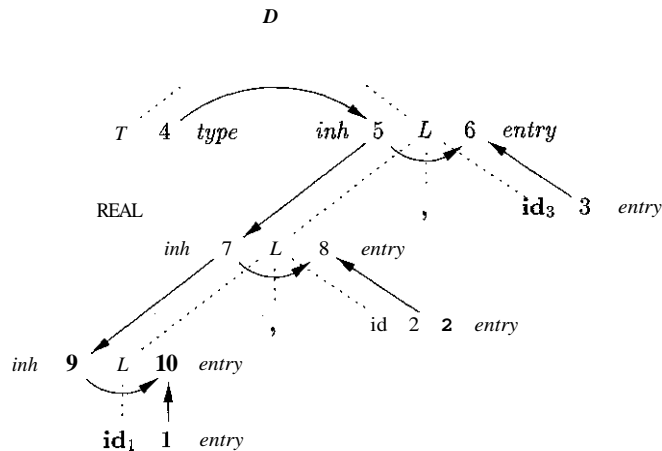

Figure 5.9: Dependency graph for a declaration **float idi, id, id**,

Node 4 represents the attribute  $T.type$ , and is actually where attribute evaluation begins. This type is then passed to nodes 5, 7, and 9 representing  $L.inh$  associated with each of the occurrences of the nonterminal  $L$ . •

### 5.2.6 Exercises for Section 5.2

**Exercise 5.2.1:** What are all the topological sorts for the dependency graph of Fig. 5.7?

**Exercise 5.2.2:** For the SDD of Fig. 5.8, give annotated parse trees for the following expressions:

a) int a, b, c.

b) float w, x, y, z.

**Exercise 5.2.3:** Suppose that we have a production  $A \rightarrow BCD$ . Each of the four nonterminals  $A$ ,  $B$ ,  $C$ , and  $D$  have two attributes:  $s$  is a synthesized attribute, and  $i$  is an inherited attribute. For each of the sets of rules below, tell whether (i) the rules are consistent with an S-attributed definition (ii) the rules are consistent with an L-attributed definition, and (iii) whether the rules are consistent with any evaluation order at all?

a)  $A.s = B.i + C.s$ .

b)  $A.s = B.i + C.s$  and  $D.i = A.i + B.s$ .

c)  $A.s = B.s + D.s$ .

! d)  $A.s = D.i$ ,  $B.i = A.s + C.s$ ,  $C.i = B.s$ , and  $D.i = B.i + C.i$ .

! **Exercise 5.2.4:** This grammar generates binary numbers with a "decimal" point:

$$\begin{aligned} S &\rightarrow L . L \mid L \\ L &\rightarrow LB \mid B \\ B &\rightarrow 0 \mid 1 \end{aligned}$$

Design an L-attributed SDD to compute  $S.val$ , the decimal-number value of an input string. For example, the translation of string 101.101 should be the decimal number 5.625. *Hint:* use an inherited attribute  $L.side$  that tells which side of the decimal point a bit is on.

!! **Exercise 5.2.5:** Design an S-attributed SDD for the grammar and translation described in Exercise 5.2.4.

!! **Exercise 5.2.6:** Implement Algorithm 3.23, which converts a regular expression into a nondeterministic finite automaton, by an L-attributed SDD on a top-down parsable grammar. Assume that there is a token **char** representing any character, and that  $char.lexval$  is the character it represents. You may also assume the existence of a function  $new()$  that returns a new state, that is, a state never before returned by this function. Use any convenient notation to specify the transitions of the NFA.

## 5.3 Applications of Syntax-Directed Translation

The syntax-directed translation techniques in this chapter will be applied in Chapter 6 to type checking and intermediate-code generation. Here, we consider selected examples to illustrate some representative SDD's.

The main application in this section is the construction of syntax trees. Since some compilers use syntax trees as an intermediate representation, a common form of SDD turns its input string into a tree. To complete the translation to intermediate code, the compiler may then walk the syntax tree, using another set of rules that are in effect an SDD on the syntax tree rather than the parse tree. (Chapter 6 also discusses approaches to intermediate-code generation that apply an SDD without ever constructing a tree explicitly.)

We consider two SDD's for constructing syntax trees for expressions. The first, an S-attributed definition, is suitable for use during bottom-up parsing. The second, L-attributed, is suitable for use during top-down parsing.

The final example of this section is an L-attributed definition that deals with basic and array types.

### 5.3.1 Construction of Syntax Trees

As discussed in Section 2.8.2, each node in a syntax tree represents a construct; the children of the node represent the meaningful components of the construct. A syntax-tree node representing an expression  $E \mid + E$ , has label  $+$  and two children representing the subexpressions  $E \mid$  and  $E$ .

We shall implement the nodes of a syntax tree by objects with a suitable number of fields. Each object will have an *op* field that is the label of the node. The objects will have additional fields as follows:

- If the node is a leaf, an additional field holds the lexical value for the leaf. A constructor function *Leaf*(*op*, *val*) creates a leaf object. Alternatively, if nodes are viewed as records, then *Leaf* returns a pointer to a new record for a leaf.
- If the node is an interior node, there are as many additional fields as the node has children in the syntax tree. A constructor function *Node* takes two or more arguments: *Node*(*op*, *c*<sub>1</sub>, *c*<sub>2</sub>, ..., *c*<sub>k</sub>) creates an object with first field *op* and *k* additional fields for the *k* children *c*<sub>1</sub>, ..., *c*<sub>k</sub>.

**Example 5.11:** The S-attributed definition in Fig. 5.10 constructs syntax trees for a simple expression grammar involving only the binary operators  $+$  and  $-$ . As usual, these operators are at the same precedence level and are jointly left associative. All nonterminals have one synthesized attribute *node*, which represents a node of the syntax tree.

Every time the first production  $E \mid E \mid + T$  is used, its rule creates a node with '+' for *op* and two children, *E*<sub>1</sub>.*node* and *T*.*node*, for the subexpressions. The second production has a similar rule.

PRODUCTION	SEMANTIC RULES
1) $E \rightarrow E_1 + T$	$E.node = \mathbf{new} \text{ Node}('+', E.node, T.node)$
2) $E \rightarrow E_1 - T$	$E.node = \mathbf{new} \text{ Node}('-', E_1.node, T.node)$
3) $E \rightarrow T$	$E.node = T.node$
4) $T \rightarrow (E)$	$T.node = E.node$
5) $T \rightarrow \mathbf{id}$	$T.node = \mathbf{new} \text{ Leaf}(id, id. \text{entry})$
6) $T \rightarrow \mathbf{num}$	$T.node = \mathbf{new} \text{ Leaf}(\mathbf{num}, \mathbf{num.rol})$

Figure 5.10: Constructing syntax trees for simple expressions

For production 3,  $E \rightarrow T$ , no node is created, since  $E.node$  is the same as  $T.node$ . Similarly, no node is created for production 4,  $T \rightarrow (E)$ . The value of  $T.node$  is the same as  $E.node$ , since parentheses are used only for grouping; they influence the structure of the parse tree and the syntax tree, but once their job is done, there is no further need to retain them in the syntax tree.

The last two T-productions have a single terminal on the right. We use the constructor *Leaf* to create a suitable node, which becomes the value of  $T.node$ .

Figure 5.11 shows the construction of a syntax tree for the input  $a - 4 + c$ . The nodes of the syntax tree are shown as records, with the *op* field first. Syntax-tree edges are now shown as solid lines. The underlying parse tree, which need not actually be constructed, is shown with dotted edges. The third type of line, shown dashed, represents the values of  $E.node$  and  $T.node$ ; each line points to the appropriate syntax-tree node.

At the bottom we see leaves for  $a$ , 4 and  $c$ , constructed by *Leaf*. We suppose that the lexical value *id.entry* points into the symbol table, and the lexical value *num.val* is the numerical value of a constant. These leaves, or pointers to them, become the value of  $T.node$  at the three parse-tree nodes labeled  $T$ , according to rules 5 and 6. Note that by rule 3, the pointer to the leaf for  $a$  is also the value of  $E.node$  for the leftmost  $E$  in the parse tree.

Rule 2 causes us to create a node with *op* equal to the minus sign and pointers to the first two leaves. Then, rule 1 produces the root node of the syntax tree by combining the node for  $-$  with the third leaf.

If the rules are evaluated during a postorder traversal of the parse tree, or with reductions during a bottom-up parse, then the sequence of steps shown in Fig. 5.12 ends with  $p$ , pointing to the root of the constructed syntax tree. •

With a grammar designed for top-down parsing, the same syntax trees are constructed, using the same sequence of steps, even though the structure of the parse trees differs significantly from that of syntax trees.

**Example 5.12:** The L-attributed definition in Fig. 5.13 performs the same translation as the S-attributed definition in Fig. 5.10. The attributes for the grammar symbols  $E$ ,  $T$ , **id**, and **num** are as discussed in Example 5.11.

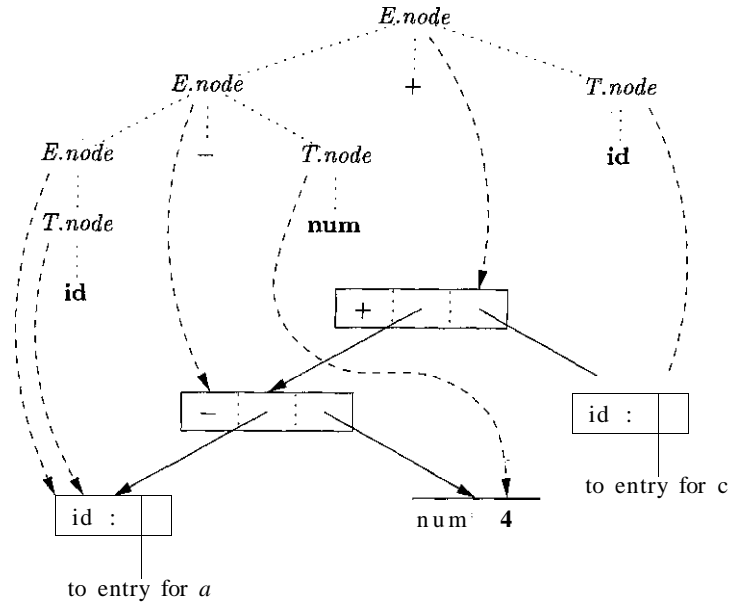
Figure 5.11: Syntax tree for  $a - 4 + c$ 

- 1)  $p_1 = \mathbf{new\ Leaf}(\mathbf{id}, \mathbf{entry-a});$
- 2)  $P_2 = \mathbf{new\ Leaf}(\mathbf{num}, 4);$
- 3)  $P_3 = \mathbf{new\ Node}('-', p_1, p_2);$
- 4)  $P_4 = \mathbf{new\ Leaf}(\mathbf{id}, \mathbf{entry-c});$
- 5)  $p_4 = \mathbf{new\ Node}('+', p_3, P_4);$

Figure 5.12: Steps in the construction of the syntax tree for  $a - 4 + c$ 

The rules for building syntax trees in this example are similar to the rules for the desk calculator in Example 5.3. In the desk-calculator example, a term  $x * y$  was evaluated by passing  $x$  as an inherited attribute, since  $x$  and  $*$   $y$  appeared in different portions of the parse tree. Here, the idea is to build a syntax tree for  $x + y$  by passing  $x$  as an inherited attribute, since  $x$  and  $+$   $y$  appear in different subtrees. Nonterminal  $E'$  is the counterpart of nonterminal  $T'$  in Example 5.3. Compare the dependency graph for  $a - 4 + c$  in Fig. 5.14 with that for  $3 * 5$  in Fig. 5.7.

Nonterminal  $E'$  has an inherited attribute  $inh$  and a synthesized attribute  $syn$ . Attribute  $E'.inh$  represents the partial syntax tree constructed so far. Specifically, it represents the root of the tree for the prefix of the input string that is to the left of the subtree for  $E'$ . At node 5 in the dependency graph in Fig. 5.14,  $E'.inh$  denotes the root of the partial syntax tree for the identifier  $a$ ; that is, the leaf for  $a$ . At node 6,  $E'.inh$  denotes the root for the partial syntax

PRODUCTION	SEMANTIC RULES
1) $E \rightarrow *T \quad E'$	$E.node = E'.syn$ $E'.inh = T.node$
2) $E' \rightarrow +TE[$	$E[.inh = \mathbf{new} \quad Node('+', E'.inh, T.node)$ $E'.syn = E[.syn$
3) $E' \rightarrow -TE[$	$E[.inh = \mathbf{new} \quad Node('-', E'.inh, T.node)$ $E'.syn = E[.syn$
4) $E' \rightarrow t \quad e$	$E'.syn = E'.inh$
5) $T \rightarrow (E)$	$T.node = E.node$
6) $T \rightarrow \mathbf{id}$	$T.node = \mathbf{new} \quad Leaf(id, id.entry)$
7) $T \rightarrow \mathbf{num}$	$T.node = \mathbf{new} \quad jLea/(num, num.val)$

Figure 5.13: Constructing syntax trees during top-down parsing

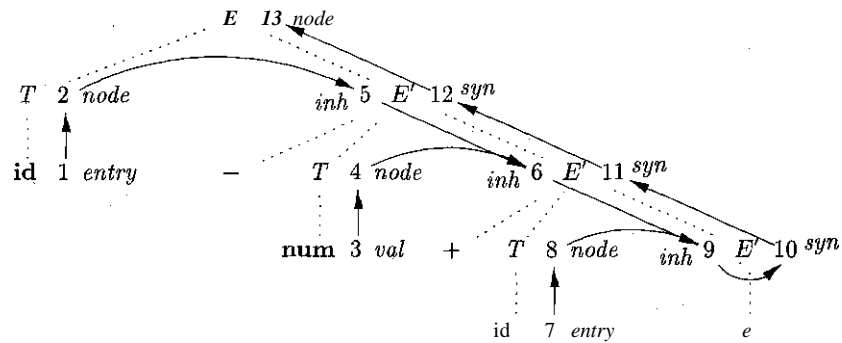

Figure 5.14: Dependency graph for  $a - 4 + c$ , with the SDD of Fig. 5.13

tree for the input  $a - 4$ . At node 9,  $E'.inh$  denotes the syntax tree for  $a - 4 + c$ .

Since there is no more input, at node 9,  $E'.inh$  points to the root of the entire syntax tree. The  $syn$  attributes pass this value back up the parse tree until it becomes the value of  $E.node$ . Specifically, the attribute value at node 10 is defined by the rule  $E'.syn = E'.inh$  associated with the production  $E' \rightarrow e$ . The attribute value at node 11 is defined by the rule  $E'.syn = E[.syn$  associated with production 2 in Fig. 5.13. Similar rules define the attribute values at nodes 12 and 13. •

### 5.3.2 The Structure of a Type

Inherited attributes are useful when the structure of the parse tree differs from the abstract syntax of the input; attributes can then be used to carry informa-



tion from one part of the parse tree to another. The next example shows how a mismatch in structure can be due to the design of the language, and not due to constraints imposed by the parsing method.

**Example 5.13:** In C, the type `int [2][3]` can be read as, "array of 2 arrays of 3 integers." The corresponding type expression `array(2, array(3, integer))` is represented by the tree in Fig. 5.15. The operator `array` takes two parameters, a number and a type. If types are represented by trees, then this operator returns a tree node labeled `array` with two children for a number and a type.

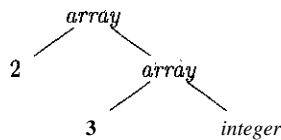

Figure 5.15: Type expression for `int[2][3]`

With the SDD in Fig. 5.16, nonterminal  $T$  generates either a basic type or an array type. Nonterminal  $B$  generates one of the basic types `int` and `float`.  $T$  generates a basic type when  $T$  derives  $BC$  and  $C$  derives  $e$ . Otherwise,  $C$  generates array components consisting of a sequence of integers, each integer surrounded by brackets.

PRODUCTION	SEMANTIC RULES
$T \rightarrow BC$	$T.t = C.t$ $C.b = B.t$
$B \rightarrow \bullet \text{ int}$	$B.t = \text{integer}$
$B \rightarrow \bullet \text{ float}$	$B.t = \text{float}$
$C \rightarrow \# [ \text{ num } ] Ci$	$C.t = \text{array}(\text{num.val}, C.t)$ $Cx.b = C.b$
$C \rightarrow + e$	$C.t = C.b$

Figure 5.16:  $T$  generates either a basic type or an array type

The nonterminals  $B$  and  $T$  have a synthesized attribute  $t$  representing a type. The nonterminal  $C$  has two attributes: an inherited attribute  $b$  and a synthesized attribute  $t$ . The inherited  $b$  attributes pass a basic type down the tree, and the synthesized  $t$  attributes accumulate the result.

An annotated parse tree for the input string `int [ 2 ] [ 3 ]` is shown in Fig. 5.17. The corresponding type expression in Fig. 5.15 is constructed by passing the type `integer` from  $B$ , down the chain of  $C$ 's through the inherited attributes  $b$ . The array type is synthesized up the chain of  $C$ 's through the attributes  $t$ .

In more detail, at the root for  $T \rightarrow BC$ , nonterminal  $C$  inherits the type from  $B$ , using the inherited attribute  $C.b$ . At the rightmost node for  $C$ , the

production is  $C \rightarrow e$ , so  $C.t$  equals  $C.6$ . The semantic rules for the production  $C \rightarrow [ \text{num} ] C \setminus$  form  $C.t$  by applying the operator *array* to the operands num.ua/ and  $C \setminus.t$ . •

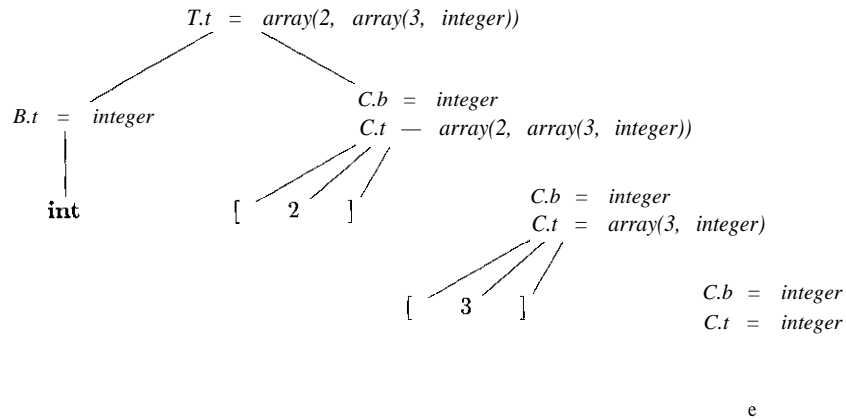

Figure 5.17: Syntax-directed translation of array types

### 5.3.3 Exercises for Section 5.3

**Exercise 5.3.1:** Below is a grammar for expressions involving operator 4- and integer or floating-point operands. Floating-point numbers are distinguished by having a decimal point.

$$E \rightarrow E + T \mid T$$

$$T \rightarrow \text{num} . \text{num} \mid \text{num}$$

- a) Give an SDD to determine the type of each term  $T$  and expression  $E$ .
- b) Extend your SDD of (a) to translate expressions into postfix notation. Use the unary operator **intToFloat** to turn an integer into an equivalent float.

**! Exercise 5.3.2 :** Give an SDD to translate infix expressions with + and \* into equivalent expressions without redundant parentheses. For example, since both operators associate from the left, and \* takes precedence over +,  $((a*(6+c))*(<i>i))$  translates into  $a * (b + c) * d$ .

**! Exercise 5.3.3:** Give an SDD to differentiate expressions such as  $x * (3 * x + x * x)$  involving the operators + and \*, the variable  $x$ , and constants. Assume that no simplification occurs, so that, for example,  $3 * x$  will be translated into  $3 * 1 + 0 * x$ .

## 5.4 Syntax-Directed Translation Schemes

Syntax-directed translation schemes are a complementary notation to syntax-directed definitions. All of the applications of syntax-directed definitions in Section 5.3 can be implemented using syntax-directed translation schemes.

From Section 2.3.5, a *syntax-directed translation scheme* (SDT) is a context-free grammar with program fragments embedded within production bodies. The program fragments are called *semantic actions* and can appear at any position within a production body. By convention, we place curly braces around actions; if braces are needed as grammar symbols, then we quote them.

Any SDT can be implemented by first building a parse tree and then performing the actions in a left-to-right depth-first order; that is, during a preorder traversal. An example appears in Section 5.4.3.

Typically, SDT's are implemented during parsing, without building a parse tree. In this section, we focus on the use of SDT's to implement two important classes of SDD's:

1. The underlying grammar is LR-parsable, and the SDD is S-attributed.
2. The underlying grammar is LL-parsable, and the SDD is L-attributed.

We shall see how, in both these cases, the semantic rules in an SDD can be converted into an SDT with actions that are executed at the right time. During parsing, an action in a production body is executed as soon as all the grammar symbols to the left of the action have been matched.

SDT's that can be implemented during parsing can be characterized by introducing distinct *marker nonterminals* in place of each embedded action; each marker  $M$  has only one production,  $M \rightarrow e$ . If the grammar with marker nonterminals can be parsed by a given method, then the SDT can be implemented during parsing.

### 5.4.1 Postfix Translation Schemes

By far the simplest SDD implementation occurs when we can parse the grammar bottom-up and the SDD is S-attributed. In that case, we can construct an SDT in which each action is placed at the end of the production and is executed along with the reduction of the body to the head of that production. SDT's with all actions at the right ends of the production bodies are called *postfix SDT's*.

Example 5.14: The postfix SDT in Fig. 5.18 implements the desk calculator SDD of Fig. 5.1, with one change: the action for the first production prints a value. The remaining actions are exact counterparts of the semantic rules. Since the underlying grammar is LR, and the SDD is S-attributed, these actions can be correctly performed along with the reduction steps of the parser. •

```

L      £ n      { print(?.vat)\ }
E  ->  Ei+T    { E.val = Ei.val+ T.vol] }
E  ->  T        { E.val = T.vaf; }
T  ->  Ti*F     { T.val=Ti.valx F.val] }
T  ->  F        { T.val = F.val; }
F  ->  (E)      { F.val = E.val; }
F      digit    { F.val = digit.lexval] }

```

Figure 5.18: Postfix SDT implementing the desk calculator

### 5.4.2 Parser-Stack Implementation of Postfix SDT's

Postfix SDT's can be implemented during LR parsing by executing the actions when reductions occur. The attribute(s) of each grammar symbol can be put on the stack in a place where they can be found during the reduction. The best plan is to place the attributes along with the grammar symbols (or the LR states that represent these symbols) in records on the stack itself.

In Fig. 5.19, the parser stack contains records with a field for a grammar symbol (or parser state) and, below it, a field for an attribute. The three grammar symbols  $X Y Z$  are on top of the stack; perhaps they are about to be reduced according to a production like  $A \rightarrow X Y Z$ . Here, we show  $X.x$  as the one attribute of  $X$ , and so on. In general, we can allow for more attributes, either by making the records large enough or by putting pointers to records on the stack. With small attributes, it may be simpler to make the records large enough, even if some fields go unused some of the time. However, if one or more attributes are of unbounded size — say, they are character strings — then it would be better to put a pointer to the attribute's value in the stack record and store the actual value in some larger, shared storage area that is not part of the stack.

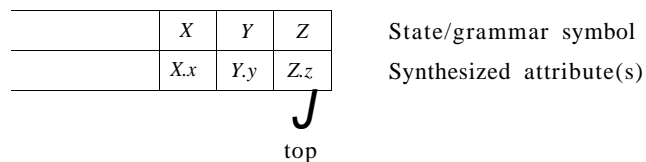

Figure 5.19: Parser stack with a field for synthesized attributes

If the attributes are all synthesized, and the actions occur at the ends of the productions, then we can compute the attributes for the head when we reduce the body to the head. If we reduce by a production such as  $A \rightarrow X Y Z$ , then we have all the attributes of  $X$ ,  $Y$ , and  $Z$  available, at known positions on the stack, as in Fig. 5.19. After the action,  $A$  and its attributes are at the top of the stack, in the position of the record for  $X$ .

Example 5.15 : Let us rewrite the actions of the desk-calculator SDT of Ex-

ample 5.14 so that they manipulate the parser stack explicitly. Such stack manipulation is usually done automatically by the parser.

PRODUCTION	ACTIONS
$L \rightarrow E n$	{ print ( <i>stack</i> [ <i>top</i> - 1]. <u>ua</u> ); <i>top</i> = <i>top</i> - 1; }
$E \rightarrow E_i + T$	{ <i>stack</i> [ <i>top</i> - 2]. <i>val</i> = <i>stack</i> [ <i>top</i> - 2]. <i>val</i> + <i>stack</i> [ <i>top</i> ]. <i>val</i> ; <i>top</i> = <i>top</i> - 2; }
$E \rightarrow T$	
$T \rightarrow T_i * F$	{ <i>stack</i> [ <i>top</i> - 2]. <u>ua</u> = <i>stack</i> [ <i>top</i> - 2]. <i>val</i> x <i>stack</i> [ <i>top</i> ]. <i>val</i> ; <i>top</i> = <i>top</i> - 2; }
$T \rightarrow F$	
$F \rightarrow \pm (E)$	{ <i>stack</i> [ <i>top</i> - 2]. <u>ua</u> = <i>stack</i> [ <i>top</i> - 1]. <i>val</i> ; <i>top</i> = <i>top</i> - 2; }
$F \rightarrow \bullet \text{ digit}$	

Figure 5.20: Implementing the desk calculator on a bottom-up parsing stack

Suppose that the stack is kept in an array of records called *stack*, with *top* a cursor to the top of the stack. Thus, *stack*[*top*] refers to the top record on the stack, *stack*[*top* - 1] to the record below that, and so on. Also, we assume that each record has a field called *val*, which holds the attribute of whatever grammar symbol is represented in that record. Thus, we may refer to the attribute *E.val* that appears at the third position on the stack as *stack*[*top* - 2].*val*. The entire SDT is shown in Fig. 5.20.

For instance, in the second production,  $E \rightarrow E_i + T$ , we go two positions below the top to get the value of  $E_i$ , and we find the value of  $T$  at the top. The resulting sum is placed where the head  $E$  will appear after the reduction, that is, two positions below the current top. The reason is that after the reduction, the three topmost stack symbols are replaced by one. After computing *E.val*, we pop two symbols off the top of the stack, so the record where we placed *E.val* will now be at the top of the stack.

In the third production,  $E \rightarrow T$ , no action is necessary, because the length of the stack does not change, and the value of *T.val* at the stack top will simply become the value of *E.val*. The same observation applies to the productions  $T \rightarrow F$  and  $F \rightarrow \text{digit}$ . Production  $F \rightarrow \pm (E)$  is slightly different. Although the value does not change, two positions are removed from the stack during the reduction, so the value has to move to the position after the reduction.

Note that we have omitted the steps that manipulate the first field of the stack records — the field that gives the LR state or otherwise represents the grammar symbol. If we are performing an LR parse, the parsing table tells us what the new state is every time we reduce; see Algorithm 4.44. Thus, we may

simply place that state in the record for the new top of stack. •

### 5.4.3 SDT's With Actions Inside Productions

An action may be placed at any position within the body of a production. It is performed immediately after all symbols to its left are processed. Thus, if we have a production  $B \rightarrow X \{a\} Y$ , the action  $a$  is done after we have recognized  $X$  (if  $X$  is a terminal) or all the terminals derived from  $X$  (if  $X$  is a nonterminal). More precisely,

- If the parse is bottom-up, then we perform action  $a$  as soon as this occurrence of  $X$  appears on the top of the parsing stack.
- If the parse is top-down, we perform  $a$  just before we attempt to expand this occurrence of  $Y$  (if  $Y$  a nonterminal) or check for  $Y$  on the input (if  $Y$  is a terminal).

SDT's that can be implemented during parsing include postfix SDT's and a class of SDT's considered in Section 5.5 that implements L-attributed definitions. Not all SDT's can be implemented during parsing, as we shall see in the next example.

**Example 5.16:** As an extreme example of a problematic SDT, suppose that we turn our desk-calculator running example into an SDT that prints the prefix form of an expression, rather than evaluating the expression. The productions and actions are shown in Fig. 5.21.

```

1)  $L \rightarrow E \ n$ 
2)  $E \rightarrow \{ \text{print}('+'); \} \ \#1 \ +T$ 
3)  $E \rightarrow T$ 
4)  $T \rightarrow \{ \text{print}('*'); \} \ ?i \ *E$ 
5)  $T \rightarrow \bullet F$ 
6)  $F \rightarrow (E)$ 
7)  $F \rightarrow \text{digit} \ \{ \text{print}(\text{digit.lexval}); \}$ 

```

Figure 5.21: Problematic SDT for infix-to-prefix translation during parsing

Unfortunately, it is impossible to implement this SDT during either top-down or bottom-up parsing, because the parser would have to perform critical actions, like printing instances of  $*$  or  $+$ , long before it knows whether these symbols will appear in its input.

Using marker nonterminals  $M_2$  and  $M_4$  for the actions in productions 2 and 4, respectively, on input 3, a shift-reduce parser (see Section 4.5.3) has conflicts between reducing by  $M_2 \rightarrow e$ , reducing by  $M_4 \rightarrow e$ , and shifting the digit. •

Any SDT can be implemented as follows:

1. Ignoring the actions, parse the input and produce a parse tree as a result.
2. Then, examine each interior node  $N$ , say one for production  $A \rightarrow a$ . Add additional children to  $N$  for the actions in  $a$ , so the children of  $N$  from left to right have exactly the symbols and actions of  $a$ .
3. Perform a preorder traversal (see Section 2.3.4) of the tree, and as soon as a node labeled by an action is visited, perform that action.

For instance, Fig. 5.22 shows the parse tree for expression  $3 * 5 + 4$  with actions inserted. If we visit the nodes in preorder, we get the prefix form of the expression:  $+ * 3 5 4$ .

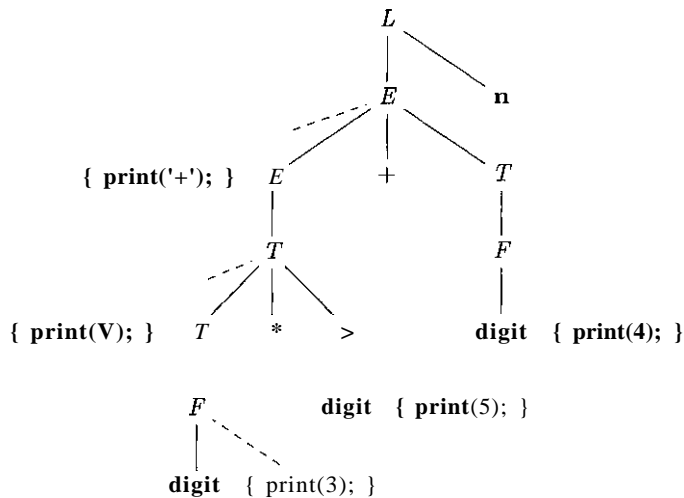

Figure 5.22: Parse tree with actions embedded

#### 5.4.4 Eliminating Left Recursion From SDT's

Since no grammar with left recursion can be parsed deterministically top-down, we examined left-recursion elimination in Section 4.3.3. When the grammar is part of an SDT, we also need to worry about how the actions are handled.

First, consider the simple case, in which the only thing we care about is the order in which the actions in an SDT are performed. For example, if each action simply prints a string, we care only about the order in which the strings are printed. In this case, the following principle can guide us:

- When transforming the grammar, treat the actions as if they were terminal symbols.

This principle is based on the idea that the grammar transformation preserves the order of the terminals in the generated string. The actions are therefore executed in the same order in any left-to-right parse, top-down or bottom-up.

The "trick" for eliminating left recursion is to take two productions

$$A \rightarrow \bullet Aa \mid (\beta$$

that generate strings consisting of a  $j\beta$  and any number of  $a$ 's, and replace them by productions that generate the same strings using a new nonterminal  $R$  (for "remainder") of the first production:

$$\begin{aligned} A &\rightarrow j\beta R \\ R &\rightarrow \bullet aR \mid \epsilon \end{aligned}$$

If  $\beta$  does not begin with  $A$ , then  $A$  no longer has a left-recursive production. In regular-definition terms, with both sets of productions,  $A$  is defined by  $\theta(a)^*$ . See Section 4.3.3 for the handling of situations where  $A$  has more recursive or nonrecursive productions.

**Example 5.17:** Consider the following E-productions from an SDT for translating infix expressions into postfix notation:

$$\begin{aligned} E &\rightarrow E i + T \quad \{ \text{print}(' '); \} \\ E &\rightarrow T \end{aligned}$$

If we apply the standard transformation to  $E$ , the remainder of the left-recursive production is

$$a = + T \{ \text{print}('r '); \}$$

and the body of the other production is  $T$ . If we introduce  $R$  for the remainder of  $E$ , we get the set of productions:

$$\begin{aligned} E &\rightarrow T R \\ R &\rightarrow + T \{ \text{print}('h '); \} R \\ R &\rightarrow \bullet \epsilon \end{aligned}$$

•

When the actions of an SDD compute attributes rather than merely printing output, we must be more careful about how we eliminate left recursion from a grammar. However, if the SDD is S-attributed, then we can always construct an SDT by placing attribute-computing actions at appropriate positions in the new productions.

We shall give a general schema for the case of a single recursive production, a single nonrecursive production, and a single attribute of the left-recursive nonterminal; the generalization to many productions of each type is not hard, but is notationally cumbersome. Suppose that the two productions are



$$\begin{array}{l} A \quad A.Y \quad \{A.a = g(A.a, Y.y)\} \\ A \quad -> \quad X \quad \{A.a = f(X.x)\} \end{array}$$

Here,  $X.a$  is the synthesized attribute of left-recursive nonterminal  $A$ , and  $X$  and  $Y$  are single grammar symbols with synthesized attributes  $X.x$  and  $Y.y$ , respectively. These could represent a string of several grammar symbols, each with its own attribute(s), since the schema has an arbitrary function  $g$  computing  $A.a$  in the recursive production and an arbitrary function  $f$  computing  $A.a$  in the second production. In each case,  $f$  and  $g$  take as arguments whatever attributes they are allowed to access if the SDD is S-attributed.

We want to turn the underlying grammar into

$$\begin{array}{l} A \quad -\gg \quad X R \\ R \quad \quad YR \quad | \quad e \end{array}$$

Figure 5.23 suggests what the SDT on the new grammar must do. In (a) we see the effect of the postfix SDT on the original grammar. We apply  $f$  once, corresponding to the use of production  $A \rightarrow X$ , and then apply  $g$  as many times as we use the production  $A \rightarrow AY$ . Since  $R$  generates a "remainder" of  $Y$ 's, its translation depends on the string to its left, a string of the form  $XY \cdot \cdot \cdot Y$ . Each use of the production  $R \rightarrow YR$  results in an application of  $g$ . For  $R$ , we use an inherited attribute  $R.i$  to accumulate the result of successively applying  $g$ , starting with the value of  $A.a$ .

$$\begin{array}{l} A.a = g(g(f(X.x), Y_1.y), Y_2.y) \quad A \\ \\ A.a = g(f(X.x), Y_1.y) \quad Y_1 \quad X \quad R.i = f(X.x) \\ \\ A.a = f(X.x) \quad \mathbf{Yi} \quad \mathbf{Yi} \quad R.i = g(f(X.x), Y_1.y) \\ \\ X \quad \quad \quad Y_1 \quad ' \quad R.i = g(g(f(X.x), Y_1.y), Y_2.y) \\ \\ \text{(a)} \quad \quad \quad \text{(b)} \end{array}$$

Figure 5.23: Eliminating left recursion from a postfix SDT

In addition,  $R$  has a synthesized attribute  $R.s$ , not shown in Fig. 5.23. This attribute is first computed when  $R$  ends its generation of  $Y$  symbols, as signaled by the use of production  $R \rightarrow e$ .  $R.s$  is then copied up the tree, so it can become the value of  $A.a$  for the entire expression  $XY \cdot \cdot \cdot Y$ . The case where  $A$  generates  $XY$  is shown in Fig. 5.23, and we see that the value of  $A.a$  at the root of (a) has two uses of  $g$ . So does  $R.i$  at the bottom of tree (b), and it is this value of  $R.s$  that gets copied up that tree.

To accomplish this translation, we use the following SDT:

$$\begin{array}{lcl}
 A & \rightarrow & X \{R.i = f(X.x)\} R \{A.a = R.s\} \\
 R & \rightarrow & Y \{R.i = g(R.i,Y.y)\} Ri \{R.s = Ri.s\} \\
 R & \rightarrow & e \{R.s = R.i\}
 \end{array}$$

Notice that the inherited attribute  $R.i$  is evaluated immediately before a use of  $R$  in the body, while the synthesized attributes  $A.a$  and  $R.s$  are evaluated at the ends of the productions. Thus, whatever values are needed to compute these attributes will be available from what has been computed to the left.

### 5.4.5 SDT's for L-Attributed Definitions

In Section 5.4.1, we converted S-attributed SDD's into postfix SDT's, with actions at the right ends of productions. As long as the underlying grammar is LR, postfix SDT's can be parsed and translated bottom-up.

Now, we consider the more general case of an L-attributed SDD. We shall assume that the underlying grammar can be parsed top-down, for if not it is frequently impossible to perform the translation in connection with either an LL or an LR parser. With any grammar, the technique below can be implemented by attaching actions to a parse tree and executing them during preorder traversal of the tree.

The rules for turning an L-attributed SDD into an SDT are as follows:

1. Embed the action that computes the inherited attributes for a nonterminal  $A$  immediately before that occurrence of  $A$  in the body of the production. If several inherited attributes for  $A$  depend on one another in an acyclic fashion, order the evaluation of attributes so that those needed first are computed first.
2. Place the actions that compute a synthesized attribute for the head of a production at the end of the body of that production.

We shall illustrate these principles with two extended examples. The first involves typesetting. It illustrates how the techniques of compiling can be used in language processing for applications other than what we normally think of as programming languages. The second example is about the generation of intermediate code for a typical programming-language construct: a form of while-statement.

**Example 5.18:** This example is motivated by languages for typesetting mathematical formulas. Eqn is an early example of such a language; ideas from Eqn are still found in the T<sup>A</sup>X typesetting system, which was used to produce this book.

We shall concentrate on only the capability to define subscripts, subscripts of subscripts, and so on, ignoring superscripts, built-up fractions, and all other mathematical features. In the Eqn language, one writes a sub  $i$  sub  $j$  to set the expression  $a_{i,j}$ . A simple grammar for *boxes* (elements of text bounded by a rectangle) is

$$B \wedge B_1 B_2 \setminus B_1 \quad \text{sub} \quad B_2 \setminus (B_1) \quad \text{text}$$

Corresponding to these four productions, a box can be either

1. Two boxes, juxtaposed, with the first,  $B_1$ , to the left of the other,  $B_2$ .
2. A box and a subscript box. The second box appears in a smaller size, lower, and to the right of the first box.
3. A parenthesized box, for grouping of boxes and subscripts. Eqn and IgX both use curly braces for grouping, but we shall use ordinary, round parentheses to avoid confusion with the braces that surround actions in SDT's.
4. A text string, that is, any string of characters.

This grammar is ambiguous, but we can still use it to parse bottom-up if we make subscripting and juxtaposition right associative, with `sub` taking precedence over juxtaposition.

Expressions will be typeset by constructing larger boxes out of smaller ones. In Fig. 5.24, the boxes for  $E_1$  and `.height` are about to be juxtaposed to form the box for  $E_1.height$ . The left box for  $E_1$  is itself constructed from the box for  $E$  and the subscript 1. The subscript 1 is handled by shrinking its box by about 30%, lowering it, and placing it after the box for  $E$ . Although we shall treat `.height` as a text string, the rectangles within its box show how it can be constructed from boxes for the individual letters.



Figure 5.24: Constructing larger boxes from smaller ones

In this example, we concentrate on the vertical geometry of boxes only. The horizontal geometry — the widths of boxes — is also interesting, especially when different characters have different widths. It may not be readily apparent, but each of the distinct characters in Fig. 5.24 has a different width.

The values associated with the vertical geometry of boxes are as follows:

- a) The *point size* is used to set text within a box. We shall assume that characters not in subscripts are set in 10 point type, the size of type in this book. Further, we assume that if a box has point size  $p$ , then its subscript box has the smaller point size  $0.7p$ . Inherited attribute  $B.ps$  will represent the point size of block  $B$ . This attribute must be inherited, because the context determines by how much a given box needs to be shrunk, due to the number of levels of subscripting.

- b) Each box has a *baseline*, which is a vertical position that corresponds to the bottoms of lines of text, not counting any letters, like "g" that extend below the normal baseline. In Fig. 5.24, the dotted line represents the baseline for the boxes *E*, *.height*, and the entire expression. The baseline for the box containing the subscript 1 is adjusted to lower the subscript.
- c) A box has a *height*, which is the distance from the top of the box to the baseline. Synthesized attribute *B.ht* gives the height of box *B*.
- d) A box has a *depth*, which is the distance from the baseline to the bottom of the box. Synthesized attribute *B.dp* gives the depth of box *B*.

The SDD in Fig. 5.25 gives rules for computing point sizes, heights, and depths. Production 1 is used to assign *B.ps* the initial value 10.

PRODUCTION	SEMANTIC RULES
1) $S \rightarrow B$	$B.ps = 10$
2) $B \rightarrow y B_1 B_2$	$B_i.ps = B.ps$ $B.ps = B.ps$ $B.ht = \max(B_1.ht, B_2.ht)$ $B.dp = \max(B_1.dp, B_2.dp)$
3) $B \rightarrow y B_i \text{ sub } B_s$	$B_i.ps = B.ps$ $B_s.ps = 0.7 \times B.ps$ $B.ht = \max(B_i.ht, B_s.ht - 0.25 \times B.ps)$ $B.dp = \max(B_i.dp, B_s.dp + 0.25 \times B.ps)$
4) $B \rightarrow ( B_i )$	$B_i.ps = B.ps$ $B.ht = B_i.ht$ $B.dp = B_i.dp$
5) $B \rightarrow \text{text}$	$B.ht = \text{getHt}(B.ps, \text{text}, \text{lexval})$ $B.dp = \text{getDp}(B.ps, \text{text}, \text{lexval})$

Figure 5.25: SDD for typesetting boxes

Production 2 handles juxtaposition. Point sizes are copied down the parse tree; that is, two sub-boxes of a box inherit the same point size from the larger box. Heights and depths are computed up the tree by taking the maximum. That is, the height of the larger box is the maximum of the heights of its two components, and similarly for the depth.

Production 3 handles subscripting and is the most subtle. In this greatly simplified example, we assume that the point size of a subscripted box is 70% of the point size of its parent. Reality is much more complex, since subscripts cannot shrink indefinitely; in practice, after a few levels, the sizes of subscripts

shrink hardly at all. Further, we assume that the baseline of a subscript box drops by 25% of the parent's point size; again, reality is more complex.

Production 4 copies attributes appropriately when parentheses are used. Finally, production 5 handles the leaves that represent text boxes. In this matter too, the true situation is complicated, so we merely show two unspecified functions *getHt* and *getDp* that examine tables created with each font to determine the maximum height and maximum depth of any characters in the text string. The string itself is presumed to be provided as the attribute *lexval* of terminal text.

Our last task is to turn this SDD into an SDT, following the rules for an L-attributed SDD, which Fig. 5.25 is. The appropriate SDT is shown in Fig. 5.26. For readability, since production bodies become long, we split them across lines and line up the actions. Production bodies therefore consist of the contents of all lines up to the head of the next production. •

	PRODUCTION	ACTIONS
1)	$S$ $B$	{ $B.ps = 10;$ }
2)	$B$ $Bi$ $B_1$	{ $Bi.ps = B.ps;$ } { $B_1.ps = B.ps;$ } { $B.ht = \max(Bi.ht, B_1.ht);$ $B.dp = \max(Bi.dp, B_1.dp);$ }
3)	$B$ $Bi$ sub $B_1$	{ $Bi.ps = B.ps;$ } { $B_1.ps = 0.7 \times B.ps;$ } { $B.ht = \max(Bi.ht, B_1.ht - 0.25 \times B.ps);$ $B.dp = \max(B_1.dp, B_1.dp + 0.25 \times B.ps);$
4)	$B \rightarrow ($ $Bi)$	{ $Bi.ps = B.ps;$ } { $B.ht = Bi.ht;$ $B.dp = Bi.dp;$ }
5)	$B$ text	{ $BM = getHt (B.ps, text.lexval);$ $B.dp = getDp (B.ps, text.lexval);$ }

Figure 5.26: SDT for typesetting boxes

Our next example concentrates on a simple while-statement and the generation of intermediate code for this type of statement. Intermediate code will be treated as a string-valued attribute. Later, we shall explore techniques that involve the writing of pieces of a string-valued attribute as we parse, thus avoiding the copying of long strings to build even longer strings. The technique was introduced in Example 5.17, where we generated the postfix form of an infix

expression "on-the-fly," rather than computing it as an attribute. However, in our first formulation, we create a string-valued attribute by concatenation.

Example 5.19: For this example, we only need one production:

$$S \rightarrow \text{while} ( C ) \mathbf{S}i$$

Here,  $S$  is the nonterminal that generates all kinds of statements, presumably including if-statements, assignment statements, and others. In this example,  $C$  stands for a conditional expression — a boolean expression that evaluates to true or false.

In this flow-of-control example, the only things we ever generate are labels. All the other intermediate-code instructions are assumed to be generated by parts of the SDT that are not shown. Specifically, we generate explicit instructions of the form label  $L$ , where  $L$  is an identifier, to indicate that  $L$  is the label of the instruction that follows. We assume that the intermediate code is like that introduced in Section 2.8.4.

The meaning of our while-statement is that the conditional  $C$  is evaluated. If it is true, control goes to the beginning of the code for  $\mathbf{S}i$ . If false, then control goes to the code that follows the while-statement's code. The code for  $\mathbf{S}i$  must be designed to jump to the beginning of the code for the while-statement when finished; the jump to the beginning of the code that evaluates  $C$  is not shown in Fig. 5.27.

We use the following attributes to generate the proper intermediate code:

1. The inherited attribute  $S.next$  labels the beginning of the code that must be executed after  $\mathbf{S}$  is finished.
2. The synthesized attribute  $S.code$  is the sequence of intermediate-code steps that implements a statement  $\mathbf{S}$  and ends with a jump to  $S.next$ .
3. The inherited attribute  $C.true$  labels the beginning of the code that must be executed if  $C$  is true.
4. The inherited attribute  $C.false$  labels the beginning of the code that must be executed if  $C$  is false.
5. The synthesized attribute  $C.code$  is the sequence of intermediate-code steps that implements the condition  $C$  and jumps either to  $C.true$  or to  $C.false$ , depending on whether  $C$  is true or false.

The SDD that computes these attributes for the while-statement is shown in Fig. 5.27. A number of points merit explanation:

- The function *new* generates new labels.
- The variables  $L1$  and  $L2$  hold labels that we need in the code.  $L1$  is the beginning of the code for the while-statement, and we need to arrange

```

S -> while (C)Si      Ll = newQ;
                      L2 = newQ;
                      S±next = LI;
                      C.false = S.next;
                      C.true = 1/2;
                      S.code = label || LI \\ C.code || label || L2 || S.code

```

Figure 5.27: SDD for while-statements

that  $S_i$  jumps there after it finishes. That is why we set  $S_i.next$  to  $LI$ .  $L2$  is the beginning of the code for  $S_i$ , and it becomes the value of  $C.true$ , because we branch there when  $C$  is true.

- Notice that  $C.false$  is set to  $S.next$ , because when the condition is false, we execute whatever code must follow the code for  $S$ .
- We use `||` as the symbol for concatenation of intermediate-code fragments. The value of  $S.code$  thus begins with the label  $LI$ , then the code for condition  $C$ , another label  $L2$ , and the code for  $S_i$ .

This SDD is L-attributed. When we convert it into an SDT, the only remaining issue is how to handle the labels  $LI$  and  $L2$ , which are variables, and not attributes. If we treat actions as dummy nonterminals, then such variables can be treated as the synthesized attributes of dummy nonterminals. Since  $LI$  and  $L2$  do not depend on any other attributes, they can be assigned to the first action in the production. The resulting SDT with embedded actions that implements this L-attributed definition is shown in Fig. 5.28. •

```

S -> while ( { LI = newQ; L2 = newQ; C.false = S.next; C.true = L2; }
             C) { Si.next^LI; }

Si          { S.code = label || LI || C.code || label || L2 || Si.code; }

```

Figure 5.28: SDT for while-statements

## 5.4.6 Exercises for Section 5.4

**Exercise 5.4.1:** We mentioned in Section 5.4.2 that it is possible to deduce, from the LR state on the parsing stack, what grammar symbol is represented by the state. How would we discover this information?

**Exercise 5.4.2:** Rewrite the following SDT:

```

A    A {a} B / A B {b} | 0
B -> B {c} A | B A {d} | 1

```

so that the underlying grammar becomes non-left-recursive. Here,  $a$ ,  $b$ ,  $c$ , and  $d$  are actions, and 0 and 1 are terminals.

! **Exercise 5.4.3:** The following SDT computes the value of a string of 0's and 1's interpreted as a positive, binary integer.

$$\begin{array}{l} B \rightarrow Br\ 0\ \{B.val = 2 \times B_i.val\} \\ \quad / \quad B_i\ 1\ \{B.val = 2 \times B_i.val + 1\} \\ \quad j \quad 1\ \{B.val = 1\} \end{array}$$

Rewrite this SDT so the underlying grammar is not left recursive, and yet the same value of  $B.val$  is computed for the entire input string.

! **Exercise 5.4.4:** Write L-attributed SDD's analogous to that of Example 5.19 for the following productions, each of which represents a familiar flow-of-control construct, as in the programming language C. You may need to generate a three-address statement to jump to a particular label  $L$ , in which case you should generate `goto L`.

- $S \rightarrow \text{if} ( C )\ S_1\ \text{else}\ S_2$
- $S \rightarrow \text{do}\ S_1\ \text{while} ( C )$
- $S \rightarrow \{ L \};\ L \rightarrow L S \mid e$

Note that any statement in the list can have a jump from its middle to the next **Statement**, so it is not sufficient simply to generate code for each statement in order.

**Exercise 5.4.5:** Convert each of your SDD's from Exercise 5.4.4 to an SDT in the manner of Example 5.19.

**Exercise 5.4.6:** Modify the SDD of Fig. 5.25 to include a synthesized attribute  $B.le$ , the length of a box. The length of the concatenation of two boxes is the sum of the lengths of each. Then add your new rules to the proper positions in the SDT of Fig. 5.26

**Exercise 5.4.7:** Modify the SDD of Fig. 5.25 to include superscripts denoted by operator `sup` between boxes. If box  $B_i$  is a superscript of box  $B_j$ , then position the baseline of  $B_i$  0.6 times the point size of  $B_j$  above the baseline of  $B_j$ . Add the new production and rules to the SDT of Fig. 5.26.

## 5.5 Implementing L-Attributed SDD's

Since many translation applications can be addressed using L-attributed definitions, we shall consider their implementation in more detail in this section. The following methods do translation by traversing a parse tree:



1. *Build the parse tree and annotate.* This method works for any noncircular SDD whatsoever. We introduced annotated parse trees in Section 5.1.2.
2. *Build the parse tree, add actions, and execute the actions in preorder.* This approach works for any L-attributed definition. We discussed how to turn an L-attributed SDD into an SDT in Section 5.4.5; in particular, we discussed how to embed actions into productions based on the semantic rules of such an SDD.

In this section, we discuss the following methods for translation during parsing:

3. *Use a recursive-descent parser with one function for each nonterminal.* The function for nonterminal  $A$  receives the inherited attributes of  $A$  as arguments and returns the synthesized attributes of  $A$ .
4. *Generate code on the fly,* using a recursive-descent parser.
5. *Implement an SDT in conjunction with an LL-parser.* The attributes are kept on the parsing stack, and the rules fetch the needed attributes from known locations on the stack.
6. *Implement an SDT in conjunction with an LR-parser.* This method may be surprising, since the SDT for an L-attributed SDD typically has actions in the middle of productions, and we cannot be sure during an LR parse that we are even in that production until its entire body has been constructed. We shall see, however, that if the underlying grammar is LL, we can always handle both the parsing and translation bottom-up.

### 5.5.1 Translation During Recursive-Descent Parsing

A recursive-descent parser has a function  $A$  for each nonterminal  $A$ , as discussed in Section 4.4.1. We can extend the parser into a translator as follows:

- a) The arguments of function  $A$  are the inherited attributes of nonterminal  $A$ .
- b) The return-value of function  $A$  is the collection of synthesized attributes of nonterminal  $A$ .

In the body of function  $A$ , we need to both parse and handle attributes:

1. Decide upon the production used to expand  $A$ .
2. Check that each terminal appears on the input when it is required. We shall assume that no backtracking is needed, but the extension to recursive-descent parsing with backtracking can be done by restoring the input position upon failure, as discussed in Section 4.4.1.

3. Preserve, in local variables, the values of all attributes needed to compute inherited attributes for nonterminals in the body or synthesized attributes for the head nonterminal.
4. Call functions corresponding to nonterminals in the body of the selected production, providing them with the proper arguments. Since the underlying SDD is L-attributed, we have already computed these attributes and stored them in local variables.

**Example 5.20** : Let us consider the SDD and SDT of Example 5.19 for while-statements. A pseudocode rendition of the relevant parts of the function *S* appears in Fig. 5.29.

```

string S(label next) {
    string Scode, Ccode; /* local variables holding code fragments */
    label LI, L2; /* the local labels */
    if ( current input == token while ) {
        advance input;
        check '(' is next on the input, and advance;
        LI = new();
        L2 = new();
        Ccode = C(next, L2);
        check ')' is next on the input, and advance;
        Scode = S(LI);
        return C'label' || LI || Ccode || "label" || L2 || Scode;
    }
    else /* other statement types */
}

```

Figure 5.29: Implementing while-statements with a recursive-descent parser

We show *S* as storing and returning long strings. In practice, it would be far more efficient for functions like *S* and *C* to return pointers to records that represent these strings. Then, the return-statement in function *S* would not physically concatenate the components shown, but rather would construct a record, or perhaps tree of records, expressing the concatenation of the strings represented by *Scode* and *Ccode*, the labels LI and L2, and the two occurrences of the literal string "label". •

**Example 5.21**: Now, let us take up the SDT of Fig. 5.26 for typesetting boxes. First, we address parsing, since the underlying grammar in Fig. 5.26 is ambiguous. The following transformed grammar makes juxtaposition and subscripting right associative, with **sub** taking precedence over juxtaposition:

$$\begin{array}{l}
 S \quad \rightarrow \quad B \\
 B \quad \rightarrow \quad T B_i \mid T \\
 T \quad \rightarrow \quad F \mathbf{sub} T_i \mid F \\
 F \quad \rightarrow \quad ( B ) \mid \text{text}
 \end{array}$$

The two new nonterminals,  $T$  and  $F$ , are motivated by terms and factors in expressions. Here, a "factor," generated by  $F$ , is either a parenthesized box or a text string. A "term," generated by  $T$ , is a "factor" with a sequence of subscripts, and a box generated by  $B$  is a sequence of juxtaposed "terms."

The attributes of  $B$  carry over to  $T$  and  $F$ , since the new nonterminals also denote boxes; they were introduced simply to aid parsing. Thus, both  $T$  and  $F$  have an inherited attribute  $ps$  and synthesized attributes  $ht$  and  $dp$ , with semantic actions that can be adapted from the SDT in Fig. 5.26.

The grammar is not yet ready for top-down parsing, since the productions for  $B$  and  $T$  have common prefixes. Consider  $T$ , for instance. A top-down parser cannot choose between the two productions for  $T$  by looking one symbol ahead in the input. Fortunately, we can use a form of left-factoring, discussed in Section 4.3.4, to make the grammar ready. With SDT's, the notion of common prefix applies to actions as well. Both productions for  $T$  begin with the nonterminal  $F$  inheriting attribute  $ps$  from  $T$ .

The pseudocode in Fig. 5.30 for  $T(ps)$  folds in the code for  $F(ps)$ . After left-factoring is applied to  $T \rightarrow F \mathbf{sub} T_i \mid F$ , there is only one call to  $F$ ; the pseudocode shows the result of substituting the code for  $F$  in place of this call.

The function  $T$  will be called as  $T(10.0)$  by the function for  $B$ , which we do not show. It returns a pair consisting of the height and depth of the box generated by nonterminal  $T$ ; in practice, it would return a record containing the height and depth.

Function  $T$  begins by checking for a left parenthesis, in which case it must have the production  $F \rightarrow (B)$  to work with. It saves whatever the  $B$  inside the parentheses returns, but if that  $B$  is not followed by a right parenthesis, then there is a syntax error, which must be handled in a manner not shown.

Otherwise, if the current input is text, then the function  $T$  uses  $getHt$  and  $getDp$  to determine the height and depth of this text.

$T$  then decides whether the next box is a subscript and adjusts the point size, if so. We use the actions associated with the production  $B \rightarrow \bullet B \mathbf{sub} B$  in Fig. 5.26 for the height and depth of the larger box. Otherwise, we simply return what  $F$  would have returned:  $(hl,d)$ . •

## 5.5.2 On-The-Fly Code Generation

The construction of long strings of code that are attribute values, as in Example 5.20, is undesirable for several reasons, including the time it could take to copy or move long strings. In common cases such as our running code-generation example, we can instead incrementally generate pieces of the code into an array or output file by executing actions in an SDT. The elements we need to make this technique work are:

```

(float, float) r(float ps) {
  float hi, h2, dl, d2; /* locals to hold heights and depths */
  /* start code for F(ps) */
  if ( current input == '(' ) {
    advance input;
    (hl,dl) = B(ps);
    if (current input != ')') syntax error: expected ')';
    advance input;
  }
  else if ( current input == text ) {
    let lexical value text.lexval be t;
    advance input;
    hi = getHt(ps, t);
    dl = getDp(ps, t);
  }
  else syntax error: expected text or '(';
  /* end code for F(ps) */
  if ( current input == sub ) {
    advance input;
    (h2,d2) = T(0.7*ps);
    return (max(/il, h2 - 0.25 * ps), max(dl, d2 + 0.25 * ps));
  }
  return (hi, dl);
}

```

Figure 5.30: Recursive-descent typesetting of boxes

1. There is, for one or more nonterminals, a *main* attribute. For convenience, we shall assume that the main attributes are all string valued. In Example 5.20, the attributes *S.code* and *C.code* are main attributes; the other attributes are not.
2. The main attributes are synthesized.
3. The rules that evaluate the main attribute (s) ensure that
  - (a) The main attribute is the concatenation of main attributes of nonterminals appearing in the body of the production involved, perhaps with other elements that are not main attributes, such as the string **label** or the values of labels *L1* and *L2*.
  - (b) The main attributes of nonterminals appear in the rule in the same order as the nonterminals themselves appear in the production body.

As a consequence of the above conditions, the main attribute can be constructed by emitting the non-main-attribute elements of the concatenation. We can rely

## The Type of Main Attributes

Our simplifying assumption that main attributes are of string type is really too restrictive. The true requirement is that the type of all the main attributes must have values that can be constructed by concatenation of elements. For instance, a list of objects of any type would be appropriate, as long as we represent these lists in a way that allows elements to be efficiently appended to the end of the list. Thus, if the purpose of the main attribute is to represent a sequence of intermediate-code statements, we could produce the intermediate code by writing statements to the end of an array of objects. Of course the requirements stated in Section 5.5.2 still apply to lists; for example, main attributes must be assembled from other main attributes by concatenation in order.

on the recursive calls to the functions for the nonterminals in a production body to emit the value of their main attribute incrementally.

**Example 5.22:** We can modify the function of Fig. 5.29 to emit elements of the main translation *S.code* instead of saving them for concatenation into a return value of *S.code*. The revised function *S* appears in Fig. 5.31.

```

void  $\mathfrak{f}$ (label next) {
    label LI, L2; /* the local labels */
    if ( current input == token while ) {
        advance input;
        check '(' is next on the input, and advance;
        LI = newQ;
        L2 = newQ;
        print("la.bel",LI);
        C(next, L2);
        check ')' is next on the input, and advance;
        print(" label ",L2);
        S(LI);
    }
    else /* other statement types */
}

```

Figure 5.31: On-the-fly recursive-descent code generation for while-statements

In Fig. 5.31, *S* and *C* now have no return value, since their only synthesized attributes are produced by printing. Further, the position of the print statements is significant. The order in which output is printed is: first label *LI*, then the code for *C* (which is the same as the value of *Ccode* in Fig. 5.29), then

label  $L2$ , and finally the code from the recursive call to  $S$  (which is the same as  $Score$  in Fig. 5.29). Thus, the code printed by this call to  $S$  is exactly the same as the value of  $Score$  that is returned in Fig. 5.29). •

Incidentally, we can make the same change to the underlying SDT: turn the construction of a main attribute into actions that emit the elements of that attribute. In Fig. 5.32 we see the SDT of Fig. 5.28 revised to generate code on the fly.

```

S  →  while (  {LI = newQ; L2 = newQ; C.false = S.next;
                C.true = L2; print("label", LI); }
C )      {  Si.next = LI; print("label", L2); }
Si

```

Figure 5.32: SDT for on-the-fly code generation for while statements

### 5.5.3 L-Attributed SDD's and LL Parsing

Suppose that an L-attributed SDD is based on an LL-grammar and that we have converted it to an SDT with actions embedded in the productions, as described in Section 5.4.5. We can then perform the translation during LL parsing by extending the parser stack to hold actions and certain data items needed for attribute evaluation. Typically, the data items are copies of attributes.

In addition to records representing terminals and nonterminals, the parser stack will hold *action-records* representing actions to be executed and *synthesize-records* to hold the synthesized attributes for nonterminals. We use the following two principles to manage attributes on the stack:

- The inherited attributes of a nonterminal  $A$  are placed in the stack record that represents that nonterminal. The code to evaluate these attributes will usually be represented by an action-record immediately above the stack record for  $A$ ; in fact, the conversion of L-attributed SDD's to SDT's ensures that the action-record will be immediately above  $A$ .
- The synthesized attributes for a nonterminal  $A$  are placed in a separate synthesize-record that is immediately below the record for  $A$  on the stack.

This strategy places records of several types on the parsing stack, trusting that these variant record types can be managed properly as subclasses of a "stack-record" class. In practice, we might combine several records into one, but the ideas are perhaps best explained by separating data used for different purposes into different records.

Action-records contain pointers to code to be executed. Actions may also appear in synthesize-records; these actions typically place copies of the synthesized attribute(s) in other records further down the stack, where the value of

that attribute will be needed after the synthesize-record and its attributes are popped off the stack.

Let us take a brief look at LL parsing to see the need to make temporary copies of attributes. From Section 4.4.4, a table-driven LL parser mimics a leftmost derivation. If  $w$  is the input that has been matched so far, then the stack holds a sequence of grammar symbols  $a$  such that  $S \Rightarrow wa$ , where  $S$  is the start symbol. When the parser expands by a production  $A \rightarrow B C$ , it replaces  $A$  on top of the stack by  $B C$ .

Suppose nonterminal  $C$  has an inherited attribute  $C.i$ . With  $AB C$ , the inherited attribute  $C.i$  may depend not only on the inherited attributes of  $A$ , but on all the attributes of  $B$ . Thus, we may need to process  $B$  completely before  $C.i$  can be evaluated. We therefore save temporary copies of all the attributes needed to evaluate  $C.i$  in the action-record that evaluates  $C.i$ . Otherwise, when the parser replaces  $A$  on top of the stack by  $B C$ , the inherited attributes of  $A$  will have disappeared, along with its stack record.

Since the underlying SDD is L-attributed, we can be sure that the values of the inherited attributes of  $A$  are available when  $A$  rises to the top of the stack. The values will therefore be available in time to be copied into the action-record that evaluates the inherited attributes of  $C$ . Furthermore, space for the synthesized attributes of  $A$  is not a problem, since the space is in the synthesize-record for  $A$ , which remains on the stack, below  $B$  and  $C$ , when the parser expands by  $A \rightarrow B C$ .

As  $B$  is processed, we can perform actions (through a record just above  $B$  on the stack) that copy its inherited attributes for use by  $C$ , as needed, and after  $B$  is processed, the synthesize-record for  $B$  can copy its synthesized attributes for use by  $C$ , if needed. Likewise, synthesized attributes of  $A$  may need temporaries to help compute their value, and these can be copied to the synthesize-record for  $A$  as  $B$  and then  $C$  are processed. The principle that makes all this copying of attributes work is:

- All copying takes place among the records that are created during one expansion of one nonterminal. Thus, each of these records knows how far below it on the stack each other record is, and can write values into the records below safely.

The next example illustrates the implementation of inherited attributes during LL parsing by diligently copying attribute values. Shortcuts or optimizations are possible, particularly with copy rules, which simply copy the value of one attribute into another. Shortcuts are deferred until Example 5.24, which also illustrates synthesize-records.

Example 5.23: This example implements the the SDT of Fig. 5.32, which generates code on the fly for the while-production. This SDT does not have synthesized attributes, except for dummy attributes that represent labels.

Figure 5.33(a) shows the situation as we are about to use the while-production to expand  $5$ , presumably because the lookahead symbol on the input is

while. The record at the top of stack is for  $S$ , and it contains only the inherited attribute  $S.next$ , which we suppose has the value  $x$ . Since we are now parsing top-down, we show the stack top at the left, according to our usual convention.

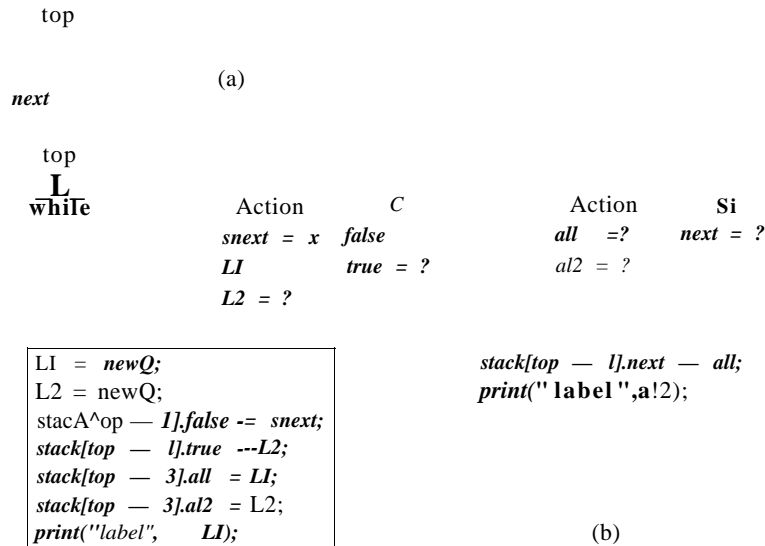

Figure 5.33: Expansion of  $S$  according to the while-statement production

Figure 5.33(b) shows the situation immediately after we have expanded  $S$ . There are action-records in front of the nonterminals  $C$  and  $S_i$ , corresponding to the actions in the underlying SDT of Fig. 5.32. The record for  $C$  has room for inherited attributes *true* and *false*, while the record for  $S_i$  has room for attribute *next*, as all  $S$ -records must. We show values for these fields as  $?$ , because we do not yet know their values.

The parser next recognizes `while` and `(` on the input and pops their records off the stack. Now, the first action is at the top, and it must be executed. This action-record has a field *snext*, which holds a copy of the inherited attribute  $S.next$ . When  $S$  is popped from the stack, the value of  $S.next$  is copied into the field *snext* for use during the evaluation of the inherited attributes for  $C$ . The code for the first action generates new values for  $L1$  and  $L2$ , which we shall suppose are  $y$  and  $z$ , respectively. The next step is to make  $z$  the value of  $C.true$ . The assignment `stack[top - 1].true = L2` is written knowing it is only executed when this action-record is at the top of stack, so `top - 1` refers to the record below it — the record for  $C$ .

The first action-record then copies  $L1$  into field *all* in the second action, where it will be used to evaluate  $S_i.next$ . It also copies  $L2$  into a field called *all* of the second action; this value is needed for that action-record to print its output properly. Finally, the first action-record prints label  $y$  to the output.

The situation after completing the first action and popping its record off



top

<i>c</i>	)	Action	<i>Si</i>
<i>false</i> = <i>x</i>		<i>al2</i> = <i>z</i>	<i>next</i> = ?
<i>true</i> = <i>z</i>		<i>all</i> = <i>y</i>	

```

stack[top - 1].next = all;
print("label", al2);

```

Figure 5.34: After the action above *C* is performed

the stack is shown in Fig. 5.34. The values of inherited attributes in the record for *C* have been filled in properly, as have the temporaries *all* and *al2* in the second action record. At this point, *C* is expanded, and we presume that the code to implement its test containing jumps to labels *x* and *z*, as appropriate, is generated. When the *C*-record is popped from the stack, the record for ) becomes top and causes the parser to check for ) on its input.

With the action above *Si* at the top of the stack, its code sets *Si.next* and emits label *z*. When that is done, the record for *Si* becomes the top of stack, and as it is expanded, we presume it correctly generates code that implements whatever kind of statement it is and then jump to label *y*. •

Example 5.24: Now, let us consider the same while-statement, but with a translation that produces the output *S.code* as a synthesized attribute, rather than by on-the-fly generation. In order to follow the explanation, it is useful to bear in mind the following invariant or inductive hypothesis, which we assume is followed for every nonterminal:

- Every nonterminal that has code associated with it leaves that code, as a string, in the synthesize-record just below it on the stack.

Assuming this statement is true, we shall handle the while-production so it maintains this statement as an invariant.

Figure 5.35(a) shows the situation just before *S* is expanded using the production for while-statements. At the top of the stack we see the record for 5; it has a field for its inherited attribute *S.next*, as in Example 5.23. Immediately below that record is the synthesize-record for this occurrence of *S*. The latter has a field for *S.code*, as all synthesize-records for *S* must have. We also show it with some other fields for local storage and actions, since the SDT for the while production in Fig. 5.28 is surely part of a larger SDT.

Our expansion of 5 is based on the SDT of Fig. 5.28, and it is shown in Fig. 5.35(b). As a shortcut, during the expansion, we assume that the inherited attribute *S.next* is assigned directly to *C.false*, rather than being placed in the first action and then copied into the record for *C*.

Let us examine what each record does when it becomes the top of stack. First, the while record causes the token while to be matched with the input,

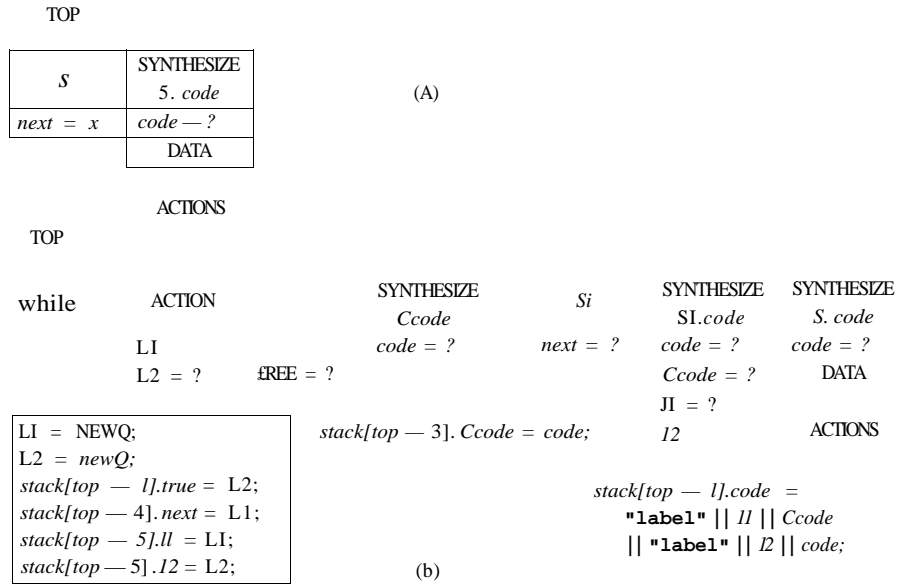

Figure 5.35: Expansion of *S* with synthesized attribute constructed on the stack

which it must, or else we would not have expanded *S* in this way. After while and ( are popped off the stack, the code for the action-record is executed. It generates values for LI and L2, and we take the shortcut of copying them directly to the inherited attributes that need them: *Si.next* and *C.true*. The last two steps of the action cause *LI* and *L2* to be copied into the record called "Synthesize *Si.code*."

The synthesize-record for *Si* does double duty: not only will it hold the synthesized attribute *Si.code*, but it will also serve as an action-record to complete the evaluation of the attributes for the entire production *S* -> while (*C*) *Si*. In particular, when it gets to the top, it will compute the synthesized attribute *S.code* and place its value in the synthesize-record for the head *S*.

When *C* becomes the top of the stack, it has both its inherited attributes computed. By the inductive hypothesis stated above, we suppose it correctly generates code to execute its condition and jump to the proper label. We also assume that the actions performed during the expansion of *C* correctly place this code in the record below, as the value of synthesized attribute *C.code*.

After *C* is popped, the synthesize-record for *C.code* becomes the top. Its code is needed in the synthesize-record for *Si.code*, because that is where we concatenate all the code elements to form *S.code*. The synthesize-record for *C.code* therefore has an action to copy *C.code* into the synthesize-record for *Si.code*. After doing so, the record for token ) reaches the top of stack, and causes a check for ) on the input. Assuming that test succeeds, the record for *Si* becomes the top of stack. By our inductive hypothesis, this nonterminal is

## Can We Handle L-Attributed SDD's on LR Grammars?

In Section 5.4.1, we saw that every S-attributed SDD on an LR grammar can be implemented during a bottom-up parse. From Section 5.5.3 every L-attributed SDD on an LL grammar can be parsed top-down. Since LL grammars are a proper subset of the LR grammars, and the S-attributed SDD's are a proper subset of the L-attributed SDD's, can we handle every LR grammar and L-attributed SDD bottom-up?

We cannot, as the following intuitive argument shows. Suppose we have a production  $A \rightarrow B C$  in an LR-grammar, and there is an inherited attribute  $B.i$  that depends on inherited attributes of  $A$ . When we reduce to  $B$ , we still have not seen the input that  $C$  generates, so we cannot be sure that we have a body of production  $A \rightarrow B C$ . Thus, we cannot compute  $B.i$  yet, since we are unsure whether to use the rule associated with this production.

Perhaps we could wait until we have reduced to  $C$ , and know that we must reduce  $B C$  to  $A$ . However, even then, we do not know the inherited attributes of  $A$ , because even after reduction, we may not be sure of the production body that contains this  $A$ . We could reason that this decision, too, should be deferred, and therefore further defer the computation of  $B.i$ . If we keep reasoning this way, we soon realize that we cannot make any decisions until the entire input is parsed. Essentially, we have reached the strategy of "build the parse tree first and then perform the translation."

expanded, and the net effect is that its code is correctly constructed and placed in the field for *code* in the synthesize-record for  $S_i$ .

Now, all the data fields of the synthesize-record for  $S_i$  have been filled in, so when it becomes the top of stack, the action in that record can be executed. The action causes the labels and code from  $C.code$  and  $S_i.code$  to be concatenated in the proper order. The resulting string is placed in the record below; that is, in the synthesize-record for  $S$ . We have now correctly computed  $S.code$ , and when the synthesize-record for  $S$  becomes the top, that code is available for placement in another record further down the stack, where it will eventually be assembled into a larger string of code implementing a program element of which this  $S$  is a part. •

### 5.5.4 Bottom-Up Parsing of L-Attributed SDD's

We can do bottom-up every translation that we can do top-down. More precisely, given an L-attributed SDD on an LL grammar, we can adapt the grammar to compute the same SDD on the new grammar during an LR parse. The "trick" has three parts:

1. Start with the SDT constructed as in Section 5.4.5, which places embedded actions before each nonterminal to compute its inherited attributes and an action at the end of the production to compute synthesized attributes.
2. Introduce into the grammar a marker nonterminal in place of each embedded action. Each such place gets a distinct marker, and there is one production for any marker  $M$ , namely  $M \rightarrow e$ .
3. Modify the action  $a$  if marker nonterminal  $M$  replaces it in some production  $A \rightarrow a \{a\} (5$ , and associate with  $M \rightarrow e$  an action  $a'$  that
  - (a) Copies, as inherited attributes of  $M$ , any attributes of  $A$  or symbols of  $a$  that action  $a$  needs.
  - (b) Computes attributes in the same way as  $a$ , but makes those attributes be synthesized attributes of  $M$ .

This change appears illegal, since typically the action associated with production  $M \rightarrow e$  will have to access attributes belonging to grammar symbols that do not appear in this production. However, we shall implement the actions on the LR parsing stack, so the necessary attributes will always be available a known number of positions down the stack.

Example 5.25 : Suppose that there is a production  $A \rightarrow B C$  in an LL grammar, and the inherited attribute  $B.i$  is computed from inherited attribute  $A.i$  by some formula  $B.i = f(A.i)$ . That is, the fragment of an SDT we care about is

$$A \rightarrow \{B.i = f(A.i);\} B C$$

We introduce marker  $M$  with inherited attribute  $M.i$  and synthesized attribute  $M.s$ . The former will be a copy of  $A.i$  and the latter will be  $B.i$ . The SDT will be written

$$\begin{aligned} A &\rightarrow M B C \\ M &\rightarrow \{M.i = A.i; M.s = f(M.i);\} \end{aligned}$$

Notice that the rule for  $M$  does not have  $A.i$  available to it, but in fact we shall arrange that every inherited attribute for a nonterminal such as  $A$  appears on the stack immediately below where the reduction to  $A$  will later take place. Thus, when we reduce  $e$  to  $M$ , we shall find  $A.i$  immediately below it, from where it may be read. Also, the value of  $M.s$ , which is left on the stack along with  $M$ , is really  $B.i$  and properly is found right below where the reduction to  $B$  will later occur. •

Example 5.26: Let us turn the SDT of Fig. 5.28 into an SDT that can operate with an LR parse of the revised grammar. We introduce a marker  $M$  before  $C$  and a marker  $N$  before  $S_i$ , so the underlying grammar becomes

## Why Markers Work

Markers are nonterminals that derive only  $e$  and that appear only once among all the bodies of all productions. We shall not give a formal proof that, when a grammar is LL, marker nonterminals can be added at any position in the body, and the resulting grammar will still be LR. The intuition, however, is as follows. If a grammar is LL, then we can determine that a string  $w$  on the input is derived from nonterminal  $A$ , in a derivation that starts with production  $A \rightarrow a$ , by seeing only the first symbol of  $w$  (or the following symbol if  $w = e$ ). Thus, if we parse  $w$  bottom-up, then the fact that a prefix of  $w$  must be reduced to  $a$  and then to  $S$  is known as soon as the beginning of  $w$  appears on the input. In particular, if we insert markers anywhere in  $a$ , the LR states will incorporate the fact that this marker has to be there, and will reduce  $e$  to the marker at the appropriate point on the input.

$$\begin{array}{lcl} S & \rightarrow & \mathbf{while} ( M C ) N Si \\ M & & e \\ N & & e \end{array}$$

Before we discuss the actions that are associated with markers  $M$  and  $N$ , let us outline the "inductive hypothesis" about where attributes are stored.

1. Below the entire body of the while-production — that is, below **while** on the stack — will be the inherited attribute  $S.next$ . We may not know the nonterminal or parser state associated with this stack record, but we can be sure that it will have a field, in a fixed position of the record, that holds  $S.next$  before we begin to recognize what is derived from this  $S$ .
2. Inherited attributes  $C.true$  and  $C.false$  will be just below the stack record for  $C$ . Since the grammar is presumed to be LL, the appearance of **while** on the input assures us that the while-production is the only one that can be recognized, so we can be sure that  $M$  will appear immediately below  $C$  on the stack, and  $M$ 's record will hold the inherited attributes of  $C$ .
3. Similarly, the inherited attribute  $Si.next$  must appear immediately below  $Si$  on the stack, so we may place that attribute in the record for  $N$ .
4. The synthesized attribute  $C.code$  will appear in the record for  $C$ . As always when we have a long string as an attribute value, we expect that in practice a pointer to (an object representing) the string will appear in the record, while the string itself is outside the stack.
5. Similarly, the synthesized attribute  $Si.code$  will appear in the record for  $Si$ .

Let us follow the parsing process for a while-statement. Suppose that a record holding *S.next* appears on the top of the stack, and the next input is the terminal **while**. We shift this terminal onto the stack. It is then certain that the production being recognized is the while-production, so the LR parser can shift "(" and determine that its next step must be to reduce *e* to *M*. The stack at this time is shown in Fig. 5.36. We also show in that figure the action that is associated with the reduction to *M*. We create values for *LI* and *L2*, which live in fields of the *M*-record. Also in that record are fields for *C.true* and *C.false*. These attributes must be in the second and third fields of the record, for consistency with other stack records that might appear below *C* in other contexts and also must provide these attributes for *C*. The action completes by assigning values to *C.true* and *C.false*, one from the *L2* just generated, and the other by reaching down the stack to where we know *S.next* is found.

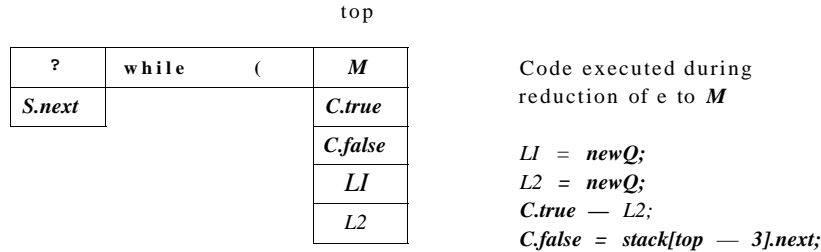
Figure 5.36: LR parsing stack after reduction of *e* to *M*

We presume that the next inputs are properly reduced to *C*. The synthesized attribute *C.code* is therefore placed in the record for *C*. This change to the stack is shown in Fig. 5.37, which also incorporates the next several records that are later placed above *C* on the stack.

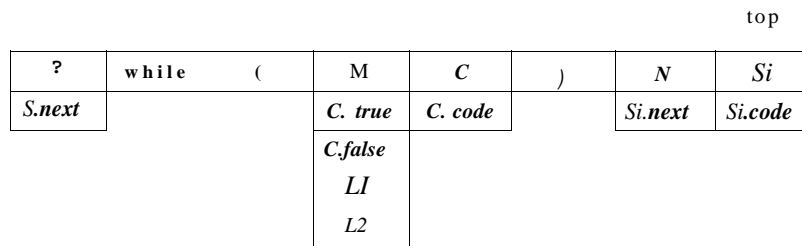
Figure 5.37: Stack just before reduction of the while-production body to *S*

Continuing with the recognition of the while-statement, the parser should next find ")" on the input, which it pushes onto the stack in a record of its own. At that point, the parser, which knows it is working on a while-statement because the grammar is LL, will reduce *e* to *N*. The single piece of data associated with *N* is the inherited attribute *Si.next*. Note that this attribute needs

to be in the record for  $N$  because that will be just below the record for  $S_i$ . The code that is executed to compute the value of  $S_i.next$  is

$$S_i.next = stack[top - 3].LI;$$

This action reaches three records below TV, which is at the top of stack when the code is executed, and retrieves the value of LI.

Next, the parser reduces some prefix of the remaining input to  $S$ , which we have consistently referred to as  $S_i$  to distinguish it from the  $S$  at the head of the production. The value of  $S_i.code$  is computed and appears in the stack record for  $S_i$ . This step takes us to the condition that is illustrated in Fig. 5.37.

At this point, the parser will reduce everything from **while** to  $S_i$  to  $S$ . The code that is executed during this reduction is:

```
tempCode = label || stack[top - 4].LI || stack[top - 3].code ||
  label || stack[top - 4].L2 || stack[top].code;
top = top - 5;
stack[top].code = tempCode;
```

That is, we construct the value of  $S.code$  in a variable  $tempCode$ . That code is the usual, consisting of the two labels LI and L2, the code for  $C$  and the code for  $S_i$ . The stack is popped, so  $S$  appears where **while** was. The value of the code for  $S$  is placed in the *code* field of that record, where it can be interpreted as the synthesized attribute  $S.code$ . Note that we do not show, in any of this discussion, the manipulation of LR states, which must also appear on the stack in the field that we have populated with grammar symbols. •

### 5.5.5 Exercises for Section 5.5

**Exercise 5.5.1:** Implement each of your SDD's of Exercise 5.4.4 as a recursive-descent parser in the style of Section 5.5.1.

**Exercise 5.5.2:** Implement each of your SDD's of Exercise 5.4.4 as a recursive-descent parser in the style of Section 5.5.2.

**Exercise 5.5.3:** Implement each of your SDD's of Exercise 5.4.4 with an LL parser in the style of Section 5.5.3, with code generated "on the fly."

**Exercise 5.5.4:** Implement each of your SDD's of Exercise 5.4.4 with an LL parser in the style of Section 5.5.3, but with code (or pointers to the code) stored on the stack.

**Exercise 5.5.5:** Implement each of your SDD's of Exercise 5.4.4 with an LR parser in the style of Section 5.5.4.

**Exercise 5.5.6:** Implement your SDD of Exercise 5.2.4 in the style of Section 5.5.1. Would an implementation in the style of Section 5.5.2 be any different?

## .6 Summary of Chapter 5

- 4 *Inherited and Synthesized Attributes:* Syntax-directed definitions may use two kinds of attributes. A synthesized attribute at a parse-tree node is computed from attributes at its children. An inherited attribute at a node is computed from attributes at its parent and/or siblings.
- *Dependency Graphs:* Given a parse tree and an SDD, we draw edges among the attribute instances associated with each parse-tree node to denote that the value of the attribute at the head of the edge is computed in terms of the value of the attribute at the tail of the edge.
- *Cyclic Definitions:* In problematic SDD's, we find that there are some parse trees for which it is impossible to find an order in which we can compute all the attributes at all nodes. These parse trees have cycles in their associated dependency graphs. It is intractable to decide whether an SDD has such circular dependency graphs.
- 4 *S-Attributed Definitions:* In an S-attributed SDD, all attributes are synthesized.
- 4 *L-Attributed Definitions:* In an L-attributed SDD, attributes may be inherited or synthesized. However, inherited attributes at a parse-tree node may depend only on inherited attributes of its parent and on (any) attributes of siblings to its left.
- *Syntax Trees:* Each node in a syntax tree represents a construct; the children of the node represent the meaningful components of the construct.
- 4 *Implementing S-Attributed SDD's:* An S-attributed definition can be implemented by an SDT in which all actions are at the end of the production (a "postfix" SDT). The actions compute the synthesized attributes of the production head in terms of synthesized attributes of the symbols in the body. If the underlying grammar is LR, then this SDT can be implemented on the LR parser stack.
- 4 *Eliminating Left Recursion From SDT's:* If an SDT has only side-effects (no attributes are computed), then the standard left-recursion-elimination algorithm for grammars allows us to carry the actions along as if they were terminals. When attributes are computed, we can still eliminate left recursion if the SDT is a postfix SDT.
- 4 *Implementing L-attributed SDD's by Recursive-Descent Parsing:* If we have an L-attributed definition on a top-down parsable grammar, we can build a recursive-descent parser with no backtracking to implement the translation. Inherited attributes become arguments of the functions for their nonterminals, and synthesized attributes are returned by that function.



- *Implementing L-Attributed SDD's on an LL Grammar:* Every L-attributed definition with an underlying LL grammar can be implemented along with the parse. Records to hold the synthesized attributes for a nonterminal are placed below that nonterminal on the stack, while inherited attributes for a nonterminal are stored with that nonterminal on the stack. Action records are also placed on the stack to compute attributes at the appropriate time.
- *Implementing L-Attributed SDD's on an LL Grammar, Bottom-Up:* An L-attributed definition with an underlying LL grammar can be converted to a translation on an LR grammar and the translation performed in connection with a bottom-up parse. The grammar transformation introduces "marker" nonterminals that appear on the bottom-up parser's stack and hold inherited attributes of the nonterminal above it on the stack. Synthesized attributes are kept with their nonterminal on the stack.

## 5.7 References for Chapter 5

Syntax-directed definitions are a form of inductive definition in which the induction is on the syntactic structure. As such they have long been used informally in mathematics. Their application to programming languages came with the use of a grammar to structure the Algol 60 report.

The idea of a parser that calls for semantic actions can be found in Samelson and Bauer [8] and Brooker and Morris [1]. Irons [2] constructed one of the first syntax-directed compilers, using synthesized attributes. The class of L-attributed definitions comes from [6].

Inherited attributes, dependency graphs, and a test for circularity of SDD's (that is, whether or not there is some parse tree with no order in which the attributes can be computed) are from Knuth [5]. Jazayeri, Ogden, and Rounds [3] showed that testing circularity requires exponential time, as a function of the size of the SDD.

Parser generators such as Yacc [4] (see also the bibliographic notes in Chapter 4) support attribute evaluation during parsing.

The survey by Paakki [7] is a starting point for accessing the extensive literature on syntax-directed definitions and translations.

1. Brooker, R. A. and D. Morris, "A general translation program for phrase structure languages," *J. ACM* 9:1 (1962), pp. 1-10.
2. Irons, E. T., "A syntax directed compiler for Algol 60," *Comm. ACM* 4:1 (1961), pp. 51-55.
3. Jazayeri, M., W. F. Odgen, and W. C. Rounds, "The intrinsic exponential complexity of the circularity problem for attribute grammars," *Comm. ACM* 18:12 (1975), pp. 697-706.

4. Johnson, S. C, "Yacc — Yet Another Compiler Compiler," Computing Science Technical Report 32, Bell Laboratories, Murray Hill, NJ, 1975. Available at <http://dinosaur.compilertools.net/yacc/> .
5. Knuth, D.E., "Semantics of context-free languages," *Mathematical Systems Theory* 2:2 (1968), pp. 127-145. See also *Mathematical Systems Theory* 5:1 (1971), pp. 95-96.
6. Lewis, P. M. II, D. J. Rosenkrantz, and R. E. Stearns, "Attributed translations," *J. Computer and System Sciences* 9:3 (1974), pp. 279-307.
7. Paakki, J., "Attribute grammar paradigms — a high-level methodology in language implementation," *Computing Surveys* 27:2 (1995) pp. 196-255.
8. Samelson, K. and F. L. Bauer, "Sequential formula translation," *Comm. ACM* 3:2 (1960), pp. 76-83.



# Chapter 6

## Intermediate-Code Generation

In the analysis-synthesis model of a compiler, the front end analyzes a source program and creates an intermediate representation, from which the back end generates target code. Ideally, details of the source language are confined to the front end, and details of the target machine to the back end. With a suitably defined intermediate representation, a compiler for language  $i$  and machine  $j$  can then be built by combining the front end for language  $i$  with the back end for machine  $j$ . This approach to creating suite of compilers can save a considerable amount of effort:  $m \times n$  compilers can be built by writing just  $m$  front ends and  $n$  back ends.

This chapter deals with intermediate representations, static type checking, and intermediate code generation. For simplicity, we assume that a compiler front end is organized as in Fig. 6.1, where parsing, static checking, and intermediate-code generation are done sequentially; sometimes they can be combined and folded into parsing. We shall use the syntax-directed formalisms of Chapters 2 and 5 to specify checking and translation. Many of the translation schemes can be implemented during either bottom-up or top-down parsing, using the techniques of Chapter 5. All schemes can be implemented by creating a syntax tree and then walking the tree.

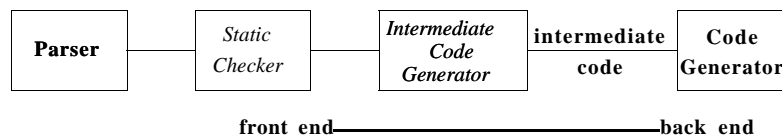

Figure 6.1: Logical structure of a compiler front end

Static checking includes *type checking*, which ensures that operators are applied to compatible operands. It also includes any syntactic checks that remain

after parsing. For example, static checking assures that a break-statement in C is enclosed within a while-, for-, or switch-statement; an error is reported if such an enclosing statement does not exist.

The approach in this chapter can be used for a wide range of intermediate representations, including syntax trees and three-address code, both of which were introduced in Section 2.8. The term "three-address code" comes from instructions of the general form  $x = y \text{ op } z$  with three addresses: two for the operands  $y$  and  $z$  and one for the result  $x$ .

In the process of translating a program in a given source language into code for a given target machine, a compiler may construct a sequence of intermediate representations, as in Fig. 6.2. High-level representations are close to the source language and low-level representations are close to the target machine. Syntax trees are high level; they depict the natural hierarchical structure of the source program and are well suited to tasks like static type checking.

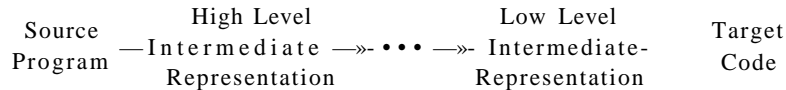

Figure 6.2: A compiler might use a sequence of intermediate representations

A low-level representation is suitable for machine-dependent tasks like register allocation and instruction selection. Three-address code can range from high- to low-level, depending on the choice of operators. For expressions, the differences between syntax trees and three-address code are superficial, as we shall see in Section 6.2.3. For looping statements, for example, a syntax tree represents the components of a statement, whereas three-address code contains labels and jump instructions to represent the flow of control, as in machine language.

The choice or design of an intermediate representation varies from compiler to compiler. An intermediate representation may either be an actual language or it may consist of internal data structures that are shared by phases of the compiler. C is a programming language, yet it is often used as an intermediate form because it is flexible, it compiles into efficient machine code, and its compilers are widely available. The original C++ compiler consisted of a front end that generated C, treating a C compiler as a back end.

## 6.1 Variants of Syntax Trees

Nodes in a syntax tree represent constructs in the source program; the children of a node represent the meaningful components of a construct. A directed acyclic graph (hereafter called a *DAG*) for an expression identifies the *common subexpressions* (subexpressions that occur more than once) of the expression. As we shall see in this section, DAG's can be constructed by using the same techniques that construct syntax trees.

### 6.1.1 Directed Acyclic Graphs for Expressions

Like the syntax tree for an expression, a DAG has leaves corresponding to atomic operands and interior nodes corresponding to operators. The difference is that a node  $N$  in a DAG has more than one parent if  $N$  represents a common subexpression; in a syntax tree, the tree for the common subexpression would be replicated as many times as the subexpression appears in the original expression. Thus, a DAG not only represents expressions more succinctly, it gives the compiler important clues regarding the generation of efficient code to evaluate the expressions.

Example 6.1: Figure 6.3 shows the DAG for the expression

$$a + a * (b - c) + (b - c) * d$$

The leaf for  $a$  has two parents, because  $a$  appears twice in the expression. More interestingly, the two occurrences of the common subexpression  $b-c$  are represented by one node, the node labeled  $-$ . That node has two parents, representing its two uses in the subexpressions  $a*(b-c)$  and  $(b-c)*d$ . Even though  $b$  and  $c$  appear twice in the complete expression, their nodes each have one parent, since both uses are in the common subexpression  $b-c$ . •

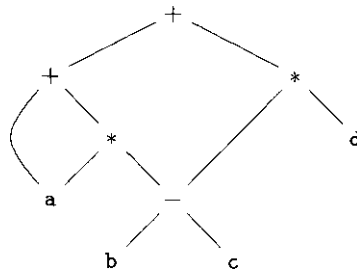

Figure 6.3: Dag for the expression  $a + a * (b - c) + (b - c) * d$

The SDD of Fig. 6.4 can construct either syntax trees or DAG's. It was used to construct syntax trees in Example 5.11, where functions *Leaf* and *Node* created a fresh node each time they were called. It will construct a DAG if, before creating a new node, these functions first check whether an identical node already exists. If a previously created identical node exists, the existing node is returned. For instance, before constructing a new node,  $Node(op, left, right)$  we check whether there is already a node with label *op*, and children *left* and *right*, in that order. If so, *Node* returns the existing node; otherwise, it creates a new node.

Example 6.2: The sequence of steps shown in Fig. 6.5 constructs the DAG in Fig. 6.3, provided *Node* and *Leaf* return an existing node, if possible, as

	PRODUCTION	SEMANTIC RULES
1)	$E \rightarrow E_1 + T$	$E.node = \mathbf{new} \text{ Node}('+', E.node, T.node)$
2)	$E \rightarrow E_1 - T$	$E.node = \mathbf{new} \text{ Node}('-', E.node, T.node)$
3)	$E \rightarrow T$	$E.node = T.node$
4)		$T.node = E.node$
5)	<b>T - M d</b>	$T.node = \mathbf{new} \text{ Leaf}(\mathbf{id}, \mathbf{id}, \mathbf{entry})$
6)	$T \rightarrow \mathbf{num}$	$T.node = \mathbf{new} \text{ Leaf}(\mathbf{num}, \mathbf{mmi.val})$

Figure 6.4: Syntax-directed definition to produce syntax trees or DAG's

- 1)  $pi = \text{Leaf}(\mathbf{id}, \mathbf{entry-a})$
- 2)  $pi = \text{Leaf}(\mathbf{id}, \mathbf{entry-a}) = p_1$
- 3)  $P3 = \text{Leaf}(\mathbf{id}, \mathbf{entry-b})$
- 4)  $PA = \text{Leaf}(\mathbf{id}, \mathbf{entry-c})$
- 5)  $Ps = \text{Node}('-', P3, PA)$
- 6)  $p_s = \text{Node}('*', pi, ps)$
- 7)  $Pi = \text{Node}('+', pi, p_s)$
- 8)  $ps = \text{Leaf}(\mathbf{id}, \mathbf{entry-b}) = p_3$
- 9)  $PQ = \text{Leaf}(\mathbf{id}, \mathbf{entry-c}) = p^4$
- 10)  $pio = \text{Node}('-', P3, P4) = P5$
- 11)  $Pn = \text{Leaf}(\mathbf{id}, \mathbf{entry-d})$
- 12)  $pi_2 = \text{Node}('*', p_s, pii)$
- 13)  $pis = \text{Node}('+', p_s, pi_2)$

Figure 6.5: Steps for constructing the DAG of Fig. 6.3

discussed above. We assume that *entry-a* points to the symbol-table entry for **a**, and similarly for the other identifiers.

When the call to *Leaf(id, entry-a)* is repeated at step 2, the node created by the previous call is returned, so  $p_2 = P1$ . Similarly, the nodes returned at steps 8 and 9 are the same as those returned at steps 3 and 4 (i.e.,  $ps = p_3$  and  $PQ = p^4$ ). Hence the node returned at step 10 must be the same as that returned at step 5; i.e.,  $pio = P5$ .

### 6.1.2 The Value-Number Method for Constructing DAG's

Often, the nodes of a syntax tree or DAG are stored in an array of records, as suggested by Fig. 6.6. Each row of the array represents one record, and therefore one node. In each record, the first field is an operation code, indicating the label of the node. In Fig. 6.6(b), leaves have one additional field, which holds the lexical value (either a symbol-table pointer or a constant, in this case), and

interior nodes have two additional fields indicating the left and right children.

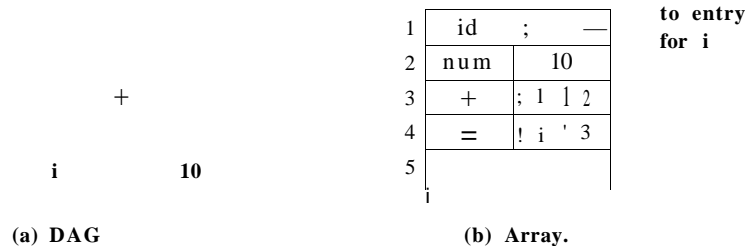

Figure 6.6: Nodes of a DAG for  $i = i + 10$  allocated in an array

In this array, we refer to nodes by giving the integer index of the record for that node within the array. This integer historically has been called the *value number* for the node or for the expression represented by the node. For instance, in Fig. 6.6, the node labeled ~~+~~ has value number 3, and its left and right children have value numbers 1 and 2, respectively. In practice, we could use pointers to records or references to objects instead of integer indexes, but we shall still refer to the reference to a node as its "value number." If stored in an appropriate data structure, value numbers help us construct expression DAG's efficiently; the next algorithm shows how.

Suppose that nodes are stored in an array, as in Fig. 6.6, and each node is referred to by its value number. Let the *signature* of an interior node be the triple  $(op, l, r)$ , where  $op$  is the label,  $l$  its left child's value number, and  $r$  its right child's value number. A unary operator may be assumed to have  $r = 0$ .

**Algorithm 6.3** The value-number method for constructing the nodes of a DAG.

**INPUT:** Label  $op$ , node  $l$ , and node  $r$ .

**OUTPUT:** The value number of a node in the array with signature  $(op, l, r)$ .

**METHOD:** Search the array for a node  $M$  with label  $op$ , left child  $l$ , and right child  $r$ . If there is such a node, return the value number of  $M$ . If not, create in the array a new node  $N$  with label  $op$ , left child  $l$ , and right child  $r$ , and return its value number. •

While Algorithm 6.3 yields the desired output, searching the entire array every time we are asked to locate one node is expensive, especially if the array holds expressions from an entire program. A more efficient approach is to use a hash table, in which the nodes are put into "buckets," each of which typically will have only a few nodes. The hash table is one of several data structures that support *dictionaries* efficiently.<sup>1</sup> A dictionary is an abstract data type that

<sup>1</sup>See Aho, A. V., J. E. Hopcroft, and J. D. Ullman, *Data Structures and Algorithms*, Addison-Wesley, 1983, for a discussion of data structures supporting dictionaries.



allows us to insert and delete elements of a set, and to determine whether a given element is currently in the set. A good data structure for dictionaries, such as a hash table, performs each of these operations in time that is constant or close to constant, independent of the size of the set.

To construct a hash table for the nodes of a DAG, we need a *hash function*  $h$  that computes the index of the bucket for a signature  $(op, I, r)$ , in a way that distributes the signatures across buckets, so that it is unlikely that any one bucket will get much more than a fair share of the nodes. The bucket index  $h(op, I, r)$  is computed deterministically from  $op$ ,  $I$ , and  $r$ , so that we may repeat the calculation and always get to the same bucket index for node  $(op, I, r)$ .

The buckets can be implemented as linked lists, as in Fig. 6.7. An array, indexed by hash value, holds the *bucket headers*, each of which points to the first cell of a list. Within the linked list for a bucket, each cell holds the value number of one of the nodes that hash to that bucket. That is, node  $(op, l, r)$  can be found on the list whose header is at index  $h(op, l, r)$  of the array.

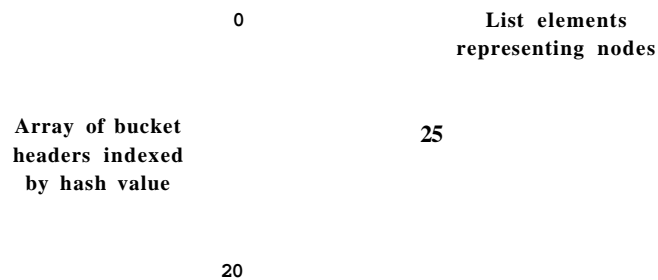

Figure 6.7: Data structure for searching buckets

Thus, given the input node  $op$ ,  $I$ , and  $r$ , we compute the bucket index  $h(op, l, r)$  and search the list of cells in this bucket for the given input node. Typically, there are enough buckets so that no list has more than a few cells. We may need to look at all the cells within a bucket, however, and for each value number  $v$  found in a cell, we must check whether the signature  $(op, l, r)$  of the input node matches the node with value number  $v$  in the list of cells (as in Fig. 6.7). If we find a match, we return  $v$ . If we find no match, we know no such node can exist in any other bucket, so we create a new cell, add it to the list of cells for bucket index  $h(op, l, r)$ , and return the value number in that new cell.

### 6.1.3 Exercises for Section 6.1

Exercise 6.1.1: Construct the DAG for the expression

$$((a; + y) - ((x + y) * (x - y))) + ((x + y) * (x - y))$$

Exercise 6.1.2: Construct the DAG and identify the value numbers for the subexpressions of the following expressions, assuming + associates from the left.

- a)  $a + b + (a + b)$ .
- b)  $a + b + a + b$ .
- c)  $a + a + ((fl + a + a + (a + a + a + a)))$ .

## 6.2 Three-Address Code

In three-address code, there is at most one operator on the right side of an instruction; that is, no built-up arithmetic expressions are permitted. Thus a source-language expression like  $x+y*z$  might be translated into the sequence of three-address instructions

$$\begin{aligned}t_1 &= y * z \\t_2 &= x + t_1\end{aligned}$$

where  $t_1$  and  $t_2$  are compiler-generated temporary names. This unraveling of multi-operator arithmetic expressions and of nested flow-of-control statements makes three-address code desirable for target-code generation and optimization, as discussed in Chapters 8 and 9. The use of names for the intermediate values computed by a program allows three-address code to be rearranged easily.

Example 6.4: Three-address code is a linearized representation of a syntax tree or a DAG in which explicit names correspond to the interior nodes of the graph. The DAG in Fig. 6.3 is repeated in Fig. 6.8, together with a corresponding three-address code sequence. •

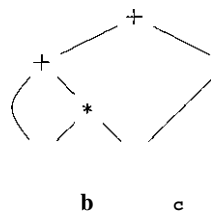

(a) DAG

$$\begin{aligned}t_1 &= b - c \\t_2 &= a * t_1 \\t_3 &= a + t_2 \\t_4 &= t_1 * d \\t_5 &= t_3 + t_4\end{aligned}$$

(b) Three-address code

Figure 6.8: A DAG and its corresponding three-address code

### 6.2.1 Addresses and Instructions

Three-address code is built from two concepts: addresses and instructions. In object-oriented terms, these concepts correspond to classes, and the various kinds of addresses and instructions correspond to appropriate subclasses. Alternatively, three-address code can be implemented using records with fields for the addresses; records called quadruples and triples are discussed briefly in Section 6.2.2.

An address can be one of the following:

- A *name*. For convenience, we allow source-program names to appear as addresses in three-address code. In an implementation, a source name is replaced by a pointer to its symbol-table entry, where all information about the name is kept.
- A *constant*. In practice, a compiler must deal with many different types of constants and variables. Type conversions within expressions are considered in Section 6.5.2.
- A *compiler-generated temporary*. It is useful, especially in optimizing compilers, to create a distinct name each time a temporary is needed. These temporaries can be combined, if possible, when registers are allocated to variables.

We now consider the common three-address instructions used in the rest of this book. Symbolic labels will be used by instructions that alter the flow of control. A symbolic label represents the index of a three-address instruction in the sequence of instructions. Actual indexes can be substituted for the labels, either by making a separate pass or by "backpatching," discussed in Section 6.7. Here is a list of the common three-address instruction forms:

1. Assignment instructions of the form  $x = y \text{ op } z$ , where *op* is a binary arithmetic or logical operation, and *x*, *y*, and *z* are addresses.
2. Assignments of the form  $x = \text{op } y$ , where *op* is a unary operation. Essential unary operations include unary minus, logical negation, shift operators, and conversion operators that, for example, convert an integer to a floating-point number.
3. *Copy instructions* of the form  $x = y$ , where *x* is assigned the value of *y*.
4. An unconditional jump `goto L`. The three-address instruction with label *L* is the next to be executed.
5. Conditional jumps of the form `if x goto L` and `ifFalse x goto L`. These instructions execute the instruction with label *L* next if *x* is true and false, respectively. Otherwise, the following three-address instruction in sequence is executed next, as usual.

6. Conditional jumps such as `if x relop y goto L`, which apply a relational operator (<, ==, >=, etc.) to  $x$  and  $y$ , and execute the instruction with label  $L$  next if  $x$  stands in relation *relop* to  $y$ . If not, the three-address instruction following `if x relop y goto L` is executed next, in sequence.
7. Procedure calls and returns are implemented using the following instructions: `param x` for parameters; `call p, n` and `y = call p, n` for procedure and function calls, respectively; and `return y`, where  $y$ , representing a returned value, is optional. Their typical use is as the sequence of three-address instructions

```

param x1
param x2

param xn
call p, n

```

generated as part of a call of the procedure  $p(x_1, x_2, \dots, x_n)$ . The integer  $n$ , indicating the number of actual parameters in "`call p, n`," is not redundant because calls can be nested. That is, some of the first `param` statements could be parameters of a call that comes after  $p$  returns its value; that value becomes another parameter of the later call. The implementation of procedure calls is outlined in Section 6.9.

8. Indexed copy instructions of the form `x = y[i]` and `x[i] = y`. The instruction `x = y[i]` sets  $x$  to the value in the location  $i$  memory units beyond location  $y$ . The instruction `x[i] = y` sets the contents of the location  $i$  units beyond  $x$  to the value of  $y$ .
9. Address and pointer assignments of the form `x = &y`, `x = *y`, and `*x = y`. The instruction `x = &y` sets the r-value of  $x$  to be the location (l-value) of  $y$ . Presumably  $y$  is a name, perhaps a temporary, that denotes an expression with an l-value such as  $A[i][j]$ , and  $\#$  is a pointer name or temporary. In the instruction `x = *y`, presumably  $y$  is a pointer or a temporary whose r-value is a location. The r-value of  $x$  is made equal to the contents of that location. Finally, `*x = y` sets the r-value of the object pointed to by  $x$  to the r-value of  $y$ .

**Example 6.5:** Consider the statement

```
do i = i+1; while (a[i] < v);
```

Two possible translations of this statement are shown in Fig. 6.9. The translation in Fig. 6.9 uses a symbolic label  $L$ , attached to the first instruction. The

<sup>3</sup>From Section 2.8.3, l- and r-values are appropriate on the left and right sides of assignments, respectively.

translation in (b) shows position numbers for the instructions, starting arbitrarily at position 100. In both translations, the last instruction is a conditional jump to the first instruction. The multiplication  $i * 8$  is appropriate for an array of elements that each take 8 units of space. •

$t_1 = i + 1$ $i = t_1$ $t_2 = i * 8$ $t_3 = a [ t_2 ]$ if $t_3 < v$ goto L	100   $t_1 = i + 1$ 101   $i = t_1$ 102   $t_2 = i * 8$ 103   $t_3 = a [ t_2 ]$ 104   if $t_3 < v$ goto
(a) Symbolic labels.	(b) Position numbers.

Figure 6.9: Two ways of assigning labels to three-address statements

The choice of allowable operators is an important issue in the design of an intermediate form. The operator set clearly must be rich enough to implement the operations in the source language. Operators that are close to machine instructions make it easier to implement the intermediate form on a target machine. However, if the front end must generate long sequences of instructions for some source-language operations, then the optimizer and code generator may have to work harder to rediscover the structure and generate good code for these operations.

## 6.2.2 Quadruples

The description of three-address instructions specifies the components of each type of instruction, but it does not specify the representation of these instructions in a data structure. In a compiler, these instructions can be implemented as objects or as records with fields for the operator and the operands. Three such representations are called "quadruples," "triples," and "indirect triples."

A *quadruple* (or just "*quad!*") has four fields, which we call *op*, *arg<sub>1</sub>*, *arg<sub>2</sub>*, and *result*. The *op* field contains an internal code for the operator. For instance, the three-address instruction  $x = y + z$  is represented by placing  $+$  in *op*,  $y$  in *arg<sub>1</sub>*,  $z$  in *arg<sub>2</sub>*, and  $x$  in *result*. The following are some exceptions to this rule:

1. Instructions with unary operators like  $x = \text{minus } y$  or  $x = y$  do not use *arg<sub>2</sub>*. Note that for a copy statement like  $x = y$ , *op* is  $=$ , while for most other operations, the assignment operator is implied.
2. Operators like *par am* use neither *arg<sub>1</sub>*, nor *result*.
3. Conditional and unconditional jumps put the target label in *result*.

**Example 6.6:** Three-address code for the assignment  $a = b * -c + b * -c$ ; appears in Fig. 6.10(a). The special operator *minus* is used to distinguish the

unary minus operator, as in  $-c$ , from the binary minus operator, as in  $b - c$ . Note that the unary-minus "three-address" statement has only two addresses, as does the copy statement  $a = t_5$ .

The quadruples in Fig. 6.10(b) implement the three-address code in (a). •

```

t1 = minus c
t2 = b * t1
t3 = minus c
t4 = b * t3
t5 = t2 + t4
a = t5

```

(a) Three-address code

	<i>op</i>	<i>arg<sub>1</sub></i>	<i>arg<sub>2</sub></i>	<i>result</i>
0	minus	i	c	t1
1	*	i	b	t2
2	minus	i	c	! t3
3	*	i	b	! t4
4	+	i	t2	! t5
5	=	t	t5	i a

(b) Quadruples

Figure 6.10: Three-address code and its quadruple representation

For readability, we use actual identifiers like  $a$ ,  $b$ , and  $c$  in the fields *arg<sub>1</sub>*, *arg<sub>2</sub>*, and *result* in Fig. 6.10(b), instead of pointers to their symbol-table entries. Temporary names can either be entered into the symbol table like programmer-defined names, or they can be implemented as objects of a class *Temp* with its own methods.

### 6.2.3 Triples

A *triple* has only three fields, which we call *op*, *arg<sub>1</sub>*, and *arg<sub>2</sub>*. Note that the *result* field in Fig. 6.10(b) is used primarily for temporary names. Using triples, we refer to the result of an operation  $x \text{ op } y$  by its position, rather than by an explicit temporary name. Thus, instead of the temporary  $t_1$  in Fig. 6.10(b), a triple representation would refer to position (0). Parenthesized numbers represent pointers into the triple structure itself. In Section 6.1.2, positions or pointers to positions were called value numbers.

Triples are equivalent to signatures in Algorithm 6.3. Hence, the DAG and triple representations of expressions are equivalent. The equivalence ends with expressions, since syntax-tree variants and three-address code represent control flow quite differently.

**Example 6.7:** The syntax tree and triples in Fig. 6.11 correspond to the three-address code and quadruples in Fig. 6.10. In the triple representation in Fig. 6.11(b), the copy statement  $a = t_5$  is encoded in the triple representation by placing  $a$  in the *arg<sub>2</sub>* field and (4) in the *arg<sub>1</sub>* field. •

A ternary operation like  $x[i] = y$  requires two entries in the triple structure; for example, we can put  $x$  and  $i$  in one triple and  $y$  in the next. Similarly,  $x = y[\%]$  can be implemented by treating it as if it were the two instructions

## Why Do We Need Copy Instructions?

A simple algorithm for translating expressions generates copy instructions for assignments, as in Fig. 6.10(a), where we copy  $t_1$  into  $a$  rather than assigning  $t_1 + 14$  to  $a$  directly. Each subexpression typically gets its own, new temporary to hold its result, and only when the assignment operator  $=$  is processed do we learn where to put the value of the complete expression. A code-optimization pass, perhaps using the DAG of Section 6.1.1 as an intermediate form, can discover that  $a$  can be replaced by  $a$ .

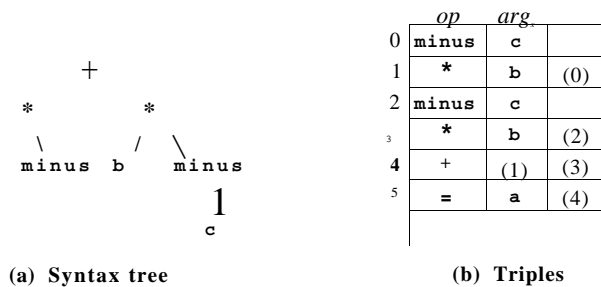

Figure 6.11: Representations of  $a + a * (b - c) + (b - c) * d$

$t = y[i]$  and  $x = t$ , where  $i$  is a compiler-generated temporary. Note that the temporary  $t$  does not actually appear in a triple, since temporary values are referred to by their position in the triple structure.

A benefit of quadruples over triples can be seen in an optimizing compiler, where instructions are often moved around. With quadruples, if we move an instruction that computes a temporary  $t$ , then the instructions that use  $t$  require no change. With triples, the result of an operation is referred to by its position, so moving an instruction may require us to change all references to that result. This problem does not occur with indirect triples, which we consider next.

*Indirect triples* consist of a listing of pointers to triples, rather than a listing of triples themselves. For example, let us use an array *instruction* to list pointers to triples in the desired order. Then, the triples in Fig. 6.11(b) might be represented as in Fig. 6.12.

With indirect triples, an optimizing compiler can move an instruction by reordering the *instruction* list, without affecting the triples themselves. When implemented in Java, an array of instruction objects is analogous to an indirect triple representation, since Java treats the array elements as references to objects.

<i>instruction</i>		<i>op</i>	<i>arg.</i>	<i>arg.</i>
35	(0)	minus	c	
36	(1)	*	b	(0)
37	(2)	minus	c	
38	(3)	*	b	(2)
39	(4)	+	(1)	(3)
40	(5)	=	a	(4)

Figure 6.12: Indirect triples representation of three-address code

## 6.2.4 Static Single-Assignment Form

Static single-assignment form (SSA) is an intermediate representation that facilitates certain code optimizations. Two distinctive aspects distinguish SSA from three-address code. The first is that all assignments in SSA are to variables with distinct names; hence the term *static single-assignment*. Figure 6.13 shows the same intermediate program in three-address code and in static single-assignment form. Note that subscripts distinguish each definition of variables  $p$  and  $q$  in the SSA representation.

$p = a + b$	$p_1 = a + b$
$q = p - c$	$q_1 = p_1 - c$
$p = q * d$	$p_2 = q_1 * d$
$P = p - P$	$P_3 = p_2 - P_2$
$q = p + q$	$q_2 = P_3 + q_1$

(a) Three-address code. (b) Static single-assignment form.

Figure 6.13: Intermediate program in three-address code and SSA

The same variable may be defined in two different control-flow paths in a program. For example, the source program

```
if ( flag ) x = -1; else x = 1;
y = x * a;
```

has two control-flow paths in which the variable  $x$  gets defined. If we use different names for  $x$  in the true part and the false part of the conditional statement, then which name should we use in the assignment  $y = x * a$ ? Here is where the second distinctive aspect of SSA comes into play. SSA uses a notational convention called the  $\wedge$ -function to combine the two definitions of  $x$ :

```
if ( flag ) x1 = -1; else x2 = 1;
x3 =  $\wedge(x_1, x_2)$ ;
```



Here,  $(j)(x_s, x_t)$  has the value  $x_s$  if the control flow passes through the true part of the conditional and the value  $x_t$  if the control flow passes through the false part. That is to say, the  $\wedge$ -function returns the value of its argument that corresponds to the control-flow path that was taken to get to the assignment-statement containing the  $\wedge$ -function.

### 6.2.5 Exercises for Section 6.2

**Exercise 6.2.1:** Translate the arithmetic expression  $a + -(\& \mathbf{-I} c)$  into:

- a) A syntax tree.
- b) Quadruples.
- c) Triples.
- d) Indirect triples.

**Exercise 6.2.2:** Repeat Exercise 6.2.1 for the following assignment statements:

*i.*  $a = b[i] + c[j]$ .

*ii.*  $a[i] = b*c - b*d$ .

*Hi.*  $x = f(y+1) + 2$ .

*iv.*  $x = *p + \&y$ .

**! Exercise 6.2.3:** Show how to transform a three-address code sequence into one in which each defined variable gets a unique variable name.

## 6.3 Types and Declarations

The applications of types can be grouped under checking and translation:

- *Type checking* uses logical rules to reason about the behavior of a program at run time. Specifically, it ensures that the types of the operands match the type expected by an operator. For example, the  $\&\&$  operator in Java expects its two operands to be booleans; the result is also of type boolean.
- *Translation Applications.* From the type of a name, a compiler can determine the storage that will be needed for that name at run time. Type information is also needed to calculate the address denoted by an array reference, to insert explicit type conversions, and to choose the right version of an arithmetic operator, among other things.

In this section, we examine types and storage layout for names declared within a procedure or a class. The actual storage for a procedure call or an object is allocated at run time, when the procedure is called or the object is created. As we examine local declarations at compile time, we can, however, lay out *relative addresses*, where the relative address of a name or a component of a data structure is an offset from the start of a data area.

### 6.3.1 Type Expressions

Types have structure, which we shall represent using *type expressions*: a type expression is either a basic type or is formed by applying an operator called a *type constructor* to a type expression. The sets of basic types and constructors depend on the language to be checked.

Example 6.8: The array type `int [2] [3]` can be read as "array of 2 arrays of 3 integers each" and written as a type expression `array(2, array(3, integer))`. This type is represented by the tree in Fig. 6.14. The operator *array* takes two parameters, a number and a type. •

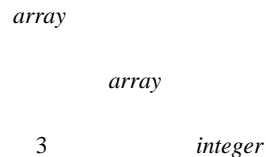

Figure 6.14: Type expression for `int [2] [3]`

We shall use the following definition of type expressions:

- A basic type is a type expression. Typical basic types for a language include *boolean*, *char*, *integer*, *float*, and *void*; the latter denotes "the absence of a value."
- A type name is a type expression.
- A type expression can be formed by applying the array type constructor to a number and a type expression.
- A record is a data structure with named fields. A type expression can be formed by applying the *record* type constructor to the field names and their types. Record types will be implemented in Section 6.3.6 by applying the constructor *record* to a symbol table containing entries for the fields.
- A type expression can be formed by using the type constructor  $\rightarrow$  for function types. We write  $s \rightarrow t$  for "function from type  $s$  to type  $t$ ." Function types will be useful when type checking is discussed in Section 6.5.

## Type Names and Recursive Types

Once a class is defined, its name can be used as a type name in C++ or Java; for example, consider **Node** in the program fragment

```
public class Node { ••• }

public Node n;
```

Names can be used to define recursive types, which are needed for data structures such as linked lists. The pseudocode for a list element

```
class Cell { int info; Cell next; •• } 
```

defines the recursive type **Cell** as a class that contains a field **info** and a field **next** of type **Cell**. Similar recursive types can be defined in C using records and pointers. The techniques in this chapter carry over to recursive types.

- If  $s$  and  $t$  are type expressions, then their Cartesian product  $s \times t$  is a type expression. Products are introduced for completeness; they can be used to represent a list or tuple of types (e.g., for function parameters). We assume that  $\times$  associates to the left and that it has higher precedence than  $\rightarrow$ .
- Type expressions may contain variables whose values are type expressions. Compiler-generated type variables will be used in Section 6.5.4.

A convenient way to represent a type expression is to use a graph. The value-number method of Section 6.1.2, can be adapted to construct a dag for a type expression, with interior nodes for type constructors and leaves for basic types, type names, and type variables; for example, see the tree in Fig. 6.14.<sup>3</sup>

### 6.3.2 Type Equivalence

When are two type expressions equivalent? Many type-checking rules have the form, "if two type expressions are equal then return a certain type else error." Potential ambiguities arise when names are given to type expressions and the names are then used in subsequent type expressions. The key issue is whether a name in a type expression stands for itself or whether it is an abbreviation for another type expression.

<sup>3</sup>Since type names denote type expressions, they can set up implicit cycles; see the box on "Type Names and Recursive Types." If edges to type names are redirected to the type expressions denoted by the names, then the resulting graph can have cycles due to recursive types.

When type expressions are represented by graphs, two types are *structurally equivalent* if and only if one of the following conditions is true:

- They are the same basic type.
- They are formed by applying the same constructor to structurally equivalent types.
- One is a type name that denotes the other.

If type names are treated as standing for themselves, then the first two conditions in the above definition lead to *name equivalence* of type expressions.

Name-equivalent expressions are assigned the same value number, if we use Algorithm 6.3. Structural equivalence can be tested using the unification algorithm in Section 6.5.5.

### 6.3.3 Declarations

We shall study types and declarations using a simplified grammar that declares just one name at a time; declarations with lists of names can be handled as discussed in Example 5.10. The grammar is

$$\begin{array}{lcl}
 D & & T \text{ id } ; D \mid e \\
 T & \rightarrow & B C \mid \text{record } \{ ' D ' \} \\
 B & \rightarrow & \text{int} \mid \text{float} \\
 C & & e \mid [ \text{num} ] C
 \end{array}$$

The fragment of the above grammar that deals with basic and array types was used to illustrate inherited attributes in Section 5.3.2. The difference in this section is that we consider storage layout as well as types.

Nonterminal  $D$  generates a sequence of declarations. Nonterminal  $T$  generates basic, array, or record types. Nonterminal  $B$  generates one of the basic types `int` and `float`. Nonterminal  $C$ , for "component," generates strings of zero or more integers, each integer surrounded by brackets. An array type consists of a basic type specified by  $B$ , followed by array components specified by nonterminal  $C$ . A record type (the second production for  $T$ ) is a sequence of declarations for the fields of the record, all surrounded by curly braces.

### 6.3.4 Storage Layout for Local Names

From the type of a name, we can determine the amount of storage that will be needed for the name at run time. At compile time, we can use these amounts to assign each name a relative address. The type and relative address are saved in the symbol-table entry for the name. Data of varying length, such as strings, or data whose size cannot be determined until run time, such as dynamic arrays, is handled by reserving a known fixed amount of storage for a pointer to the data. Run-time storage management is discussed in Chapter 7.

## Address Alignment

The storage layout for data objects is strongly influenced by the addressing constraints of the target machine. For example, instructions to add integers may expect integers to be *aligned*, that is, placed at certain positions in memory such as an address divisible by 4. Although an array of ten characters needs only enough bytes to hold ten characters, a compiler may therefore allocate 12 bytes — the next multiple of 4 — leaving 2 bytes unused. Space left unused due to alignment considerations is referred to as *padding*. When space is at a premium, a compiler may *pack* data so that no padding is left; additional instructions may then need to be executed at run time to position packed data so that it can be operated on as if it were properly aligned.

Suppose that storage comes in blocks of contiguous bytes, where a byte is the smallest unit of addressable memory. Typically, a byte is eight bits, and some number of bytes form a machine word. Multibyte objects are stored in consecutive bytes and given the address of the first byte.

The *width* of a type is the number of storage units needed for objects of that type. A basic type, such as a character, integer, or float, requires an integral number of bytes. For easy access, storage for aggregates such as arrays and classes is allocated in one contiguous block of bytes.<sup>4</sup>

The translation scheme (SDT) in Fig. 6.15 computes types and their widths for basic and array types; record types will be discussed in Section 6.3.6. The SDT uses synthesized attributes *type* and *width* for each nonterminal and two variables *t* and *w* to pass type and width information from a *B* node in a parse tree to the node for the production  $C \rightarrow e$ . In a syntax-directed definition, *t* and *w* would be inherited attributes for *C*.

The body of the T-production consists of nonterminal *B*, an action, and nonterminal *C*, which appears on the next line. The action between *B* and *C* sets *t* to *B.type* and *w* to *B.width*. If  $B \rightarrow \text{int}$  then *B.type* is set to *integer* and *B.width* is set to 4, the width of an integer. Similarly, if  $B \rightarrow \text{float}$  then *B.type* is *float* and *B.width* is 8, the width of a float.

The productions for *C* determine whether *T* generates a basic type or an array type. If  $C \rightarrow e$ , then *t* becomes *C.type* and *w* becomes *C.width*.

Otherwise, *C* specifies an array component. The action for  $C \rightarrow [\text{num}] C \setminus$  forms *C.type* by applying the type constructor *array* to the operands *num.value* and *C.type*. For instance, the result of applying *array* might be a tree structure such as Fig. 6.14.

<sup>4</sup>Storage allocation for pointers in C and C++ is simpler if all pointers have the same width. The reason is that the storage for a pointer may need to be allocated before we learn the type of the objects it can point to.

```

T -> B          { t = B.type; w = B.width; }
      C

B   int          { B.type = integer; B.width = 4 }
B   float        { B.type = float; B.width = 8; }
C   e            { C.type = t; C.width = w; }
C -+ [ num ] C  { array(mim.value, C.type);
                  C.width = num.value x C.y.width; }

```

Figure 6.15: Computing types and their widths

The width of an array is obtained by multiplying the width of an element by the number of elements in the array. If addresses of consecutive integers differ by 4, then address calculations for an array of integers will include multiplications by 4. Such multiplications provide opportunities for optimization, so it is helpful for the front end to make them explicit. In this chapter, we ignore other machine dependencies such as the alignment of data objects on word boundaries.

Example 6.9: The parse tree for the type `int [2] [3]` is shown by dotted lines in Fig. 6.16. The solid lines show how the type and width are passed from `B`, down the chain of `C`'s through variables `t` and `w`, and then back up the chain as synthesized attributes `type` and `width`. The variables `t` and `w` are assigned the values of `B.type` and `B.width`, respectively, before the subtree with the `C` nodes is examined. The values of `t` and `w` are used at the node for `C`  $\rightarrow$  `e` to start the evaluation of the synthesized attributes up the chain of `C` nodes. •

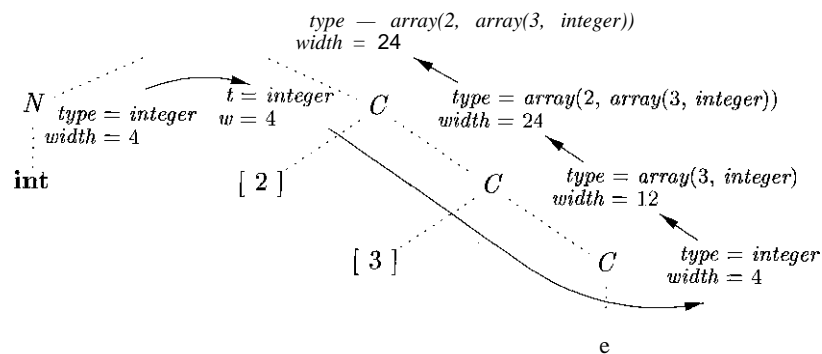

Figure 6.16: Syntax-directed translation of array types

### 6.3.5 Sequences of Declarations

Languages such as C and Java allow all the declarations in a single procedure to be processed as a group. The declarations may be distributed within a Java procedure, but they can still be processed when the procedure is analyzed. Therefore, we can use a variable, say *offset*, to keep track of the next available relative address.

The translation scheme of Fig. 6.17 deals with a sequence of declarations of the form  $T \text{ id}$ , where  $T$  generates a type as in Fig. 6.15. Before the first declaration is considered, *offset* is set to 0. As each new name  $x$  is seen,  $x$  is entered into the symbol table with its relative address set to the current value of *offset*, which is then incremented by the width of the type of  $x$ .

$$\begin{array}{l}
 P \qquad \qquad \{ \text{offset} = 0; \} \\
 \qquad \qquad D \\
 D \rightarrow \bullet T \text{ id} ; \quad \{ \text{top.put}(d.\text{lexeme}, T.\text{type}, \text{offset}); \\
 \qquad \qquad \qquad \text{offset} = \text{offset} + T.\text{width}; \} \\
 \\
 D \rightarrow e
 \end{array}$$

Figure 6.17: Computing the relative addresses of declared names

The semantic action within the production  $D \rightarrow T \text{ id} ; D$  creates a symbol-table entry by executing  $\text{top.put}(id.\text{lexeme}, T.\text{type}, \text{offset})$ . Here *top* denotes the current symbol table. The method *top.put* creates a symbol-table entry for *id.lexeme*, with type *T.type* and relative address *offset* in its data area.

The initialization of *offset* in Fig. 6.17 is more evident if the first production appears on one line as:

$$P \qquad \{ \text{offset} = 0; \} D \qquad (6.1)$$

Nonterminals generating  $e$ , called marker nonterminals, can be used to rewrite productions so that all actions appear at the ends of right sides; see Section 5.5.4. Using a marker nonterminal  $M$ , (6.1) can be restated as:

$$\begin{array}{l}
 P \rightarrow M D \\
 \\
 M \rightarrow e \qquad \{ \text{offset} = 0; \}
 \end{array}$$

### 6.3.6 Fields in Records and Classes

The translation of declarations in Fig. 6.17 carries over to fields in records and classes. Record types can be added to the grammar in Fig. 6.15 by adding the following production

$$T \rightarrow \text{record } \{ ' D ' \}$$

The fields in this record type are specified by the sequence of declarations generated by  $D$ . The approach of Fig. 6.17 can be used to determine the types and relative addresses of fields, provided we are careful about two things:

- The field names within a record must be distinct; that is, a name may appear at most once in the declarations generated by  $D$ .
- The offset or relative address for a field name is relative to the data area for that record.

**Example 6.10:** The use of a name  $x$  for a field within a record does not conflict with other uses of the name outside the record. Thus, the three uses of  $x$  in the following declarations are distinct and do not conflict with each other:

```
float x;
record { float x; float y; } p;
record { int tag; float x; float y; } q;
```

A subsequent assignment  $x = p.x + q.x$ ; sets variable  $x$  to the sum of the fields named  $x$  in the records  $p$  and  $q$ . Note that the relative address of  $x$  in  $p$  differs from the relative address of  $x$  in  $q$ . •

For convenience, record types will encode both the types and relative addresses of their fields, using a symbol table for the record type. A record type has the form  $record(t)$ , where  $record$  is the type constructor, and  $t$  is a symbol-table object that holds information about the fields of this record type.

The translation scheme in Fig. 6.18 consists of a single production to be added to the productions for  $T$  in Fig. 6.15. This production has two semantic actions. The embedded action before  $D$  saves the existing symbol table, denoted by  $top$  and sets  $top$  to a fresh symbol table. It also saves the current  $offset$ , and sets  $offset$  to 0. The declarations generated by  $D$  will result in types and relative addresses being put in the fresh symbol table. The action after  $D$  creates a record type using  $top$ , before restoring the saved symbol table and offset.

$$T \rightarrow \bullet \text{ record } \quad \{ \text{Env.push}(top); \text{top} = \text{new Env}Q; \\ \text{Stack.push}(offset); \text{offset} = 0; \}$$

$$D \text{ '}' \quad \{ T.type = \text{record}(top); T.width = \text{offset}; \\ \text{top} = \text{Env.pop}Q; \text{offset} = \text{Stack.pop}Q; \}$$

Figure 6.18: Handling of field names in records

For concreteness, the actions in Fig. 6.18 give pseudocode for a specific implementation. Let class  $Env$  implement symbol tables. The call  $Env.push(top)$  pushes the current symbol table denoted by  $top$  onto a stack. Variable  $top$  is then set to a new symbol table. Similarly,  $offset$  is pushed onto a stack called  $Stack$ . Variable  $offset$  is then set to 0.



After the declarations in  $D$  have been translated, the symbol table  $top$  holds the types and relative addresses of the fields in this record. Further,  $offset$  gives the storage needed for all the fields. The second action sets  $T.type$  to  $record(top)$  and  $T.width$  to  $offset$ . Variables  $top$  and  $offset$  are then restored to their pushed values to complete the translation of this record type.

This discussion of storage for record types carries over to classes, since no storage is reserved for methods. See Exercise 6.3.2.

### 6.3.7 Exercises for Section 6.3

Exercise 6.3.1: Determine the types and relative addresses for the identifiers in the following sequence of declarations:

```
float x;
record { float x; float y; } p;
record { int tag; float x; float y; } q;
```

! Exercise 6.3.2: Extend the handling of field names in Fig. 6.18 to classes and single-inheritance class hierarchies.

- a) Give an implementation of class *Env* that allows linked symbol tables, so that a subclass can either redefine a field name or refer directly to a field name in a superclass.
- b) Give a translation scheme that allocates a contiguous data area for the fields in a class, including inherited fields. Inherited fields must maintain the relative addresses they were assigned in the layout for the superclass.

## 6.4 Translation of Expressions

The rest of this chapter explores issues that arise during the translation of expressions and statements. We begin in this section with the translation of expressions into three-address code. An expression with more than one operator, like  $a + b * c$ , will translate into instructions with at most one operator per instruction. An array reference  $A[i][j]$  will expand into a sequence of three-address instructions that calculate an address for the reference. We shall consider type checking of expressions in Section 6.5 and the use of boolean expressions to direct the flow of control through a program in Section 6.6.

### 6.4.1 Operations Within Expressions

The syntax-directed definition in Fig. 6.19 builds up the three-address code for an assignment statement  $S$  using attribute *code* for  $S$  and attributes *addr* and *code* for an expression  $E$ . Attributes  $S.code$  and  $E.code$  denote the three-address code for  $S$  and  $E$ , respectively. Attribute  $E.addr$  denotes the address that will

PRODUCTION	SEMANTIC RULES
$S \rightarrow \mathbf{id} = E \ v$	$S.code = E.code \ \parallel$ $gen(top.get(id.lexeme) \ '=' \ E.addr)$
$E \rightarrow E_i + E_i$	$E.addr = \mathbf{new} \ Temp()$ $E.code = E_i.code \ \parallel \ E_i.code \ \parallel$ $gen(E.addr \ '=' \ E_i.addr '+' \ E_i.addr)$
$E \rightarrow -E_i$	$E.addr = \mathbf{new} \ Temp()$ $E.code = E_i.code \ \parallel$ $gen(E.addr \ '=' \ \mathbf{minus} \ E_i.addr)$
$E \rightarrow (E_i)$	$E.addr = E_i.addr$ $E.code = E_i.code$
$\mathbf{1} \ \mathbf{id}$	$E.addr = top.get(id.lexeme)$ $E.code = \text{---}$

Figure 6.19: Three-address code for expressions

hold the value of  $E$ . Recall from Section 6.2.1 that an address can be a name, a constant, or a compiler-generated temporary.

Consider the last production,  $E \rightarrow \mathbf{id}$ , in the syntax-directed definition in Fig. 6.19. When an expression is a single identifier, say  $x$ , then  $x$  itself holds the value of the expression. The semantic rules for this production define  $E.addr$  to point to the symbol-table entry for this instance of  $\mathbf{id}$ . Let  $top$  denote the current symbol table. Function  $top.get$  retrieves the entry when it is applied to the string representation  $id.lexeme$  of this instance of  $\mathbf{id}$ .  $E.code$  is set to the empty string.

When  $E \rightarrow (E_i)$ , the translation of  $E$  is the same as that of the subexpression  $E_i$ . Hence,  $E.addr$  equals  $E_i.addr$ , and  $E.code$  equals  $E_i.code$ .

The operators  $+$  and unary  $-$  in Fig. 6.19 are representative of the operators in a typical language. The semantic rules for  $E \rightarrow E_1 + E_2$  generate code to compute the value of  $E$  from the values of  $E_1$  and  $E_2$ . Values are computed into newly generated temporary names. If  $E_1$  is computed into  $E_1.addr$  and  $E_2$  into  $E_2.addr$ , then  $E_1 + E_2$  translates into  $t = E_1.addr + E_2.addr$ , where  $t$  is a new temporary name.  $E.addr$  is set to  $t$ . A sequence of distinct temporary names  $t_1, t_2, \dots$  is created by successively executing  $\mathbf{new} \ Temp()$ .

For convenience, we use the notation  $gen(x \ '=' \ y \ '+' \ z)$  to represent the three-address instruction  $x = y + z$ . Expressions appearing in place of variables like  $x$ ,  $y$ , and  $z$  are evaluated when passed to  $gen$ , and quoted strings like are taken literally.<sup>5</sup> Other three-address instructions will be built up similarly

<sup>5</sup>In syntax-directed definitions,  $gen$  builds an instruction and returns it. In translation schemes,  $gen$  builds an instruction and incrementally emits it by putting it into the stream

by applying *gen* to a combination of expressions and strings.

When we translate the production  $E \rightarrow E_1 + E_2$ , the semantic rules in Fig. 6.19 build up *E.code* by concatenating *E<sub>1</sub>.code*, *E<sub>2</sub>.code*, and an instruction that adds the values of *E<sub>1</sub>* and *E<sub>2</sub>*. The instruction puts the result of the addition into a new temporary name for *E*, denoted by *E.addr*.

The translation of  $E \rightarrow -E_1$  is similar. The rules create a new temporary for *E* and generate an instruction to perform the unary minus operation.

Finally, the production  $S \rightarrow \text{id} = E$ ; generates instructions that assign the value of expression *E* to the identifier **id**. The semantic rule for this production uses function *top.get* to determine the address of the identifier represented by **id**, as in the rules for  $E \rightarrow \text{id}$ . *S.code* consists of the instructions to compute the value of *E* into an address given by *E.addr*, followed by an assignment to the address *top.get(id.lexeme)* for this instance of **id**.

Example 6.11: The syntax-directed definition in Fig. 6.19 translates the assignment statement `a = b + - c`; into the three-address code sequence

```

ti = minus c
t2 = b + ti
a = t2

```

•

## 6.4.2 Incremental Translation

Code attributes can be long strings, so they are usually generated incrementally, as discussed in Section 5.5.2. Thus, instead of building up *E.code* as in Fig. 6.19, we can arrange to generate only the new three-address instructions, as in the translation scheme of Fig. 6.20. In the incremental approach, *gen* not only constructs a three-address instruction, it appends the instruction to the sequence of instructions generated so far. The sequence may either be retained in memory for further processing, or it may be output incrementally.

The translation scheme in Fig. 6.20 generates the same code as the syntax-directed definition in Fig. 6.19. With the incremental approach, the *code* attribute is not used, since there is a single sequence of instructions that is created by successive calls to *gen*. For example, the semantic rule for  $E \rightarrow E_1 + E_2$  in Fig. 6.20 simply calls *gen* to generate an add instruction; the instructions to compute *E<sub>1</sub>* into *E<sub>1</sub>.addr* and *E<sub>2</sub>* into *E<sub>2</sub>.addr* have already been generated.

The approach of Fig. 6.20 can also be used to build a syntax tree. The new semantic action for  $E \rightarrow E_1 + E_2$  creates a node by using a constructor, as in

```

E → E1 + E2 {E.addr = new Node("+", E1.addr, E2.addr); }

```

Here, attribute *addr* represents the address of a node rather than a variable or constant.

of generated instructions.

```

S      id = E ;    { gen( top.get(id.lexeme) '-' E.addr) }

E  ->  E1 + E2  { E.addr = new Temp();
                  gen(E.addr '=' E1.addr '+' E2.addr); }

      |  - E1     { E.addr = new Temp();
                  gen(E.addr '=' 'minus' E1.addr); }

      |  ( E1 )   { E.addr = E1.addr; }

      |  id       { E.addr = top.get(d.lexeme); }

```

Figure 6.20: Generating three-address code for expressions incrementally

### 6.4.3 Addressing Array Elements

Array elements can be accessed quickly if they are stored in a block of consecutive locations. In C and Java, array elements are numbered  $0, 1, \dots, n - 1$ , for an array with  $n$  elements. If the width of each array element is  $w$ , then the  $i$ th element of array  $A$  begins in location

$$\text{base} + i \times w \quad (6.2)$$

where  $\text{base}$  is the relative address of the storage allocated for the array. That is,  $\text{base}$  is the relative address of  $A[0]$ .

The formula (6.2) generalizes to two or more dimensions. In two dimensions, we write  $A[i][j]$  in C and Java for element  $i$ , in row  $j$ . Let  $w_r$  be the width of a row and let  $w_e$  be the width of an element in a row. The relative address of  $A[i][j]$  can then be calculated by the formula

$$\text{base} + j \times w_r + i \times w_e \quad (6.3)$$

In  $k$  dimensions, the formula is

$$\text{base} + \sum_{j=1}^{k-1} (z_j \times w_j + i_j \times w_e) + i_k \times w_e \quad (6.4)$$

where  $W_j$ , for  $1 < j < k$ , is the generalization of  $W_i$  and  $w_e$  in (6.3).

Alternatively, the relative address of an array reference can be calculated in terms of the numbers of elements  $r_j$  along dimension  $j$  of the array and the width  $w = W_k$  of a single element of the array. In two dimensions (i.e.,  $k = 2$  and  $w = w_e$ ), the location for  $A[n][i_1]$  is given by

$$\text{base} + (h \times n_1 + i_1) \times w \quad (6.5)$$

In  $k$  dimensions, the following formula calculates the same address as (6.4):

$$\text{base} + ((\dots (z_1 \times n_1 + i_1) \times n_2 + i_2) \dots) \times n_k + i_k \times w \quad (6.6)$$

More generally, array elements need not be numbered starting at 0. In a one-dimensional array, the array elements are numbered  $low, low + 1, \dots, high$  and  $base$  is the relative address of  $A[low]$ . Formula (6.2) for the address of  $A[i]$  is replaced by:

$$base + (i - low) \times w \quad (6.7)$$

The expressions (6.2) and (6.7) can both be rewritten as  $i \times w + c$ , where the subexpression  $c = base - low \times w$  can be precalculated at compile time. Note that  $c = base$  when  $low$  is 0. We assume that  $c$  is saved in the symbol table entry for  $A$ , so the relative address of  $A[i]$  is obtained by simply adding  $i \times w$  to  $c$ .

Compile-time precalculation can also be applied to address calculations for elements of multidimensional arrays; see Exercise 6.4.5. However, there is one situation where we cannot use compile-time precalculation: when the array's size is dynamic. If we do not know the values of  $low$  and  $high$  (or their generalizations in many dimensions) at compile time, then we cannot compute constants such as  $c$ . Then, formulas like (6.7) must be evaluated as they are written, when the program executes.

The above address calculations are based on row-major layout for arrays, which is used in C and Java. A two-dimensional array is normally stored in one of two forms, either *row-major* (row-by-row) or *column-major* (column-by-column). Figure 6.21 shows the layout of a 2 x 3 array  $A$  in (a) row-major form and (b) column-major form. Column-major form is used in the Fortran family of languages.

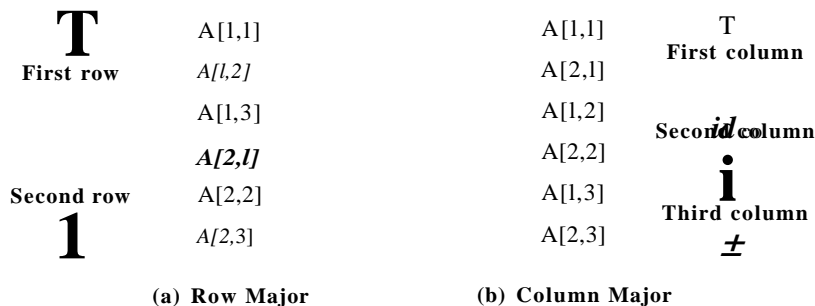

Figure 6.21: Layouts for a two-dimensional array.

We can generalize row- or column-major form to many dimensions. The generalization of row-major form is to store the elements in such a way that, as we scan down a block of storage, the rightmost subscripts appear to vary fastest, like the numbers on an odometer. Column-major form generalizes to the opposite arrangement, with the leftmost subscripts varying fastest.

### 6.4.4 Translation of Array References

The chief problem in generating code for array references is to relate the address-calculation formulas in Section 6.4.3 to a grammar for array references. Let nonterminal  $L$  generate an array name followed by a sequence of index expressions:

$$L \rightarrow L [ E ] \mid \text{id} [ E ]$$

As in C and Java, assume that the lowest-numbered array element is 0. Let us calculate addresses based on widths, using the formula (6.4), rather than on numbers of elements, as in (6.6). The translation scheme in Fig. 6.22 generates three-address code for expressions with array references. It consists of the productions and semantic actions from Fig. 6.20, together with productions involving nonterminal  $L$ .

```

S  ->  id = E ;      { gen(top.get(\d.lexeme) '=' E.addr); }

      |  L = E ;      { gen(L.addr.base '[' L.addr ']' '=' E.addr); }

E   Ei + E2          { E.addr = new TempQ;
                      gen(E.addr '=' Ei.addr '+' E2.addr); }

      |  id           { E.addr = top.get(\d.lexeme); }

                      { E.addr = new Temp ();
                      gen(E.addr '-' L.array.base[' L.addr']'); }

L  ->  id [ E ]      { L.array = top.get(id.lexeme);
                      L.type = L.array.type, elem;
                      L.addr = new TempQ;
                      gen(L.addr '=' E.addr '*' L.type.width); }

      ^  I E1         { L.array = L1.array;
                      L.type = L1.type, elem;
                      t = new Temp ();
                      L.addr = new Temp ();
                      gen(t '=' E1.addr '*' L.type.width); }
                      gen(L.addr '=' L1.addr '+' t); }

```

Figure 6.22: Semantic actions for array references

Nonterminal  $L$  has three synthesized attributes:

1.  $L.addr$  denotes a temporary that is used while computing the offset for the array reference by summing the terms  $ij \times W_j$  in (6.4).

2.  $L.array$  is a pointer to the symbol-table entry for the array name. The base address of the array, say,  $L.array.base$  is used to determine the actual  $r$ -value of an array reference after all the index expressions are analyzed.
3.  $L.type$  is the type of the subarray generated by  $L$ . For any type  $t$ , we assume that its width is given by  $t.width$ . We use types as attributes, rather than widths, since types are needed anyway for type checking. For any array type  $t$ , suppose that  $t.elem$  gives the element type.

The production  $S \rightarrow \mathbf{id} = E;$  represents an assignment to a nonarray variable, which is handled as usual. The semantic action for  $S \rightarrow L = E;$  generates an indexed copy instruction to assign the value denoted by expression  $E$  to the location denoted by the array reference  $L$ . Recall that attribute  $L.array$  gives the symbol-table entry for the array. The array's base address — the address of its 0th element — is given by  $L.array.base$ . Attribute  $L.addr$  denotes the temporary that holds the offset for the array reference generated by  $L$ . The location for the array reference is therefore  $L.array.base[L.addr]$ . The generated instruction copies the  $r$ -value from address  $E.addr$  into the location for  $L$ .

Productions  $E \rightarrow E_i + E_j$  and  $E \rightarrow \mathbf{id}$  are the same as before. The semantic action for the new production  $E \rightarrow L$  generates code to copy the value from the location denoted by  $L$  into a new temporary. This location is  $L.array.base[L.addr]$ , as discussed above for the production  $S \rightarrow L = E;$ . Again, attribute  $L.array$  gives the array name, and  $L.array.base$  gives its base address. Attribute  $L.addr$  denotes the temporary that holds the offset. The code for the array reference places the  $r$ -value at the location designated by the base and offset into a new temporary denoted by  $E.addr$ .

**Example 6.12:** Let  $a$  denote a  $2 \times 3$  array of integers, and let  $c$ ,  $i$ , and  $j$  all denote integers. Then, the type of  $a$  is  $array(2, array(S, integer))$ . Its width  $w$  is 24, assuming that the width of an integer is 4. The type of  $a[i]$  is  $array(3, integer)$ , of width  $w = 12$ . The type of  $a[i][j]$  is  $integer$ .

An annotated parse tree for the expression  $c + a[i][j]$  is shown in Fig. 6.23. The expression is translated into the sequence of three-address instructions in Fig. 6.24. As usual, we have used the name of each identifier to refer to its symbol-table entry. •

## 6.4.5 Exercises for Section 6.4

**Exercise 6.4.1:** Add to the translation of Fig. 6.19 rules for the following productions:

- a)  $E \rightarrow E_i * E_j$ .
- b)  $E \rightarrow \bullet + E_i$  (unary plus).

**Exercise 6.4.2:** Repeat Exercise 6.4.1 for the incremental translation of Fig. 6.20.

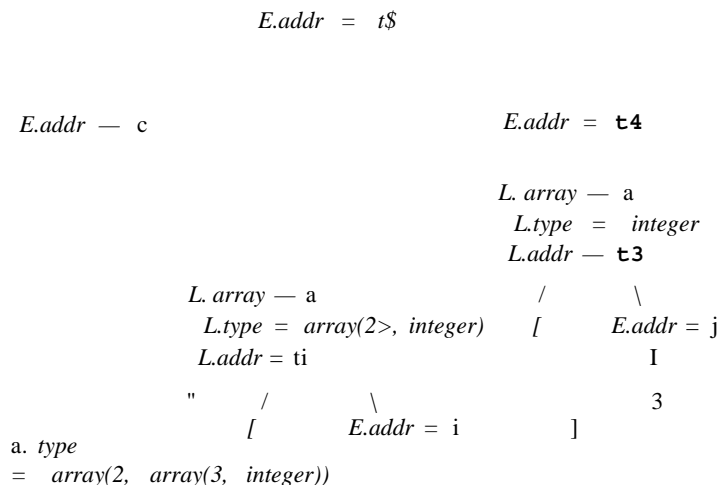
Figure 6.23: Annotated parse tree for  $c + a[i][j]$ 

$$\begin{array}{l}
 t_1 = i * 12 \\
 t_2 = j * 4 \\
 t_3 = t_1 + t_2 \\
 t_4 = a [ t_3 ] \\
 t_5 = c + t_4
 \end{array}$$
Figure 6.24: Three-address code for expression  $c + a[i][j]$ 

**Exercise 6.4.3:** Use the translation of Fig. 6.22 to translate the following assignments:

- a)  $x = a[i] + b[j]$ .
- b)  $x = a[i][j] + b[i][j]$ .
- ! c)  $x = a[b[i][j]][c[k]]$ .

**! Exercise 6.4.4:** Revise the translation of Fig. 6.22 for array references of the Fortran style, that is,  $d[E_1, E_2, \dots, E_n]$  for an  $n$ -dimensional array.

**Exercise 6.4.5:** Generalize formula (6.7) to multidimensional arrays, and indicate what values can be stored in the symbol table and used to compute offsets. Consider the following cases:

- a) An array  $A$  of two dimensions, in row-major form. The first dimension has indexes running from  $l_1$  to  $h_1$ , and the second dimension has indexes from  $l_2$  to  $h_2$ . The width of a single array element is  $w$ .



## Symbolic Type Widths

The intermediate code should be relatively independent of the target machine, so the optimizer does not have to change much if the code generator is replaced by one for a different machine. However, as we have described the calculation of type widths, an assumption regarding how basic types is built into the translation scheme. For instance, Example 6.12 assumes that each element of an integer array takes four bytes. Some intermediate codes, e.g., P-code for Pascal, leave it to the code generator to fill in the size of array elements, so the intermediate code is independent of the size of a machine word. We could have done the same in our translation scheme if we replaced 4 (as the width of an integer) by a symbolic constant.

- b) The same as (a), but with the array stored in column-major form.
- ! c) An array  $A$  of  $k$  dimensions, stored in row-major form, with elements of size  $w$ . The  $j$ th. dimension has indexes running from  $l_j$  to  $h_j$ .
- ! d) The same as (c) but with the array stored in column-major form.

**Exercise 6.4.6:** An integer array  $A[i, j]$  has index  $i$  ranging from 1 to 10 and index  $j$  ranging from 1 to 20. Integers take 4 bytes each. Suppose array  $A$  is stored starting at byte 0. Find the location of:

- a)  $A[4,5]$    b)  $A[10,8]$    c)  $A[3,17]$ .

**Exercise 6.4.7:** Repeat Exercise 6.4.6 if  $A$  is stored in column-major order.

**Exercise 6.4.8:** A real array  $A[i, j, k]$  has index  $i$  ranging from 1 to 4, index  $j$  ranging from 0 to 4, and index  $k$  ranging from 5 to 10. Reals take 8 bytes each. Suppose array  $A$  is stored starting at byte 0. Find the location of:

- a)  $A[3,4,5]$    b)  $A[1,2,7]$    c)  $A[4,3,9]$ .

**Exercise 6.4.9:** Repeat Exercise 6.4.8 if  $A$  is stored in column-major order.

## 6.5 Type Checking

To do *type checking* a compiler needs to assign a type expression to each component of the source program. The compiler must then determine that these type expressions conform to a collection of logical rules that is called the *type system* for the source language.

Type checking has the potential for catching errors in programs. In principle, any check can be done dynamically, if the target code carries the type of an

element along with the value of the element. A *sound* type system eliminates the need for dynamic checking for type errors, because it allows us to determine statically that these errors cannot occur when the target program runs. An implementation of a language is *strongly typed* if a compiler guarantees that the programs it accepts will run without type errors.

Besides their use for compiling, ideas from type checking have been used to improve the security of systems that allow software modules to be imported and executed. Java programs compile into machine-independent bytecodes that include detailed type information about the operations in the bytecodes. Imported code is checked before it is allowed to execute, to guard against both inadvertent errors and malicious misbehavior.

### 6.5.1 Rules for Type Checking

Type checking can take on two forms: synthesis and inference. *Type synthesis* builds up the type of an expression from the types of its subexpressions. It requires names to be declared before they are used. The type of  $E_1 + E_2$  is defined in terms of the types of  $E_1$  and  $E_2$ . A typical rule for type synthesis has the form

$$\begin{array}{l} \text{if } f \text{ has type } s \rightarrow t \text{ and } x \text{ has type } s, \\ \text{then expression } f(x) \text{ has type } t \end{array} \quad \frac{}{s \rightarrow t} \wedge$$

Here,  $f$  and  $x$  denote expressions, and  $s \rightarrow t$  denotes a function from  $s$  to  $t$ . This rule for functions with one argument carries over to functions with several arguments. The rule (6.8) can be adapted for  $E_1 + E_2$  by viewing it as a function application  $add(E_1, E_2)$ .

*Type inference* determines the type of a language construct from the way it is used. Looking ahead to the examples in Section 6.5.4, let *null* be a function that tests whether a list is empty. Then, from the usage  $null(x)$ , we can tell that  $x$  must be a list. The type of the elements of  $x$  is not known; all we know is that  $x$  must be a list of elements of some type that is presently unknown.

Variables representing type expressions allow us to talk about unknown types. We shall use Greek letters  $\alpha, \beta, \dots$  for type variables in type expressions.

A typical rule for type inference has the form

$$\begin{array}{l} \text{if } f(x) \text{ is an expression,} \\ \text{then for some } \alpha \text{ and } \beta, f \text{ has type } \alpha \rightarrow \beta \text{ and } x \text{ has type } \alpha \end{array} \quad \frac{}{\alpha \rightarrow \beta} \wedge$$

Type inference is needed for languages like ML, which check types, but do not require names to be declared.

We shall use the term "synthesis" even if some context information is used to determine types. With overloaded functions, where the same name is given to more than one function, the context of  $E_1 + E_2$  may also need to be considered in some languages.

In this section, we consider type checking of expressions. The rules for checking statements are similar to those for expressions. For example, we treat the conditional statement "if( $E$ )  $S$ ;" as if it were the application of a function  $if$  to  $E$  and  $S$ . Let the special type *void* denote the absence of a value. Then function  $if$  expects to be applied to a *boolean* and a *void*; the result of the application is a *void*.

## 6.5.2 Type Conversions

Consider expressions like  $x + i$ , where  $x$  is of type float and  $i$  is of type integer. Since the representation of integers and floating-point numbers is different within a computer and different machine instructions are used for operations on integers and floats, the compiler may need to convert one of the operands of  $+$  to ensure that both operands are of the same type when the addition occurs.

Suppose that integers are converted to floats when necessary, using a unary operator (float). For example, the integer **2** is converted to a float in the code for the expression **2\*3.14**:

```
ti = (float) 2
ti = ti * 3.14
```

We can extend such examples to consider integer and float versions of the operators; for example, `int*` for integer operands and `float*` for floats.

Type synthesis will be illustrated by extending the scheme in Section 6.4.2 for translating expressions. We introduce another attribute  $E.type$ , whose value is either *integer* or *float*. The rule associated with  $E \rightarrow E_1 + E_2$  builds on the pseudocode

```
if (  $E_1.type = integer$  and  $E_2.type = integer$  )  $E.type = integer$ ,
else if (  $E_1.type = float$  and  $E_2.type = integer$  ) •••
```

As the number of types subject to conversion increases, the number of cases increases rapidly. Therefore with large numbers of types, careful organization of the semantic actions becomes important.

Type conversion rules vary from language to language. The rules for Java in Fig. 6.25 distinguish between *widening* conversions, which are intended to preserve information, and *narrowing* conversions, which can lose information. The widening rules are given by the hierarchy in Fig. 6.25(a): any type lower in the hierarchy can be widened to a higher type. Thus, a *char* can be widened to an *int* or to a *float*, but a *char* cannot be widened to a *short*. The narrowing rules are illustrated by the graph in Fig. 6.25(b): a type  $s$  can be narrowed to a type  $t$  if there is a path from  $s$  to  $t$ . Note that *char*, *short*, and *byte* are pairwise convertible to each other.

Conversion from one type to another is said to be *implicit* if it is done automatically by the compiler. Implicit type conversions, also called *coercions*,

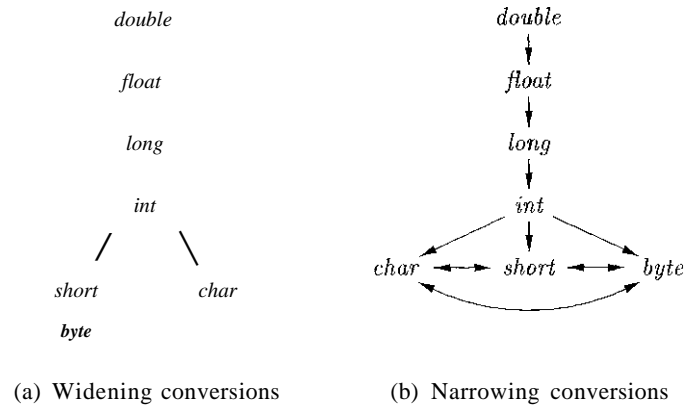

Figure 6.25: Conversions between primitive types in Java

are limited in many languages to widening conversions. Conversion is said to be *explicit* if the programmer must write something to cause the conversion. Explicit conversions are also called *casts*.

The semantic action for checking  $E \rightarrow E_1 + E_2$  uses two functions:

1.  $\text{max}(t_1, t_2)$  takes two types  $t_1$  and  $t_2$  and returns the maximum (or least upper bound) of the two types in the widening hierarchy. It declares an error if either  $t_1$  or  $t_2$  is not in the hierarchy; e.g., if either type is an array or a pointer type.
2.  $\text{widen}(a, t, w)$  generates type conversions if needed to widen an address  $a$  of type  $t$  into a value of type  $w$ . It returns  $a$  itself if  $t$  and  $w$  are the same type. Otherwise, it generates an instruction to do the conversion and place the result in a temporary  $t$ , which is returned as the result. Pseudocode for  $\text{widen}$ , assuming that the only types are *integer* and *float*, appears in Fig. 6.26.

```

Addr widen(Addr a, Type t, Type w)
  if ( t = w ) return a;
  else if ( t = integer and w = float ) {
    temp ← new TempQ;
    gen(temp '=' '(float)' a);
    return temp;
  }
  else error;
}

```

Figure 6.26: Pseudocode for function *widen*

The semantic action for  $E \rightarrow E_1 + E_2$  in Fig. 6.27 illustrates how type conversions can be added to the scheme in Fig. 6.20 for translating expressions. In the semantic action, temporary variable  $a_1$  is either  $E_1.addr$ , if the type of  $E_1$  does not need to be converted to the type of  $E$ , or a new temporary variable returned by *widen* if this conversion is necessary. Similarly,  $a_2$  is either  $E_2.addr$  or a new temporary holding the type-converted value of  $E_2$ . Neither conversion is needed if both types are *integer* or both are *float*. In general, however, we could find that the only way to add values of two different types is to convert them both to a third type.

```

E → E1 + E2   { E.type = max(E1.type, E2.type);
                  ai = widen(E1.addr, E1.type, E.type);
                  a2 = widen(E2.addr, E2.type, E.type);
                  E.addr = new Temp ();
                  gen(E.addr ← ai '+' a2); }

```

Figure 6.27: Introducing type conversions into expression evaluation

### 6.5.3 Overloading of Functions and Operators

An *overloaded* symbol has different meanings depending on its context. Overloading is *resolved* when a unique meaning is determined for each occurrence of a name. In this section, we restrict attention to overloading that can be resolved by looking only at the arguments of a function, as in Java.

Example 6.13: The  $+$  operator in Java denotes either string concatenation or addition, depending on the types of its operands. User-defined functions can be overloaded as well, as in

```

void err() { ... }
void err(String s) { ... }

```

Note that we can choose between these two versions of a function *err* by looking at their arguments. •

The following is a type-synthesis rule for overloaded functions:

```

if / can have type  $S_i \rightarrow U$ , for  $1 < i < n$ , where  $S_i \wedge S_j$  for  $i \wedge j$ 
and  $x$  has type  $S_k$ , for some  $1 < k < n$ 
then expression  $f(x)$  has type  $tu$ 

```

(6.10)

The value-number method of Section 6.1.2 can be applied to type expressions to resolve overloading based on argument types, efficiently. In a DAG representing a type expression, we assign an integer index, called a value number, to each node. Using Algorithm 6.3, we construct a signature for a node,

consisting of its label and the value numbers of its children, in order from left to right. The signature for a function consists of the function name and the types of its arguments. The assumption that we can resolve overloading based on the types of arguments is equivalent to saying that we can resolve overloading based on signatures.

It is not always possible to resolve overloading by looking only at the arguments of a function. In Ada, instead of a single type, a subexpression standing alone may have a set of possible types for which the context must provide sufficient information to narrow the choice down to a single type (see Exercise 6.5.2).

### 6.5.4 Type Inference and Polymorphic Functions

Type inference is useful for a language like ML, which is strongly typed, but does not require names to be declared before they are used. Type inference ensures that names are used consistently.

The term "polymorphic" refers to any code fragment that can be executed with arguments of different types. In this section, we consider *parametric polymorphism*, where the polymorphism is characterized by parameters or type variables. The running example is the ML program in Fig. 6.28, which defines a function *length*. The type of *length* can be described as, "for any type *a*, *length* maps a list of elements of type *a* to an integer."

```
fun length(x) =
  if null(x) then 0 else length(tl(x)) + 1;
```

Figure 6.28: ML program for the length of a list

Example 6.14: In Fig. 6.28, the keyword *fun* introduces a function definition; functions can be recursive. The program fragment defines function *length* with one parameter *x*. The body of the function consists of a conditional expression. The predefined function *null* tests whether a list is empty, and the predefined function *tl* (short for "tail") returns the remainder of a list after the first element is removed.

The function *length* determines the length or number of elements of a list *x*. All elements of a list must have the same type, but *length* can be applied to lists whose elements are of any one type. In the following expression, *length* is applied to two different types of lists (list elements are enclosed within "[" and "]"):

$$\text{length}(["sun", "mon", "tue"]) + \text{length}([10,9,8, 7]) \quad (6.11)$$

The list of strings has length 3 and the list of integers has length 4, so expression (6.11) evaluates to 7. •

Using the symbol  $\forall$  (read as "for any type") and the type constructor *list*, the type of *length* can be written as

$$\forall t. \text{list}(t) \rightarrow \text{integer} \quad (6.12)$$

The  $\forall$  symbol is the *universal quantifier*, and the type variable to which it is applied is said to be *bound* by it. Bound variables can be renamed at will, provided all occurrences of the variable are renamed. Thus, the type expression

$$\forall ?t. \text{list}(f3) \rightarrow \text{integer}$$

is equivalent to (6.12). A type expression with a  $\forall$  symbol in it will be referred to informally as a "polymorphic type."

Each time a polymorphic function is applied, its bound type variables can denote a different type. During type checking, at each use of a polymorphic type we replace the bound variables by fresh variables and remove the universal quantifiers.

The next example informally infers a type for *length*, implicitly using type inference rules like (6.9), which is repeated here:

if  $f(x)$  is an expression,  
then for some  $a$  and  $/3$ ,  $/$  has type  $a \rightarrow /3$  and  $x$  has type  $a$

Example 6.15 : The abstract syntax tree in Fig. 6.29 represents the definition of *length* in Fig. 6.28. The root of the tree, labeled *fun*, represents the function definition. The remaining nonleaf nodes can be viewed as function applications. The node labeled  $\div$  represents the application of the operator  $\div$  to a pair of children. Similarly, the node labeled *if* represents the application of an operator *if* to a triple formed by its children (for type checking, it does not matter that either the then or the else part will be evaluated, but not both).

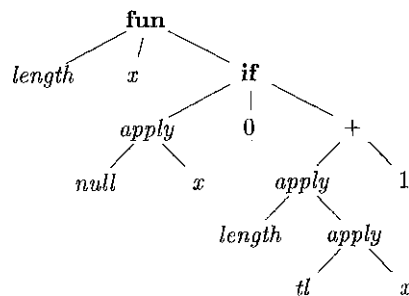

Figure 6.29: Abstract syntax tree for the function definition in Fig. 6.28

From the body of function *length*, we can infer its type. Consider the children of the node labeled *if*, from left to right. Since *null* expects to be applied to lists,  $x$  must be a list. Let us use variable  $a$  as a placeholder for the type of the list elements; that is,  $x$  has type "list of  $a$ ."

## Substitutions, Instances, and Unification

If  $t$  is a type expression and  $S$  is a substitution (a mapping from type variables to type expressions), then we write  $S(t)$  for the result of consistently replacing all occurrences of each type variable  $a$  in  $t$  by  $S(a)$ .  $S(t)$  is called an *instance* of  $t$ . For example,  $list(integer)$  is an instance of  $list(a)$ , since it is the result of substituting  $integer$  for  $a$  in  $list(a)$ . Note, however, that  $integer \rightarrow float$  is not an instance of  $a \rightarrow a$ , since a substitution must replace all occurrences of  $a$  by the same type expression.

Substitution  $S$  is a *unifier* of type expressions  $t_1$  and  $t_2$  if  $S(t_1) = S(t_2)$ .  $S$  is the *most general unifier* of  $t_1$  and  $t_2$  if for any other unifier of  $t_1$  and  $t_2$ , say  $S'$ , it is the case that for any  $t$ ,  $S'(t)$  is an instance of  $S(t)$ . In words,  $S'$  imposes more constraints on  $t$  than  $S$  does.

If  $null(x)$  is true, then  $length(x)$  is 0. Thus, the type of  $length$  must be "function from list of  $a$  to integer." This inferred type is consistent with the usage of  $length$  in the else part,  $length(tl(x)) + 1$ . •

Since variables can appear in type expressions, we have to re-examine the notion of equivalence of types. Suppose  $E \vdash s = s'$  is applied to  $E$ , of type  $t$ . Instead of simply determining the equality of  $s$  and  $t$ , we must "unify" them. Informally, we determine whether  $s$  and  $t$  can be made structurally equivalent by replacing the type variables in  $s$  and  $t$  by type expressions.

A *substitution* is a mapping from type variables to type expressions. We write  $S(t)$  for the result of applying the substitution  $S$  to the variables in type expression  $t$ ; see the box on "Substitutions, Instances, and Unification." Two type expressions  $t_1$  and  $t_2$  *unify* if there exists some substitution  $S$  such that  $S(t_1) = S(t_2)$ . In practice, we are interested in the most general unifier, which is a substitution that imposes the fewest constraints on the variables in the expressions. See Section 6.5.5 for a unification algorithm.

Algorithm 6.16: Type inference for polymorphic functions.

**INPUT:** A program consisting of a sequence of function definitions followed by an expression to be evaluated. An expression is made up of function applications and names, where names can have predefined polymorphic types.

**OUTPUT:** Inferred types for the names in the program.

**METHOD:** For simplicity, we shall deal with unary functions only. The type of a function  $f(x_1, x_2)$  with two parameters can be represented by a type expression  $s_1 \times s_2 \rightarrow t$ , where  $s_1$  and  $s_2$  are the types of  $x_1$  and  $x_2$ , respectively, and  $t$  is the type of the result  $f(x_1, x_2)$ . An expression  $f(a, b)$  can be checked by matching the type of  $a$  with  $s_1$  and the type of  $b$  with  $s_2$ .



Check the function definitions and the expression in the input sequence. Use the inferred type of a function if it is subsequently used in an expression.

- For a function definition  $\text{fun } \text{id}_i(\text{id}_i) = E$ , create fresh type variables  $a$  and  $\beta$ . Associate the type  $a \rightarrow \beta$  with the function  $\text{id}_i$ , and the type  $a$  with the parameter  $\text{id}_i$ . Then, infer a type for expression  $E$ . Suppose  $a$  denotes type  $s$  and  $\beta$  denotes type  $t$  after type inference for  $E$ . The inferred type of function  $\text{id}_i$  is  $s \rightarrow t$ . Bind any type variables that remain unconstrained in  $s \rightarrow t$  by  $\forall$  quantifiers.
- For a function application  $E_1(E_2)$ , infer types for  $E_1$  and  $E_2$ . Since  $E_1$  is used as a function, its type must have the form  $s \rightarrow s'$ . (Technically, the type of  $E_1$  must unify with  $\beta \rightarrow \gamma$ , where  $\beta$  and  $\gamma$  are new type variables). Let  $t$  be the inferred type of  $E_2$ . Unify  $s$  and  $t$ . If unification fails, the expression has a type error. Otherwise, the inferred type of  $E_1(E_2)$  is  $s'$ .
- For each occurrence of a polymorphic function, replace the bound variables in its type by distinct fresh variables and remove the  $\forall$  quantifiers. The resulting type expression is the inferred type of this occurrence.
- For a name that is encountered for the first time, introduce a fresh variable for its type.
- 

Example 6.17: In Fig. 6.30, we infer a type for function *length*. The root of the syntax tree in Fig. 6.29 is for a function definition, so we introduce variables  $\beta$  and  $\gamma$ , associate the type  $\beta \rightarrow \gamma$  with function *length*, and the type  $\beta$  with  $x$ ; see lines 1-2 of Fig. 6.30.

At the right child of the root, we view *if* as a polymorphic function that is applied to a triple, consisting of a boolean and two expressions that represent the then and else parts. Its type is **VCK**.  $\text{boolean} \times a \times a \rightarrow a$ .

Each application of a polymorphic function can be to a different type, so we make up a fresh variable  $a_i$  (where  $i$  is from "if") and remove the  $\forall$ ; see line 3 of Fig. 6.30. The type of the left child of *if* must unify with *boolean*, and the types of its other two children must unify with *on*.

The predefined function *null* has type  $\forall a. \text{list}(a) \rightarrow \text{boolean}$ . We use a fresh type variable  $a_n$  (where  $n$  is for "null") in place of the bound variable  $a$ ; see line 4. From the application of *null* to  $x$ , we infer that the type  $\beta$  of  $x$  must match  $\text{list}(a_n)$ ; see line 5.

At the first child of *if*, the type *boolean* for  $\text{null}(x)$  matches the type expected by *if*. At the second child, the type  $a_n$  unifies with *integer*; see line 6.

Now, consider the subexpression  $\text{length}(\text{tl}(x)) + 1$ . We make up a fresh variable  $a_t$  (where  $t$  is for "tail") for the bound variable  $a$  in the type of *tl*; see line 8. From the application  $\text{tl}(x)$ , we infer  $\text{list}(a_t) = \beta = \text{list}(a_n)$ ; see line 9.

Since  $\text{length}(\text{tl}(x))$  is an operand of  $+$ , its type  $\gamma$  must unify with *integer*; see line 10. It follows that the type of *length* is  $\text{list}(a_n) \rightarrow \text{integer}$ . After the

LINE	EXPRESSION	TYPE	UNIFY
1)	<i>length</i>		
2)	<i>x</i>	↓	
3)	<b>if</b>	<i>boolean x ai x ai → ai</i>	
4)	<i>null</i>	<i>list(a<sub>n</sub>) → boolean</i>	
5)	<i>null(x)</i>	<i>boolean</i>	<i>list(α<sub>n</sub>) = β</i>
6)	<i>0</i>	<i>integer</i>	<i>α<sub>i</sub> = integer</i>
7)	<i>+</i>	<i>integer x integer → integer</i>	
8)	<i>tl</i>	<i>list(at) → list(at)</i>	
9)	<i>tl(x)</i>	<i>list(at)</i>	<i>list(at) list(a<sub>n</sub>)</i>
10)	<i>length(tl(x))</i>	<i>1</i>	<i>7 integer</i>
11)	<i>1</i>	<i>integer</i>	
12)	<i>length(tl(x)) + 1</i>	<i>integer</i>	
13)	<b>if</b> ( ... )	<i>integer</i>	

Figure 6.30: Inferring a type for the function *length* of Fig. 6.28

function definition is checked, the type variable  $a_n$  remains in the type of *length*. Since no assumptions were made about  $a_n$ , any type can be substituted for it when the function is used. We therefore make it a bound variable and write

$$\forall a_n. \text{list}(a_n) \rightarrow \text{integer}$$

for the type of *length*. •

### 6.5.5 An Algorithm for Unification

Informally, unification is the problem of determining whether two expressions  $s$  and  $t$  can be made identical by substituting expressions for the variables in  $s$  and  $t$ . Testing equality of expressions is a special case of unification; if  $s$  and  $t$  have constants but no variables, then  $s$  and  $t$  unify if and only if they are identical. The unification algorithm in this section extends to graphs with cycles, so it can be used to test structural equivalence of circular types.<sup>7</sup>

We shall implement a graph-theoretic formulation of unification, where types are represented by graphs. Type variables are represented by leaves and type constructors are represented by interior nodes. Nodes are grouped into equivalence classes; if two nodes are in the same equivalence class, then the type expressions they represent must unify. Thus, all interior nodes in the same class must be for the same type constructor, and their corresponding children must be equivalent.

**Example 6.18 :** Consider the two type expressions

<sup>7</sup>In some applications, it is an error to unify a variable with an expression containing that variable. Algorithm 6.19 permits such substitutions.

$$\begin{aligned} & ((\mathbf{ai} \quad a_2) \times \text{Ust}(a_2)) \rightarrow \text{Ust}(ct2) \\ & ((as \rightarrow \bullet \mathbf{0:4}) \times \text{list}(a_2)) \rightarrow \bullet \mathbf{0:5} \end{aligned}$$

The following substitution  $\sigma$  is the most general unifier for these expressions

$$\begin{array}{ll} \underline{x} & \underline{S(x)} \\ ai & a.i \\ 0.2 & 0L2 \\ as & cKi \\ a^4 & a_2 \\ a^\wedge & \text{Ust}(a2) \end{array}$$

This substitution maps the two type expressions to the following expression

$$((ax \rightarrow \bullet \mathbf{0:2}) \times \text{list}(cKi)) \rightarrow \text{list}(a2)$$

The two expressions are represented by the two nodes labeled  $\rightarrow: 1$  in Fig. 6.31. The integers at the nodes indicate the equivalence classes that the nodes belong to after the nodes numbered 1 are unified. •

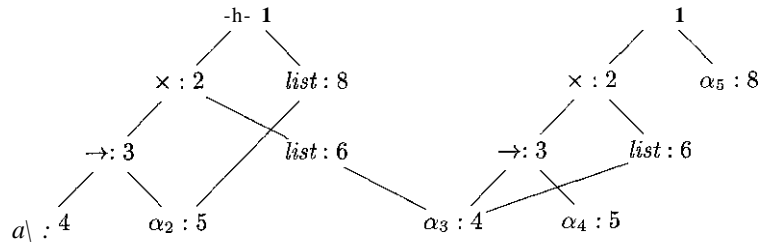

Figure 6.31: Equivalence classes after unification

Algorithm 6.19: Unification of a pair of nodes in a type graph.

**INPUT:** A graph representing a type and a pair of nodes  $m$  and  $n$  to be unified.

**OUTPUT:** Boolean value true if the expressions represented by the nodes  $m$  and  $n$  unify; false, otherwise.

**METHOD:** A node is implemented by a record with fields for a binary operator and pointers to the left and right children. The sets of equivalent nodes are maintained using the *set* field. One node in each equivalence class is chosen to be the unique representative of the equivalence class by making its *set* field contain a null pointer. The *set* fields of the remaining nodes in the equivalence class will point (possibly indirectly through other nodes in the set) to the representative. Initially, each node  $n$  is in an equivalence class by itself, with  $n$  as its own representative node.

The unification algorithm, shown in Fig. 6.32, uses the following two operations on nodes:

```

boolean unify(Node m, Node n) {
    s = find(m); t = find(n);
    if ( s == t ) return true;
    else if ( nodes s and t represent the same basic type ) return true;
    else if ( s is an op-node with children s1 and s2, and
              t is an op-node with children t1 and t2 ) {
        union(s1, t1);
        return unify(s2,t2) and unify(s2,t2);
    }
    else if s or t represents a variable {
        union(s,t);
        return true;
    }
    else return false;
}

```

Figure 6.32: Unification algorithm.

- *find(n)* returns the representative node of the equivalence class currently containing node *n*.
- *union(m, n)* merges the equivalence classes containing nodes *m* and *n*. If one of the representatives for the equivalence classes of *m* and *n* is a non-variable node, *union* makes that nonvariable node be the representative for the merged equivalence class; otherwise, *union* makes one or the other of the original representatives be the new representative. This asymmetry in the specification of *union* is important because a variable cannot be used as the representative for an equivalence class for an expression containing a type constructor or basic type. Otherwise, two inequivalent expressions may be unified through that variable.

The *union* operation on sets is implemented by simply changing the *set* field of the representative of one equivalence class so that it points to the representative of the other. To find the equivalence class that a node belongs to, we follow the *set* pointers of nodes until the representative (the node with a null pointer in the *set* field) is reached.

Note that the algorithm in Fig. 6.32 uses  $s = \text{find}(m)$  and  $t = \text{find}(n)$  rather than  $m$  and  $n$ , respectively. The representative nodes  $s$  and  $t$  are equal if  $m$  and  $n$  are in the same equivalence class. If  $s$  and  $t$  represent the same basic type, the call  $\text{unify}(m, n)$  returns true. If  $s$  and  $t$  are both interior nodes for a binary type constructor, we merge their equivalence classes on speculation and recursively check that their respective children are equivalent. By merging first, we decrease the number of equivalence classes before recursively checking the children, so the algorithm terminates.

The substitution of an expression for a variable is implemented by adding the leaf for the variable to the equivalence class containing the node for that expression. Suppose either  $m$  or  $n$  is a leaf for a variable. Suppose also that this leaf has been put into an equivalence class with a node representing an expression with a type constructor or a basic type. Then *find* will return a representative that reflects that type constructor or basic type, so that a variable cannot be unified with two different expressions. •

Example 6.20: Suppose that the two expressions in Example 6.18 are represented by the initial graph in Fig. 6.33, where each node is in its own equivalence class. When Algorithm 6.19 is applied to compute  $unify(l, 9)$ , it notes that nodes 1 and 9 both represent the same operator. It therefore merges 1 and 9 into the same equivalence class and calls  $unify(2, 10)$  and  $unify(8, 14)$ . The result of computing  $unify(l, 9)$  is the graph previously shown in Fig. 6.31. •

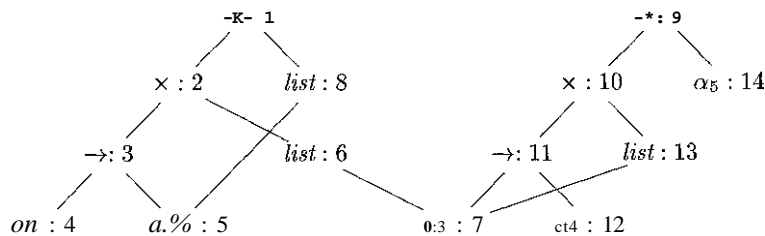

Figure 6.33: Initial graph with each node in its own equivalence class

If Algorithm 6.19 returns true, we can construct a substitution  $S$  that acts as the unifier, as follows. For each variable  $a$ ,  $find(a)$  gives the node  $n$  that is the representative of the equivalence class of  $a$ . The expression represented by  $n$  is  $S(a)$ . For example, in Fig. 6.31, we see that the representative for  $\llbracket 3$  is node 4, which represents  $a$ . The representative for  $a\%$  is node 8, which represents  $list(a, 2)$ . The resulting substitution  $S$  is as in Example 6.18.

### 6.5.6 Exercises for Section 6.5

Exercise 6.5.1: Assuming that function *widen* in Fig. 6.26 can handle any of the types in the hierarchy of Fig. 6.25(a), translate the expressions below. Assume that  $c$  and  $d$  are characters,  $s$  and  $t$  are short integers,  $i$  and  $j$  are integers, and  $f$  is a float.

- $x = s + c$ .
- $i = s + c$ .
- $x = (s + c) * (t + d)$ .

Exercise 6.5.2: As in Ada, suppose that each expression must have a unique type, but that from a subexpression, by itself, all we can deduce is a set of possible types. That is, the application of function  $Ei$  to argument  $E_s$ , represented by  $E \rightarrow Ei (Ei)$ , has the associated rule

$$E.type = \{t \mid \text{for some } s \text{ in } E_s.type, s \rightarrow t \text{ is in } Ei.type \}$$

Describe an SDD that determines a unique type for each subexpression by using an attribute *type* to synthesize a set of possible types bottom-up, and, once the unique type of the overall expression is determined, proceeds top-down to determine attribute *unique* for the type of each subexpression.

## 6.6 Control Flow

The translation of statements such as if-else-statements and while-statements is tied to the translation of boolean expressions. In programming languages, boolean expressions are often used to

1. *Alter the flow of control.* Boolean expressions are used as conditional expressions in statements that alter the flow of control. The value of such boolean expressions is implicit in a position reached in a program. For example, in if ( $E$ )  $S$ , the expression  $E$  must be true if statement  $S$  is reached.
2. *Compute logical values.* A boolean expression can represent *true* Or *false* as values. Such boolean expressions can be evaluated in analogy to arithmetic expressions using three-address instructions with logical operators.

The intended use of boolean expressions is determined by its syntactic context. For example, an expression following the keyword if is used to alter the flow of control, while an expression on the right side of an assignment is used to denote a logical value. Such syntactic contexts can be specified in a number of ways: we may use two different nonterminals, use inherited attributes, or set a flag during parsing. Alternatively we may build a syntax tree and invoke different procedures for the two different uses of boolean expressions.

This section concentrates on the use of boolean expressions to alter the flow of control. For clarity, we introduce a new nonterminal  $B$  for this purpose. In Section 6.6.6, we consider how a compiler can allow boolean expressions to represent logical values.

### 6.6;1 Boolean Expressions

Boolean expressions are composed of the boolean operators (which we denote  $\&\&$ ,  $\mid$ , and  $!$ , using the C convention for the operators AND, OR, and NOT, respectively) applied to elements that are boolean variables or relational expressions. Relational expressions are of the form  $E_x \text{ rel } E_y$ , where  $E_x$  and

$E_i$  are arithmetic expressions. In this section, we consider boolean expressions generated by the following grammar:

$$B \rightarrow B \ \&\& \ | \ B \ \&\& \ B \ | \ ! \ B \ | \ ( \ B \ ) \ \backslash \ E \ \text{rel} \ E \ | \ \text{true} \ | \ \text{false}$$

We use the attribute **rel.op** to indicate which of the six comparison operators  $<$ ,  $<=$ ,  $=$ ,  $!=$ ,  $>$ , or  $>=$  is represented by **rel**. As is customary, we assume that  $\&\&$  and  $\&\&$  are left-associative, and that  $\&\&$  has lowest precedence, then  $\&\&$ , then  $!$ .

Given the expression  $B_i \ \&\& \ B_j$ , if we determine that  $B_i$  is true, then we can conclude that the entire expression is true without having to evaluate  $B_j$ . Similarly, given  $B_i \ \&\& \ B_j$ , if  $B_i$  is false, then the entire expression is false.

The semantic definition of the programming language determines whether all parts of a boolean expression must be evaluated. If the language definition permits (or requires) portions of a boolean expression to go unevaluated, then the compiler can optimize the evaluation of boolean expressions by computing only enough of an expression to determine its value. Thus, in an expression such as  $B_i \ \&\& \ B_j$ , neither  $B_i$  nor  $B_j$  is necessarily evaluated fully. If either  $B_i$  or  $B_j$  is an expression with side effects (e.g., it contains a function that changes a global variable), then an unexpected answer may be obtained.

## 6.6.2 Short-Circuit Code

In *short-circuit* (or *jumping*) code, the boolean operators  $\&\&$ ,  $\&\&$ , and  $!$  translate into jumps. The operators themselves do not appear in the code; instead, the value of a boolean expression is represented by a position in the code sequence.

**Example 6.21:** The statement

```
if ( x < 100 || x > 200 && x != y ) x = 0;
```

might be translated into the code of Fig. 6.34. In this translation, the boolean expression is true if control reaches label  $L_1$ . If the expression is false, control goes immediately to  $L_2$ , skipping  $L_1$ , and the assignment  $x = 0$ . •

```

    if x < 100 goto L1
    ifFalse x > 200 goto L2
    ifFalse x != y goto L2
L1:  x = 0
L2:
```

Figure 6.34: Jumping code

### 6.6.3 Flow-of-Control Statements

We now consider the translation of boolean expressions into three-address code in the context of statements such as those generated by the following grammar:

$$\begin{array}{l} S \quad \text{if } ( B ) \text{ Si} \\ S \quad \rightarrow \quad \text{if } ( B ) \text{ Si else } S_2 \\ S \quad \rightarrow \quad \text{while } ( S ) \text{ Si} \end{array}$$

In these productions, nonterminal  $B$  represents a boolean expression and non-terminal  $S$  represents a statement.

This grammar generalizes the running example of while expressions that we introduced in Example 5.19. As in that example, both  $B$  and  $S$  have a synthesized attribute *code*, which gives the translation into three-address instructions. For simplicity, we build up the translations  $B.code$  and  $S.code$  as strings, using syntax-directed definitions. The semantic rules defining the *code* attributes could be implemented instead by building up syntax trees and then emitting code during a tree traversal, or by any of the approaches outlined in Section 5.5.

The translation of **if** ( $B$ )  $S_i$  consists of  $B.code$  followed by  $S_i.code$ , as illustrated in Fig. 6.35(a). Within  $B.code$  are jumps based on the value of  $B$ . If  $B$  is true, control flows to the first instruction of  $S_i.code$ , and if  $B$  is false, control flows to the instruction immediately following  $S_i.code$ .

	to $B.true$		to $B.true$
$B.code$	to $B.false$	$B.code$	to $B.false$
$B.true$ :	$S_i.code$	$B.true$	$S_i.code$
$B.false$ :		$B.false$	<b>goto</b> $S.next$
(a) if		$S_2.code$	
		$S.next$	
$begin$ :	to $B.true$	$begin$	(b) if-else
$B.code$	to $B.false$		
$B.true$ :		$S_i.code$	
		<b>goto</b> $begin$	
$B.false$ :	(c) while		

Figure 6.35: Code for if-, if-else-, and while-statements

The labels for the jumps in  $B.code$  and  $S.code$  are managed using inherited attributes. With a boolean expression  $B$ , we associate two labels:  $B.true$ , the



label to which control flows if  $B$  is true, and  $B.false$ , the label to which control flows if  $B$  is false. With a statement  $S$ , we associate an inherited attribute  $S.next$  denoting a label for the instruction immediately after the code for  $S$ . In some cases, the instruction immediately following  $S.code$  is a jump to some label  $L$ . A jump to a jump to  $L$  from within  $S.code$  is avoided using  $S.next$ .

The syntax-directed definition in Fig. 6.36-6.37 produces three-address code for boolean expressions in the context of if, if-else-, and while-statements.

PRODUCTION	SEMANTIC RULES
$P \rightarrow S$	$S.next = newlabelQ$ $P.code = S.code \parallel label(S.next)$
$S \rightarrow \text{assign}$	$S.code = \text{assign}, code$
$S \rightarrow \text{if}(B)S_1$	$B.true = newlabelQ$ $B.false = S_1.next = S.next$ $S.code = B.code \parallel labelQB.true) \parallel S_1.code$
$S \rightarrow \text{if} ( B ) S_1 \text{ else } S_2$	$B.true = newlabelQ$ $B.false = newlabelQ$ $S_1.next = S_2.next = S.next$ $S.code = B.code$ $\parallel label(B.true) \parallel S_1.code$ $\parallel gen('goto' S.next)$ $\parallel label(B.false) \parallel S_2.code$
$S \rightarrow \text{while} ( B ) S_1$	$begin = newlabelQ$ $B.true = newlabelQ$ $B.false = S.next$ $S_1.next = begin$ $S.code = label(begin) \parallel B.code$ $\parallel label(B.true) \parallel S_1.code$ $\parallel gen('goto' \&\#m)$
$S \rightarrow S_1 S_2$	$S_1.next = newlabelQ$ $S_2.next = S.next$ $S.code = S_1.code \parallel label(S_1.next) \parallel S_2.code$

Figure 6.36: Syntax-directed definition for flow-of-control statements.

We assume that  $newlabelQ$  creates a new label each time it is called, and that  $label(L)$  attaches label  $L$  to the next three-address instruction to be generated.<sup>8</sup>

<sup>8</sup>If implemented literally, the semantic rules will generate lots of labels and may attach more than one label to a three-address instruction. The backpatching approach of Section 6.7

A program consists of a statement generated by  $P \rightarrow S$ . The semantic rules associated with this production initialize  $S.next$  to a new label.  $P.code$  consists of  $S.code$  followed by the new label  $S.next$ . Token **assign** in the production  $S \rightarrow \mathbf{assign}$  is a placeholder for assignment statements. The translation of assignments is as discussed in Section 6.4; for this discussion of control flow,  $S.code$  is simply **assign.code**.

In translating  $S \rightarrow \mathbf{if} (B) S_i$ , the semantic rules in Fig. 6.36 create a new label  $B.true$  and attach it to the first three-address instruction generated for the statement  $S_i$ , as illustrated in Fig. 6.35(a). Thus, jumps to  $B.true$  within the code for  $B$  will go to the code for  $S_i$ . Further, by setting  $B.false$  to  $S.next$ , we ensure that control will skip the code for  $S_i$  if  $B$  evaluates to false.

In translating the if-else-statement  $S \rightarrow \mathbf{if} (B) S_1 \mathbf{else} S_2$ , the code for the boolean expression  $B$  has jumps out of it to the first instruction of the code for  $S_1$  if  $B$  is true, and to the first instruction of the code for  $S_2$  if  $B$  is false, as illustrated in Fig. 6.35(b). Further, control flows from both  $S_1$  and  $S_2$  to the three-address instruction immediately following the code for  $S$  — its label is given by the inherited attribute  $S.next$ . An explicit **goto**  $S.next$  appears after the code for  $S_1$  to skip over the code for  $S_2$ . No goto is needed after  $S_2$ , since  $S_2.next$  is the same as  $S.next$ .

The code for  $S \rightarrow \mathbf{while} (B) S_i$  is formed from  $B.code$  and  $S_i.code$  as shown in Fig. 6.35(c). We use a local variable *begin* to hold a new label attached to the first instruction for this while-statement, which is also the first instruction for  $B$ . We use a variable rather than an attribute, because *begin* is local to the semantic rules for this production. The inherited label  $S.next$  marks the instruction that control must flow to if  $B$  is false; hence,  $B.false$  is set to be  $S.next$ . A new label  $B.true$  is attached to the first instruction for  $S_i$ ; the code for  $B$  generates a jump to this label if  $B$  is true. After the code for  $S_i$  we place the instruction **goto** *begin*, which causes a jump back to the beginning of the code for the boolean expression. Note that  $S_i.next$  is set to this label *begin*, so jumps from within  $S_i.code$  can go directly to *begin*.

The code for  $S \rightarrow S_1 S_2$  consists of the code for  $S_1$  followed by the code for  $S_2$ . The semantic rules manage the labels; the first instruction after the code for  $S_1$  is the beginning of the code for  $S_2$ ; and the instruction after the code for  $S_2$  is also the instruction after the code for  $S$ .

We discuss the translation of flow-of-control statements further in Section 6.7. There we shall see an alternative method, called "backpatching," which emits code for statements in one pass.

#### 6.6.4 Control-Flow Translation of Boolean Expressions

The semantic rules for boolean expressions in Fig. 6.37 complement the semantic rules for statements in Fig. 6.36. As in the code layout of Fig. 6.35, a boolean expression  $B$  is translated into three-address instructions that evaluate  $B$  using

creates labels only when they are needed. Alternatively, unnecessary labels can be eliminated during a subsequent optimization phase.

conditional and unconditional jumps to one of two labels:  $B.true$  if  $B$  is true, and  $B.false$  if  $B$  is false.

PRODUCTION	SEMANTIC RULES
$B \rightarrow B_1 \parallel B_2$	$B_1.true = B.true$ $B_1.false = newlabelQ$ $B_2.true = B.true$ $B_2.false = B.false$ $B.code = B_1.code \parallel label(B_1.false) \parallel B_2.code$
$B \rightarrow B_1 B_2$	$B_1.true = newlabelQ$ $B_1.false = B.false$ $B_2.true = B.true$ $B_2.false = B.false$ $B.code = B_1.code \parallel label(B_1.true) \parallel B_2.code$
$B \rightarrow !B_1$	$B_1.true = B.false$ $B_1.false = B.true$ $B.code = B_1.code$
$B \rightarrow E_1 \text{ rel } E_2$	$B.code = E_1.code \parallel E_2.code$ $\parallel genQif\ E_1.addr\ rel.op\ E_2.addr\ 'goto'\ B.true)$ $\parallel <en('goto'\ B.false)$
$B \rightarrow true$	$B.code = gen('goto'\ B.true)$
$B \rightarrow false$	$B.code = gen('goto'\ B.false)$

Figure 6.37: Generating three-address code for booleans

The fourth production in Fig. 6.37,  $B \rightarrow E_1 \text{ rel } E_2$ , is translated directly into a comparison three-address instruction with jumps to the appropriate places. For instance,  $B$  of the form  $a < b$  translates into:

```
if a < b goto B.true
goto B.false
```

The remaining productions for  $B$  are translated as follows:

1. Suppose  $B$  is of the form  $B_1 \parallel B_2$ . If  $B_1$  is true, then we immediately know that  $B$  itself is true, so  $B_1.true$  is the same as  $B.true$ . If  $B_1$  is false, then  $B_2$  must be evaluated, so we make  $B_1.false$  be the label of the first instruction in the code for  $B_2$ . The true and false exits of  $B_1$  are the same as the true and false exits of  $B$ , respectively.

2. The translation of  $B$ ,  $kk B_2$  is similar.
3. No code is needed for an expression  $B$  of the form  $\setminus Bi$ . just interchange the true and false exits of  $B$  to get the true and false exits of  $B\pm$
4. The constants true and false translate into jumps to  $B.true$  and  $B.false$ , respectively.

Example 6.22 : Consider again the following statement from Example 6.21:

$$\text{if} ( x < 100 \ \mathbf{I} \ \mathbf{I} \ x > 200 \ \&\& \ x \neq y ) \ x = 0; \quad (6.13)$$

Using the syntax-directed definitions in Figs. 6.36 and 6.37 we would obtain the code in Fig. 6.38.

```

        if x < 100 goto L2
        goto L3
L3:   if x > 200 goto L4
        goto Li
L4:   if x != y goto L3
        goto Li
L2:   x = 0
Li:

```

Figure 6.38: Control-flow translation of a simple if-statement

The statement (6.13) constitutes a program generated by  $P \rightarrow S$  from Fig. 6.36. The semantic rules for the production generate a new label  $L\setminus$  for the instruction after the code for  $S$ . Statement  $S$  has the form  $\text{if}(B) \ \mathbf{Si}$ , where  $\mathbf{Si}$  is  $x = 0$ ;, so the rules in Fig. 6.36 generate a new label  $L_2$  and attach it to the first (and only, in this case) instruction in  $Si.code$ , which is  $x = 0$ .

Since  $\mathbf{I} \ \mathbf{I}$  has lower precedence than  $kk$ , the boolean expression in (6.13) has the form  $Bi \setminus \setminus B_2$ , where  $Bi$  is  $x < 100$ . Following the rules in Fig. 6.37,  $Bi.true$  is  $L_2$ , the label of the assignment  $x = 0$ ;.  $Bi.false$  is a new label  $L_3$ , attached to the first instruction in the code for  $B_2$ .

Note that the code generated is not optimal, in that the translation has three more instructions (goto's) than the code in Example 6.21. The instruction  $\text{goto } L_3$  is redundant, since  $L_3$  is the label of the very next instruction. The two  $\text{goto } Li$  instructions can be eliminated by using  $\text{ifFalse}$  instead of  $\text{if}$  instructions, as in Example 6.21. •

### 6.6.5 Avoiding Redundant Gotos

In Example 6.22, the comparison  $x > 200$  translates into the code fragment:

```

        if x > 200 goto Li
        goto Li
Li:   ...

```

Instead, consider the instruction:

```

        ifFalse x > 200 goto Li
Li:   ...

```

This `ifFalse` instruction takes advantage of the natural flow from one instruction to the next in sequence, so control simply "falls through" to label  $L_i$  if  $x > 200$  is false, thereby avoiding a jump.

In the code layouts for `if`- and `while`-statements in Fig. 6.35, the code for statement  $S_{\pm}$  immediately follows the code for the boolean expression  $B$ . By using a special label *fall* (i.e., "don't generate any jump"), we can adapt the semantic rules in Fig. 6.36 and 6.37 to allow control to fall through from the code for  $B$  to the code for  $S_i$ . The new rules for  $S \rightarrow \text{if}(B) S_i$  in Fig. 6.36 set  $B.true$  to *fall*:

$$\begin{aligned}
 B.true &= fall \\
 B.false &= S_i.next = S.next \\
 S.code &= B.code \parallel S_i.code
 \end{aligned}$$

Similarly, the rules for `if-else`- and `while`-statements also set  $B.true$  to *fall*.

We now adapt the semantic rules for boolean expressions to allow control to fall through whenever possible. The new rules for  $B \rightarrow E_1 \text{ rel } E_2$  in Fig. 6.39 generate two instructions, as in Fig. 6.37, if both  $B.true$  and  $B.false$  are explicit labels; that is, neither equals *fall*. Otherwise, if  $B.true$  is an explicit label, then  $B.false$  must be *fall*, so they generate an `if` instruction that lets control fall through if the condition is false. Conversely, if  $B.false$  is an explicit label, then they generate an `ifFalse` instruction. In the remaining case, both  $B.true$  and  $B.false$  are *fall*, so no jump is generated.<sup>7</sup>

In the new rules for  $B \rightarrow B_1 \parallel B_2$  in Fig. 6.40, note that the meaning of label *fall* for  $B$  is different from its meaning for  $B_i$ . Suppose  $B.true$  is *fall*; i.e., control falls through  $B$ , if  $B$  evaluates to true. Although  $B$  evaluates to true if  $B_i$  does,  $B_i.true$  must ensure that control jumps over the code for  $B_2$  to get to the next instruction after  $B$ .

On the other hand, if  $B_i$  evaluates to false, the truth-value of  $B$  is determined by the value of  $B_2$ , so the rules in Fig. 6.40 ensure that  $B_i.false$  corresponds to control falling through from  $B_i$  to the code for  $B_2$ .

The semantic rules for  $B \rightarrow B_1 \text{ kk } B_2$  are similar to those in Fig. 6.40. We leave them as an exercise.

**Example 6.23:** With the new rules using the special label *fall*, the program (6.13) from Example 6.21

<sup>7</sup>In C and Java, expressions may contain assignments within them, so code must be generated for the subexpressions  $E_1$  and  $E_2$ , even if both  $B.true$  and  $B.false$  are *fall*. If desired, dead code can be eliminated during an optimization phase.

```

test = Ei.addr rel.op E2.addr
s = if B.true ^ fall and B.false ^ fall then
    gen('≠' test 'goto' B.true) || #en('goto' B.false)
    else if B.true ^ fall then gen('≠' test 'goto' B.true)
    else if B.false ^ fall then gen('ifFalse' test 'goto' B.false)
    else ''
B.code = Ei.code || E2.code || s

```

Figure 6.39: Semantic rules for  $B \wedge E_i \text{ rel } \neq?$ .

```

Bi.true = if B.true ^ fall then B.true else newlabelQ
B i. false = fall
B2.true = B.true
B2.false = B.false
B.code = if B.true ^ fall then Bi.code || B2.code
         else Bi.code || B2.code || label(Bi.true)

```

Figure 6.40: Semantic rules for  $B \rightarrow S_i \text{ I I } \_B$ .

```
if( x < 100 || x > 200 && x != y ) x = 0;
```

translates into the code of Fig. 6.41.

```

    if x < 100 goto L2
    ifFalse x > 200 goto L2
    ifFalse x != y goto Li
L2:  x = 0
Li:

```

Figure 6.41: If-statement translated using the fall-through technique

As in Example 6.22, the rules for  $P \rightarrow S$  create label  $Li$ . The difference from Example 6.22 is that the inherited attribute  $B.true$  is *fall* when the semantic rules for  $B \rightarrow B_i \text{ I I } B_2$  are applied ( $B.false$  is  $Li$ ). The rules in Fig. 6.40 create a new label  $L_2$  to allow a jump over the code for  $B_2$  if  $B_i$  evaluates to true. Thus,  $B_i.true$  is  $L_2$  and  $B_i.false$  is  $/a//$ , since  $\neq?$  must be evaluated if  $B_i$  is false.

The production  $B \rightarrow E_1 \text{ rel } E_2$  that generates  $x < 100$  is therefore reached with  $B.true = L_2$  and  $B.false = /a//$ . With these inherited labels, the rules in Fig. 6.39 therefore generate a single instruction `if x < 100 goto L2.`

### 6.6.6 Boolean Values and Jumping Code

The focus in this section has been on the use of boolean expressions to alter the flow of control in statements. A boolean expression may also be evaluated for its value, as in assignment statements such as `x = true;` or `x = a < b;`.

A clean way of handling both roles of boolean expressions is to first build a syntax tree for expressions, using either of the following approaches:

1. *Use two passes.* Construct a complete syntax tree for the input, and then walk the tree in depth-first order, computing the translations specified by the semantic rules.
2. *Use one pass for statements, but two passes for expressions.* With this approach, we would translate  $E$  in **while** ( $E$ )  $S_i$  before  $S_i$  is examined. The translation of  $E$ , however, would be done by building its syntax tree and then walking the tree.

The following grammar has a single nonterminal  $E$  for expressions:

$$\begin{aligned}
 S \rightarrow id &= E ; \mid i f ( E ) S \mid \text{while } ( E ) S \mid S S \\
 E &\rightarrow E \mid E \&\& E \mid E \vee E \mid E + E \mid \{ E \} id \mid \text{true} \mid \text{false}
 \end{aligned}$$

Nonterminal  $E$  governs the flow of control in  $S \rightarrow \text{while } ( E ) S_i$ . The same nonterminal  $E$  denotes a value in  $S \rightarrow id = E$ ; and  $E \rightarrow E + E$ .

We can handle these two roles of expressions by using separate code-generation functions. Suppose that attribute  $E.n$  denotes the syntax-tree node for an expression  $E$  and that nodes are objects. Let method *jump* generate jumping code at an expression node, and let method *rvalue* generate code to compute the value of the node into a temporary.

When  $E$  appears in  $S \rightarrow \text{while } ( E ) S_i$ , method *jump* is called at node  $E.n$ . The implementation of *jump* is based on the rules for boolean expressions in Fig. 6.37. Specifically, jumping code is generated by calling  $E.n.jump(t, /)$ , where  $t$  is a new label for the first instruction of  $S_i.code$  and  $/$  is the label  $S.next$ .

When  $E$  appears in  $S \rightarrow id = E$ , method *rvalue* is called at node  $E.n$ . If  $E$  has the form  $E_1 + E_2$ , the method call  $E.n.rvalueQ$  generates code as discussed in Section 6.4. If  $E$  has the form  $E_1 \&\& E_2$ , we first generate jumping code for  $E_1$  and then assign true or false to a new temporary  $t$  at the true and false exits, respectively, from the jumping code.

For example, the assignment `x = a < b && c < d` can be implemented by the code in Fig. 6.42.

### 6.6.7 Exercises for Section 6.6

**Exercise 6.6.1:** Add rules to the syntax-directed definition of Fig. 6.36 for the following control-flow constructs:

- a) A repeat-statement **repeat**  $S$  **while**  $B$ .

```

        ifFalse a < b goto Li
        ifFalse c > d goto Li
        t = true
        goto L2
Li:    t = false
L2:  x = t

```

Figure 6.42: Translating a boolean assignment by computing the value of a temporary

! b) A for-loop **for** ( $S_i$ ;  $B$ ;  $S_j$ )  $S_r$ .

**Exercise 6.6.2:** Modern machines try to execute many instructions at the same time, including branching instructions. Thus, there is a severe cost if the machine speculatively follows one branch, when control actually goes another way (all the speculative work is thrown away). It is therefore desirable to minimize the number of branches. Notice that the implementation of a while-loop in Fig. 6.35(c) has two branches per iteration: one to enter the body from the condition  $B$  and the other to jump back to the code for  $B$ . As a result, it is usually preferable to implement **while** ( $B$ )  $S$  as if it were **if** ( $B$ ) { **repeat**  $S$  **until**  $\neg(B)$  }. Show what the code layout looks like for this translation, and revise the rule for while-loops in Fig. 6.36.

! **Exercise 6.6.3:** Suppose that there were an "exclusive-or" operator (true if and only if exactly one of its two arguments is true) in C. Write the rule for this operator in the style of Fig. 6.37.

**Exercise 6.6.4:** Translate the following expressions using the goto-avoiding translation scheme of Section 6.6.5:

a) if (a==b *kk* c==d |I e==f) x == 1;

b) if (a==b |I c==d || e==f) x == 1;

c) if (a==b && c==d *kk* e==f) x == 1;

**Exercise 6.6.5:** Give a translation scheme based on the syntax-directed definition in Figs. 6.36 and 6.37.

**Exercise 6.6.6:** Adapt the semantic rules in Figs. 6.36 and 6.37 to allow control to fall through, using rules like the ones in Figs. 6.39 and 6.40.

! **Exercise 6.6.7:** The semantic rules for statements in Exercise 6.6.6 generate unnecessary labels. Modify the rules for statements in Fig. 6.36 to create labels as needed, using a special label *deferred* to mean that a label has not yet been created. Your rules must generate code similar to that in Example 6.21.



- \ Exercise 6.6.8: Section 6.6.5 talks about using fall-through code to minimize the number of jumps in the generated intermediate code. However, it does not take advantage of the option to replace a condition by its complement, e.g., replace `if a < b goto Li; goto L;` by `if b >= a goto L; goto L`. Develop a SDD that does take advantage of this option when needed.

## 6.7 Backpatching

A key problem when generating code for boolean expressions and flow-of-control statements is that of matching a jump instruction with the target of the jump. For example, the translation of the boolean expression  $B$  in `if (B) S` contains a jump, for when  $B$  is false, to the instruction following the code for  $S$ . In a one-pass translation,  $B$  must be translated before  $S$  is examined. What then is the target of the `goto` that jumps over the code for  $S$ ? In Section 6.6 we addressed this problem by passing labels as inherited attributes to where the relevant jump instructions were generated. But a separate pass is then needed to bind labels to addresses.

This section takes a complementary approach, called *backpatching*, in which lists of jumps are passed as synthesized attributes. Specifically, when a jump is generated, the target of the jump is temporarily left unspecified. Each such jump is put on a list of jumps whose labels are to be filled in when the proper label can be determined. All of the jumps on a list have the same target label.

### 6.7.1 One-Pass Code Generation Using Backpatching

Backpatching can be used to generate code for boolean expressions and flow-of-control statements in one pass. The translations we generate will be of the same form as those in Section 6.6, except for how we manage labels.

In this section, synthesized attributes *truelist* and *falselist* of nonterminal  $B$  are used to manage labels in jumping code for boolean expressions. In particular,  $B.truelist$  will be a list of jump or conditional jump instructions into which we must insert the label to which control goes if  $B$  is true.  $B.falselist$  likewise is the list of instructions that eventually get the label to which control goes when  $B$  is false. As code is generated for  $B$ , jumps to the true and false exits are left incomplete, with the label field unfilled. These incomplete jumps are placed on lists pointed to by  $B.truelist$  and  $B.falselist$ , as appropriate. Similarly, a statement  $S$  has a synthesized attribute  $S.nextlist$ , denoting a list of jumps to the instruction immediately following the code for  $S$ .

For specificity, we generate instructions into an instruction array, and labels will be indices into this array. To manipulate lists of jumps, we use three functions:

1. *makelist(i)* creates a new list containing only  $i$ , an index into the array of instructions; *makelist* returns a pointer to the newly created list.

2.  $merge(p_i, p_s)$  concatenates the lists pointed to by  $p_i$  and  $p_s$ , and returns a pointer to the concatenated list.
3.  $backpatch(p, i)$  inserts  $i$  as the target label for each of the instructions on the list pointed to by  $p$ .

## 6.7.2 Backpatching for Boolean Expressions

We now construct a translation scheme suitable for generating code for boolean expressions during bottom-up parsing. A marker nonterminal  $M$  in the grammar causes a semantic action to pick up, at appropriate times, the index of the next instruction to be generated. The grammar is as follows:

$$\begin{aligned}
 B &\rightarrow B_1 \mid I \mid M B_2 \mid B_1 \text{ kk } M B_2 \mid ! B_1 \mid ( B_1 ) \mid E_1 \text{ rel } E_2 \mid \text{true} \mid \text{false} \\
 M &\rightarrow \bullet e
 \end{aligned}$$

The translation scheme is in Fig. 6.43.

$$\begin{aligned}
 B &\rightarrow \bullet B_1 \mid I \mid M B_2 && \{ \text{backpatch}(B_1.\text{falselist}, M.\text{instr}); \\
 & && B.\text{truelist} = \text{merge}(B_1.\text{truelist}, B_2.\text{truelist}); \\
 & && B.\text{falselist} = B_2.\text{falselist}; \} \\
 B &\rightarrow B_1 \text{ kk } M B_2 && \{ \text{backpatch}(B_1.\text{truelist}, M.\text{instr}); \\
 & && B.\text{truelist} = B_1.\text{truelist}; \\
 & && B.\text{falselist} = \text{merge}(B_1.\text{falselist}, B_2.\text{falselist}); \} \\
 B &\rightarrow \bullet ! B_1 && \{ B.\text{truelist} = B_1.\text{falselist}; \\
 & && B.\text{falselist} = B_1.\text{truelist}; \} \\
 4) \quad B &\rightarrow ( B_1 ) && \{ B.\text{truelist} = B_1.\text{truelist}; \\
 & && B.\text{falselist} = B_1.\text{falselist}; \} \\
 5) \quad B &\rightarrow E_1 \text{ rel } E_2 && \{ B.\text{truelist} = \text{makelist}(\text{nextinstr}); \\
 & && B.\text{falselist} = \text{makelist}(\text{nextinstr} + 1); \\
 & && \text{emit}(\text{'\#f' } E_1.\text{addr rel.op } E_2.\text{addr 'goto \_'}); \\
 & && \text{emit}(\text{'goto \_'}); \} \\
 B &\rightarrow \text{true} && \{ B.\text{truelist} = \text{makelist}(\text{nextinstr}); \\
 & && \text{emit}(\text{'goto \_'}); \} \\
 B &\rightarrow \text{false} && \{ B.\text{falselist} = \text{makelist}(\text{nextinstr}); \\
 & && \text{emit}(\text{'goto \_'}); \} \\
 M &\rightarrow \bullet e && \{ M.\text{instr} = \text{nextinstr}; \}
 \end{aligned}$$

Figure 6.43: Translation scheme for boolean expressions

Consider semantic action (1) for the production  $B \rightarrow B_1 \mid I \mid M B_2$ . If  $B_1$  is true, then  $B$  is also true, so the jumps on  $B_1.\text{truelist}$  become part of  $B.\text{truelist}$ . If  $B_1$  is false, however, we must next test  $B_2$ , so the target for the jumps

$B \rightarrow i.falselist$  must be the beginning of the code generated for  $B$ . This target is obtained using the marker nonterminal  $M$ . That nonterminal produces, as a synthesized attribute  $M.instr$ , the index of the next instruction, just before  $B$  code starts being generated.

To obtain that instruction index, we associate with the production  $M \rightarrow \epsilon$  the semantic action

$$\{ M.instr = nextinstr, \}$$

The variable  $nextinstr$  holds the index of the next instruction to follow. This value will be backpatched onto the  $B_i.falselist$  (i.e., each instruction on the list  $B_i.falselist$  will receive  $M.instr$  as its target label) when we have seen the remainder of the production  $B \rightarrow \bullet B_i \text{ I I } M B_r$ .

Semantic action (2) for  $B \rightarrow B_l \text{ kk } M B_r$  is similar to (1). Action (3) for  $B \rightarrow \bullet IB$  swaps the true and false lists. Action (4) ignores parentheses.

For simplicity, semantic action (5) generates two instructions, a conditional goto and an unconditional one. Neither has its target filled in. These instructions are put on new lists, pointed to by  $B.truelist$  and  $B.falselist$ , respectively.

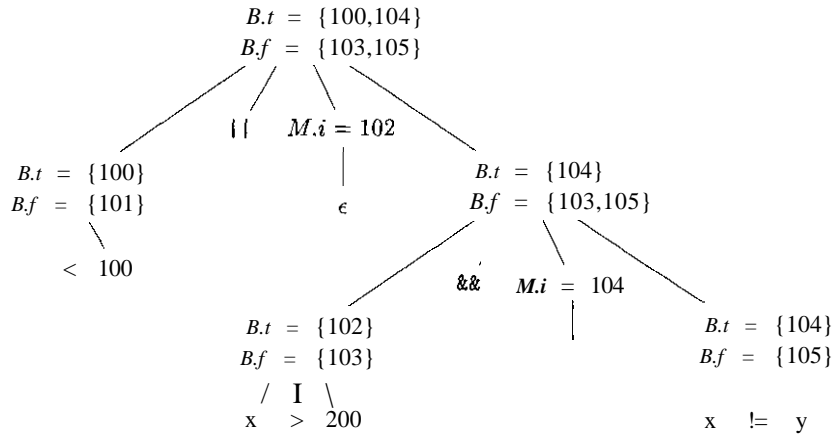

Figure 6.44: Annotated parse tree for  $x < 100 \text{ I I } x > 200 \text{ kk } x \neq y$

**Example 6.24:** Consider again the expression

$$x < 100 \text{ I I } x > 200 \text{ kk } x \neq y$$

An annotated parse tree is shown in Fig. 6.44; for readability, attributes  $truelist$ ,  $falselist$ , and  $instr$  are represented by their initial letters. The actions are performed during a depth-first traversal of the tree. Since all actions appear at the ends of right sides, they can be performed in conjunction with reductions during a bottom-up parse. In response to the reduction of  $x < 100$  to  $B$  by production (5), the two instructions

```

100:  if x < 100 goto _
101:  goto _

```

are generated. (We arbitrarily start instruction numbers at 100.) The marker nonterminal  $M$  in the production

$$B^{\wedge}B_i \setminus MB_i$$

records the value of *nextinstr*, which at this time is 102. The reduction of  $x > 200$  to  $B$  by production (5) generates the instructions

```

102:  if x > 200 goto _
103:  goto _

```

The subexpression  $x > 200$  corresponds to  $B \setminus$  in the production

$$B \quad B_i \quad kk \quad M \quad B_i$$

The marker nonterminal  $M$  records the current value of *nextinstr*, which is now 104. Reducing  $x \neq y$  into  $B$  by production (5) generates

```

104:  if x != y goto _
105:  goto _

```

We now reduce by  $B \rightarrow B \setminus kk M B_i$ . The corresponding semantic action calls *backpatch*( $B_i.truelist, M.instr$ ) to bind the true exit of  $B \setminus$  to the first instruction of  $B_i$ . Since  $B_i.truelist$  is {102} and  $M.instr$  is 104, this call to *backpatch* fills in 104 in instruction 102. The six instructions generated so far are thus as shown in Fig. 6.45(a).

The semantic action associated with the final reduction by  $B \rightarrow B \setminus \setminus MB_i$  calls *backpatch*({101},102) which leaves the instructions as in Fig. 6.45(b).

The entire expression is true if and only if the gotos of instructions 100 or 104 are reached, and is false if and only if the gotos of instructions 103 or 105 are reached. These instructions will have their targets filled in later in the compilation, when it is seen what must be done depending on the truth or falsehood of the expression. •

### 6.7.3 Flow-of-Control Statements

We now use backpatching to translate flow-of-control statements in one pass. Consider statements generated by the following grammar:

$$\begin{aligned}
 S &\rightarrow \text{if}(S) S \mid \text{if}(B)S \text{ else } S \mid \text{while}(B) S \mid \{ L \} \setminus A ; \\
 L &\rightarrow LS \mid S
 \end{aligned}$$

Here  $S$  denotes a statement,  $L$  a statement list,  $A$  an assignment-statement, and  $B$  a boolean expression. Note that there must be other productions, such as

```

100 | if x < 100 goto _
101 | goto _
102 | if x > 200 goto 104
103 | goto _
104 | if x != y goto _
105 | goto

```

(a) After backpatching 104 into instruction 102.

```

100 | if x < 100 goto _
101 | goto 102
102 | if y > 200 goto 104
103 | goto _
104 | if x != y goto _
105 | goto _

```

(b) After backpatching 102 into instruction 101.

Figure 6.45: Steps in the backpatch process

those for assignment-statements. The productions given, however, are sufficient to illustrate the techniques used to translate flow-of-control statements.

The code layout for if-, if-else-, and while-statements is the same as in Section 6.6. We make the tacit assumption that the code sequence in the instruction array reflects the natural flow of control from one instruction to the next. If not, then explicit jumps must be inserted to implement the natural sequential flow of control.

The translation scheme in Fig. 6.46 maintains lists of jumps that are filled in when their targets are found. As in Fig. 6.43, boolean expressions generated by nonterminal  $B$  have two lists of jumps,  $B.truelist$  and  $B.falselist$ , corresponding to the true and false exits from the code for  $B$ , respectively. Statements generated by nonterminals  $S$  and  $L$  have a list of unfilled jumps, given by attribute  $nextlist$ , that must eventually be completed by backpatching.  $S.nextlist$  is a list of all conditional and unconditional jumps to the instruction following the code for statement  $S$  in execution order.  $L.nextlist$  is defined similarly.

Consider the semantic action (3) in Fig. 6.46. The code layout for production  $S \rightarrow \mathbf{while} (B) S$  is as in Fig. 6.35(c). The two occurrences of the marker nonterminal  $M$  in the production

$$S \rightarrow \mathbf{while} M ( B ) M, S_i$$

record the instruction numbers of the beginning of the code for  $B$  and the beginning of the code for  $S_i$ . The corresponding labels in Fig. 6.35(c) are *begin* and *B.true*, respectively.

```

1) S -> if (B) M Si { backpatch{B.truelist, M.instr};
                      S.nextlist = merge(B.falselist, S.nextlist); }

2) S -> if(B)M,S,N e\seM,S,
      { backpatch(B .truelist, M.instr);
        backpatch(B .falselist, M.instr);
        temp = merge(S.nextlist, N.nextlist);
        S.nextlist = merge(temp, S.nextlist); }

3) S -> while M,(B)M,S,
      { backpatch(S.nextlist, My.instr);
        backpatch(B .truelist, M.instr);
        S.nextlist = B .falselist;
        emit('goto' My.instr); }

4) S -> { L } { S.nextlist = L.nextlist; }

5) S -> A ; { S.nextlist = null; }

6) M -> e { M.instr = nextinstr; }

7) iV e { N.nextlist = makelist(nextinstr);
          emit('goto _'); }

8) L -> Ly M S { backpatch(Li.nextlist, M.instr);
                 L .nextlist = S .nextlist; }

9) L -> S { L .nextlist = S .nextlist; }

```

Figure 6.46: Translation of statements

Again, the only production for  $Af$  is  $M \rightarrow e$ . Action (6) in Fig. 6.46 sets attribute  $M.instr$  to the number of the next instruction. After the body  $Si$  of the while-statement is executed, control flows to the beginning. Therefore, when we reduce **while**  $M_i(B) M_j Si$  to  $S$ , we backpatch  $S.nextlist$  to make all targets on that list be  $My.instr$ . An explicit jump to the beginning of the code for  $B$  is appended after the code for  $Si$  because control may also "fall out the bottom."  $B.truelist$  is backpatched to go to the beginning of  $Si$  by making jumps on  $B.truelist$  go to  $M_j.instr$ .

A more compelling argument for using  $S.nextlist$  and  $L.nextlist$  comes when code is generated for the conditional statement **if**  $(B) Si$  **else**  $S_j$ . If control "falls out the bottom" of  $Si$ , as when  $Si$  is an assignment, we must include at the end of the code for  $Si$  a jump over the code for  $S_j$ . We use another marker nonterminal to generate this jump after  $Si$ . Let nonterminal  $N$  be this

marker with production  $N \rightarrow e$ .  $N$  has attribute  $N.nextlist$ , which will be a list consisting of the instruction number of the jump `goto _` that is generated by the semantic action (7) for  $N$ .

Semantic action (2) in Fig. 6.46 deals with if-else-statements with the syntax

$$\mathbf{S} \rightarrow \mathbf{if} ( B ) \mathbf{M}_1 \mathbf{S}_1 \mathbf{N} \mathbf{else} \mathbf{M}_2 \mathbf{S}_2$$

We backpatch the jumps when  $B$  is true to the instruction  $M_1.instr$ ; the latter is the beginning of the code for  $\mathbf{S}_1$ . Similarly, we backpatch jumps when  $B$  is false to go to the beginning of the code for  $\mathbf{S}_2$ . The list  $S.nextlist$  includes all jumps out of  $\mathbf{S}_1$  and  $\mathbf{S}_2$ , as well as the jump generated by  $N$ . (Variable *temp* is a temporary that is used only for merging lists.)

Semantic actions (8) and (9) handle sequences of statements. In

$$L \rightarrow LxMS$$

the instruction following the code for  $Lx$  in order of execution is the beginning of  $\mathbf{S}$ . Thus the  $L.nextlist$  list is backpatched to the beginning of the code for  $\mathbf{S}$ , which is given by  $M.instr$ . In  $L \rightarrow \mathbf{S}$ ,  $L.nextlist$  is the same as  $S.nextlist$ .

Note that no new instructions are generated anywhere in these semantic rules, except for rules (3) and (7). All other code is generated by the semantic actions associated with assignment-statements and expressions. The flow of control causes the proper backpatching so that the assignments and boolean expression evaluations will connect properly.

### 6.7.4 Break-, Continue-, and Goto-Statements

The most elementary programming language construct for changing the flow of control in a program is the `goto`-statement. In C, a statement like `goto L` sends control to the statement labeled  $L$  — there must be precisely one statement with label  $L$  in this scope. Goto-statements can be implemented by maintaining a list of unfilled jumps for each label and then backpatching the target when it is known.

Java does away with `goto`-statements. However, Java does permit disciplined jumps called `break`-statements, which send control out of an enclosing construct, and `continue`-statements, which trigger the next iteration of an enclosing loop. The following excerpt from a lexical analyzer illustrates simple `break`- and `continue`-statements:

```

1) for ( ; ; readchQ ) {
2)     if( peek == ' ' || peek == '\t' ) continue;
3)     else if( peek == '\n' ) line = line + 1;
4)     else break;
5) }

```

Control jumps from the `break`-statement on line 4 to the next statement after the enclosing `for` loop. Control jumps from the `continue`-statement on line 2 to code to evaluate `readchQ` and then to the `if`-statement on line 2.

If  $S$  is the enclosing construct, then a break-statement is a jump to the first instruction after the code for  $S$ . We can generate code for the break by (1) keeping track of the enclosing statement  $S$ , (2) generating an unfilled jump for the break-statement, and (3) putting this unfilled jump on  $S.nextlist$ , where  $nextlist$  is as discussed in Section 6.7.3.

In a two-pass front end that builds syntax trees,  $S.nextlist$  can be implemented as a field in the node for  $S$ . We can keep track of  $S$  by using the symbol table to map a special identifier `break` to the node for the enclosing statement  $S$ . This approach will also handle labeled break-statements in Java, since the symbol table can be used to map the label to the syntax-tree node for the enclosing construct.

Alternatively, instead of using the symbol table to access the node for  $S$ , we can put a pointer to  $S.nextlist$  in the symbol table. Now, when a break-statement is reached, we generate an unfilled jump, look up  $nextlist$  through the symbol table, and add the jump to the list, where it will be backpatched as discussed in Section 6.7.3.

Continue-statements can be handled in a manner analogous to the break-statement. The main difference between the two is that the target of the generated jump is different.

### 6.7.5 Exercises for Section 6.7

Exercise 6.7.1: Using the translation of Fig. 6.43, translate each of the following expressions. Show the true and false lists for each subexpression. You may assume the address of the first instruction generated is 100.

- a) `a==b kk (c==d |I e==f)`
- b) `(a==b I I c==d) || e==f`
- c) `(a==b && c==d) kk e==f`

Exercise 6.7.2: In Fig. 6.47(a) is the outline of a program, and Fig. 6.47(b) sketches the structure of the generated three-address code, using the backpatching translation of Fig. 6.46. Here,  $i_1$  through  $i_n$  are the labels of the generated instructions that begin each of the "Code" sections. When we implement this translation, we maintain, for each boolean expression  $E$ , two lists of places in the code for  $E$ , which we denote by  $E.true$  and  $E.false$ . The places on list  $E.true$  are those places where we eventually put the label of the statement to which control must flow whenever  $E$  is true;  $E.false$  similarly lists the places where we put the label that control flows to when  $E$  is found to be false. Also, we maintain for each statement  $S$ , a list of places where we must put the label to which control flows when  $S$  is finished. Give the value (one of  $h$  through  $i_n$ ) that eventually replaces each place on each of the following lists:

- (a)  $E_z.false$
- (b)  $S_{i_1}.next$
- (c)  $E_{i_1}.false$
- (d)  $S_{i_2}.next$
- (e)  $E_{i_2}.true$



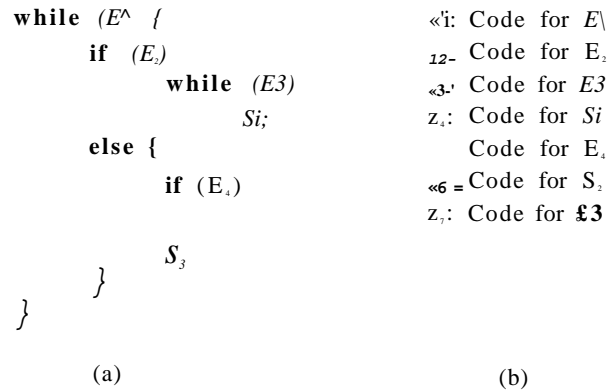

Figure 6.47: Control-flow structure of program for Exercise 6.7.2

**Exercise 6.7.3:** When performing the translation of Fig. 6.47 using the scheme of Fig. 6.46, we create lists  $S_i.next$  for each statement, starting with the assignment-statements  $S_1$ ,  $S_2$ , and  $S_3$ , and proceeding to progressively larger if-statements, if-else-statements, while-statements, and statement blocks. There are five constructed statements of this type in Fig. 6.47:

$S_1$ : **while** ( $E_1$ )  $S_1$ .

$S_2$ : **if** ( $S_4$ )  $S_2$ .

$S_5$ : The block consisting of  $S_5$  and  $S_3$ .

$S_7$ : The statement **if**  $S_1$  **else**  $S_5$ .

$S_8$ : The entire program.

For each of these constructed statements, there is a rule that allows us to construct  $S_i.next$  in terms of other  $S_j.next$  lists, and the lists  $E_i.true$  and  $E_i.false$  for the expressions in the program. Give the rules for

- (a)  $S_1.next$  (b)  $S_2.next$  (c)  $S_5.next$  (d)  $S_7.next$  (e)  $S_8.next$

## 6.8 Switch-Statements

The "switch" or "case" statement is available in a variety of languages. Our switch-statement syntax is shown in Fig. 6.48. There is a selector expression  $E$ , which is to be evaluated, followed by  $n$  constant values  $V_1, V_2, \dots, V_n$  that the expression might take, perhaps including a *default* "value," which always matches the expression if no other value does.

```

switch ( E ) {
    case V1: S1
    case V2: S2
    ...
    case Vn-1: Sn-1
    default: Sn
}

```

Figure 6.48: Switch-statement syntax

### 6.8.1 Translation of Switch-Statements

The intended translation of a switch is code to:

1. Evaluate the expression  $E$ .
2. Find the value  $V_j$  in the list of cases that is the same as the value of the expression. Recall that the default value matches the expression if none of the values explicitly mentioned in cases does.
3. Execute the statement  $S_j$  associated with the value found.

Step (2) is an  $n$ -way branch, which can be implemented in one of several ways. If the number of cases is small, say 10 at most, then it is reasonable to use a sequence of conditional jumps, each of which tests for an individual value and transfers to the code for the corresponding statement.

A compact way to implement this sequence of conditional jumps is to create a table of pairs, each pair consisting of a value and a label for the corresponding statement's code. The value of the expression itself, paired with the label for the default statement is placed at the end of the table at run time. A simple loop generated by the compiler compares the value of the expression with each value in the table, being assured that if no other match is found, the last (default) entry is sure to match.

If the number of values exceeds 10 or so, it is more efficient to construct a hash table for the values, with the labels of the various statements as entries. If no entry for the value possessed by the switch expression is found, a jump to the default statement is generated.

There is a common special case that can be implemented even more efficiently than by an  $n$ -way branch. If the values all lie in some small range, say  $min$  to  $max$ , and the number of different values is a reasonable fraction of  $max - min$ , then we can construct an array of  $max - min$  "buckets," where bucket  $j - min$  contains the label of the statement with value  $j$ ; any bucket that would otherwise remain unfilled contains the default label.

To perform the switch, evaluate the expression to obtain the value  $j$ ; check that it is in the range  $min$  to  $max$  and transfer indirectly to the table entry at offset  $j - min$ . For example, if the expression is of type character, a table of,

say, 128 entries (depending on the character set) may be created and transferred through with no range testing.

## 6.8.2 Syntax-Directed Translation of Switch-Statements

The intermediate code in Fig. 6.49 is a convenient translation of the switch-statement in Fig. 6.48. The tests all appear at the end so that a simple code generator can recognize the multiway branch and generate efficient code for it, using the most appropriate implementation suggested at the beginning of this section.

```

                                code to evaluate  $E$  into  $t$ 
                                goto test
Li:   code for  $S_i$ 
                                goto next
L2:  code for  $S_2$ 
                                goto next

Ln-1: code for  $S_{n-1}$ 
                                goto next
Ln:  code for  $S_n$ 
                                goto next
test:  if  $t = V_i$  goto Li
                                if  $t = V_2$  goto L2

                                if  $t = V_{n-1}$  goto Ln-1
                                goto Ln
next:

```

Figure 6.49: Translation of a switch-statement

The more straightforward sequence shown in Fig. 6.50 would require the compiler to do extensive analysis to find the most efficient implementation. Note that it is inconvenient in a one-pass compiler to place the branching statements at the beginning, because the compiler could not then emit code for each of the statements  $S_i$  as it saw them.

To translate into the form of Fig. 6.49, when we see the keyword **switch**, we generate two new labels **test** and **next**, and a new temporary  $t$ . Then, as we parse the expression  $E$ , we generate code to evaluate  $E$  into  $t$ . After processing  $E$ , we generate the jump **goto test**.

Then, as we see each **case** keyword, we create a new label  $L_i$  and enter it into the symbol table. We place in a queue, used only to store cases, a value-label pair consisting of the value  $V_i$  of the case constant and  $L_i$  (or a pointer to the symbol-table entry for  $L_i$ ). We process each statement **case**  $V_i$ :  $S_i$  by emitting the label  $L_i$  attached to the code for  $S_i$ , followed by the jump **goto next**.

```

                                code to evaluate  $E$  into  $t$ 
                                if  $t \neq V_1$  goto  $L_1$ 
                                code for  $S_1$ 
                                goto next
Li:                               if  $t \neq V_2$  goto  $L_2$ 
                                code for  $S_2$ 
                                goto next
L2:
Ln-1: if  $t \neq K_{-i}$  goto  $L_{n-i}$ 
                                code for  $S_{n-i}$ 
                                goto next
Ln-i: code for  $S_n$ 
next:

```

Figure 6.50: Another translation of a switch statement

When the end of the switch is found, we are ready to generate the code for the  $n$ -way branch. Reading the queue of value-label pairs, we can generate a sequence of three-address statements of the form shown in Fig. 6.51. There,  $t$  is the temporary holding the value of the selector expression  $E$ , and  $h_n$  is the label for the default statement.

```

case t V1 L1
case t V2 L2

case t Vn-i Ln-i
case t t Ln
label next

```

Figure 6.51: Case three-address-code instructions used to translate a switch-statement

The case  $t V_i h_i$  instruction is a synonym for  $\text{if } t = V_i \text{ goto } h_i$  in Fig. 6.49, but the case instruction is easier for the final code generator to detect as a candidate for special treatment. At the code-generation phase, these sequences of case statements can be translated into an  $n$ -way branch of the most efficient type, depending on how many there are and whether the values fall into a small range.

### 6.8.3 Exercises for Section 6.8

! Exercise 6.8.1: In order to translate a switch-statement into a sequence of case-statements as in Fig. 6.51, the translator needs to create the list of value-

label pairs, as it processes the source code for the switch. We can do so, using an additional translation that accumulates just the pairs. Sketch a syntax-direction definition that produces the list of pairs, while also emitting code for the statements  $S_i$  that are the actions for each case.

## 6.9 Intermediate Code for Procedures

Procedures and their implementation will be discussed at length in Chapter 7, along with the run-time management of storage for names. We use the term function in this section for a procedure that returns a value. We briefly discuss function declarations and three-address code for function calls. In three-address code, a function call is unraveled into the evaluation of parameters in preparation for a call, followed by the call itself. For simplicity, we assume that parameters are passed by value; parameter-passing methods are discussed in Section 1.6.6.

Example 6.25: Suppose that  $a$  is an array of integers, and that  $f$  is a function from integers to integers. Then, the assignment

$$n = f(a[i]);$$

might translate into the following three-address code:

- 1)  $t_1 = i * 4$
- 2)  $t_2 = a[t_1]$
- 3) param  $t_2$
- 4)  $t_3 = \text{call } f, 1$
- 5)  $n = t_3$

The first two lines compute the value of the expression  $a[i]$  into temporary  $t_2$ , as discussed in Section 6.4. Line 3 makes  $t_2$  an actual parameter for the call on line 4 of  $f$  with one parameter. Line 5 assigns the value returned by the function call to  $t_3$ . Line 6 assigns the returned value to  $n$ . •

The productions in Fig. 6.52 allow function definitions and function calls. (The syntax generates unwanted commas after the last parameter, but is good enough for illustrating translation.) Nonterminals  $D$  and  $T$  generate declarations and types, respectively, as in Section 6.3. A function definition generated by  $D$  consists of keyword `define`, a return type, the function name, formal parameters in parentheses and a function body consisting of a statement. Nonterminal  $F$  generates zero or more formal parameters, where a formal parameter consists of a type followed by an identifier. Nonterminals  $S$  and  $E$  generate statements and expressions, respectively. The production for  $S$  adds a statement that returns the value of an expression. The production for  $E$  adds function calls, with actual parameters generated by  $A$ . An actual parameter is an expression.

```

D  ->  define T id ( F ) { 5 }
F      e | T id , F
S  ->  return   ;
E  ->  id ( A )
A  ->  e ! E , A

```

Figure 6.52: Adding functions to the source language

Function definitions and function calls can be translated using concepts that have already been introduced in this chapter.

- *Function types.* The type of a function must encode the return type and the types of the formal parameters. Let *void* be a special type that represents no parameter or no return type. The type of a function *pop()* that returns an integer is therefore "function from *void* to *integer*." Function types can be represented by using a constructor *fun* applied to the return type and an ordered list of types for the parameters.
- *Symbol tables.* Let *s* be the top symbol table when the function definition is reached. The function name is entered into *s* for use in the rest of the program. The formal parameters of a function can be handled in analogy with field names in a record (see Fig. 6.18). In the production for D, after seeing **define** and the function name, we push *s* and set up a new symbol table

$$Env.push(top) \quad top = \mathbf{new} \quad Env(top);$$

Call the new symbol table, *t*. Note that *top* is passed as a parameter in **new** *Env(top)*, so the new symbol table *t* can be linked to the previous one, *s*. The new table *t* is used to translate the function body. We revert to the previous symbol table *s* after the function body is translated.

- *Type checking.* Within expressions, a function is treated like any other operator. The discussion of type checking in Section 6.5.2 therefore carries over, including the rules for coercions. For example, *if/is* is a function with a parameter of type *real*, then the integer 2 is coerced to a *real* in the call */(2)*.
- *Function calls.* When generating three-address instructions for a function call *id(E, E, ... , E)*, it is sufficient to generate the three-address instructions for evaluating or reducing the parameters *E* to addresses, followed by a *param* instruction for each parameter. If we do not want to mix the parameter-evaluating instructions with the *param* instructions, the attribute *E.addr* for each expression *E* can be saved in a data structure

such as a queue. Once all the expressions are translated, the param instructions can be generated as the queue is emptied.

The procedure is such an important and frequently used programming construct that it is imperative for a compiler to good code for procedure calls and returns. The run-time routines that handle procedure parameter passing, calls, and returns are part of the run-time support package. Mechanisms for run-time support are discussed in Chapter 7.

## 6.10 Summary of Chapter 6

The techniques in this chapter can be combined to build a simple compiler front end, like the one in Appendix A. The front end can be built incrementally:

- *Pick an intermediate representation:* An intermediate representation is typically some combination of a graphical notation and three-address code. As in syntax trees, a node in a graphical notation represents a construct; the children of a node represent its subconstructs. Three address code takes its name from instructions of the form  $x - y \text{ op } z$ , with at most one operator per instruction. There are additional instructions for control flow.
- 4- *Translate expressions:* Expressions with built-up operations can be unwound into a sequence of individual operations by attaching actions to each production of the form  $E \rightarrow E_1 \text{ op } E_2$ . The action either creates a node for  $E$  with the nodes for  $E_1$  and  $E_2$  as children, or it generates a three-address instruction that applies **op** to the addresses for  $E_1$  and  $E_2$  and puts the result into a new temporary name, which becomes the address for  $E$ .
- *Check types:* The type of an expression  $E_1 \text{ op } E_2$  is determined by the operator **op** and the types of  $E_1$  and  $E_2$ . A coercion is an implicit type conversion, such as from *integer* to *float*. Intermediate code contains explicit type conversions to ensure an exact match between operand types and the types expected by an operator.
- *Use a symbol table to implement declarations:* A declaration specifies the type of a name. The width of a type is the amount of storage needed for a name with that type. Using widths, the relative address of a name at run time can be computed as an offset from the start of a data area. The type and relative address of a name are put into the symbol table due to a declaration, so the translator can subsequently get them when the name appears in an expression.
- 4- *Flatten arrays:* For quick access, array elements are stored in consecutive locations. Arrays of arrays are flattened so they can be treated as a one-

dimensional array of individual elements. The type of an array is used to calculate the address of an array element relative to the base of the array.

*Generate jumping code for boolean expressions:* In short-circuit or jumping code, the value of a boolean expression is implicit in the position reached in the code. Jumping code is useful because a boolean expression  $B$  is typically used for control flow, as in `if (B) S`. Boolean values can be computed by jumping to `t = true` or `t = false`, as appropriate, where `t` is a temporary name. Using labels for jumps, a boolean expression can be translated by inheriting labels corresponding to its true and false exits. The constants *true* and *false* translate into a jump to the true and false exits, respectively.

- *Implement statements using control flow:* Statements can be translated by inheriting a label *next*, where *next* marks the first instruction after the code for this statement. The conditional `S -> if (B) Si` can be translated by attaching a new label marking the beginning of the code for `Si` and passing the new label and *S.next* for the true and false exits, respectively, *oiB*.
- *Alternatively, use backpatching:* Backpatching is a technique for generating code for boolean expressions and statements in one pass. The idea is to maintain lists of incomplete jumps, where all the jump instructions on a list have the same target. When the target becomes known, all the instructions on its list are completed by filling in the target.
- *Implement records:* Field names in a record or class can be treated as a sequence of declarations. A record type encodes the types and relative addresses of the fields. A symbol table object can be used for this purpose.

## 6.11 References for Chapter 6

Most of the techniques in this chapter stem from the flurry of design and implementation activity around Algol 60. Syntax-directed translation into intermediate code was well established by the time Pascal [11] and C [6, 9] were created.

UNCOL (for Universal Compiler Oriented Language) is a mythical universal intermediate language, sought since the mid 1950's. Given an UNCOL, compilers could be constructed by hooking a front end for a given source language with a back end for a given target language [10]. The bootstrapping techniques given in the report [10] are routinely used to retarget compilers.

The UNCOL ideal of mixing and matching front ends with back ends has been approached in a number of ways. A retargetable compiler consists of one front end that can be put together with several back ends to implement a given language on several machines. Neliac was an early example of a language with a retargetable compiler [5] written in its own language. Another approach is to



retrofit a front end for a new language onto an existing compiler. Feldman [2] describes the addition of a Fortran 77 front end to the C compilers [6] and [9]. GCC, the GNU Compiler Collection [3], supports front ends for C, C++, Objective-C, Fortran, Java, and Ada.

Value numbers and their implementation by hashing are from Ershov [1].

The use of type information to improve the security of Java bytecodes is described by Gosling [4].

Type inference by using unification to solve sets of equations has been rediscovered several times; its application to ML is described by Milner [7]. See Pierce [8] for a comprehensive treatment of types.

1. Ershov, A. P., "On programming of arithmetic operations," *Comm. ACM* **1:8** (1958), pp. 3-6. See also *Comm. ACM* **1:9** (1958), p. 16.
2. Feldman, S. I., "Implementation of a portable Fortran 77 compiler using modern tools," *ACM SIGPLAN Notices* **14:8** (1979), pp. 98-106
3. GCC home page <http://gcc.gnu.org/>, Free Software Foundation.
4. Gosling, J., "Java intermediate bytecodes," *Proc. ACM SIGPLAN Workshop on Intermediate Representations* (1995), pp. 111-118.
5. Huskey, H. D., M. H. Halstead, and R. McArthur, "Neliac — a dialect of Algol," *Comm. ACM* **3:8** (1960), pp. 463-468.
6. Johnson, S. C., "A tour through the portable C compiler," Bell Telephone Laboratories, Inc., Murray Hill, N. J., 1979.
7. Milner, R., "A theory of type polymorphism in programming," *J. Computer and System Sciences* **17:3** (1978), pp. 348-375.
8. Pierce, B.C., *Types and Programming Languages*, MIT Press, Cambridge, Mass., 2002.
9. Ritchie, D. M., "A tour through the UNIX C compiler," Bell Telephone Laboratories, Inc., Murray Hill, N. J., 1979.
10. Strong, J., J. Wegstein, A. Tritter, J. Olsztyn, O. Mock, and T. Steel, "The problem of programming communication with changing machines: a proposed solution," *Comm. ACM* **1:8** (1958), pp. 12-18. Part 2: **1:9** (1958), pp. 9-15. Report of the Share Ad-Hoc committee on Universal Languages.
11. Wirth, N. "The design of a Pascal compiler," *Software—Practice and Experience* **1:4** (1971), pp. 309-333.

## Chapter 7

# Run-Time Environments

A compiler must accurately implement the abstractions embodied in the source-language definition. These abstractions typically include the concepts we discussed in Section 1.6 such as names, scopes, bindings, data types, operators, procedures, parameters, and flow-of-control constructs. The compiler must cooperate with the operating system and other systems software to support these abstractions on the target machine.

To do so, the compiler creates and manages a *run-time environment* in which it assumes its target programs are being executed. This environment deals with a variety of issues such as the layout and allocation of storage locations for the objects named in the source program, the mechanisms used by the target program to access variables, the linkages between procedures, the mechanisms for passing parameters, and the interfaces to the operating system, input/output devices, and other programs.

The two themes in this chapter are the allocation of storage locations and access to variables and data. We shall discuss memory management in some detail, including stack allocation, heap management, and garbage collection. In the next chapter, we present techniques for generating target code for many common language constructs.

### 7.1 Storage Organization

From the perspective of the compiler writer, the executing target program runs in its own logical address space in which each program value has a location. The management and organization of this logical address space is shared between the compiler, operating system, and target machine. The operating system maps the logical addresses into physical addresses, which are usually spread throughout memory.

The run-time representation of an object program in the logical address space consists of data and program areas as shown in Fig. 7.1. A compiler for a

language like C++ on an operating system like Linux might subdivide memory in this way.

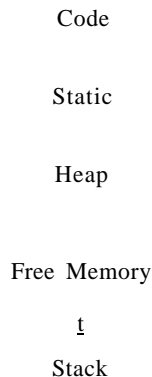

Figure 7.1: Typical subdivision of run-time memory into code and data areas

Throughout this book, we assume the run-time storage comes in blocks of contiguous bytes, where a byte is the smallest unit of addressable memory. A byte is eight bits and four bytes form a machine word. Multibyte objects are stored in consecutive bytes and given the address of the first byte.

As discussed in Chapter 6, the amount of storage needed for a name is determined from its type. An elementary data type, such as a character, integer, or float, can be stored in an integral number of bytes. Storage for an aggregate type, such as an array or structure, must be large enough to hold all its components.

The storage layout for data objects is strongly influenced by the addressing constraints of the target machine. On many machines, instructions to add integers may expect integers to be *aligned*, that is, placed at an address divisible by 4. Although an array of ten characters needs only enough bytes to hold ten characters, a compiler may allocate 12 bytes to get the proper alignment, leaving 2 bytes unused. Space left unused due to alignment considerations is referred to as *padding*. When space is at a premium, a compiler may *pack* data so that no padding is left; additional instructions may then need to be executed at run time to position packed data so that it can be operated on as if it were properly aligned.

The size of the generated target code is fixed at compile time, so the compiler can place the executable target code in a statically determined area *Code*, usually in the low end of memory. Similarly, the size of some program data objects, such as global constants, and data generated by the compiler, such as information to support garbage collection, may be known at compile time, and these data objects can be placed in another statically determined area called *Static*. One reason for statically allocating as many data objects as possible is

that the addresses of these objects can be compiled into the target code. In early versions of Fortran, all data objects could be allocated statically.

To maximize the utilization of space at run time, the other two areas, *Stack* and *Heap*, are at the opposite ends of the remainder of the address space. These areas are dynamic; their size can change as the program executes. These areas grow towards each other as needed. The stack is used to store data structures called activation records that get generated during procedure calls.

In practice, the stack grows towards lower addresses, the heap towards higher. However, throughout this chapter and the next we shall assume that the stack grows towards higher addresses so that we can use positive offsets for notational convenience in all our examples.

As we shall see in the next section, an activation record is used to store information about the status of the machine, such as the value of the program counter and machine registers, when a procedure call occurs. When control returns from the call, the activation of the calling procedure can be restarted after restoring the values of relevant registers and setting the program counter to the point immediately after the call. Data objects whose lifetimes are contained in that of an activation can be allocated on the stack along with other information associated with the activation.

Many programming languages allow the programmer to allocate and deallocate data under program control. For example, C has the functions `malloc` and `free` that can be used to obtain and give back arbitrary chunks of storage. The heap is used to manage this kind of long-lived data. Section 7.4 will discuss various memory-management algorithms that can be used to maintain the heap.

### 7.1.1 Static Versus Dynamic Storage Allocation

The layout and allocation of data to memory locations in the run-time environment are key issues in storage management. These issues are tricky because the same name in a program text can refer to multiple locations at run time. The two adjectives *static* and *dynamic* distinguish between compile time and run time, respectively. We say that a storage-allocation decision is static, if it can be made by the compiler looking only at the text of the program, not at what the program does when it executes. Conversely, a decision is *dynamic* if it can be decided only while the program is running. Many compilers use some combination of the following two strategies for dynamic storage allocation:

1. *Stack storage.* Names local to a procedure are allocated space on a stack. We discuss the "run-time stack" starting in Section 7.2. The stack supports the normal call/return policy for procedures.
2. *Heap storage.* Data that may outlive the call to the procedure that created it is usually allocated on a "heap" of reusable storage. We discuss heap management starting in Section 7.4. The heap is an area of virtual

memory that allows objects or other data elements to obtain storage when they are created and to return that storage when they are invalidated.

To support heap management, "garbage collection" enables the run-time system to detect useless data elements and reuse their storage, even if the programmer does not return their space explicitly. Automatic garbage collection is an essential feature of many modern languages, despite it being a difficult operation to do efficiently; it may not even be possible for some languages.

## 7.2 Stack Allocation of Space

Almost all compilers for languages that use procedures, functions, or methods as units of user-defined actions manage at least part of their run-time memory as a stack. Each time a procedure<sup>1</sup> is called, space for its local variables is pushed onto a stack, and when the procedure terminates, that space is popped off the stack. As we shall see, this arrangement not only allows space to be shared by procedure calls whose durations do not overlap in time, but it allows us to compile code for a procedure in such a way that the relative addresses of its nonlocal variables are always the same, regardless of the sequence of procedure calls.

### 7.2.1 Activation Trees

Stack allocation would not be feasible if procedure calls, or *activations* of procedures, did not nest in time. The following example illustrates nesting of procedure calls.

Example 7.1: Figure 7.2 contains a sketch of a program that reads nine integers into an array  $a$  and sorts them using the recursive quicksort algorithm.

The main function has three tasks. It calls *readArray*, sets the sentinels, and then calls *quicksort* on the entire data array. Figure 7.3 suggests a sequence of calls that might result from an execution of the program. In this execution, the call to *partition*(1,9) returns 4, so  $a[1]$  through  $a[3]$  hold elements less than its chosen separator value  $v$ , while the larger elements are in  $a[5]$  through  $a[9]$ . •

In this example, as is true in general, procedure activations are nested in time. If an activation of procedure  $p$  calls procedure  $q$ , then that activation of  $q$  must end before the activation of  $p$  can end. There are three common cases:

1. The activation of  $q$  terminates normally. Then in essentially any language, control resumes just after the point of  $p$  at which the call to  $q$  was made.
2. The activation of  $q$ , or some procedure  $q$  called, either directly or indirectly, aborts; i.e., it becomes impossible for execution to continue. In that case,  $p$  ends simultaneously with  $q$ .

<sup>1</sup>Recall we use "procedure" as a generic term for function, procedure, method, or subroutine.

```

int a[11];
void readArrayO { /* Reads 9 integers into o[1], ...,o[9]. */
    int i;

}
int partition(int m, int n) {
    /* Picks a separator value v, and partitions a[m..n] so that
       a[m..p-1] are less than v, a[p] = v, and a[p+1..n] are
       equal to or greater than v. Returns p. */

}
void quicksort(int m, int n) {
    int i;
    if (n > m) {
        i = partition(m, n);
        quicksort(m, i-1);
        quicksort(i+1, n);
    }
}
mainQ {
    readArrayO ;
    a[0] = -9999;
    a[10] = 9999;
    quicksort(1,9);
}

```

Figure 7.2: Sketch of a quicksort program

3. The activation of  $q$  terminates because of an exception that  $q$  cannot handle. Procedure  $p$  may handle the exception, in which case the activation of  $q$  has terminated while the activation of  $p$  continues, although not necessarily from the point at which the call to  $q$  was made. If  $p$  cannot handle the exception, then this activation of  $p$  terminates at the same time as the activation of  $q$ , and presumably the exception will be handled by some other open activation of a procedure.

We therefore can represent the activations of procedures during the running of an entire program by a tree, called an *activation tree*. Each node corresponds to one activation, and the root is the activation of the "main" procedure that initiates execution of the program. At a node for an activation of procedure  $p$ , the children correspond to activations of the procedures called by this activation of  $p$ . We show these activations in the order that they are called, from left to right. Notice that one child must finish before the activation to its right can begin.

## A Version of Quicksort

The sketch of a quicksort program in Fig. 7.2 uses two auxiliary functions *readArray* and *partition*. The function *readArray* is used only to load the data into the array *a*. The first and last elements of *a* are not used for data, but rather for "sentinels" set in the main function. We assume *a[0]* is set to a value lower than any possible data value, and *a[10]* is set to a value higher than any data value.

The function *partition* divides a portion of the array, delimited by the arguments *m* and *n*, so the low elements of *a[m]* through *a[n]* are at the beginning, and the high elements are at the end, although neither group is necessarily in sorted order. We shall not go into the way *partition* works, except that it may rely on the existence of the sentinels. One possible algorithm for *partition* is suggested by the more detailed code in Fig. 9.1.

Recursive procedure *quicksort* first decides if it needs to sort more than one element of the array. Note that one element is always "sorted," so *quicksort* has nothing to do in that case. If there are elements to sort, *quicksort* first calls *partition*, which returns an index *i* to separate the low and high elements. These two groups of elements are then sorted by two recursive calls to *quicksort*.

Example 7.2: One possible activation tree that completes the sequence of calls and returns suggested in Fig. 7.3 is shown in Fig. 7.4. Functions are represented by the first letters of their names. Remember that this tree is only one possibility, since the arguments of subsequent calls, and also the number of calls along any branch is influenced by the values returned by *partition*. •

The use of a run-time stack is enabled by several useful relationships between the activation tree and the behavior of the program:

1. The sequence of procedure calls corresponds to a preorder traversal of the activation tree.
2. The sequence of returns corresponds to a postorder traversal of the activation tree.
3. Suppose that control lies within a particular activation of some procedure, corresponding to a node *N* of the activation tree. Then the activations that are currently open (*live*) are those that correspond to node *N* and its ancestors. The order in which these activations were called is the order in which they appear along the path to *N*, starting at the root, and they will return in the reverse of that order.

```

enter mainQ
  enter readArrayO
  leave readArrayO
  enter quicksort(1,9)
    enter partition(1,9)
    leave partition(1,9)
    enter quicksort(1,3)

    leave quicksort(1,3)
    enter quicksort(5,9)

    leave quicksort(5,9)
  leave quicksort(1,9)
leave main()

```

Figure 7.3: Possible activations for the program of Fig. 7.2

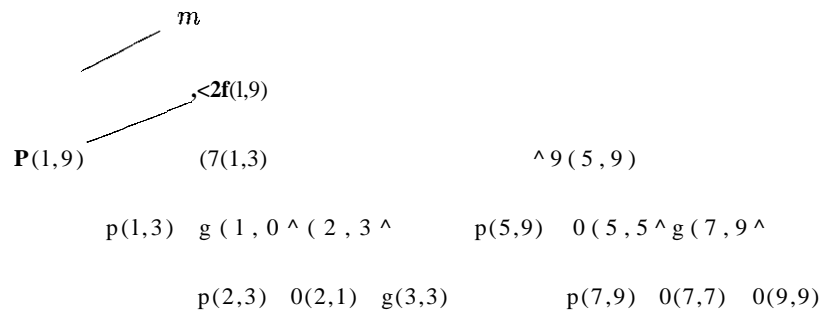
Figure 7.4: Activation tree representing calls during an execution of *quicksort*

### 7.2.2 Activation Records

Procedure calls and returns are usually managed by a run-time stack called the *control stack*. Each live activation has an *activation record* (sometimes called a *frame*) on the control stack, with the root of the activation tree at the bottom, and the entire sequence of activation records on the stack corresponding to the path in the activation tree to the activation where control currently resides. The latter activation has its record at the top of the stack.

**Example 7.3:** If control is currently in the activation  $0(2,3)$  of the tree of Fig. 7.4, then the activation record for  $q(2,3)$  is at the top of the control stack. Just below is the activation record for  $0(1,3)$ , the parent of  $0(2,3)$  in the tree. Below that is the activation record  $0(1,9)$ , and at the bottom is the activation record for  $m$ , the main function and root of the activation tree. •



We shall conventionally draw control stacks with the bottom of the stack higher than the top, so the elements in an activation record that appear lowest on the page are actually closest to the top of the stack.

The contents of activation records vary with the language being implemented. Here is a list of the kinds of data that might appear in an activation record (see Fig. 7.5 for a summary and possible order for these elements):

Actual parameters  
Returned values  
Control link  
Access link  
Saved machine status  
Local data  
Temporaries

Figure 7.5: A general activation record

1. Temporary values, such as those arising from the evaluation of expressions, in cases where those temporaries cannot be held in registers.
2. Local data belonging to the procedure whose activation record this is.
3. A saved machine status, with information about the state of the machine just before the call to the procedure. This information typically includes the *return address* (value of the program counter, to which the called procedure must return) and the contents of registers that were used by the calling procedure and that must be restored when the return occurs.
4. An "access link" may be needed to locate data needed by the called procedure but found elsewhere, e.g., in another activation record. Access links are discussed in Section 7.3.5.
5. A *control link*, pointing to the activation record of the caller.
6. Space for the return value of the called function, if any. Again, not all called procedures return a value, and if one does, we may prefer to place that value in a register for efficiency.
7. The actual parameters used by the calling procedure. Commonly, these values are not placed in the activation record but rather in registers, when possible, for greater efficiency. However, we show a space for them to be completely general.

**Example 7.4:** Figure 7.6 shows snapshots of the run-time stack as control flows through the activation tree of Fig. 7.4. Dashed lines in the partial trees go to activations that have ended. Since array  $a$  is global, space is allocated for it before execution begins with an activation of procedure  $main$ , as shown in Fig. 7.6(a).

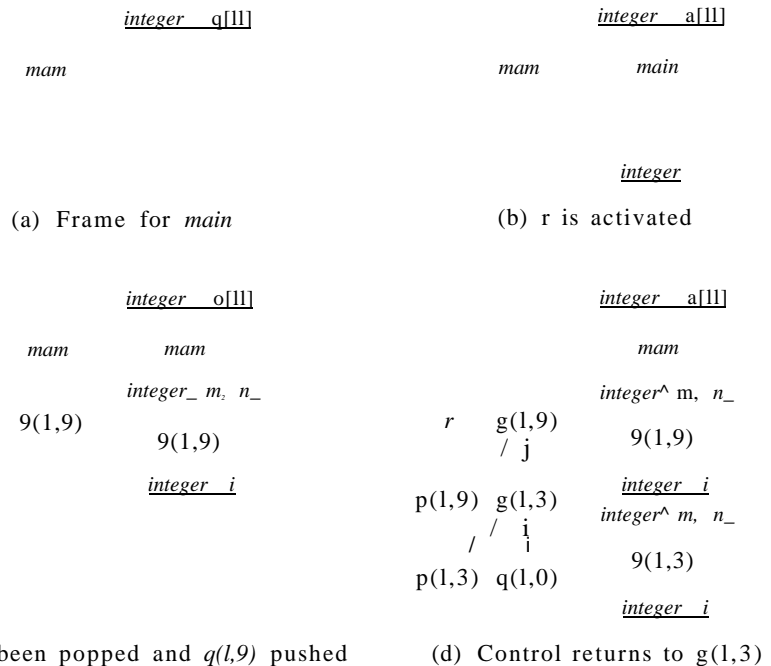

Figure 7.6: Downward-growing stack of activation records

When control reaches the first call in the body of  $main$ , procedure  $r$  is activated, and its activation record is pushed onto the stack (Fig. 7.6(b)). The activation record for  $r$  contains space for local variable  $i$ . Recall that the top of stack is at the bottom of diagrams. When control returns from this activation, its record is popped, leaving just the record for  $main$  on the stack.

Control then reaches the call to  $q$  (quicksort) with actual parameters 1 and 9, and an activation record for this call is placed on the top of the stack, as in Fig. 7.6(c). The activation record for  $q$  contains space for the parameters  $m$  and  $n$  and the local variable  $i$ , following the general layout in Fig. 7.5. Notice that space once used by the call of  $r$  is reused on the stack. No trace of data local to  $r$  will be available to  $q(l, 9)$ . When  $q(l, 9)$  returns, the stack again has only the activation record for  $main$ .

Several activations occur between the last two snapshots in Fig. 7.6. A recursive call to  $g(1,3)$  was made. Activations  $p(1,3)$  and  $q(1,0)$  have begun and ended during the lifetime of  $q(l, 3)$ , leaving the activation record for  $q(l, 3)$

on top (Fig. 7.6(d)). Notice that when a procedure is recursive, it is normal to have several of its activation records on the stack at the same time. •

### 7.2.3 Calling Sequences

Procedure calls are implemented by what are known as *calling sequences*, which consists of code that allocates an activation record on the stack and enters information into its fields. A *return sequence* is similar code to restore the state of the machine so the calling procedure can continue its execution after the call.

Calling sequences and the layout of activation records may differ greatly, even among implementations of the same language. The code in a calling sequence is often divided between the calling procedure (the "caller") and the procedure it calls (the "callee"). There is no exact division of run-time tasks between caller and callee; the source language, the target machine, and the operating system impose requirements that may favor one solution over another. In general, if a procedure is called from  $n$  different points, then the portion of the calling sequence assigned to the caller is generated  $n$  times. However, the portion assigned to the callee is generated only once. Hence, it is desirable to put as much of the calling sequence into the callee as possible — whatever the callee can be relied upon to know. We shall see, however, that the callee cannot know everything.

When designing calling sequences and the layout of activation records, the following principles are helpful:

1. Values communicated between caller and callee are generally placed at the beginning of the callee's activation record, so they are as close as possible to the caller's activation record. The motivation is that the caller can compute the values of the actual parameters of the call and place them on top of its own activation record, without having to create the entire activation record of the callee, or even to know the layout of that record. Moreover, it allows for the use of procedures that do not always take the same number or type of arguments, such as C's `printf` function. The callee knows where to place the return value, relative to its own activation record, while however many arguments are present will appear sequentially below that place on the stack.
2. Fixed-length items are generally placed in the middle. From Fig. 7.5, such items typically include the control link, the access link, and the machine status fields. If exactly the same components of the machine status are saved for each call, then the same code can do the saving and restoring for each. Moreover, if we standardize the machine's status information, then programs such as debuggers will have an easier time deciphering the stack contents if an error occurs.
3. Items whose size may not be known early enough are placed at the end of the activation record. Most local variables have a fixed length, which

can be determined by the compiler by examining the type of the variable. However, some local variables have a size that cannot be determined until the program executes; the most common example is a dynamically sized array, where the value of one of the callee's parameters determines the length of the array. Moreover, the amount of space needed for temporaries usually depends on how successful the code-generation phase is in keeping temporaries in registers. Thus, while the space needed for temporaries is eventually known to the compiler, it may not be known when the intermediate code is first generated.

4. We must locate the top-of-stack pointer judiciously. A common approach is to have it point to the end of the fixed-length fields in the activation record. Fixed-length data can then be accessed by fixed offsets, known to the intermediate-code generator, relative to the top-of-stack pointer. A consequence of this approach is that variable-length fields in the activation records are actually "above" the top-of-stack. Their offsets need to be calculated at run time, but they too can be accessed from the top-of-stack pointer, by using a positive offset.

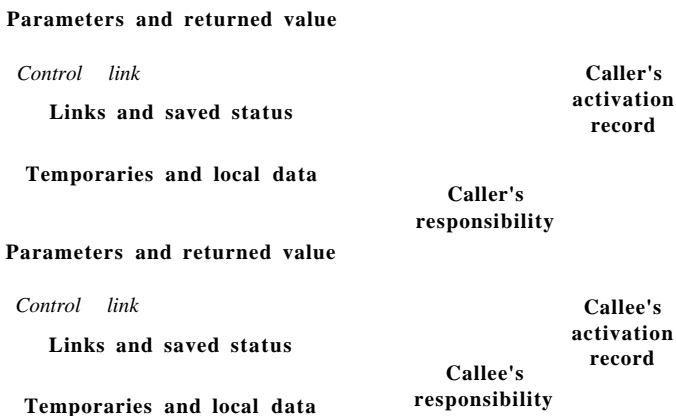

Figure 7.7: Division of tasks between caller and callee

An example of how caller and callee might cooperate in managing the stack is suggested by Fig. 7.7. A register *topsp* points to the end of the machine-status field in the current top activation record. This position within the callee's activation record is known to the caller, so the caller can be made responsible for setting *topsp* before control is passed to the callee. The calling sequence and its division between caller and callee is as follows:

1. The caller evaluates the actual parameters.

2. The caller stores a return address and the old value of *topsp* into the callee's activation record. The caller then increments *topsp* to the position shown in Fig. 7.7. That is, *topsp* is moved past the caller's local data and temporaries and the callee's parameters and status fields.
3. The callee saves the register values and other status information.
4. The callee initializes its local data and begins execution.

A suitable, corresponding return sequence is:

1. The callee places the return value next to the parameters, as in Fig. 7.5.
2. Using information in the machine-status field, the callee restores *topsp* and other registers, and then branches to the return address that the caller placed in the status field.
3. Although *topsp* has been decremented, the caller knows where the return value is, relative to the current value of *topsp*; the caller therefore may use that value.

The above calling and return sequences allow the number of arguments of the called procedure to vary from call to call (e.g., as in C's `printf` function). Note that at compile time, the target code of the caller knows the number and types of arguments it is supplying to the callee. Hence the caller knows the size of the parameter area. The target code of the callee, however, must be prepared to handle other calls as well, so it waits until it is called and then examines the parameter field. Using the organization of Fig. 7.7, information describing the parameters must be placed next to the status field, so the callee can find it. For example, in the `printf` function of C, the first argument describes the remaining arguments, so once the first argument has been located, the caller can find whatever other arguments there are.

### 7.2.4 Variable-Length Data on the Stack

The run-time memory-management system must deal frequently with the allocation of space for objects the sizes of which are not known at compile time, but which are local to a procedure and thus may be allocated on the stack. In modern languages, objects whose size cannot be determined at compile time are allocated space in the heap, the storage structure that we discuss in Section 7.4. However, it is also possible to allocate objects, arrays, or other structures of unknown size on the stack, and we discuss here how to do so. The reason to prefer placing objects on the stack if possible is that we avoid the expense of garbage collecting their space. Note that the stack can be used only for an object if it is local to a procedure and becomes inaccessible when the procedure returns.

A common strategy for allocating variable-length arrays (i.e., arrays whose size depends on the value of one or more parameters of the called procedure) is

shown in Fig. 7.8. The same scheme works for objects of any type if they are local to the procedure called and have a size that depends on the parameters of the call.

In Fig. 7.8, procedure  $p$  has three local arrays, whose sizes we suppose cannot be determined at compile time. The storage for these arrays is not part of the activation record for  $p$ , although it does appear on the stack. Only a pointer to the beginning of each array appears in the activation record itself. Thus, when  $p$  is executing, these pointers are at known offsets from the top-of-stack pointer, so the target code can access array elements through these pointers.

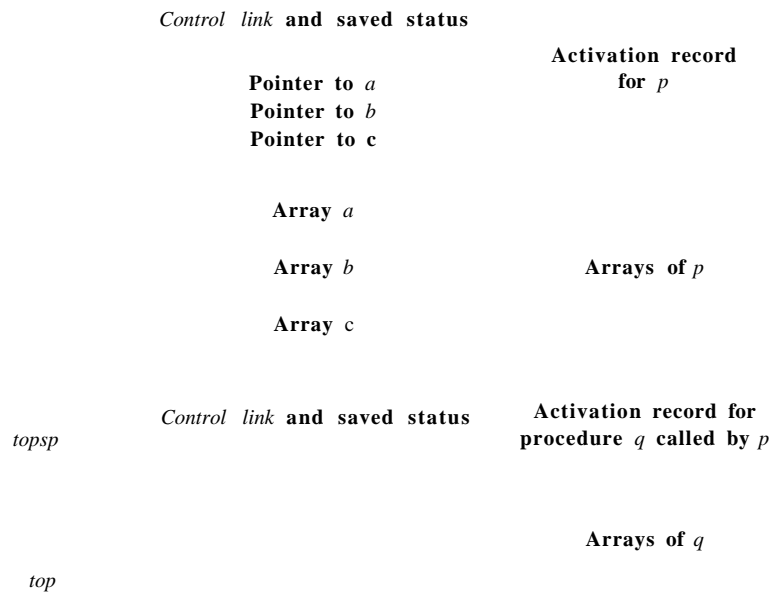

Figure 7.8: Access to dynamically allocated arrays

Also shown in Fig. 7.8 is the activation record for a procedure  $q$ , called by  $p$ . The activation record for  $q$  begins after the arrays of  $p$ , and any variable-length arrays of  $q$  are located beyond that.

Access to the data on the stack is through two pointers,  $top$  and  $topsp$ . Here,  $top$  marks the actual top of stack; it points to the position at which the next activation record will begin. The second,  $topsp$  is used to find local, fixed-length fields of the top activation record. For consistency with Fig. 7.7, we shall suppose that  $topsp$  points to the end of the machine-status field. In Fig. 7.8,  $topsp$  points to the end of this field in the activation record for  $q$ . From there, we can find the control-link field for  $q$ , which leads us to the place in the activation record for  $p$  where  $topsp$  pointed when  $p$  was on top.

The code to reposition  $top$  and  $topsp$  can be generated at compile time,

in terms of sizes that will become known at run time. When  $q$  returns,  $topsp$  can be restored from the saved control link in the activation record for  $q$ . The new value of  $top$  is (the old unrestored value of)  $topsp$  minus the length of the machine-status, control and access link, return-value, and parameter fields (as in Fig. 7.5) in  $q$ 's activation record. This length is known at compile time to the caller, although it may depend on the caller, if the number of parameters can vary across calls to  $q$ .

## 7.2.5 Exercises for Section 7.2

**Exercise 7.2.1:** Suppose that the program of Fig. 7.2 uses a *partition* function that always picks  $a[m]$  as the separator  $v$ . Also, when the array  $a[m], \dots, a[n]$  is reordered, assume that the order is preserved as much as possible. That is, first come all the elements less than  $v$ , in their original order, then all elements equal to  $v$ , and finally all elements greater than  $v$ , in their original order.

- a) Draw the activation tree when the numbers 9,8,7,6,5,4,3,2,1 are sorted.
- b) What is the largest number of activation records that ever appear together on the stack?

**Exercise 7.2.2:** Repeat Exercise 7.2.1 when the initial order of the numbers is 1,3,5,7,9,2,4,6,8.

**Exercise 7.2.3:** In Fig. 7.9 is C code to compute Fibonacci numbers recursively. Suppose that the activation record for  $f$  includes the following elements in order: (return value, argument  $n$ , local  $s$ , local  $t$ ); there will normally be other elements in the activation record as well. The questions below assume that the initial call is  $f(5)$ .

- a) Show the complete activation tree.
- b) What does the stack and its activation records look like the first time  $f(1)$  is about to return?
- c) What does the stack and its activation records look like the fifth time  $f(1)$  is about to return?

**Exercise 7.2.4:** Here is a sketch of two C functions  $f$  and  $g$ :

```
int f(int x) { int i; ... return i+1; ... }
int g(int y) { int j; ... f(j+D ... 1
```

That is, function  $g$  calls  $f$ . Draw the top of the stack, starting with the activation record for  $g$ , after  $g$  calls  $f$ , and  $f$  is about to return. You can consider only return values, parameters, control links, and space for local variables; you do not have to consider stored state or temporary or local values not shown in the code sketch. However, you should indicate:

```

int f(int n) {
    int t, s;
    if (n < 2) return 1;
    s = f(n-1);
    t = f(n-2);
    return s+t;
}

```

Figure 7.9: Fibonacci program for Exercise 7.2.3

- a) Which function creates the space on the stack for each element?
- b) Which function writes the value of each element?
- c) To which activation record does the element belong?

Exercise 7.2.5 : In a language that passes parameters by reference, there is a function  $f(x,y)$  that does the following:

```
x = x + 1 ; y = y + 2; return x+y;
```

If  $a$  is assigned the value 3, and then  $f(a, a)$  is called, what is returned?

Exercise 7.2.6: The C function  $f$  is defined by:

```

int f(int x, *py, **ppz) {
    **ppz += 1; *py +=2; x += 3; return x+y+z;
}

```

Variable  $a$  is a pointer to 6; variable 6 is a pointer to  $c$ , and  $c$  is an integer currently with value 4. If we call  $f(c, 6, a)$ , what is returned?

## 7.3 Access to Nonlocal Data on the Stack

In this section, we consider how procedures access their data. Especially important is the mechanism for finding data used within a procedure  $p$  but that does not belong to  $p$ . Access becomes more complicated in languages where procedures can be declared inside other procedures. We therefore begin with the simple case of C functions, and then introduce a language, ML, that permits both nested function declarations and functions as "first-class objects;" that is, functions can take functions as arguments and return functions as values. This capability can be supported by modifying the implementation of the run-time stack, and we shall consider several options for modifying the stack frames of Section 7.2.



### 7.3.1 Data Access Without Nested Procedures

In the C family of languages, all variables are defined either within a single function or outside any function ("globally"). Most importantly, it is impossible to declare one procedure whose scope is entirely within another procedure. Rather, a global variable  $v$  has a scope consisting of all the functions that follow the declaration of  $v$ , except where there is a local definition of the identifier  $v$ . Variables declared within a function have a scope consisting of that function only, or part of it, if the function has nested blocks, as discussed in Section 1.6.3.

For languages that do not allow nested procedure declarations, allocation of storage for variables and access to those variables is simple:

1. Global variables are allocated static storage. The locations of these variables remain fixed and are known at compile time. So to access any variable that is not local to the currently executing procedure, we simply use the statically determined address.
2. Any other name must be local to the activation at the top of the stack. We may access these variables through the *topsp* pointer of the stack.

An important benefit of static allocation for globals is that declared procedures may be passed as parameters or returned as results (in C, a pointer to the function is passed), with no substantial change in the data-access strategy. With the C static-scoping rule, and without nested procedures, any name non-local to one procedure is nonlocal to all procedures, regardless of how they are activated. Similarly, if a procedure is returned as a result, then any nonlocal name refers to the storage statically allocated for it.

### 7.3.2 Issues With Nested Procedures

Access becomes far more complicated when a language allows procedure declarations to be nested and also uses the normal static scoping rule; that is, a procedure can access variables of the procedures whose declarations surround its own declaration, following the nested scoping rule described for blocks in Section 1.6.3. The reason is that knowing at compile time that the declaration of  $p$  is immediately nested within  $q$  does not tell us the relative positions of their activation records at run time. In fact, since either  $p$  or  $q$  or both may be recursive, there may be several activation records of  $p$  and/or  $q$  on the stack.

Finding the declaration that applies to a nonlocal name  $x$  in a nested procedure  $p$  is a static decision; it can be done by an extension of the static-scope rule for blocks. Suppose  $x$  is declared in the enclosing procedure  $q$ . Finding the relevant activation of  $q$  from an activation of  $p$  is a dynamic decision; it requires additional run-time information about activations. One possible solution to this problem is to use "access links," which we introduce in Section 7.3.5.

### 7.3.3 A Language With Nested Procedure Declarations

The C family of languages, and many other familiar languages do not support nested procedures, so we introduce one that does. The history of nested procedures in languages is long. Algol 60, an ancestor of C, had this capability, as did its descendant Pascal, a once-popular teaching language. Of the later languages with nested procedures, one of the most influential is ML, and it is this language whose syntax and semantics we shall borrow (see the box on "More about ML" for some of the interesting features of ML):

- ML is a *functional language*, meaning that variables, once declared and initialized, are not changed. There are only a few exceptions, such as the array, whose elements can be changed by special function calls.
- Variables are defined, and have their unchangeable values initialized, by a statement of the form:

```
val (name) = (expression)
```

- Functions are defined using the syntax:

```
fun (name) ( (arguments) ) = (body)
```

- For function bodies we shall use let-statements of the form:

```
let (list of definitions) in (statements) end
```

The definitions are normally `val` or `fun` statements. The scope of each such definition consists of all following definitions, up to the `in`, and all the statements up to the `end`. Most importantly, function definitions can be nested. For example, the body of a function  $p$  can contain a `let`-statement that includes the definition of another (nested) function  $q$ . Similarly,  $q$  can have function definitions within its own body, leading to arbitrarily deep nesting of functions.

### 7.3.4 Nesting Depth

Let us give *nesting depth* 1 to procedures that are not nested within any other procedure. For example, all C functions are at nesting depth 1. However, if a procedure  $p$  is defined immediately within a procedure at nesting depth  $i$ , then give  $p$  the nesting depth  $i + 1$ .

**Example 7.5:** Figure 7.10 contains a sketch in ML of our running quicksort example. The only function at nesting depth 1 is the outermost function, `sort`, which reads an array `a` of 9 integers and sorts them using the quicksort algorithm. Defined within `sort`, at line (2), is the array `a` itself. Notice the form

## More About ML

In addition to being almost purely functional, ML presents a number of other surprises to the programmer who is used to C and its family.

- ML supports *higher-order functions*. That is, a function can take functions as arguments, and can construct and return other functions. Those functions, in turn, can take functions as arguments, to any level.
- ML has essentially no iteration, as in C's for- and while-statements, for instance. Rather, the effect of iteration is achieved by recursion. This approach is essential in a functional language, since we cannot change the value of an iteration variable like  $i$  in "for( $i=0$ ;  $i<10$ ;  $i++$ )" of C. Instead, ML would make  $i$  a function argument, and the function would call itself with progressively higher values of  $i$  until the limit was reached.
- ML supports lists and labeled tree structures as primitive data types.
- ML does not require declaration of variable types. Rather, it deduces types at compile time, and treats it as an error if it cannot. For example, `val x = 1` evidently makes  $x$  have integer type, and if we also see `val y = 2*x`, then we know  $y$  is also an integer.

of the ML declaration. The first argument of `array` says we want the array to have 11 elements; all ML arrays are indexed by integers starting with 0, so this array is quite similar to the C array  $a$  from Fig. 7.2. The second argument of `array` says that initially, all elements of the array  $a$  hold the value 0. This choice of initial value lets the ML compiler deduce that  $a$  is an integer array, since 0 is an integer, so we never have to declare a type for  $a$ .

Also declared within `sort` are several functions: `readArray`, `exchange`, and `quicksort`. On lines (4) and (6) we suggest that `readArray` and `exchange` each access the array  $a$ . Note that in ML, array accesses can violate the functional nature of the language, and both these functions actually change values of  $a$ 's elements, as in the C version of `quicksort`. Since each of these three functions is defined immediately within a function at nesting depth 1, their nesting depths are all 2.

Lines (7) through (11) show some of the detail of `quicksort`. Local value  $v$ , the pivot for the partition, is declared at line (8). Function `partition` is defined at line (9). In line (10) we suggest that `partition` accesses both the array  $a$  and the pivot value  $v$ , and also calls the function `exchange`. Since `partition` is defined immediately within a function at nesting depth 2, it is at depth 3. Line

```

1) fun sort(inputFile, outputFile) =
    let
2)     val a = array(11,0);
3)     fun readArray(inputFile) = ... ;
4)         ... a ... ;
5)     fun exchanged(j) =
6)         ... a ... ;
7)     fun quicksort(m,n) =
        let
8)         val v = ... ;
9)         fun partition(y,z) =
10)            ... a ... v ... exchange ...
        in
11)            ... a ... v ... partition ... quicksort
        end
    in
12)        ... a ... readArray ... quicksort ...
    end;

```

Figure 7.10: A version of quicksort, in ML style, using nested functions

(11) suggests that *quicksort* accesses variables *a* and *v*, the function *partition*, and itself recursively.

Line (12) suggests that the outer function *sort* accesses *a* and calls the two procedures *readArray* and *quicksort*. •

### 7.3.5 Access Links

A direct implementation of the normal static scope rule for nested functions is obtained by adding a pointer called the *access link* to each activation record. If procedure *p* is nested immediately within procedure *q* in the source code, then the access link in any activation of *p* points to the most recent activation of *q*. Note that the nesting depth of *q* must be exactly one less than the nesting depth of *p*. Access links form a chain from the activation record at the top of the stack to a sequence of activations at progressively lower nesting depths. Along this chain are all the activations whose data and procedures are accessible to the currently executing procedure.

Suppose that the procedure *p* at the top of the stack is at nesting depth  $n_p$  and *p* needs to access *x*, which is an element defined within some procedure *q* that surrounds *p* and has nesting depth  $n_q$ . Note that  $n_q < n_p$ , with equality only if *p* and *q* are the same procedure. To find *x*, we start at the activation record for *p* at the top of the stack and follow the access link  $n_p - n_q$  times, from activation record to activation record. Finally, we wind up at an activation record for *q*, and it will always be the most recent (highest) activation record

for  $q$  that currently appears on the stack. This activation record contains the element  $x$  that we want. Since the compiler knows the layout of activation records,  $x$  will be found at some fixed offset from the position in  $g$ 's activation record that we can reach by following the last access link.

Example 7.6: Figure 7.11 shows a sequence of stacks that might result from execution of the function *sort* of Fig. 7.10. As before, we represent function names by their first letters, and we show some of the data that might appear in the various activation records, as well as the access link for each activation. In Fig. 7.11(a), we see the situation after *sort* has called *readArray* to load input into the array  $a$  and then called *quicksort*( $l, 9$ ) to sort the array. The access link from *quicksort*( $l, 9$ ) points to the activation record for *sort*, not because *sort* called *quicksort* but because *sort* is the most closely nested function surrounding *quicksort* in the program of Fig. 7.10.

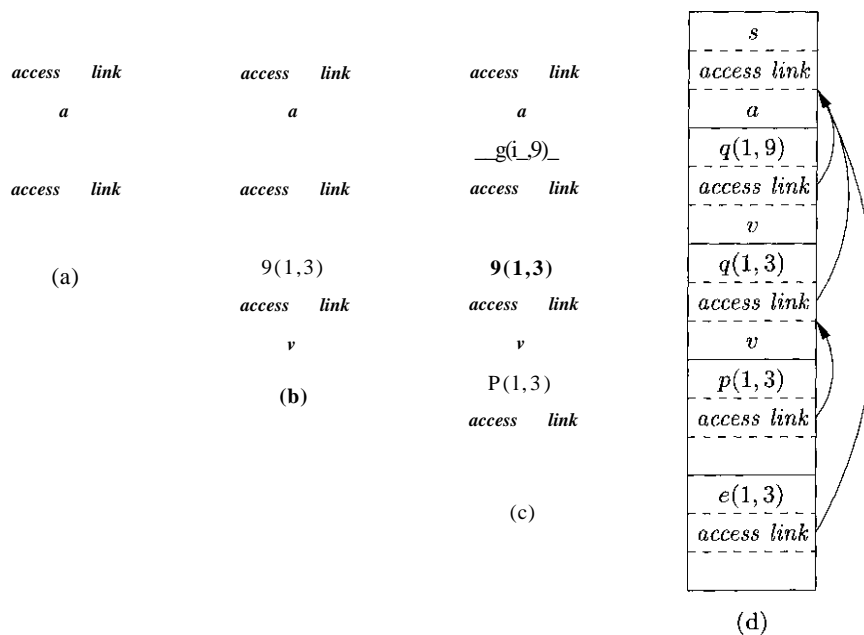

Figure 7.11: Access links for finding nonlocal data

In successive steps of Fig. 7.11 we see a recursive call to *quicksort*( $l, 3$ ), followed by a call to *partition*, which calls *exchange*. Notice that *quicksort*( $l, 3$ )'s access link points to *sort*, for the same reason that *quicksort*( $l, 9$ )'s does.

In Fig. 7.11(d), the access link for *exchange* bypasses the activation records for *quicksort* and *partition*, since *exchange* is nested immediately within *sort*. That arrangement is fine, since *exchange* needs to access only the array  $a$ , and the two elements it must swap are indicated by its own parameters  $i$  and  $j$ . •

### 7.3.6 Manipulating Access Links

How are access links determined? The simple case occurs when a procedure call is to a particular procedure whose name is given explicitly in the procedure call. The harder case is when the call is to a procedure-parameter; in that case, the particular procedure being called is not known until run time, and the nesting depth of the called procedure may differ in different executions of the call. Thus, let us first consider what should happen when a procedure  $q$  calls procedure  $p$ , explicitly. There are three cases:

1. Procedure  $p$  is at a higher nesting depth than  $q$ . Then  $p$  must be defined immediately within  $q$ , or the call by  $q$  would not be at a position that is within the scope of the procedure name  $p$ . Thus, the nesting depth of  $p$  is exactly one greater than that of  $q$ , and the access link from  $p$  must lead to  $q$ . It is a simple matter for the calling sequence to include a step that places in the access link for  $p$  a pointer to the activation record of  $q$ . Examples include the call of *quicksort* by *sort* to set up Fig. 7.11(a), and the call of *partition* by *quicksort* to create Fig. 7.11(c).
2. The call is recursive, that is,  $p = q$ ? Then the access link for the new activation record is the same as that of the activation record below it. An example is the call of *quicksort*( $l, 3$ ) by *quicksort*( $l, 9$ ) to set up Fig. 7.11(b).
3. The nesting depth  $n_p$  of  $p$  is less than the nesting depth  $n_q$  of  $q$ . In order for the call within  $q$  to be in the scope of name  $p$ , procedure  $q$  must be nested within some procedure  $r$ , while  $p$  is a procedure defined immediately within  $r$ . The top activation record for  $r$  can therefore be found by following the chain of access links, starting in the activation record for  $q$ , for  $n_q - n_p + 1$  hops. Then, the access link for  $p$  must go to this activation of  $r$ .

**Example 7.7:** For an example of case (3), notice how we go from Fig. 7.11(c) to Fig. 7.11(d). The nesting depth 2 of the called function *exchange* is one less than the depth 3 of the calling function *partition*. Thus, we start at the activation record for *partition* and follow  $3 - 2 + 1 = 2$  access links, which takes us from *partition*'s activation record to that of *quicksort*( $l, S$ ) to that of *sort*. The access link for *exchange* therefore goes to the activation record for *sort*, as we see in Fig. 7.11(d).

An equivalent way to discover this access link is simply to follow access links for  $n_q - n_p$  hops, and copy the access link found in that record. In our example, we would go one hop to the activation record for *quicksort*( $l, 3$ ) and copy its access link to *sort*. Notice that this access link is correct for *exchange*, even though *exchange* is not in the scope of *quicksort*, these being sibling functions nested within *sort*. •

<sup>3</sup>ML allows mutually recursive functions, which would be handled the same way.

### 7.3.7 Access Links for Procedure Parameters

When a procedure  $p$  is passed to another procedure  $q$  as a parameter, and  $q$  then calls its parameter (and therefore calls  $p$  in this activation of  $q$ ), it is possible that  $q$  does not know the context in which  $p$  appears in the program. If so, it is impossible for  $q$  to know how to set the access link for  $p$ . The solution to this problem is as follows: when procedures are used as parameters, the caller needs to pass, along with the name of the procedure-parameter, the proper access link for that parameter.

The caller always knows the link, since if  $p$  is passed by procedure  $r$  as an actual parameter, then  $p$  must be a name accessible to  $r$ , and therefore,  $r$  can determine the access link for  $p$  exactly as if  $p$  were being called by  $r$  directly. That is, we use the rules for constructing access links given in Section 7.3.6.

**Example 7.8:** In Fig. 7.12 we see a sketch of an ML function  $a$  that has functions  $b$  and  $c$  nested within it. Function  $b$  has a function-valued parameter  $/$ , which it calls. Function  $c$  defines within it a function  $d$ , and  $c$  then calls  $b$  with actual parameter  $d$ .

```

fun a(x) =
  let
    fun b(f) =
      ... ε ...
    fun c(y) =
      let
        fun d(z) = ...
      in
        ... b(d) ...
      end
    in
      ... c(i) ...
  end;

```

Figure 7.12: Sketch of ML program that uses function-parameters

Let us trace what happens when  $a$  is executed. First,  $a$  calls  $c$ , so we place an activation record for  $c$  above that for  $a$  on the stack. The access link for  $c$  points to the record for  $a$ , since  $c$  is defined immediately within  $a$ . Then  $c$  calls  $b(d)$ . The calling sequence sets up an activation record for  $b$ , as shown in Fig. 7.13(a).

Within this activation record is the actual parameter  $d$  and its access link, which together form the value of formal parameter  $/$  in the activation record for  $b$ . Notice that  $c$  knows about  $d$ , since  $d$  is defined within  $c$ , and therefore  $c$  passes a pointer to its own activation record as the access link. No matter where  $d$  was defined, if  $c$  is in the scope of that definition, then one of the three rules of Section 7.3.6 must apply, and  $c$  can provide the link.

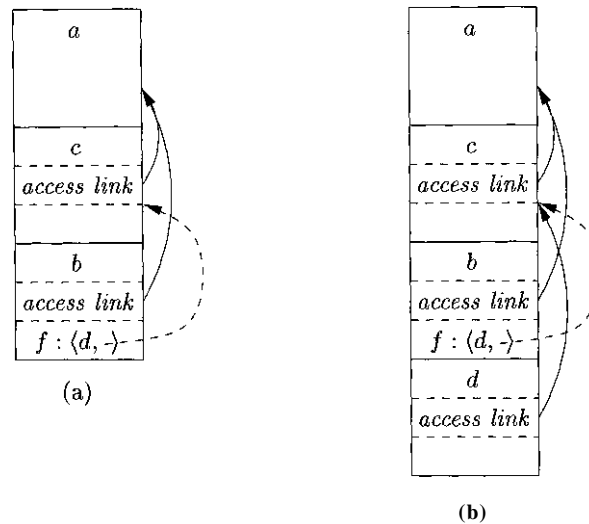

Figure 7.13: Actual parameters carry their access link with them

Now, let us look at what  $b$  does. We know that at some point, it uses its parameter  $/$ , which has the effect of calling  $d$ . An activation record for  $d$  appears on the stack, as shown in Fig. 7.13(b). The proper access link to place in this activation record is found in the value for parameter  $/$ ; the link is to the activation record for  $c$ , since  $c$  immediately surrounds the definition of  $d$ . Notice that  $b$  is capable of setting up the proper link, even though  $b$  is not in the scope of  $c$ 's definition. •

### 7.3.8 Displays

One problem with the access-link approach to nonlocal data is that if the nesting depth gets large, we may have to follow long chains of links to reach the data we need. A more efficient implementation uses an auxiliary array  $d$ , called the *display*, which consists of one pointer for each nesting depth. We arrange that, at all times,  $d[i]$  is a pointer to the highest activation record on the stack for any procedure at nesting depth  $i$ . Examples of a display are shown in Fig. 7.14. For instance, in Fig. 7.14(d), we see the display  $d$ , with  $d[1]$  holding a pointer to the activation record for *sort*, the highest (and only) activation record for a function at nesting depth 1. Also,  $d[2]$  holds a pointer to the activation record for *exchange*, the highest record at depth 2, and  $d[3]$  points to *partition*, the highest record at depth 3.

The advantage of using a display is that if procedure  $p$  is executing, and it needs to access element  $x$  belonging to some procedure  $q$ , we need to look only in  $d[i]$ , where  $i$  is the nesting depth of  $q$ ; we follow the pointer  $d[i]$  to the activation record for  $q$ , wherein  $x$  is found at a known offset. The compiler knows what  $i$  is, so it can generate code to access  $x$  using  $d[i]$  and the offset of



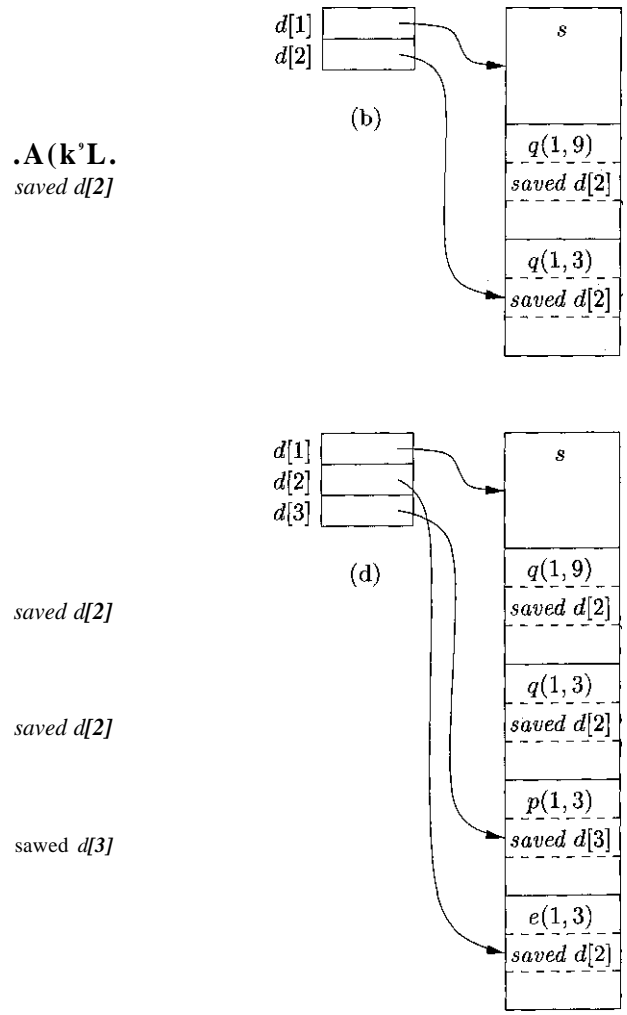

Figure 7.14: Maintaining the display

$x$  from the top of the activation record for  $q$ . Thus, the code never needs to follow a long chain of access links.

In order to maintain the display correctly, we need to save previous values of display entries in new activation records. If procedure  $p$  at depth  $n_p$  is called, and its activation record is not the first on the stack for a procedure at depth  $n_p$ , then the activation record for  $p$  needs to hold the previous value of  $d[n_p]$ , while  $d[n_p]$  itself is set to point to this activation of  $p$ . When  $p$  returns, and its activation record is removed from the stack, we restore  $d[n_p]$  to have its value prior to the call of  $p$ .

**Example 7.9:** Several steps of manipulating the display are illustrated in Fig. 7.14. In Fig. 7.14(a), *sort* at depth 1 has called *quicksort*( $l$ , 9) at depth 2. The activation record for *quicksort* has a place to store the old value of  $d[2]$ , indicated as *saved  $d[2]$* , although in this case since there was no prior activation record at depth 2, this pointer is null.

In Fig. 7.14(b), *quicksort*( $l$ , 9) calls *quicksort*( $l$ , 3). Since the activation records for both calls are at depth 2, we must store the pointer to *quicksort*( $l$ , 9), which was in  $d[2]$ , in the record for *quicksort*( $l$ , 3). Then,  $d[2]$  is made to point to *quicksort*( $l$ , 3).

Next, *partition* is called. This function is at depth 3, so we use the slot  $d[3]$  in the display for the first time, and make it point to the activation record for *partition*. The record for *partition* has a slot for a former value of  $d[3]$ , but in this case there is none, so the pointer remains null. The display and stack at this time are shown in Fig. 7.14(c).

Then, *partition* calls *exchange*. That function is at depth 2, so its activation record stores the old pointer  $d[2]$ , which goes to the activation record for *quicksort*( $l$ , 3). Notice that the display pointers "cross"; that is,  $d[3]$  points further down the stack than  $d[2]$  does. However, that is a proper situation; *exchange* can only access its own data and that of *sort*, via  $d[1]$ . •

### 7.3.9 Exercises for Section 7.3

**Exercise 7.3.1:** In Fig. 7.15 is a ML function *main* that computes Fibonacci numbers in a nonstandard way. Function *fibO* will compute the  $n$ th Fibonacci number for any  $n > 0$ . Nested within in is *fib1*, which computes the  $n$ th Fibonacci number on the assumption  $n > 2$ , and nested within *fib1* is *fib2*, which assumes  $n > 4$ . Note that neither *fib1* nor *fib2* need to check for the basis cases. Show the stack of activation records that result from a call to *main*, up until the time that the first call (to *fibO*(1)) is about to return. Show the access link in each of the activation records on the stack.

**Exercise 7.3.2:** Suppose that we implement the functions of Fig. 7.15 using a display. Show the display at the moment the first call to *fibO*(1) is about to return. Also, indicate the saved display entry in each of the activation records on the stack at that time.

```
fun main () {
  let
    fun fibO(n) =
      let
        fun fib1(n) =
          let
            fun fib2(n) = fib1(n-1) + fib1(n-2)
          in
            if n >= 4 then fib2(n)
            else fibO(n-1) + fibO(n-2)
          end
        in
          if n >= 2 then fib1(n)
          else 1
        end
      in
        fib0(4)
    end;
end;
```

Figure 7.15: Nested functions computing Fibonacci numbers

## 7.4 Heap Management

The heap is the portion of the store that is used for data that lives indefinitely, or until the program explicitly deletes it. While local variables typically become inaccessible when their procedures end, many languages enable us to create objects or other data whose existence is not tied to the procedure activation that creates them. For example, both C++ and Java give the programmer new to create objects that may be passed — or pointers to them may be passed — from procedure to procedure, so they continue to exist long after the procedure that created them is gone. Such objects are stored on a heap.

In this section, we discuss the *memory manager*, the subsystem that allocates and deallocates space within the heap; it serves as an interface between application programs and the operating system. For languages like C or C++ that deallocate chunks of storage *manually* (i.e., by explicit statements of the program, such as `free` or `delete`), the memory manager is also responsible for implementing deallocation.

In Section 7.5, we discuss *garbage collection*, which is the process of finding spaces within the heap that are no longer used by the program and can therefore be reallocated to house other data items. For languages like Java, it is the garbage collector that deallocates memory. When it is required, the garbage collector is an important subsystem of the memory manager.

### 7.4.1 The Memory Manager

The memory manager keeps track of all the free space in heap storage at all times. It performs two basic functions:

- *Allocation.* When a program requests memory for a variable or object,<sup>3</sup> the memory manager produces a chunk of contiguous heap memory of the requested size. If possible, it satisfies an allocation request using free space in the heap; if no chunk of the needed size is available, it seeks to increase the heap storage space by getting consecutive bytes of virtual memory from the operating system. If space is exhausted, the memory manager passes that information back to the application program.
- *Deallocation.* The memory manager returns deallocated space to the pool of free space, so it can reuse the space to satisfy other allocation requests. Memory managers typically do not return memory to the operating system, even if the program's heap usage drops.

Memory management would be simpler if (a) all allocation requests were for chunks of the same size, and (b) storage were released predictably, say, first-allocated first-deallocated. There are some languages, such as Lisp, for which condition (a) holds; pure Lisp uses only one data element — a two-pointer cell — from which all data structures are built. Condition (b) also holds in some situations, the most common being data that can be allocated on the run-time stack. However, in most languages, neither (a) nor (b) holds in general. Rather, data elements of different sizes are allocated, and there is no good way to predict the lifetimes of all allocated objects.

Thus, the memory manager must be prepared to service, in any order, allocation and deallocation requests of any size, ranging from one byte to as large as the program's entire address space.

Here are the properties we desire of memory managers:

- *Space Efficiency.* A memory manager should minimize the total heap space needed by a program. Doing so allows larger programs to run in a fixed virtual address space. Space efficiency is achieved by minimizing "fragmentation," discussed in Section 7.4.4.
- *Program Efficiency.* A memory manager should make good use of the memory subsystem to allow programs to run faster. As we shall see in Section 7.4.2, the time taken to execute an instruction can vary widely depending on where objects are placed in memory. Fortunately, programs tend to exhibit "locality," a phenomenon discussed in Section 7.4.3, which refers to the nonrandom clustered way in which typical programs access memory. By attention to the placement of objects in memory, the memory manager can make better use of space and, hopefully, make the program run faster.

<sup>3</sup>In what follows, we shall refer to things requiring memory space as "objects," even if they are not true objects in the "object-oriented programming" sense.

- *Low Overhead.* Because memory allocations and deallocations are frequent operations in many programs, it is important that these operations be as efficient as possible. That is, we wish to minimize the *overhead* — the fraction of execution time spent performing allocation and deallocation. Notice that the cost of allocations is dominated by small requests; the overhead of managing large objects is less important, because it usually can be amortized over a larger amount of computation.

## 7.4.2 The Memory Hierarchy of a Computer

Memory management and compiler optimization must be done with an awareness of how memory behaves. Modern machines are designed so that programmers can write correct programs without concerning themselves with the details of the memory subsystem. However, the efficiency of a program is determined not just by the number of instructions executed, but also by how long it takes to execute each of these instructions. The time taken to execute an instruction can vary significantly, since the time taken to access different parts of memory can vary from nanoseconds to milliseconds. Data-intensive programs can therefore benefit significantly from optimizations that make good use of the memory subsystem. As we shall see in Section 7.4.3, they can take advantage of the phenomenon of "locality" — the nonrandom behavior of typical programs.

The large variance in memory access times is due to the fundamental limitation in hardware technology; we can build small and fast storage, or large and slow storage, but not storage that is both large and fast. It is simply impossible today to build gigabytes of storage with nanosecond access times, which is how fast high-performance processors run. Therefore, practically all modern computers arrange their storage as a *memory hierarchy*. A memory hierarchy, as shown in Fig. 7.16, consists of a series of storage elements, with the smaller faster ones "closer" to the processor, and the larger slower ones further away.

Typically, a processor has a small number of registers, whose contents are under software control. Next, it has one or more levels of cache, usually made out of static RAM, that are kilobytes to several megabytes in size. The next level of the hierarchy is the physical (main) memory, made out of hundreds of megabytes or gigabytes of dynamic RAM. The physical memory is then backed up by virtual memory, which is implemented by gigabytes of disks. Upon a memory access, the machine first looks for the data in the closest (lowest-level) storage and, if the data is not there, looks in the next higher level, and so on.

Registers are scarce, so register usage is tailored for the specific applications and managed by the code that a compiler generates. All the other levels of the hierarchy are managed automatically; in this way, not only is the programming task simplified, but the same program can work effectively across machines with different memory configurations. With each memory access, the machine searches each level of the memory in succession, starting with the lowest level, until it locates the data. Caches are managed exclusively in hardware, in order to keep up with the relatively fast RAM access times. Because disks are rela-

Typical Sizes		Typical Access Times
> 2GB	Virtual Memory (Disk)	3 - 15 ms
256MB - 2GB	Physical Memory	100 - 150 ns
128KB - 4MB	2nd-Level Cache	40 - 60 ns
16 - 64KB	1st-Level Cache	5 - 10 ns
32 Words	Registers (Processor)	1 ns

Figure 7.16: Typical Memory Hierarchy Configurations

tively slow, the virtual memory is managed by the operating system, with the assistance of a hardware structure known as the "translation lookaside buffer."

Data is transferred as blocks of contiguous storage. To amortize the cost of access, larger blocks are used with the slower levels of the hierarchy. Between main memory and cache, data is transferred in blocks known as *cache lines*, which are typically from 32 to 256 bytes long. Between virtual memory (disk) and main memory, data is transferred in blocks known as *pages*, typically between 4K and 64K bytes in size.

### 7.4.3 Locality in Programs

Most programs exhibit a high degree of *locality*; that is, they spend most of their time executing a relatively small fraction of the code and touching only a small fraction of the data. We say that a program has *temporal locality* if the memory locations it accesses are likely to be accessed again within a short period of time. We say that a program has *spatial locality* if memory locations close to the location accessed are likely also to be accessed within a short period of time.

The conventional wisdom is that programs spend 90% of their time executing 10% of the code. Here is why:

- Programs often contain many instructions that are never executed. Programs built with components and libraries use only a small fraction of the provided functionality. Also as requirements change and programs evolve, legacy systems often contain many instructions that are no longer used.

## Static and Dynamic RAM

Most random-access memory is *dynamic*, which means that it is built of very simple electronic circuits that lose their charge (and thus "forget" the bit they were storing) in a short time. These circuits need to be refreshed — that is, their bits read and rewritten — periodically. On the other hand, *static* RAM is designed with a more complex circuit for each bit, and consequently the bit stored can stay indefinitely, until it is changed. Evidently, a chip can store more bits if it uses dynamic-RAM circuits than if it uses static-RAM circuits, so we tend to see large main memories of the dynamic variety, while smaller memories, like caches, are made from static circuits.

- Only a small fraction of the code that could be invoked is actually executed in a typical run of the program. For example, instructions to handle illegal inputs and exceptional cases, though critical to the correctness of the program, are seldom invoked on any particular run.
- The typical program spends most of its time executing innermost loops and tight recursive cycles in a program.

Locality allows us to take advantage of the memory hierarchy of a modern computer, as shown in Fig. 7.16. By placing the most common instructions and data in the fast-but-small storage, while leaving the rest in the slow-but-large storage, we can lower the average memory-access time of a program significantly.

It has been found that many programs exhibit both temporal and spatial locality in how they access both instructions and data. Data-access patterns, however, generally show a greater variance than instruction-access patterns. Policies such as keeping the most recently used data in the fastest hierarchy work well for common programs but may not work well for some data-intensive programs — ones that cycle through very large arrays, for example.

We often cannot tell, just from looking at the code, which sections of the code will be heavily used, especially for a particular input. Even if we know which instructions are executed heavily, the fastest cache often is not large enough to hold all of them at the same time. We must therefore adjust the contents of the fastest storage dynamically and use it to hold instructions that are likely to be used heavily in the near future.

### Optimization Using the Memory Hierarchy

The policy of keeping the most recently used instructions in the cache tends to work well; in other words, the past is generally a good predictor of future memory usage. When a new instruction is executed, there is a high probability that the next instruction also will be executed. This phenomenon is an

## Cache Architectures

How do we know if a cache line is in a cache? It would be too expensive to check every single line in the cache, so it is common practice to restrict the placement of a cache line within the cache. This restriction is known as *set associativity*. A cache is *k-way set associative* if a cache line can reside only in *k* locations. The simplest cache is a 1-way associative cache, also known as a *direct-mapped* cache. In a direct-mapped cache, data with memory address *n* can be placed only in cache address  $n \bmod s$ , where *s* is the size of the cache. Similarly, a *k*-way set associative cache is divided into *k* sets, where a datum with address *n* can be mapped only to the location  $n \bmod (s/k)$  in each set. Most instruction and data caches have associativity between 1 and 8. When a cache line is brought into the cache, and all the possible locations that can hold the line are occupied, it is typical to evict the line that has been the least recently used.

example of spatial locality. One effective technique to improve the spatial locality of instructions is to have the compiler place basic blocks (sequences of instructions that are always executed sequentially) that are likely to follow each other contiguously — on the same page, or even the same cache line, if possible. Instructions belonging to the same loop or same function also have a high probability of being executed together.<sup>4</sup>

We can also improve the temporal and spatial locality of data accesses in a program by changing the data layout or the order of the computation. For example, programs that visit large amounts of data repeatedly, each time performing a small amount of computation, do not perform well. It is better if we can bring some data from a slow level of the memory hierarchy to a faster level (e.g., disk to main memory) once, and perform all the necessary computations on this data while it resides at the faster level. This concept can be applied recursively to reuse data in physical memory, in the caches and in the registers.

### 7.4.4 Reducing Fragmentation

At the beginning of program execution, the heap is one contiguous unit of free space. As the program allocates and deallocates memory, this space is broken up into free and used chunks of memory, and the free chunks need not reside in a contiguous area of the heap. We refer to the free chunks of memory as *holes*. With each allocation request, the memory manager must *place* the requested chunk of memory into a large-enough hole. Unless a hole of exactly the right size is found, we need to *split* some hole, creating a yet smaller hole.

<sup>4</sup>As a machine fetches a word in memory, it is relatively inexpensive to *prefetch* the next several contiguous words of memory as well. Thus, a common memory-hierarchy feature is that a multiword block is fetched from a level of memory each time that level is accessed.



With each deallocation request, the freed chunks of memory are added back to the pool of free space. We *coalesce* contiguous holes into larger holes, as the holes can only get smaller otherwise. If we are not careful, the memory may end up getting *fragmented*, consisting of large numbers of small, noncontiguous holes. It is then possible that no hole is large enough to satisfy a future request, even though there may be sufficient aggregate free space.

#### Best-Fit and Next-Fit Object Placement

We reduce fragmentation by controlling how the memory manager places new objects in the heap. It has been found empirically that a good strategy for minimizing fragmentation for real-life programs is to allocate the requested memory in the smallest available hole that is large enough. This *best-fit* algorithm tends to spare the large holes to satisfy subsequent, larger requests. An alternative, called *first-fit*, where an object is placed in the first (lowest-address) hole in which it fits, takes less time to place objects, but has been found inferior to best-fit in overall performance.

To implement best-fit placement more efficiently, we can separate free space into *bins*, according to their sizes. One practical idea is to have many more bins for the smaller sizes, because there are usually many more small objects. For example, the Lea memory manager, used in the GNU C compiler gcc, aligns all chunks to 8-byte boundaries. There is a bin for every multiple of 8-byte chunks from 16 bytes to 512 bytes. Larger-sized bins are logarithmically spaced (i.e., the minimum size for each bin is twice that of the previous bin), and within each of these bins the chunks are ordered by their size. There is always a chunk of free space that can be extended by requesting more pages from the operating system. Called the *wilderness chunk*, this chunk is treated by Lea as the largest-sized bin because of its extensibility.

Binning makes it easy to find the best-fit chunk.

- If, as for small sizes requested from the Lea memory manager, there is a bin for chunks of that size only, we may take any chunk from that bin.
- For sizes that do not have a private bin, we find the one bin that is allowed to include chunks of the desired size. Within that bin, we can use either a first-fit or a best-fit strategy; i.e., we either look for and select the first chunk that is sufficiently large or, we spend more time and find the smallest chunk that is sufficiently large. Note that when the fit is not exact, the remainder of the chunk will generally need to be placed in a bin with smaller sizes.
- However, it may be that the target bin is empty, or all chunks in that bin are too small to satisfy the request for space. In that case, we simply repeat the search, using the bin for the next larger size(s). Eventually, we either find a chunk we can use, or we reach the "wilderness" chunk, from which we can surely obtain the needed space, possibly by going to the operating system and getting additional pages for the heap.

While best-fit placement tends to improve space utilization, it may not be the best in terms of spatial locality. Chunks allocated at about the same time by a program tend to have similar reference patterns and to have similar lifetimes. Placing them close together thus improves the program's spatial locality. One useful adaptation of the best-fit algorithm is to modify the placement in the case when a chunk of the exact requested size cannot be found. In this case, we use a *next-fit* strategy, trying to allocate the object in the chunk that has last been split, whenever enough space for the new object remains in that chunk. Next-fit also tends to improve the speed of the allocation operation.

### Managing and Coalescing Free Space

When an object is deallocated manually, the memory manager must make its chunk free, so it can be allocated again. In some circumstances, it may also be possible to combine (*coalesce*) that chunk with adjacent chunks of the heap, to form a larger chunk. There is an advantage to doing so, since we can always use a large chunk to do the work of small chunks of equal total size, but many small chunks cannot hold one large object, as the combined chunk could.

If we keep a bin for chunks of one fixed size, as Lea does for small sizes, then we may prefer not to coalesce adjacent blocks of that size into a chunk of double the size. It is simpler to keep all the chunks of one size in as many pages as we need, and never coalesce them. Then, a simple allocation/deallocation scheme is to keep a bitmap, with one bit for each chunk in the bin. A 1 indicates the chunk is occupied; 0 indicates it is free. When a chunk is deallocated, we change its 1 to a 0. When we need to allocate a chunk, we find any chunk with a 0 bit, change that bit to a 1, and use the corresponding chunk. If there are no free chunks, we get a new page, divide it into chunks of the appropriate size, and extend the bit vector.

Matters are more complex when the heap is managed as a whole, without binning, or if we are willing to coalesce adjacent chunks and move the resulting chunk to a different bin if necessary. There are two data structures that are useful to support coalescing of adjacent free blocks:

- *Boundary Tags.* At both the low and high ends of each chunk, whether free or allocated, we keep vital information. At both ends, we keep a free/used bit that tells whether or not the block is currently allocated (used) or available (free). Adjacent to each free/used bit is a count of the total number of bytes in the chunk.
- *A Doubly Linked, Embedded Free List.* The free chunks (but not the allocated chunks) are also linked in a doubly linked list. The pointers for this list are within the blocks themselves, say adjacent to the boundary tags at either end. Thus, no additional space is needed for the free list, although its existence does place a lower bound on how small chunks can get; they must accommodate two boundary tags and two pointers, even if the object is a single byte. The order of chunks on the free list is left

unspecified. For example, the list could be sorted by size, thus facilitating best-fit placement.

Example 7.10: Figure 7.17 shows part of a heap with three adjacent chunks, *A*, *B*, and *C*. Chunk *B* of size 100, has just been deallocated and returned to the free list. Since we know the beginning (left end) of *B*, we also know the end of the chunk that happens to be immediately to *B*'s left, namely *A* in this example. The free/used bit at the right end of *A* is currently 0, so *A* too is free. We may therefore coalesce *A* and *B* into one chunk of 300 bytes.

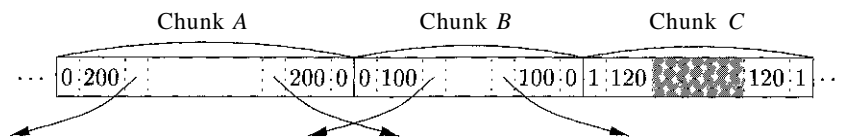

Figure 7.17: Part of a heap and a doubly linked free list

It might be the case that chunk *C*, the chunk immediately to *B*'s right, is also free, in which case we can combine all of *A*, *B*, and *C*. Note that if we always coalesce chunks when we can, then there can never be two adjacent free chunks, so we never have to look further than the two chunks adjacent to the one being deallocated. In the current case, we find the beginning of *C* by starting at the left end of *B*, which we know, and finding the total number of bytes in *B*, which is found in the left boundary tag of *B* and is 100 bytes. With this information, we find the right end of *B* and the beginning of the chunk to its right. At that point, we examine the free/used bit of *C* and find that it is 1 for used; hence, *C* is not available for coalescing.

Since we must coalesce *A* and *B*, we need to remove one of them from the free list. The doubly linked free-list structure lets us find the chunks before and after each of *A* and *B*. Notice that it should not be assumed that physical neighbors *A* and *B* are also adjacent on the free list. Knowing the chunks preceding and following *A* and *B* on the free list, it is straightforward to manipulate pointers on the list to replace *A* and *B* by one coalesced chunk. •

Automatic garbage collection can eliminate fragmentation altogether if it moves all the allocated objects to contiguous storage. The interaction between garbage collection and memory management is discussed in more detail in Section 7.6.4.

### 7.4.5 Manual Deallocation Requests

We close this section with manual memory management, where the programmer must explicitly arrange for the deallocation of data, as in C and C++. Ideally, any storage that will no longer be accessed should be deleted. Conversely, any storage that may be referenced must not be deleted. Unfortunately, it is hard to enforce either of these properties. In addition to considering the difficulties with

manual deallocation, we shall describe some of the techniques programmers use to help with the difficulties.

### Problems with Manual Deallocation

Manual memory management is error-prone. The common mistakes take two forms: failing ever to delete data that cannot be referenced is called a *memory-leak* error, and referencing deleted data is a *dangling-pointer-dereference* error.

It is hard for programmers to tell if a program *will never* refer to some storage in the future, so the first common mistake is not deleting storage that will never be referenced. Note that although memory leaks may slow down the execution of a program due to increased memory usage, they do not affect program correctness, as long as the machine does not run out of memory. Many programs can tolerate memory leaks, especially if the leakage is slow. However, for long-running programs, and especially nonstop programs like operating systems or server code, it is critical that they not have leaks.

Automatic garbage collection gets rid of memory leaks by deallocating all the garbage. Even with automatic garbage collection, a program may still use more memory than necessary. A programmer may know that an object will never be referenced, even though references to that object exist somewhere. In that case, the programmer must deliberately remove references to objects that will never be referenced, so the objects can be deallocated automatically.

Being overly zealous about deleting objects can lead to even worse problems than memory leaks. The second common mistake is to delete some storage and then try to refer to the data in the deallocated storage. Pointers to storage that has been deallocated are known as *dangling pointers*. Once the freed storage has been reallocated to a new variable, any read, write, or deallocation via the dangling pointer can produce seemingly random effects. We refer to any operation, such as read, write, or deallocate, that follows a pointer and tries to use the object it points to, as *dereferencing* the pointer.

Notice that reading through a dangling pointer may return an arbitrary value. Writing through a dangling pointer arbitrarily changes the value of the new variable. Deallocating a dangling pointer's storage means that the storage of the new variable may be allocated to yet another variable, and actions on the old and new variables may conflict with each other.

Unlike memory leaks, dereferencing a dangling pointer after the freed storage is reallocated almost always creates a program error that is hard to debug. As a result, programmers are more inclined not to deallocate a variable if they are not certain it is unreferenceable.

A related form of programming error is to access an illegal address. Common examples of such errors include dereferencing null pointers and accessing an out-of-bounds array element. It is better for such errors to be detected than to have the program silently corrupt the results. In fact, many security violations exploit programming errors of this type, where certain program inputs allow unintended access to data, leading to a "hacker" taking control of the program

### An Example: Purify

Rational's Purify is one of the most popular commercial tools that helps programmers find memory access errors and memory leaks in programs. Purify instruments binary code by adding additional instructions to check for errors as the program executes. It keeps a map of memory to indicate where all the freed and used spaces are. Each allocated object is bracketed with extra space; accesses to unallocated locations or to spaces between objects are flagged as errors. This approach finds some dangling pointer references, but not when the memory has been reallocated and a valid object is sitting in its place. This approach also finds some out-of-bound array accesses, if they happen to land in the space inserted at the end of the objects.

Purify also finds memory leaks at the end of a program execution. It searches the contents of all the allocated objects for possible pointer values. Any object without a pointer to it is a leaked chunk of memory. Purify reports the amount of memory leaked and the locations of the leaked objects. We may compare Purify to a "conservative garbage collector," which will be discussed in Section 7.8.3.

and machine. One antidote is to have the compiler insert checks with every access, to make sure it is within bounds. The compiler's optimizer can discover and remove those checks that are not really necessary because the optimizer can deduce that the access must be within bounds.

#### Programming Conventions and Tools

We now present a few of the most popular conventions and tools that have been developed to help programmers cope with the complexity in managing memory:

- *Object ownership* is useful when an object's lifetime can be statically reasoned about. The idea is to associate an *owner* with each object at all times. The owner is a pointer to that object, presumably belonging to some function invocation. The owner (i.e., its function) is responsible for either deleting the object or for passing the object to another owner. It is possible to have other, nonowning pointers to the same object; these pointers can be overwritten any time, and no deletes should ever be applied through them. This convention eliminates memory leaks, as well as attempts to delete the same object twice. However, it does not help solve the dangling-pointer-reference problem, because it is possible to follow a nonowning pointer to an object that has been deleted.
- *Reference counting* is useful when an object's lifetime needs to be determined dynamically. The idea is to associate a count with each dynamically

allocated object. Whenever a reference to the object is created, we increment the reference count; whenever a reference is removed, we decrement the reference count. When the count goes to zero, the object can no longer be referenced and can therefore be deleted. This technique, however, does not catch useless, circular data structures, where a collection of objects cannot be accessed, but their reference counts are not zero, since they refer to each other. For an illustration of this problem, see Example 7.11. Reference counting does eradicate all dangling-pointer references, since there are no outstanding references to any deleted objects. Reference counting is expensive because it imposes an overhead on every operation that stores a pointer.

- *Region-based allocation* is useful for collections of objects whose lifetimes are tied to specific phases in a computation. When objects are created to be used only within some step of a computation, we can allocate all such objects in the same region. We then delete the entire region once that computation step completes. This *region-based allocation* technique has limited applicability. However, it is very efficient whenever it can be used; instead of deallocating objects one at a time, it deletes all objects in the region in a wholesale fashion.

#### 7.4.6 Exercises for Section 7.4

Exercise 7.4.1: Suppose the heap consists of seven chunks, starting at address 0. The sizes of the chunks, in order, are 80, 30, 60, 50, 70, 20, 40 bytes. When we place an object in a chunk, we put it at the high end if there is enough space remaining to form a smaller chunk (so that the smaller chunk can easily remain on the linked list of free space). However, we cannot tolerate chunks of fewer than 8 bytes, so if an object is almost as large as the selected chunk, we give it the entire chunk and place the object at the low end of the chunk. If we request space for objects of the following sizes: 32, 64, 48, 16, in that order, what does the free space list look like after satisfying the requests, if the method of selecting chunks is

- a) First fit.
- b) Best fit.

### 7.5 Introduction to Garbage Collection

Data that cannot be referenced is generally known as *garbage*. Many high-level programming languages remove the burden of manual memory management from the programmer by offering automatic garbage collection, which deallocates unreachable data. Garbage collection dates back to the initial implementation of Lisp in 1958. Other significant languages that offer garbage collection include Java, Perl, ML, Modula-3, Prolog, and Smalltalk.

In this section, we introduce many of the concepts of garbage collection. The notion of an object being "reachable" is perhaps intuitive, but we need to be precise; the exact rules are discussed in Section 7.5.2. We also discuss, in Section 7.5.3, a simple, but imperfect, method of automatic garbage collection: reference counting, which is based on the idea that once a program has lost all references to an object, it simply cannot and so will not reference the storage.

Section 7.6 covers trace-based collectors, which are algorithms that discover all the objects that are still useful, and then turn all the other chunks of the heap into free space.

### 7.5.1 Design Goals for Garbage Collectors

Garbage collection is the reclamation of chunks of storage holding objects that can no longer be accessed by a program. We need to assume that objects have a type that can be determined by the garbage collector at run time. From the type information, we can tell how large the object is and which components of the object contain references (pointers) to other objects. We also assume that references to objects are always to the address of the beginning of the object, never pointers to places within the object. Thus, all references to an object have the same value and can be identified easily.

A user program, which we shall refer to as the *mutator*, modifies the collection of objects in the heap. The mutator creates objects by acquiring space from the memory manager, and the mutator may introduce and drop references to existing objects. Objects become garbage when the mutator program cannot "reach" them, in the sense made precise in Section 7.5.2. The garbage collector finds these unreachable objects and reclaims their space by handing them to the memory manager, which keeps track of the free space.

#### A Basic Requirement: Type Safety

Not all languages are good candidates for automatic garbage collection. For a garbage collector to work, it must be able to tell whether any given data element or component of a data element is, or could be used as, a pointer to a chunk of allocated memory space. A language in which the type of any data component can be determined is said to be *type safe*. There are type-safe languages like ML, for which we can determine types at compile time. There are other type-safe languages, like Java, whose types cannot be determined at compile time, but can be determined at run time. The latter are called *dynamically typed* languages. If a language is neither statically nor dynamically type safe, then it is said to be *unsafe*.

Unsafe languages, which unfortunately include some of the most important languages such as C and C++, are bad candidates for automatic garbage collection. In unsafe languages, memory addresses can be manipulated arbitrarily: arbitrary arithmetic operations can be applied to pointers to create new pointers, and arbitrary integers can be cast as pointers. Thus a program

theoretically could refer to any location in memory at any time. Consequently, no memory location can be considered to be inaccessible, and no storage can ever be reclaimed safely.

In practice, most C and C++ programs do not generate pointers arbitrarily, and a theoretically unsound garbage collector that works well empirically has been developed and used. We shall discuss conservative garbage collection for C and C++ in Section 7.8.3.

### Performance Metrics

Garbage collection is often so expensive that, although it was invented decades ago and absolutely prevents memory leaks, it has yet to be adopted by many mainstream programming languages. Many different approaches have been proposed over the years, and there is not one clearly best garbage-collection algorithm. Before exploring the options, let us first enumerate the performance metrics that must be considered when designing a garbage collector.

- *Overall Execution Time.* Garbage collection can be very slow. It is important that it not significantly increase the total run time of an application. Since the garbage collector necessarily must touch a lot of data, its performance is determined greatly by how it leverages the memory subsystem.
- *Space Usage.* It is important that garbage collection avoid fragmentation and make the best use of the available memory.
- *Pause Time.* Simple garbage collectors are notorious for causing programs — the mutators — to pause suddenly for an extremely long time, as garbage collection kicks in without warning. Thus, besides minimizing the overall execution time, it is desirable that the maximum pause time be minimized. As an important special case, real-time applications require certain computations to be completed within a time limit. We must either suppress garbage collection while performing real-time tasks, or restrict maximum pause time. Thus, garbage collection is seldom used in real-time applications.
- *Program Locality.* We cannot evaluate the speed of a garbage collector solely by its running time. The garbage collector controls the placement of data and thus influences the data locality of the mutator program. It can improve a mutator's temporal locality by freeing up space and reusing it; it can improve the mutator's spatial locality by relocating data used together in the same cache or pages.

Some of these design goals conflict with one another, and tradeoffs must be made carefully by considering how programs typically behave. Also objects of different characteristics may favor different treatments, requiring a collector to use different techniques for different kinds of objects.



For example, the number of objects allocated is dominated by small objects, so allocation of small objects must not incur a large overhead. On the other hand, consider garbage collectors that relocate reachable objects. Relocation is expensive when dealing with large objects, but less so with small objects.

As another example, in general, the longer we wait to collect garbage in a trace-based collector, the larger the fraction of objects that can be collected. The reason is that objects often "die young," so if we wait a while, many of the newly allocated objects will become unreachable. Such a collector thus costs less on the average, per unreachable object collected. On the other hand, infrequent collection increases a program's memory usage, decreases its data locality, and increases the length of the pauses.

In contrast, a reference-counting collector, by introducing a constant overhead to many of the mutator's operations, can slow down the overall execution of a program significantly. On the other hand, reference counting does not create long pauses, and it is memory efficient, because it finds garbage as soon as it is produced (with the exception of certain cyclic structures discussed in Section 7.5.3).

Language design can also affect the characteristics of memory usage. Some languages encourage a programming style that generates a lot of garbage. For example, programs in functional or almost functional programming languages create more objects to avoid mutating existing objects. In Java, all objects, other than base types like integers and references, are allocated on the heap and not the stack, even if their lifetimes are confined to that of one function invocation. This design frees the programmer from worrying about the lifetimes of variables, at the expense of generating more garbage. Compiler optimizations have been developed to analyze the lifetimes of variables and allocate them on the stack whenever possible.

## 7.5.2 Reachability

We refer to all the data that can be accessed directly by a program, without having to dereference any pointer, as the *root set*. For example, in Java the root set of a program consists of all the static field members and all the variables on its stack. A program obviously can reach any member of its root set at any time. Recursively, any object with a reference that is stored in the field members or array elements of any reachable object is itself reachable.

Reachability becomes a bit more complex when the program has been optimized by the compiler. First, a compiler may keep reference variables in registers. These references must also be considered part of the root set. Second, even though in a type-safe language programmers do not get to manipulate memory addresses directly, a compiler often does so for the sake of speeding up the code. Thus, registers in compiled code may point to the middle of an object or an array, or they may contain a value to which an offset will be applied to compute a legal address. Here are some things an optimizing compiler can do to enable the garbage collector to find the correct root set:

- The compiler can restrict the invocation of garbage collection to only certain code points in the program, when no "hidden" references exist.
- The compiler can write out information that the garbage collector can use to recover all the references, such as specifying which registers contain references, or how to compute the base address of an object that is given an internal address.
- The compiler can assure that there is a reference to the base address of all reachable objects whenever the garbage collector may be invoked.

The set of reachable objects changes as a program executes. It grows as new objects get created and shrinks as objects become unreachable. It is important to remember that once an object becomes unreachable, it cannot become reachable again. There are four basic operations that a mutator performs to change the set of reachable objects:

- *Object Allocations.* These are performed by the memory manager, which returns a reference to each newly allocated chunk of memory. This operation adds members to the set of reachable objects.
- *Parameter Passing and Return Values.* References to objects are passed from the actual input parameter to the corresponding formal parameter, and from the returned result back to the callee. Objects pointed to by these references remain reachable.
- *Reference Assignments.* Assignments of the form  $u = v$ , where  $u$  and  $v$  are references, have two effects. First,  $u$  is now a reference to the object referred to by  $v$ . As long as  $u$  is reachable, the object it refers to is surely reachable. Second, the original reference in  $u$  is lost. If this reference is the last to some reachable object, then that object becomes unreachable. Any time an object becomes unreachable, all objects that are reachable only through references contained in that object also become unreachable.
- *Procedure Returns.* As a procedure exits, the frame holding its local variables is popped off the stack. If the frame holds the only reachable reference to any object, that object becomes unreachable. Again, if the now unreachable objects hold the only references to other objects, they too become unreachable, and so on.

In summary, new objects are introduced through object allocations. Parameter passing and assignments can propagate reachability; assignments and ends of procedures can terminate reachability. As an object becomes unreachable, it can cause more objects to become unreachable.

There are two basic ways to find unreachable objects. Either we catch the transitions as reachable objects turn unreachable, or we periodically locate all the reachable objects and then infer that all the other objects are unreachable. *Reference counting*, introduced in Section 7.4.5, is a well-known approximation

## Survival of Stack Objects

When a procedure is called, a local variable  $v$ , whose object is allocated on the stack, may have pointers to  $v$  placed in nonlocal variables. These pointers will continue to exist after the procedure returns, yet the space for  $v$  disappears, resulting in a dangling-reference situation. Should we ever allocate a local like  $v$  on the stack, as C does for example? The answer is that the semantics of many languages *requires* that local variables cease to exist when their procedure returns. Retaining a reference to such a variable is a programming error, and the compiler is not required to fix the bug in the program.

to the first approach. We maintain a count of the references to an object, as the mutator performs actions that may change the reachability set. When the count goes to zero, the object becomes unreachable. We discuss this approach in more detail in Section 7.5.3.

The second approach computes reachability by tracing all the references transitively. A *trace-based* garbage collector starts by labeling ("marking") all objects in the root set as "reachable," examines iteratively all the references in reachable objects to find more reachable objects, and labels them as such. This approach must trace all the references before it can determine any object to be unreachable. But once the reachable set is computed, it can find many unreachable objects all at once and locate a good deal of free storage at the same time. Because all the references must be analyzed at the same time, we have an option to relocate the reachable objects and thereby reduce fragmentation. There are many different trace-based algorithms, and we discuss the options in Sections 7.6 and 7.7.1.

### 7.5.3 Reference Counting Garbage Collectors

We now consider a simple, although imperfect, garbage collector, based on reference counting, which identifies garbage as an object changes from being reachable to unreachable; the object can be deleted when its count drops to zero. With a reference-counting garbage collector, every object must have a field for the reference count. Reference counts can be maintained as follows:

1. *Object Allocation.* The reference count of the new object is set to 1.
2. *Parameter Passing.* The reference count of each object passed into a procedure is incremented.
3. *Reference Assignments.* For statement  $u = v$ , where  $u$  and  $v$  are references, the reference count of the object referred to by  $v$  goes up by one, and the count for the old object referred to by  $u$  goes down by one.

4. *Procedure Returns.* As a procedure exits, all the references held by the local variables of that procedure activation record must also be decremented. If several local variables hold references to the same object, that object's count must be decremented once for each such reference.
5. *Transitive Loss of Reachability.* Whenever the reference count of an object becomes zero, we must also decrement the count of each object pointed to by a reference within the object.

Reference counting has two main disadvantages: it cannot collect unreachable, cyclic data structures, and it is expensive. Cyclic data structures are quite plausible; data structures often point back to their parent nodes, or point to each other as cross references.

Example 7.11: Figure 7.18 shows three objects with references among them, but no references from anywhere else. If none of these objects is part of the root set, then they are all garbage, but their reference counts are each greater than 0. Such a situation is tantamount to a memory leak if we use reference counting for garbage collection, since then this garbage and any structures like it are never deallocated. •

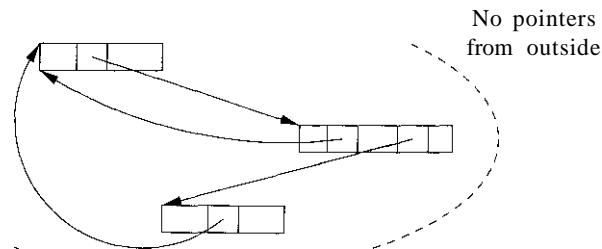

Figure 7.18: An unreachable, cyclic data structure

The overhead of reference counting is high because additional operations are introduced with each reference assignment, and at procedure entries and exits. This overhead is proportional to the amount of computation in the program, and not just to the number of objects in the system. Of particular concern are the updates made to references in the root set of a program. The concept of *deferred reference counting* has been proposed as a means to eliminate the overhead associated with updating the reference counts due to local stack accesses. That is, reference counts do not include references from the root set of the program. An object is not considered to be garbage until the entire root set is scanned and no references to the object are found.

The advantage of reference counting, on the other hand, is that garbage collection is performed in an *incremental* fashion. Even though the total overhead can be large, the operations are spread throughout the mutator's computation.

Although removing one reference may render a large number of objects unreachable, the operation of recursively modifying reference counts can easily be deferred and performed piecemeal across time. Thus, reference counting is particularly attractive algorithm when timing deadlines must be met, as well as for interactive applications where long, sudden pauses are unacceptable. Another advantage is that garbage is collected immediately, keeping space usage low.

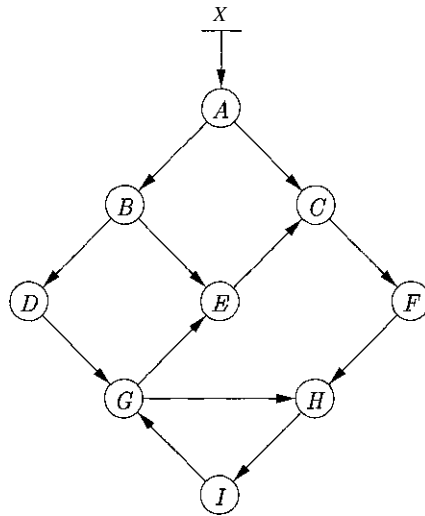

Figure 7.19: A network of objects

### 7.5.4 Exercises for Section 7.5

Exercise 7.5.1: What happens to the reference counts of the objects in Fig. 7.19 if:

- The pointer from  $A$  to  $B$  is deleted.
- The pointer from  $X$  to  $A$  is deleted.
- The node  $C$  is deleted.

Exercise 7.5.2: What happens to reference counts when the pointer from  $A$  to  $D$  in Fig. 7.20 is deleted?

## 7.6 Introduction to Trace-Based Collection

Instead of collecting garbage as it is created, trace-based collectors run periodically to find unreachable objects and reclaim their space. Typically, we run the

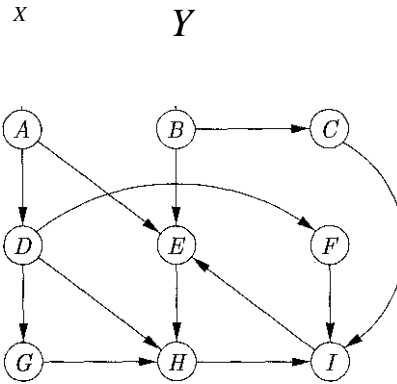

Figure 7.20: Another network of objects

trace-based collector whenever the free space is exhausted or its amount drops below some threshold.

We begin this section by introducing the simplest "mark-and-sweep" garbage collection algorithm. We then describe the variety of trace-based algorithms in terms of four states that chunks of memory can be put in. This section also contains a number of improvements on the basic algorithm, including those in which object relocation is a part of the garbage-collection function.

### 7.6.1 A Basic Mark-and-Sweep Collector

*Mark-and-sweep* garbage-collection algorithms are straightforward, stop-the-world algorithms that find all the unreachable objects, and put them on the list of free space. Algorithm 7.12 visits and "marks" all the reachable objects in the first tracing step and then "sweeps" the entire heap to free up unreachable objects. Algorithm 7.14, which we consider after introducing a general framework for trace-based algorithms, is an optimization of Algorithm 7.12. By using an additional list to hold all the allocated objects, it visits the reachable objects only once.

Algorithm 7.12: Mark-and-sweep garbage collection.

**INPUT:** A root set of objects, a heap, and a *free list*, called *Free*, with all the unallocated chunks of the heap. As in Section 7.4.4, all chunks of space are marked with boundary tags to indicate their free/used status and size.

**OUTPUT:** A modified *Free* list after all the garbage has been removed.

**METHOD:** The algorithm, shown in Fig. 7.21, uses several simple data structures. List *Free* holds objects known to be free. A list called *Unscanned*, holds objects that we have determined are reached, but whose successors we have not yet considered. That is, we have not scanned these objects to see what other

```

/* marking phase */
1) set the reached-bit to 1 and add to list Unscanned each object
   referenced by the root set;
2) while (Unscanned ^ 0) {
3)   remove some object o from Unscanned;
4)   for (each object d referenced in o) {
5)     if (o is unreachable; i.e., its reached-bit is 0) {
6)       set the reached-bit of d to 1;
7)       put d in Unscanned;
           }
   }
}
/* sweeping phase */
8) Free = 0;
9) for (each chunk of memory o in the heap) {
10)   if (o is unreachable, i.e., its reached-bit is 0) add o to Free;
11)   else set the reached-bit of o to 0;
}

```

Figure 7.21: A Mark-and-Sweep Garbage Collector

objects can be reached through them. The *Unscanned* list is empty initially. Additionally, each object includes a bit to indicate whether it has been reached (the *reached-bit*). Before the algorithm begins, all allocated objects have the reached-bit set to 0.

In line (1) of Fig. 7.21, we initialize the *Unscanned* list by placing there all the objects referenced by the root set. The reached-bit for these objects is also set to 1. Lines (2) through (7) are a loop, in which we, in turn, examine each object *o* that is ever placed on the *Unscanned* list.

The for-loop of lines (4) through (7) implements the scanning of object *o*. We examine each object *d* for which we find a reference within *o*. If *d* has already been reached (its reached-bit is 1), then there is no need to do anything about *d*; it either has been scanned previously, or it is on the *Unscanned* list to be scanned later. However, if *d* was not reached already, then we need to set its reached-bit to 1 in line (6) and add *d* to the *Unscanned* list in line (7). Figure 7.22 illustrates this process. It shows an *Unscanned* list with four objects. The first object on this list, corresponding to object *o* in the discussion above, is in the process of being scanned. The dashed lines correspond to the three kinds of objects that might be reached from *o*:

1. A previously scanned object that need not be scanned again.
2. An object currently on the *Unscanned* list.
3. An item that is reachable, but was previously thought to be unreachable.

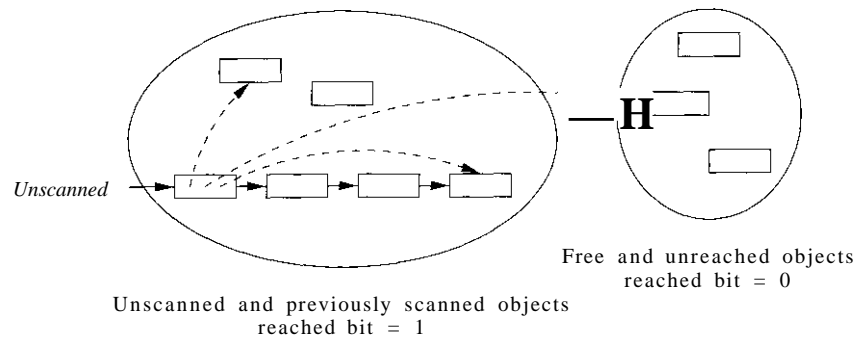

Figure 7.22: The relationships among objects during the marking phase of a mark-and-sweep garbage collector

Lines (8) through (11), the sweeping phase, reclaim the space of all the objects that remain unreachable at the end of the marking phase. Note that these will include any objects that were on the *Free* list originally. Because the set of unreachable objects cannot be enumerated directly, the algorithm sweeps through the entire heap. Line (10) puts free and unreachable objects on the *Free* list, one at a time. Line (11) handles the reachable objects. We set their reached-bit to 0, in order to maintain the proper preconditions for the next execution of the garbage-collection algorithm. •

## 7.6.2 Basic Abstraction

All trace-based algorithms compute the set of reachable objects and then take the complement of this set. Memory is therefore recycled as follows:

- a) The program or mutator runs and makes allocation requests.
- b) The garbage collector discovers reachability by tracing.
- c) The garbage collector reclaims the storage for unreachable objects.

This cycle is illustrated in Fig. 7.23 in terms of four states for chunks of memory: *Free*, *Unreached*, *Unscanned*, and *Scanned*. The state of a chunk might be stored in the chunk itself, or it might be implicit in the data structures used by the garbage-collection algorithm.

While trace-based algorithms may differ in their implementation, they can all be described in terms of the following states:

1. *Free*. A chunk is in the *Free* state if it is ready to be allocated. Thus, a *Free* chunk must not hold a reachable object.
2. *Unreached*. Chunks are presumed unreachable, unless proven reachable by tracing. A chunk is in the *Unreached* state at any point during garbage



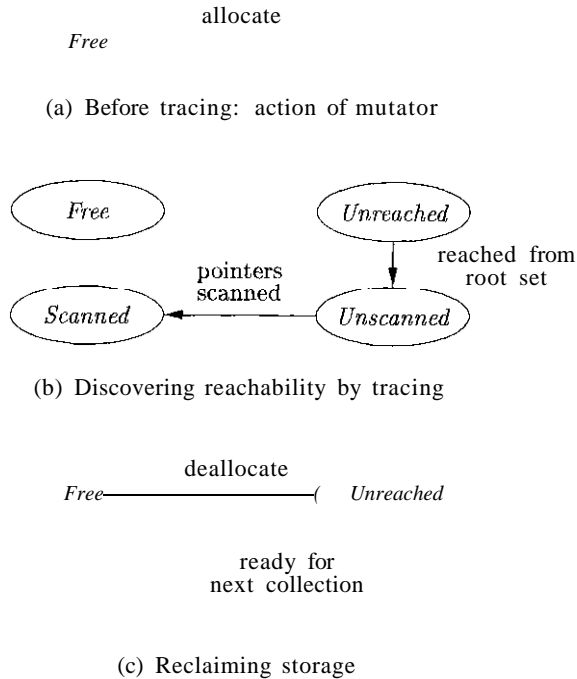

Figure 7.23: States of memory in a garbage collection cycle

collection if its reachability has not yet been established. Whenever a chunk is allocated by the memory manager, its state is set to *Unreached* as illustrated in Fig. 7.23(a). Also, after a round of garbage collection, the state of a reachable object is reset to *Unreached* to get ready for the next round; see the transition from *Scanned* to *Unreached*, which is shown dashed to emphasize that it prepares for the next round.

3. *Unscanned*. Chunks that are known to be reachable are either in state *Unscanned* or state *Scanned*. A chunk is in the *Unscanned* state if it is known to be reachable, but its pointers have not yet been scanned. The transition to *Unscanned* from *Unreached* occurs when we discover that a chunk is reachable; see Fig. 7.23(b).
4. *Scanned*. Every *Unscanned* object will eventually be scanned and transition to the *Scanned* state. To *scan* an object, we examine each of the pointers within it and follow those pointers to the objects to which they refer. If a reference is to an *Unreached* object, then that object is put in the *Unscanned* state. When the scan of an object is completed, that object is placed in the *Scanned* state; see the lower transition in Fig. 7.23(b). A *Scanned* object can only contain references to other *Scanned* or *Unscanned* objects, and never to *Unreached* objects.

When no objects are left in the *Unscanned* state, the computation of reachability is complete. Objects left in the *Unreached* state at the end are truly unreachable. The garbage collector reclaims the space they occupy and places the chunks in the *Free* state, as illustrated by the solid transition in Fig. 7.23(c). To get ready for the next cycle of garbage collection, objects in the *Scanned* state are returned to the *Unreached* state; see the dashed transition in Fig. 7.23(c). Again, remember that these objects really are reachable right now. The *Unreachable* state is appropriate because we shall want to start all objects out in this state when garbage collection next begins, by which time any of the currently reachable objects may indeed have been rendered unreachable.

**Example 7.13:** Let us see how the data structures of Algorithm 7.12 relate to the four states introduced above. Using the reached-bit and membership on lists *Free* and *Unscanned*, we can distinguish among all four states. The table of Fig. 7.24 summarizes the characterization of the four states in terms of the data structure for Algorithm 7.12. •

STATE	ON <i>Free</i>	ON <i>Unscanned</i>	REACHED-BIT
<i>Free</i>	Yes	No	0
<i>Unreached</i>	No	No	0
<i>Unscanned</i>	No	Yes	1
<i>Scanned</i>	No	No	1

Figure 7.24: Representation of states in Algorithm 7.12

### 7.6.3 Optimizing Mark-and-Sweep

The final step in the basic mark-and-sweep algorithm is expensive because there is no easy way to find only the unreachable objects without examining the entire heap. An improved algorithm, due to Baker, keeps a list of all allocated objects. To find the set of unreachable objects, which we must return to free space, we take the set difference of the allocated objects and the reached objects.

**Algorithm 7.14:** Baker's mark-and-sweep collector.

**INPUT:** A root set of objects, a heap, a free list *Free*, and a list of allocated objects, which we refer to as *Unreached*.

**OUTPUT:** Modified lists *Free* and *Unreached*, which holds allocated objects.

**METHOD:** In this algorithm, shown in Fig. 7.25, the data structure for garbage collection is four lists named *Free*, *Unreached*, *Unscanned*, and *Scanned*, each of which holds all the objects in the state of the same name. These lists may be implemented by embedded, doubly linked lists, as was discussed in Section 7.4.4. A reached-bit in objects is not used, but we assume that each object

contains bits telling which of the four states it is in. Initially, *Free* is the free list maintained by the memory manager, and all allocated objects are on the *Unreached* list (also maintained by the memory manager as it allocates chunks to objects).

```

1) Scanned = 0;
2) Unscanned — set of objects referenced in the root set;
3) while (Unscanned ≠ 0) {
4)     move object o from Unscanned to Scanned;
5)     for (each object o' referenced in o) {
6)         if (o' is in Unreached)
7)             move d from Unreached to Unscanned;
           }
           }
8) Free = Free ∪ Unreached;
9) Unreached = Scanned;

```

Figure 7.25: Baker's mark-and-sweep algorithm

Lines (1) and (2) initialize *Scanned* to be the empty list, and *Unscanned* to have only the objects reached from the root set. Note that these objects were presumably on the list *Unreached* and must be removed from there. Lines (3) through (7) are a straightforward implementation of the basic marking algorithm, using these lists. That is, the for-loop of lines (5) through (7) examines the references in one unscanned object *o*, and if any of those references *o'* have not yet been reached, line (7) changes *o'* to the *Unscanned* state.

At the end, line (8) takes those objects that are still on the *Unreached* list and deallocates their chunks, by moving them to the *Free* list. Then, line (9) takes all the objects in state *Scanned*, which are the reachable objects, and reinitializes the *Unreached* list to be exactly those objects. Presumably, as the memory manager creates new objects, those too will be added to the *Unreached* list and removed from the *Free* list. •

In both algorithms of this section, we have assumed that chunks returned to the free list remain as they were before deallocation. However, as discussed in Section 7.4.4, it is often advantageous to combine adjacent free chunks into larger chunks. If we wish to do so, then every time we return a chunk to the free list, either at line (10) of Fig. 7.21 or line (8) of Fig. 7.25, we examine the chunks to its left and right, and merge if one is free.

## 7.6.4 Mark-and-Compact Garbage Collectors

*Relocating* collectors move reachable objects around in the heap to eliminate memory fragmentation. It is common that the space occupied by reachable objects is much smaller than the freed space. Thus, after identifying all the holes,

instead of freeing them individually, one attractive alternative is to relocate all the reachable objects into one end of the heap, leaving the entire rest of the heap as one free chunk. After all, the garbage collector has already analyzed every reference within the reachable objects, so updating them to point to the new locations does not require much more work. These, plus the references in the root set, are all the references we need to change.

Having all the reachable objects in contiguous locations reduces fragmentation of the memory space, making it easier to house large objects. Also, by making the data occupy fewer cache lines and pages, relocation improves a program's temporal and spatial locality, since new objects created at about the same time are allocated nearby chunks. Objects in nearby chunks can benefit from prefetching if they are used together. Further, the data structure for maintaining free space is simplified; instead of a free list, all we need is a pointer *free* to the beginning of the one free block.

Relocating collectors vary in whether they relocate in place or reserve space ahead of time for the relocation:

- A *mark-and-compact collector*, described in this section, compacts objects in place. Relocating in place reduces memory usage.
- The more efficient and popular *copying collector* in Section 7.6.5 moves objects from one region of memory to another. Reserving extra space for relocation allows reachable objects to be moved as they are discovered.

The mark-and-compact collector in Algorithm 7.15 has three phases:

1. First is a marking phase, similar to that of the mark-and-sweep algorithms described previously.
2. Second, the algorithm scans the allocated section of the heap and computes a new address for each of the reachable objects. New addresses are assigned from the low end of the heap, so there are no holes between reachable objects. The new address for each object is recorded in a structure called *NewLocation*.
3. Finally, the algorithm copies objects to their new locations, updating all references in the objects to point to the corresponding new locations. The needed addresses are found in *NewLocation*.

Algorithm 7.15: A mark-and-compact garbage collector.

**INPUT:** A root set of objects, a heap, and *free*, a pointer marking the start of free space.

**OUTPUT:** The new value of pointer *free*.

**METHOD:** The algorithm is in Fig. 7.26; it uses the following data structures:

1. An *Unscanned* list, as in Algorithm 7.12.

2. Reached bits in all objects, also as in Algorithm 7.12. To keep our description simple, we refer to objects as "reached" or "unreached," when we mean that their reached-bit is 1 or 0, respectively. Initially, all objects are unreached.
3. The pointer *free*, which marks the beginning of unallocated space in the heap.
4. The table *NewLocation*. This structure could be a hash table, search tree, or another structure that implements the two operations:
  - (a) Set *NewLocation(o)* to a new address for object *o*.
  - (b) Given object *o*, get the value of *NewLocation(o)*.

We shall not concern ourselves with the exact structure used, although you may assume that *NewLocation* is a hash table, and therefore, the "set" and "get" operations are each performed in average constant time, independent of how many objects are in the heap.

The first, or marking, phase of lines (1) through (7) is essentially the same as the first phase of Algorithm 7.12. The second phase, lines (8) through (12), visits each chunk in the allocated part of the heap, from the left, or low end. As a result, chunks are assigned new addresses that increase in the same order as their old addresses. This ordering is important, since when we relocate objects, we can do so in a way that assures we only move objects left, into space that was formerly occupied by objects we have moved already.

Line (8) starts the *free* pointer at the low end of the heap. In this phase, we use *free* to indicate the first available new address. We create a new address only for those objects *o* that are marked as reached. Object *o* is given the next available address at line (10), and at line (11) we increment *free* by the amount of storage that object *o* requires, so *free* again points to the beginning of free space.

In the final phase, lines (13) through (17), we again visit the reached objects, in the same from-the-left order as in the second phase. Lines (15) and (16) replace all internal pointers of a reached object *o* by their proper new values, using the *NewLocation* table to determine the replacement. Then, line (17) moves the object *o*, with the revised internal references, to its new location. Finally, lines (18) and (19) retarget pointers in the elements of the root set that are not themselves heap objects, e.g., statically allocated or stack-allocated objects. Figure 7.27 suggests how the reachable objects (those that are not shaded) are moved down the heap, while the internal pointers are changed to point to the new locations of the reached objects. •

### 7.6.5 Copying collectors

A copying collector reserves, ahead of time, space to which the objects can move, thus breaking the dependency between tracing and finding free space.

```

/* mark */
1) Unscanned — set of objects referenced by the root set;
2) while (Unscanned ^ 0) {
3)     remove object o from Unscanned;
4)     for (each object d referenced in 6) {
5)         if (d is unreachable) {
6)             mark d as reached;
7)             put d on list Unscanned;
            }
        }
    }
/* compute new locations */
8) free = starting location of heap storage;
9) for (each chunk of memory o in the heap, from the low end) {
10)    if (o is reached {
11)        NewLocation(o) = free;
12)        free = free + sizeof(d);
    }
}
/* retarget references and move reached objects */
13) for (each chunk of memory o in the heap, from the low end) {
14)    if (o is reached) {
15)        for (each reference o.r in 6)
16)            o.r = NewLocation(o.r);
17)        copy o to NewLocation(o);
    }
}
18) for (each reference r in the root set)
19)    r = NewLocation(r);

```

Figure 7.26: A Mark-and-Compact Collector

The memory space is partitioned into two *semispaces*, *A* and *B*. The mutator allocates memory in one semispace, say *A*, until it fills up, at which point the mutator is stopped and the garbage collector copies the reachable objects to the other space, say *B*. When garbage collection completes, the roles of the semispaces are reversed. The mutator is allowed to resume and allocate objects in space *B*, and the next round of garbage collection moves reachable objects to space *A*. The following algorithm is due to C. J. Cheney.

**Algorithm 7.16:** Cheney's copying collector.

**INPUT:** A root set of objects, and a heap consisting of the *From* semispace, containing allocated objects, and the *To* semispace, all of which is free.

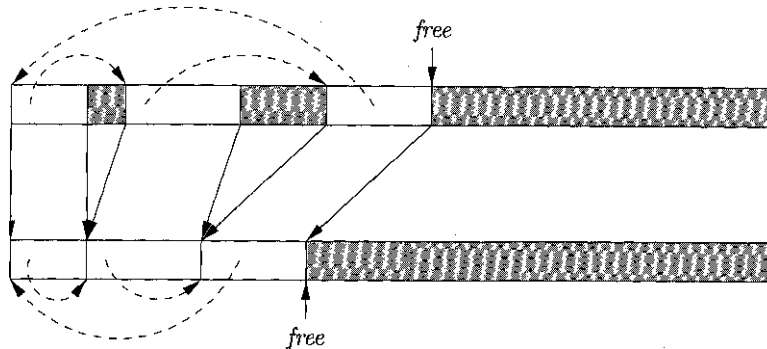

Figure 7.27: Moving reached objects to the front of the heap, while preserving internal pointers

**OUTPUT:** At the end, the *To* semispace holds the allocated objects. A *free* pointer indicates the start of free space remaining in the *To* semispace. The *From* semispace is completely free.

**METHOD:** The algorithm is shown in Fig. 7.28. Cheney's algorithm finds reachable objects in the *From* semispace and copies them, as soon as they are reached, to the *To* semispace. This placement groups related objects together and may improve spatial locality.

Before examining the algorithm itself, which is the function *CopyingCollector m*. Fig. 7.28, consider the auxiliary function *LookupNewLocation* in lines (11) through (16). This function takes an object *o* and finds a new location for it in the *To* space if *o* has no location there yet. All new locations are recorded in a structure *NewLocation*, and a value of NULL indicates *o* has no assigned location.<sup>5</sup> As in Algorithm 7.15, the exact form of structure *NewLocation* may vary, but it is fine to assume that it is a hash table.

If we find at line (12) that *o* has no location, then it is assigned the beginning of the free space within the *To* semispace, at line (13). Line (14) increments the *free* pointer by the amount of space taken by *o*, and at line (15) we copy *o* from the *From* space to the *To* space. Thus, the movement of objects from one semispace to the other occurs as a side effect, the first time we look up the new location for the object. Regardless of whether the location of *o* was or was not previously established, line (16) returns the location of *o* in the *To* space.

Now, we can consider the algorithm itself. Line (2) establishes that none of the objects in the *From* space have new addresses yet. At line (3), we initialize two pointers, *unscanned* and *free*, to the beginning of the *To* semispace. Pointer *free* will always indicate the beginning of free space within the *To* space. As we add objects to the *To* space, those with addresses below *unscanned* will be in the *Scanned* state, while those between *unscanned* and *free* are in the *Unscanned*

<sup>5</sup>In a typical data structure, such as a hash table, if *o* is not assigned a location, then there simply would be no mention of it in the structure.

```

1) CopyingCollector () {
2)     for (all objects o in From space) NewLocation(o) =NULL;
3)     unscanned — free = starting address of To space;
4)     for (each reference r in the root set)
5)         replace r with LookupNewLocation(r);
6)     while (unscanned ^ free) {
7)         o — object at location unscanned]
8)         for (each reference o.r within o)
9)             o.r = LookupNewLocation(o.r);
10)        unscanned — unscanned + sizeof(o);
        }
    }

    /* Look up the new location for object if it has been moved. */
    /* Place object in Unscanned state otherwise. */
11) LookupNewLocation(o) {
12)     if (NewLocation(o) = NULL) {
13)         NewLocation(o) — free;
14)         free = free + sizeof(o);
15)         copy o to NewLocation(o);
        }
16)     return NewLocation(o);
    }

```

Figure 7.28: A Copying Garbage Collector

state. Thus, *free* always leads *unscanned*, and when the latter catches up to the former, there are no more *Unscanned* objects, and we are done with the garbage collection. Notice that we do our work within the *To* space, although all references within objects examined at line (8) lead us back to the *From* space.

Lines (4) and (5) handle the objects reachable from the root set. Note that as a side effect, some of the calls to *LookupNewLocation* at line (5) will increase *free*, as chunks for these objects are allocated within *To*. Thus, the loop of lines (6) through (10) will be entered the first time it is reached, unless there are no objects referenced by the root set (in which case the entire heap is garbage). This loop then scans each of the objects that has been added to *To* and is in the *Unscanned* state. Line (7) takes the next unscanned object, *o*. Then, at lines (8) and (9), each reference within *o* is translated from its value in the *From* semispace to its value in the *To* semispace. Notice that, as a side effect, if a reference within *o* is to an object we have not reached previously, then the call to *LookupNewLocation* at line (9) creates space for that object in the *To* space and moves the object there. Finally, line (10) increments *unscanned* to point to the next object, just beyond *o* in the *To* space. •



### 7.6.6 Comparing Costs

Cheney's algorithm has the advantage that it does not touch any of the unreachable objects. On the other hand, a copying garbage collector must move the contents of all the reachable objects. This process is especially expensive for large objects and for long-lived objects that survive multiple rounds of garbage collection. We can summarize the running time of each of the four algorithms described in this section, as follows. Each estimate ignores the cost of processing the root set.

- *Basic Mark-and-Sweep* (Algorithm 7.12): Proportional to the number of chunks in the heap.
- *Baker's Mark-and-Sweep* (Algorithm 7.14): Proportional to the number of reached objects.
- » *Basic Mark-and-Compact* (Algorithm 7.15): Proportional to the number of chunks in the heap plus the total size of the reached objects.
- *Cheney's Copying Collector* (Algorithm 7.16): Proportional to the total size of the reached objects.

### 7.6.7 Exercises for Section 7.6

**Exercise 7.6.1:** Show the steps of a mark-and-sweep garbage collector on

- a) Fig. 7.19 with the pointer  $A \rightarrow B$  deleted.
- b) Fig. 7.19 with the pointer  $A \rightarrow C$  deleted.
- c) Fig. 7.20 with the pointer  $A \rightarrow D$  deleted.
- d) Fig. 7.20 with the object  $B$  deleted.

**Exercise 7.6.2:** The Baker mark-and-sweep algorithm moves objects among four lists: *Free*, *Unreached*, *Unscanned*, and *Scanned*. For each of the object networks of Exercise 7.6.1, indicate for each object the sequence of lists on which it finds itself from just before garbage collection begins until just after it finishes.

**Exercise 7.6.3:** Suppose we perform a mark-and-compact garbage collection on each of the networks of Exercise 7.6.1. Also, suppose that

- i. Each object has size 100 bytes, and
- ii. Initially, the nine objects in the heap are arranged in alphabetical order, starting at byte 0 of the heap.

What is the address of each object after garbage collection?

**Exercise 7.6.4:** Suppose we execute Cheney's copying garbage collection algorithm on each of the networks of Exercise 7.6.1. Also, suppose that

- i.* Each object has size 100 bytes,
- ii.* The unscanned list is managed as a queue, and when an object has more than one pointer, the reached objects are added to the queue in alphabetical order, and
- Hi.* The *From* semispace starts at location 0, and the *To* semispace starts at location 10,000.

What is the value of  $NewLocation(o)$  for each object  $o$  that remains after garbage collection?

## 7.7 Short-Pause Garbage Collection

Simple trace-based collectors do stop-the-world-style garbage collection, which may introduce long pauses into the execution of user programs. We can reduce the length of the pauses by performing garbage collection one part at a time. We can divide the work in time, by interleaving garbage collection with the mutation, or we can divide the work in space by collecting a subset of the garbage at a time. The former is known as *incremental collection* and the latter is known as *partial collection*.

An incremental collector breaks up the reachability analysis into smaller units, allowing the mutator to run between these execution units. The reachable set changes as the mutator executes, so incremental collection is complex. As we shall see in Section 7.7.1, finding a slightly conservative answer can make tracing more efficient.

The best known of partial-collection algorithms is *generational garbage collection* [ it partitions objects according to how long they have been allocated and collects the newly created objects more often because they tend to have a shorter lifetime. An alternative algorithm, the *train algorithm*, also collects a subset of garbage at a time, and is best applied to more mature objects. These two algorithms can be used together to create a partial collector that handles younger and older objects differently. We discuss the basic algorithm behind partial collection in Section 7.7.3, and then describe in more detail how the generational and train algorithms work.

Ideas from both incremental and partial collection can be adapted to create an algorithm that collects objects in parallel on a multiprocessor; see Section 7.8.1.

### 7.7.1 Incremental Garbage Collection

Incremental collectors are conservative. While a garbage collector must not collect objects that are not garbage, it does not have to collect all the garbage

in each round. We refer to the garbage left behind after collection as *floating garbage*. Of course it is desirable to minimize floating garbage. In particular, an incremental collector should not leave behind any garbage that was not reachable at the beginning of a collection cycle. If we can be sure of such a collection guarantee, then any garbage not collected in one round will be collected in the next, and no memory is leaked because of this approach to garbage collection.

In other words, incremental collectors play it safe by overestimating the set of reachable objects. They first process the program's root set atomically, without interference from the mutator. After finding the initial set of unscanned objects, the mutator's actions are interleaved with the tracing step. During this period, any of the mutator's actions that may change reachability are recorded succinctly, in a side table, so that the collector can make the necessary adjustments when it resumes execution. If space is exhausted before tracing completes, the collector completes the tracing process, without allowing the mutator to execute. In any event, when tracing is done, space is reclaimed atomically.

### Precision of Incremental Collection

Once an object becomes unreachable, it is not possible for the object to become reachable again. Thus, as garbage collection and mutation proceed, the set of reachable objects can only

1. Grow due to new objects allocated after garbage collection starts, and
2. Shrink by losing references to allocated objects.

Let the set of reachable objects at the beginning of garbage collection be  $R$ ; let  $New$  be the set of allocated objects during garbage collection, and let  $Lost$  be the set of objects that have become unreachable due to lost references since tracing began. The set of objects reachable when tracing completes is

$$(R \cup New) - Lost.$$

It is expensive to reestablish an object's reachability every time a mutator loses a reference to the object, so incremental collectors do not attempt to collect all the garbage at the end of tracing. Any garbage left behind — floating garbage — should be a subset of the  $Lost$  objects. Expressed formally, the set  $S$  of objects found by tracing must satisfy

$$(R \cup New) - Lost \supseteq S \supseteq (R \cup New)$$

### Simple Incremental Tracing

We first describe a straightforward tracing algorithm that finds the upper bound  $R \cup New$ . The behavior of the mutator is modified during the tracing as follows:

- All references that existed before garbage collection are preserved; that is, before the mutator overwrites a reference, its old value is remembered and treated like an additional unscanned object containing just that reference.
- All objects created are considered reachable immediately and are placed in the *Unscanned* state.

This scheme is conservative but correct, because it finds  $R$ , the set of all the objects reachable before garbage collection, plus *New*, the set of all the newly allocated objects. However, the cost is high, because the algorithm intercepts all write operations and remembers all the overwritten references. Some of this work is unnecessary because it may involve objects that are unreachable at the end of garbage collection. We could avoid some of this work and also improve the algorithm's precision if we could detect when the overwritten references point to objects that are unreachable when this round of garbage collection ends. The next algorithm goes fairly far in these two directions.

### 7.7.2 Incremental Reachability Analysis

If we interleave the mutator with a basic tracing algorithm, such as Algorithm 7.12, then some reachable objects may be misclassified as unreachable. The problem is that the actions of the mutator can violate a key invariant of the algorithm; namely, a *Scanned* object can only contain references to other *Scanned* or *Unscanned* objects, never to *Unreached* objects. Consider the following scenario:

1. The garbage collector finds object  $o_1$  reachable and scans the pointers within  $o_1$ , thereby putting  $o_1$  in the *Scanned* state.
2. The mutator stores a reference to an *Unreached* (but reachable) object  $o$  into the *Scanned* object  $o_1$ . It does so by copying a reference to  $o$  from an object  $o_2$  that is currently in the *Unreached* or *Unscanned* state.
3. The mutator loses the reference to  $o$  in object  $o_2$ . It may have overwritten  $o_2$ 's reference to  $o$  before the reference is scanned, or  $o_2$  may have become unreachable and never have reached the *Unscanned* state to have its references scanned.

Now,  $o$  is reachable through object  $o_1$ , but the garbage collector may have seen neither the reference to  $o$  in  $o_1$  nor the reference to  $o$  in  $o_2$ .

The key to a more precise, yet correct, incremental trace is that we must note all copies of references to currently unreached objects from an object that has not been scanned to one that has. To intercept problematic transfers of references, the algorithm can modify the mutator's action during tracing in any of the following ways:

- *Write Barriers.* Intercept writes of references into a *Scanned* object  $o$ , when the reference is to an *Unreached* object  $o$ . In this case, classify  $o$  as reachable and place it in the *Unscanned* set. Alternatively, place the written object  $o$  back in the *Unscanned* set so we can rescan it.
- *Read Barriers.* Intercept the reads of references in *Unreached* or *Unscanned* objects. Whenever the mutator reads a reference to an object  $o$  from an object in either the *Unreached* or *Unscanned* state, classify  $o$  as reachable and place it in the *Unscanned* set.
- *Transfer Barriers.* Intercept the loss of the original reference in an *Unreached* or *Unscanned* object. Whenever the mutator overwrites a reference in an *Unreached* or *Unscanned* object, save the reference being overwritten, classify it as reachable, and place the reference itself in the *Unscanned* set.

None of the options above finds the smallest set of reachable objects. If the tracing process determines an object to be reachable, it stays reachable even though all references to it are overwritten before tracing completes. That is, the set of reachable objects found is between  $(R \cup New) - Lost$  and  $(R \cup New)$ .

Write barriers are the most efficient of the options outlined above. Read barriers are more expensive because typically there are many more reads than there are writes. Transfer barriers are not competitive; because many objects "die young," this approach would retain many unreachable objects.

### Implementing Write Barriers

We can implement write barriers in two ways. The first approach is to remember, during a mutation phase, all new references written into the *Scanned* objects. We can place all these references in a list; the size of the list is proportional to the number of write operations to *Scanned* objects, unless duplicates are removed from the list. Note that references on the list may later be overwritten themselves and potentially could be ignored.

The second, more efficient approach is to remember the locations where the writes occur. We may remember them as a list of locations written, possibly with duplicates eliminated. Note it is not important that we pinpoint the exact locations written, as long as all the locations that have been written are rescanned. Thus, there are several techniques that allow us to remember less detail about exactly where the rewritten locations are.

- Instead of remembering the exact address or the object and field that is written, we can remember just the objects that hold the written fields.
- We can divide the address space into fixed-size blocks, known as *cards*, and use a bit array to remember the cards that have been written into.

- We can choose to remember the pages that contain the written locations. We can simply protect the pages containing *Scanned* objects. Then, any writes into *Scanned* objects will be detected without executing any explicit instructions, because they will cause a protection violation, and the operating system will raise a program exception.

In general, by coarsening the granularity at which we remember the written locations, less storage is needed, at the expense of increasing the amount of rescanning performed. In the first scheme, all references in the modified objects will have to be rescanned, regardless of which reference was actually modified. In the last two schemes, all reachable objects in the modified cards or modified pages need to be rescanned at the end of the tracing process.

### Combining Incremental and Copying Techniques

The above methods are sufficient for mark-and-sweep garbage collection. Copying collection is slightly more complicated, because of its interaction with the mutator. Objects in the *Scanned* or *Unscanned* states have two addresses, one in the *From* semispace and one in the *To* semispace. As in Algorithm 7.16, we must keep a mapping from the old address of an object to its relocated address.

There are two choices for how we update the references. First, we can have the mutator make all the changes in the *From* space, and only at the end of garbage collection do we update all the pointers and copy all the contents over to the *To* space. Second, we can instead make changes to the representation in the *To* space. Whenever the mutator dereferences a pointer to the *From* space, the pointer is translated to a new location in the *To* space if one exists. All the pointers need to be translated to point to the *To* space in the end.

### 7.7.3 Partial-Collection Basics

The fundamental fact is that objects typically "die young." It has been found that usually between 80% and 98% of all newly allocated objects die within a few million instructions, or before another megabyte has been allocated. That is, objects often become unreachable before any garbage collection is invoked. Thus, it is quite cost effective to garbage collect new objects frequently.

Yet, objects that survive a collection once are likely to survive many more collections. With the garbage collectors described so far, the same mature objects will be found to be reachable over and over again and, in the case of copying collectors, copied over and over again, in every round of garbage collection. Generational garbage collection works most frequently on the area of the heap that contains the youngest objects, so it tends to collect a lot of garbage for relatively little work. The train algorithm, on the other hand, does not spend a large proportion of time on young objects, but it does limit the pauses due to garbage collection. Thus, a good combination of strategies is to use generational collection for young objects, and once an object becomes

sufficiently mature, to "promote" it to a separate heap that is managed by the train algorithm.

We refer to the set of objects to be collected on one round of partial collection as the *target* set and the rest of the objects as the *stable* set. Ideally, a partial collector should reclaim all objects in the target set that are unreachable from the program's root set. However, doing so would require tracing all objects, which is what we try to avoid in the first place. Instead, partial collectors conservatively reclaim only those objects that cannot be reached through either the root set of the program or the stable set. Since some objects in the stable set may themselves be unreachable, it is possible that we shall treat as reachable some objects in the target set that really have no path from the root set.

We can adapt the garbage collectors described in Sections 7.6.1 and 7.6.4 to work in a partial manner by changing the definition of the "root set." Instead of referring to just the objects held in the registers, stack and global variables, the root set now also includes all the objects in the stable set that point to objects in the target set. References from target objects to other target objects are traced as before to find all the reachable objects. We can ignore all pointers to stable objects, because these objects are all considered reachable in this round of partial collection.

To identify those stable objects that reference target objects, we can adopt techniques similar to those used in incremental garbage collection. In incremental collection, we need to remember all the writes of references from scanned objects to unreached objects during the tracing process. Here we need to remember all the writes of references from the stable objects to the target objects throughout the mutator's execution. Whenever the mutator stores into a stable object a reference to an object in the target set, we remember either the reference or the location of the write. We refer to the set of objects holding references from the stable to the target objects as the *remembered set* for this set of target objects. As discussed in Section 7.7.2, we can compress the representation of a remembered set by recording only the card or page in which the written object is found.

Partial garbage collectors are often implemented as copying garbage collectors. Noncopying collectors can also be implemented by using linked lists to keep track of the reachable objects. The "generational" scheme described below is an example of how copying may be combined with partial collection.

#### 7.7.4 Generational Garbage Collection

Generational garbage collection is an effective way to exploit the property that most objects die young. The heap storage in generational garbage collection is separated into a series of partitions. We shall use the convention of numbering them  $0, 1, 2, \dots, n$ , with the lower-numbered partitions holding the younger objects. Objects are first created in partition 0. When this partition fills up, it is garbage collected, and its reachable objects are moved into partition 1. Now, with partition 0 empty again, we resume allocating new objects in that

partition. When partition 0 again fills,<sup>6</sup> it is garbage collected and its reachable objects copied into partition 1, where they join the previously copied objects. This pattern repeats until partition 1 also fills up, at which point garbage collection is applied to partitions 0 and 1.

In general, each round of garbage collection is applied to all partitions numbered  $i$  or below, for some  $i$ ; the proper  $i$  to choose is the highest-numbered partition that is currently full. Each time an object survives a collection (i.e., it is found to be reachable), it is promoted to the next higher partition from the one it occupies, until it reaches the oldest partition, the one numbered  $n$ .

Using the terminology introduced in Section 7.7.3, when partitions  $i$  and below are garbage collected, the partitions from 0 through  $i$  make up the target set, and all partitions above  $i$  comprise the stable set. To support finding root sets for all possible partial collections, we keep for each partition  $i$  a *remembered set*, consisting of all the objects in partitions above  $i$  that point to objects in set  $i$ . The root set for a partial collection invoked on set  $i$  includes the remembered sets for partition  $i$  and below.

In this scheme, all partitions below  $i$  are collected whenever we collect  $i$ . There are two reasons for this policy:

1. Since younger generations contain more garbage and are collected more often anyway, we may as well collect them along with an older generation.
2. Following this strategy, we need to remember only the references pointing from an older generation to a newer generation. That is, neither writes to objects in the youngest generation nor promoting objects to the next generation causes updates to any remembered set. If we were to collect a partition without a younger one, the younger generation would become part of the stable set, and we would have to remember references that point from younger to older generations as well.

In summary, this scheme collects younger generations more often, and collections of these generations are particularly cost effective, since "objects die young." Garbage collection of older generations takes more time, since it includes the collection of all the younger generations and contains proportionally less garbage. Nonetheless, older generations do need to be collected once in a while to remove unreachable objects. The oldest generation holds the most mature objects; its collection is expensive because it is equivalent to a full collection. That is, generational collectors occasionally require that the full tracing step be performed and therefore can introduce long pauses into a program's execution. An alternative for handling mature objects only is discussed next.

<sup>6</sup>technically, partitions do not "fill," since they can be expanded with additional disk blocks by the memory manager, if desired. However, there is normally a limit on the size of a partition, other than the last. We shall refer to reaching this limit as "filling" the partition.



### 7.7.5 The Train Algorithm

While the generational approach is very efficient for the handling of immature objects, it is less efficient for the mature objects, since mature objects are moved every time there is a collection involving them, and they are quite unlikely to be garbage. A different approach to incremental collection, called the *train algorithm*, was developed to improve the handling of mature objects. It can be used for collecting all garbage, but it is probably better to use the generational approach for immature objects and, only after they have survived a few rounds of collection, "promote" them to another heap, managed by the train algorithm. Another advantage to the train algorithm is that we never have to do a complete garbage collection, as we do occasionally for generational garbage collection.

To motivate the train algorithm, let us look at a simple example of why it is necessary, in the generational approach, to have occasional all-inclusive rounds of garbage collection. Figure 7.29 shows two mutually linked objects in two partitions  $i$  and  $j$ , where  $j > i$ . Since both objects have pointers from outside their partition, a collection of only partition  $i$  or only partition  $j$  could never collect either of these objects. Yet they may in fact be part of a cyclic garbage structure with no links from the outside. In general, the "links" between the objects shown may involve many objects and long chains of references.



Figure 7.29: A cyclic structure across partitions that may be cyclic garbage

In generational garbage collection, we eventually collect partition  $j$ , and since  $i < j$ , we also collect  $i$  at that time. Then, the cyclic structure will be completely contained in the portion of the heap being collected, and we can tell if it truly is garbage. However, if we never have a round of collection that includes both  $i$  and  $j$ , we would have a problem with cyclic garbage, just as we did with reference counting for garbage collection.

The train algorithm uses fixed-length partitions, called *cars*; a car might be a single disk block, provided there are no objects larger than disk blocks, or the car size could be larger, but it is fixed once and for all. Cars are organized into *trains*. There is no limit to the number of cars in a train, and no limit to the number of trains. There is a lexicographic order to cars: first order by train number, and within a train, order by car number, as in Fig. 7.30.

There are two ways that garbage is collected by the train algorithm:

- The first car in lexicographic order (that is, the first remaining car of the first remaining train) is collected in one incremental garbage-collection step. This step is similar to collection of the first partition in the generational algorithm, since we maintain a "remembered" list of all pointers

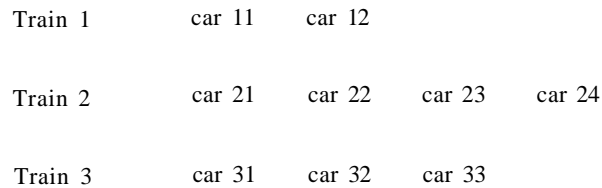

Figure 7.30: Organization of the heap for the train algorithm

from outside the car. Here, we identify objects with no references at all, as well as garbage cycles that are contained completely within this car. Reachable objects in the car are always moved to some other car, so each garbage-collected car becomes empty and can be removed from the train.

- Sometimes, the first train has no external references. That is, there are no pointers from the root set to any car of the train, and the remembered sets for the cars contain only references from other cars in the train, not from other trains. In this situation, the train is a huge collection of cyclic garbage, and we delete the entire train.

### Remembered Sets

We now give the details of the train algorithm. Each car has a remembered set consisting of all references to objects in the car from

- Objects in higher-numbered cars of the same train, and
- Objects in higher-numbered trains.

In addition, each train has a remembered set consisting of all references from higher-numbered trains. That is, the remembered set for a train is the union of the remembered sets for its cars, except for those references that are internal to the train. It is thus possible to represent both kinds of remembered sets by dividing the remembered sets for the cars into "internal" (same train) and "external" (other trains) portions.

Note that references to objects can come from anywhere, not just from lexicographically higher cars. However, the two garbage-collection processes deal with the first car of the first train, and the entire first train, respectively. Thus, when it is time to use the remembered sets in a garbage collection, there is nothing earlier from which references could come, and therefore there is no point in remembering references to higher cars at any time. We must be careful, of course, to manage the remembered sets properly, changing them whenever the mutator modifies references in any object.

### Managing Trains

Our objective is to draw out of the first train all objects that are not cyclic garbage. Then, the first train either becomes nothing but cyclic garbage and is therefore collected at the next round of garbage collection, or if the garbage is not cyclic, then its cars may be collected one at a time.

We therefore need to start new trains occasionally, even though there is no limit on the number of cars in one train, and we could in principle simply add new cars to a single train, every time we needed more space. For example, we could start a new train after every  $k$  object creations, for some  $k$ . That is, in general, a new object is placed in the last car of the last train, if there is room, or in a new car that is added to the end of the last train, if there is no room. However, periodically, we instead start a new train with one car, and place the new object there.

### Garbage Collecting a Car

The heart of the train algorithm is how we process the first car of the first train during a round of garbage collection. Initially, the reachable set is taken to be the objects of that car with references from the root set and those with references in the remembered set for that car. We then scan these objects as in a mark-and-sweep collector, but we do not scan any reached objects outside the one car being collected. After this tracing, some objects in the car may be identified as garbage. There is no need to reclaim their space, because the entire car is going to disappear anyway.

However, there are likely to be some reachable objects in the car, and these must be moved somewhere else. The rules for moving an object are:

- If there is a reference in the remembered set from any other train (which will be higher-numbered than the train of the car being collected), then move the object to one of those trains. If there is room, the object can go in some existing car of the train from which a reference emanates, or it can go in a new, last car if there is no room.
- If there is no reference from other trains, but there are references from the root set or from the first train, then move the object to any other car of the same train, creating a new, last car if there is no room. If possible, pick a car from which there is a reference, to help bring cyclic structures to a single car.

After moving all the reachable objects from the first car, we delete that car.

### Panic Mode

There is one problem with the rules above. In order to be sure that all garbage will eventually be collected, we need to be sure that every train eventually becomes the first train, and if this train is not cyclic garbage, then eventually

all cars of that train are removed and the train disappears one car at a time. However, by rule (2) above, collecting the first car of the first train can produce a new last car. It cannot produce two or more new cars, since surely all the objects of the first car can fit in the new, last car. However, could we be in a situation where each collection step for a train results in a new car being added, and we never get finished with this train and move on to the other trains?

The answer is, unfortunately, that such a situation is possible. The problem arises if we have a large, cyclic, nongarbage structure, and the mutator manages to change references in such a way that we never see, at the time we collect a car, any references from higher trains in the remembered set. If even one object is removed from the train during the collection of a car, then we are OK, since no new objects are added to the first train, and therefore the first train will surely run out of objects eventually. However, there may be no garbage at all that we can collect at a stage, and we run the risk of a loop where we perpetually garbage collect only the current first train.

To avoid this problem, we need to behave differently whenever we encounter a *futile* garbage collection, that is, a car from which not even one object can be deleted as garbage or moved to another train. In this "panic mode," we make two changes:

1. When a reference to an object in the first train is rewritten, we maintain the reference as a new member of the root set.
2. When garbage collecting, if an object in the first car has a reference from the root set, including dummy references set up by point (1), then we move that object to another train, even if it has no references from other trains. It is not important which train we move it to, as long as it is not the first train.

In this way, if there are any references from outside the first train to objects in the first train, these references are considered as we collect every car, and eventually some object will be removed from that train. We can then leave panic mode and proceed normally, sure that the current first train is now smaller than it was.

### 7.7.6 Exercises for Section 7.7

Exercise 7.7.1: Suppose that the network of objects from Fig. 7.20 is managed by an incremental algorithm that uses the four lists *Unreached*, *Unscanned*, *Scanned*, and *Free*, as in Baker's algorithm. To be specific, the *Unscanned* list is managed as a queue, and when more than one object is to be placed on this list due to the scanning of one object, we do so in alphabetical order. Suppose also that we use write barriers to assure that no reachable object is made garbage. Starting with *A* and *B* on the *Unscanned* list, suppose the following events occur:

- i.* *A* is scanned.

- ii. The pointer  $A \rightarrow D$  is rewritten to be  $A \rightarrow iJ$ .
- m.  $i?$  is scanned.
- iv.  $D$  is scanned.
- v. The pointer  $5 \rightarrow C$  is rewritten to be  $I? \quad /$ .

Simulate the entire incremental garbage collection, assuming no more pointers are rewritten. Which objects are garbage? Which objects are placed on the *Free* list?

**Exercise 7.7.2:** Repeat Exercise 7.7.1 on the assumption that

- a) Events (ii) and (v) are interchanged in order.
- b) Events (ii) and (v) occur before (i), (Hi), and (iv).

**Exercise 7.7.3:** Suppose the heap consists of exactly the nine cars on three trains shown in Fig. 7.30 (i.e., ignore the ellipses). Object  $o$  in car 11 has references from cars 12, 23, and 32. When we garbage collect car 11, where might  $o$  wind up?

**Exercise 7.7.4:** Repeat Exercise 7.7.3 for the cases that  $o$  has

- a) Only references from cars 22 and 31.
- b) No references other than from car 11.

**Exercise 7.7.5:** Suppose the heap consists of exactly the nine cars on three trains shown in Fig. 7.30 (i.e., ignore the ellipses). We are currently in panic mode. Object  $oi$  in car 11 has only one reference, from object  $o_i$  in car 12. That reference is rewritten. When we garbage collect car 11, what could happen to  $oi$ ?

## 7.8 Advanced Topics in Garbage Collection

We close our investigation of garbage collection with brief treatments of four additional topics:

1. Garbage collection in parallel environments.
2. Partial relocations of objects.
3. Garbage collection for languages that are not type-safe.
4. The interaction between programmer-controlled and automatic garbage collection.

### 7.8.1 Parallel and Concurrent Garbage Collection

Garbage collection becomes even more challenging when applied to applications running in parallel on a multiprocessor machine. It is not uncommon for server applications to have thousands of threads running at the same time; each of these threads is a mutator. Typically, the heap will consist of gigabytes of memory.

Scalable garbage-collection algorithms must take advantage of the presence of multiple processors. We say a garbage collector is *parallel* if it uses multiple threads; it is *concurrent* if it runs simultaneously with the mutator.

We shall describe a parallel, and mostly concurrent, collector that uses a concurrent and parallel phase that does most of the tracing work, and then a stop-the-world phase that guarantees all the reachable objects are found and reclaims the storage. This algorithm introduces no new basic concepts in garbage collection per se; it shows how we can combine the ideas described so far to create a full solution to the parallel-and-concurrent collection problem. However, there are some new implementation issues that arise due to the nature of parallel execution. We shall discuss how this algorithm coordinates multiple threads in a parallel computation using a rather common work-queue model.

To understand the design of the algorithm we must keep in mind the scale of the problem. Even the root set of a parallel application is much larger, consisting of every thread's stack, register set and globally accessible variables. The amount of heap storage can be very large, and so is the amount of reachable data. The rate at which mutations take place is also much greater.

To reduce the pause time, we can adapt the basic ideas developed for incremental analysis to overlap garbage collection with mutation. Recall that an incremental analysis, as discussed in Section 7.7, performs the following three steps:

1. Find the root set. This step is normally performed atomically, that is, with the mutator(s) stopped.
2. Interleave the tracing of the reachable objects with the execution of the mutator(s). In this period, every time a mutator writes a reference that points from a *Scanned* object to an *Unreached* object, we remember that reference. As discussed in Section 7.7.2, we have options regarding the granularity with which these references are remembered. In this section, we shall assume the card-based scheme, where we divide the heap into sections called "cards" and maintain a bit map indicating which cards are *dirty* (have had one or more references within them rewritten).
3. Stop the mutator(s) again to rescan all the cards that may hold references to unreached objects.

For a large multithreaded application, the set of objects reached by the root set can be very large. It is infeasible to take the time and space to visit all such objects while all mutations cease. Also, due to the large heap and the large

number of mutation threads, many cards may need to be rescanned after all objects have been scanned once. It is thus advisable to scan some of these cards in parallel, while the mutators are allowed to continue to execute concurrently.

To implement the tracing of step (2) above, in parallel, we shall use multiple garbage-collecting threads concurrently with the mutator threads to trace *most* of the reachable objects. Then, to implement step (3), we stop the mutators and use parallel threads to ensure that all reachable objects are found.

The tracing of step (2) is carried out by having each mutator thread perform part of the garbage collection, along with its own work. In addition, we use threads that are dedicated purely to collecting garbage. Once garbage collection has been initiated, whenever a mutator thread performs some memory-allocation operation, it also performs some tracing computation. The pure garbage-collecting threads are put to use only when a machine has idle cycles. As in incremental analysis, whenever a mutator writes a reference that points from a *Scanned* object to an *Unreached* object, the card that holds this reference is marked dirty and needs to be rescanned.

Here is an outline of the parallel, concurrent garbage-collection algorithm.

1. Scan the root set for each mutator thread, and put all objects directly reachable from that thread into the *Unscanned* state. The simplest incremental approach to this step is to wait until a mutator thread calls the memory manager, and have it scan its own root set if that has not already been done. If some mutator thread has not called a memory allocation function, but all the rest of tracing is done, then this thread must be interrupted to have its root set scanned.
2. Scan objects that are in the *Unscanned* state. To support parallel computation, we use a work queue of fixed-size *work packets*, each of which holds a number of *Unscanned* objects. *Unscanned* objects are placed in work packets as they are discovered. Threads looking for work will dequeue these work packets and trace the *Unscanned* objects therein. This strategy allows the work to be spread evenly among workers in the tracing process. If the system runs out of space, and we cannot find the space to create these work packets, we simply mark the cards holding the objects to force them to be scanned. The latter is always possible because the bit array holding the marks for the cards has already been allocated.
3. Scan the objects in dirty cards. When there are no more *Unscanned* objects left in the work queue, and all threads' root sets have been scanned, the cards are rescanned for reachable objects. As long as the mutators continue to execute, dirty cards continue to be produced. Thus, we need to stop the tracing process using some criterion, such as allowing cards to be rescanned only once or a fixed number of times, or when the number of outstanding cards is reduced to some threshold. As a result, this parallel and concurrent step normally terminates before completing the trace, which is finished by the final step, below.

4. The final step guarantees that all reachable objects are marked as reached. With all the mutators stopped, the root sets for all the threads can now be found quickly using all the processors in the system. Because the reachability of most objects has been traced, only a small number of objects are expected to be placed in the *Unscanned* state. All the threads then participate in tracing the rest of the reachable objects and rescanning all the cards.

It is important that we control the rate at which tracing takes place. The tracing phase is like a race. The mutators create new objects and new references that must be scanned, and the tracing tries to scan all the reachable objects and rescan the dirty cards generated in the meanwhile. It is not desirable to start the tracing too much before a garbage collection is needed, because that will increase the amount of floating garbage. On the other hand, we cannot wait until the memory is exhausted before the tracing starts, because then mutators will not be able to make forward progress and the situation degenerates to that of a stop-the-world collector. Thus, the algorithm must choose the time to commence the collection and the rate of tracing appropriately. An estimate of the mutation rate from previous cycles of collection can be used to help in the decision. The tracing rate is dynamically adjusted to account for the work performed by the pure garbage-collecting threads.

## 7.8.2 Partial Object Relocation

As discussed starting in Section 7.6.4, copying or compacting collectors are advantageous because they eliminate fragmentation. However, these collectors have nontrivial overheads. A compacting collector requires moving all objects and updating all the references at the end of garbage collection. A copying collector figures out where the reachable objects go as tracing proceeds; if tracing is performed incrementally, we need either to translate a mutator's every reference, or to move all the objects and update their references at the end. Both options are very expensive, especially for a large heap.

We can instead use a copying generational garbage collector. It is effective in collecting immature objects and reducing fragmentation, but can be expensive when collecting mature objects. We can use the train algorithm to limit the amount of mature data analyzed each time. However, the overhead of the train algorithm is sensitive to the size of the remembered set for each partition.

There is a hybrid collection scheme that uses concurrent tracing to reclaim all the unreachable objects and at the same time moves only a part of the objects. This method reduces fragmentation without incurring the full cost of relocation in each collection cycle.

1. Before tracing begins, choose a part of the heap that will be evacuated.
2. As the reachable objects are marked, also remember all the references pointing to objects in the designated area.



3. When tracing is complete, sweep the storage in parallel to reclaim the space occupied by unreachable objects.
4. Finally, evacuate the reachable objects occupying the designated area and fix up the references to the evacuated objects.

### 7.8.3 Conservative Collection for Unsafe Languages

As discussed in Section 7.5.1, it is impossible to build a garbage collector that is guaranteed to work for all C and C++ programs. Since we can always compute an address with arithmetic operations, no memory locations in C and C++ can ever be shown to be unreachable. However, many C or C++ programs never fabricate addresses in this way. It has been demonstrated that a conservative garbage collector — one that does not necessarily discard all garbage — can be built to work well in practice for this class of programs.

A conservative garbage collector assumes that we cannot fabricate an address, or derive the address of an allocated chunk of memory without an address pointing somewhere in the same chunk. We can find all the garbage in programs satisfying such an assumption by treating as a valid address any bit pattern found anywhere in reachable memory, as long as that bit pattern may be construed as a memory location. This scheme may classify some data erroneously as addresses. It is correct, however, since it only causes the collector to be conservative and keep more data than necessary.

Object relocation, requiring all references to the old locations be updated to point to the new locations, is incompatible with conservative garbage collection. Since a conservative garbage collector does not know if a particular bit pattern refers to an actual address, it cannot change these patterns to point to new addresses.

Here is how a conservative garbage collector works. First, the memory manager is modified to keep a *data map* of all the allocated chunks of memory. This map allows us to find easily the starting and ending boundary of the chunk of memory that spans a certain address. The tracing starts by scanning the program's root set to find any bit pattern that looks like a memory location, without worrying about its type. By looking up these potential addresses in the data map, we can find the starting addresses of those chunks of memory that might be reached, and place them in the *Unscanned* state. We then scan all the unscanned chunks, find more (presumably) reachable chunks of memory, and place them on the work list until the work list becomes empty. After tracing is done, we sweep through the heap storage using the data map to locate and free all the unreachable chunks of memory.

### 7.8.4 Weak References

Sometimes, programmers use a language with garbage collection, but also wish to manage memory, or parts of memory, themselves. That is, a programmer may know that certain objects are never going to be accessed again, even though

references to the objects remain. An example from compiling will suggest the problem.

**Example 7.17:** We have seen that the lexical analyzer often manages a symbol table by creating an object for each identifier it sees. These objects may appear as lexical values attached to leaves of the parse tree representing those identifiers, for instance. However, it is also useful to create a hash table, keyed by the identifier's string, to locate these objects. That table makes it easier for the lexical analyzer to find the object when it encounters a lexeme that is an identifier.

When the compiler passes the scope of an identifier *J*, its symbol-table object no longer has any references from the parse tree, or probably any other intermediate structure used by the compiler. However, a reference to the object is still sitting in the hash table. Since the hash table is part of the root set of the compiler, the object cannot be garbage collected. If another identifier with the same lexeme as *J* is encountered, then it will be discovered that *J* is out of scope, and the reference to its object will be deleted. However, if no other identifier with this lexeme is encountered, then *J*'s object may remain as uncollectable, yet useless, throughout compilation. •

If the problem suggested by Example 7.17 is important, then the compiler writer could arrange to delete from the hash table all references to objects as soon as their scope ends. However, a technique known as *weak references* allows the programmer to rely on automatic garbage collection, and yet not have the heap burdened with reachable, yet truly unused, objects. Such a system allows certain references to be declared "weak." An example would be all the references in the hash table we have been discussing. When the garbage collector scans an object, it does not follow weak references within that object, and does not make the objects they point to reachable. Of course, such an object may still be reachable if there is another reference to it that is not weak.

### 7.8.5 Exercises for Section 7.8

! Exercise 7.8.1: In Section 7.8.3 we suggested that it was possible to garbage collect for C programs that do not fabricate expressions that point to a place within a chunk unless there is an address that points somewhere within that same chunk. Thus, we rule out code like

```
p = 12345;  
x = *p;
```

because, while *p* might point to some chunk accidentally, there could be no other pointer to that chunk. On the other hand, with the code above, it is more likely that *p* points nowhere, and executing that code will result in a segmentation fault. However, in C it is possible to write code such that a variable like *p* is guaranteed to point to some chunk, and yet there is no pointer to that chunk. Write such a program.

## 7.9 Summary of Chapter 7

- *Run-Time Organization.* To implement the abstractions embodied in the source language, a compiler creates and manages a run-time environment in concert with the operating system and the target machine. The run-time environment has static data areas for the object code and the static data objects created at compile time. It also has dynamic stack and heap areas for managing objects created and destroyed as the target program executes.
- *Control Stack.* Procedure calls and returns are usually managed by a run-time stack called the *control stack*. We can use a stack because procedure calls or *activations* nest in time; that is, if  $p$  calls  $q$ , then this activation of  $q$  is nested within this activation of  $p$ .
- *Stack Allocation.* Storage for local variables can be allocated on a run-time stack for languages that allow or require local variables to become inaccessible when their procedures end. For such languages, each live activation has an *activation record* (or *frame*) on the control stack, with the root of the activation tree at the bottom, and the entire sequence of activation records on the stack corresponding to the path in the activation tree to the activation where control currently resides. The latter activation has its record at the top of the stack.
- *Access to Nonlocal Data on the Stack.* For languages like C that do not allow nested procedure declarations, the location for a variable is either global or found in the activation record on top of the run-time stack. For languages with nested procedures, we can access nonlocal data on the stack through *access links*, which are pointers added to each activation record. The desired nonlocal data is found by following a chain of access links to the appropriate activation record. A *display* is an auxiliary array, used in conjunction with access links, that provides an efficient short-cut alternative to a chain of access links.
- *Heap Management.* The *heap* is the portion of the store that is used for data that can live indefinitely, or until the program deletes it explicitly. The *memory manager* allocates and deallocates space within the heap. *Garbage collection* finds spaces within the heap that are no longer in use and can therefore be reallocated to house other data items. For languages that require it, the garbage collector is an important subsystem of the memory manager.
- *Exploiting Locality.* By making good use of the memory hierarchy, memory managers can influence the run time of a program. The time taken to access different parts of memory can vary from nanoseconds to milliseconds. Fortunately, most programs spend most of their time executing a relatively small fraction of the code and touching only a small fraction of

the data. A program has *temporal locality* if it is likely to access the same memory locations again soon; it has *spatial locality* if it is likely to access nearby memory locations soon.

- 4 *Reducing Fragmentation.* As the program allocates and deallocates memory, the heap may get *fragmented*, or broken into large numbers of small noncontiguous free spaces or *holes*. The *best fit* strategy — allocate the smallest available hole that satisfies a request — has been found empirically to work well. While best fit tends to improve space utilization, it may not be best for spatial locality. Fragmentation can be reduced by combining or *coalescing* adjacent holes.
- 4 *Manual Deallocation.* Manual memory management has two common failings: not deleting data that can not be referenced is a *memory-leak* error, and referencing deleted data is a *dangling-pointer-dereference* error.
  - *Reachability.* *Garbage* is data that cannot be referenced or *reached*. There are two basic ways of finding unreachable objects: either catch the transition as a reachable object turns unreachable, or periodically locate all reachable objects and infer that all remaining objects are unreachable.
  - *Reference-Counting Collectors* maintain a count of the references to an object; when the count transitions to zero, the object becomes unreachable. Such collectors introduce the overhead of maintaining references and can fail to find "cyclic" garbage, which consists of unreachable objects that reference each other, perhaps through a chain of references.
  - *Trace-Based Garbage Collectors* iteratively examine or trace all references to find reachable objects, starting with the *root set* consisting of objects that can be accessed directly without having to dereference any pointers.
- 4 *Mark-and-Sweep Collectors* visit and mark all reachable objects in a first tracing step and then sweep the heap to free up unreachable objects.
- 4- *Mark-and-Compact Collectors* improve upon mark-and-sweep; they *relocate* reachable objects in the heap to eliminate memory fragmentation.
- 4 *Copying Collectors* break the dependency between tracing and finding free space. They partition the memory into two *semispaces*, *A* and *B*. Allocation requests are satisfied from one semispace, say *A*, until it fills up, at which point the garbage collector takes over, copies the reachable objects to the other space, say *B*, and reverses the roles of the semispaces.
- 4 *Incremental Collectors.* Simple trace-based collectors stop the user program while garbage is collected. *Incremental collectors* interleave the actions of the garbage collector and the *mutator* or user program. The mutator can interfere with incremental reachability analysis, since it can

change the references within previously scanned objects. Incremental collectors therefore play it safe by overestimating the set of reachable objects; any "floating garbage" can be picked up in the next round of collection.

- *Partial Collectors* also reduce pauses; they collect a subset of the garbage at a time. The best known of partial-collection algorithms, *generational garbage collection*, partitions objects according to how long they have been allocated and collects the newly created objects more often because they tend to have shorter lifetimes. An alternative algorithm, the *train algorithm*, uses fixed length partitions, called *cars*, that are collected into *trains*. Each collection step is applied to the first remaining car of the first remaining train. When a car is collected, reachable objects are moved out to other cars, so this car is left with garbage and can be removed from the train. These two algorithms can be used together to create a partial collector that applies the generational algorithm to younger objects and the train algorithm to more mature objects.

## 7.10 References for Chapter 7

In mathematical logic, scope rules and parameter passing by substitution date back to Frege [8]. Church's lambda calculus [3] uses lexical scope; it has been used as a model for studying programming languages. Algol 60 and its successors, including C and Java, use lexical scope. Once introduced by the initial implementation of Lisp, dynamic scope became a feature of the language; McCarthy [14] gives the history.

Many of the concepts related to stack allocation were stimulated by blocks and recursion in Algol 60. The idea of a display for accessing nonlocals in a lexically scoped language is due to Dijkstra [5]. A detailed description of stack allocation, the use of a display, and dynamic allocation of arrays appears in Randell and Russell [16]. Johnson and Ritchie [10] discuss the design of a calling sequence that allows the number of arguments of a procedure to vary from call to call.

Garbage collection has been an active area of investigation; see for example Wilson [17]. Reference counting dates back to Collins [4]. Trace-based collection dates back to McCarthy [13], who describes a mark-sweep algorithm for fixed-length cells. The boundary-tag for managing free space was designed by Knuth in 1962 and published in [11].

Algorithm 7.14 is based on Baker [1]. Algorithm 7.16 is based on Cheney's [2] nonrecursive version of Fenichel and Yochelson's [7] copying collector.

Incremental reachability analysis is explored by Dijkstra et al. [6]. Lieberman and Hewitt [12] present a generational collector as an extension of copying collection. The train algorithm began with Hudson and Moss [9].

1. Baker, H. G. Jr., "The treadmill: real-time garbage collection without motion sickness," *ACM SIGPLAN Notices* 27:3 (Mar., 1992), pp. 66-70.

2. Cheney, C. J., "A nonrecursive list compacting algorithm," *Comm. ACM* **13**:11 (Nov., 1970), pp. 677-678.
3. Church, A., *The Calculi of Lambda Conversion*, Annals of Math. Studies, No. 6, Princeton University Press, Princeton, N. J., 1941.
4. Collins, G. E., "A method for overlapping and erasure of lists," *Comm. ACM* **2**:12 (Dec, 1960), pp. 655-657.
5. Dijkstra, E. W., "Recursive programming," *Numerische Math.* **2** (1960), pp. 312-318.
6. Dijkstra, E. W., L. Lamport, A. J. Martin, C. S. Scholten, and E. F. M. Steffens, "On-the-fly garbage collection: an exercise in cooperation," *Comm. ACM* **21**:11 (1978), pp. 966-975.
7. Fenichel, R. R. and J. C. Yochelson, "A Lisp garbage-collector for virtual-memory computer systems", *Comm. ACM* **12**:11 (1969), pp. 611-612.
8. Frege, G., "Begriffsschrift, a formula language, modeled upon that of arithmetic, for pure thought," (1879). In J. van Heijenoort, *From Frege to Gbdel*, Harvard Univ. Press, Cambridge MA, 1967.
9. Hudson, R. L. and J. E. B. Moss, "Incremental Collection of Mature Objects", *Proc. Intl. Workshop on Memory Management*, Lecture Notes In Computer Science **637** (1992), pp. 388-403.
10. Johnson, S. C. and D. M. Ritchie, "The C language calling sequence," Computing Science Technical Report 102, Bell Laboratories, Murray Hill NJ, 1981.
11. Knuth, D. E., *Art of Computer Programming, Volume 1: Fundamental Algorithms*, Addison-Wesley, Boston MA, 1968.
12. Lieberman, H. and C. Hewitt, "A real-time garbage collector based on the lifetimes of objects," *Comm. ACM* **26**:6 (June 1983), pp. 419-429.
13. McCarthy, J., "Recursive functions of symbolic expressions and their computation by machine," *Comm. ACM* **3**:4 (Apr., 1960), pp. 184-195.
14. McCarthy, J., "History of Lisp." See pp. 173-185 in R. L. Wexelblat (ed.), *History of Programming Languages*, Academic Press, New York, 1981.
15. Minsky, M., "A LISP garbage collector algorithm using secondary storage," A. I. Memo 58, MIT Project MAC, Cambridge MA, 1963.
16. Randell, B. and L. J. Russell, *Algol 60 Implementation*, Academic Press, New York, 1964.
17. Wilson, P. R., "Uniprocessor garbage collection techniques,"

<ftp://ftp.cs.utexas.edu/pub/garbage/bigsurv.ps>



# Chapter 8

## Code Generation

The final phase in our compiler model is the code generator. It takes as input the intermediate representation (IR) produced by the front end of the compiler, along with relevant symbol table information, and produces as output a semantically equivalent target program, as shown in Fig. 8.1.

The requirements imposed on a code generator are severe. The target program must preserve the semantic meaning of the source program and be of high quality; that is, it must make effective use of the available resources of the target machine. Moreover, the code generator itself must run efficiently.

The challenge is that, mathematically, the problem of generating an optimal target program for a given source program is undecidable; many of the subproblems encountered in code generation such as register allocation are computationally intractable. In practice, we must be content with heuristic techniques that generate good, but not necessarily optimal, code. Fortunately, heuristics have matured enough that a carefully designed code generator can produce code that is several times faster than code produced by a naive one.

Compilers that need to produce efficient target programs, include an optimization phase prior to code generation. The optimizer maps the IR into IR from which more efficient code can be generated. In general, the code-optimization and code-generation phases of a compiler, often referred to as the *back end*, may make multiple passes over the IR before generating the target program. Code optimization is discussed in detail in Chapter 9. The techniques presented in this chapter can be used whether or not an optimization phase occurs before code generation.

A code generator has three primary tasks: instruction selection, register

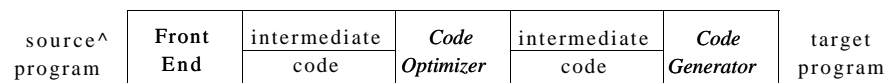

Figure 8.1: Position of code generator



allocation and assignment, and instruction ordering. The importance of these tasks is outlined in Section 8.1. Instruction selection involves choosing appropriate target-machine instructions to implement the IR statements. Register allocation and assignment involves deciding what values to keep in which registers. Instruction ordering involves deciding in what order to schedule the execution of instructions.

This chapter presents algorithms that code generators can use to translate the IR into a sequence of target language instructions for simple register machines. The algorithms will be illustrated by using the machine model in Section 8.2. Chapter 10 covers the problem of code generation for complex modern machines that support a great deal of parallelism within a single instruction.

After discussing the broad issues in the design of a code generator, we show what kind of target code a compiler needs to generate to support the abstractions embodied in a typical source language. In Section 8.3, we outline implementations of static and stack allocation of data areas, and show how names in the IR can be converted into addresses in the target code.

Many code generators partition IR instructions into "basic blocks," which consist of sequences of instructions that are always executed together. The partitioning of the IR into basic blocks is the subject of Section 8.4. The following section presents simple local transformations that can be used to transform basic blocks into modified basic blocks from which more efficient code can be generated. These transformations are a rudimentary form of code optimization, although the deeper theory of code optimization will not be taken up until Chapter 9. An example of a useful, local transformation is the discovery of common subexpressions at the level of intermediate code and the resultant replacement of arithmetic operations by simpler copy operations.

Section 8.6 presents a simple code-generation algorithm that generates code for each statement in turn, keeping operands *in* registers as long as possible. The output of this kind of code generator can be readily improved by peephole optimization techniques such as those discussed in the following Section 8.7.

The remaining sections explore instruction selection and register allocation.

## 8.1 Issues in the Design of a Code Generator

While the details are dependent on the specifics of the intermediate representation, the target language, and the run-time system, tasks such as instruction selection, register allocation and assignment, and instruction ordering are encountered in the design of almost all code generators.

The most important criterion for a code generator is that it produce correct code. Correctness takes on special significance because of the number of special cases that a code generator might face. Given the premium on correctness, designing a code generator so it can be easily implemented, tested, and maintained is an important design goal.

### 8.1.1 Input to the Code Generator

The input to the code generator is the intermediate representation of the source program produced by the front end, along with information in the symbol table that is used to determine the run-time addresses of the data objects denoted by the names in the IR.

The many choices for the IR include three-address representations such as quadruples, triples, indirect triples; virtual machine representations such as bytecodes and stack-machine code; linear representations such as postfix notation; and graphical representations such as syntax trees and DAG's. Many of the algorithms in this chapter are couched in terms of the representations considered in Chapter 6: three-address code, trees, and DAG's. The techniques we discuss can be applied, however, to the other intermediate representations as well.

In this chapter, we assume that the front end has scanned, parsed, and translated the source program into a relatively low-level IR, so that the values of the names appearing in the IR can be represented by quantities that the target machine can directly manipulate, such as integers and floating-point numbers. We also assume that all syntactic and static semantic errors have been detected, that the necessary type checking has taken place, and that type-conversion operators have been inserted wherever necessary. The code generator can therefore proceed on the assumption that its input is free of these kinds of errors.

### 8.1.2 The Target Program

The instruction-set architecture of the target machine has a significant impact on the difficulty of constructing a good code generator that produces high-quality machine code. The most common target-machine architectures are RISC (reduced instruction set computer), CISC (complex instruction set computer), and stack based.

A RISC machine typically has many registers, three-address instructions, simple addressing modes, and a relatively simple instruction-set architecture. In contrast, a CISC machine typically has few registers, two-address instructions, a variety of addressing modes, several register classes, variable-length instructions, and instructions with side effects.

In a stack-based machine, operations are done by pushing operands onto a stack and then performing the operations on the operands at the top of the stack. To achieve high performance the top of the stack is typically kept in registers. Stack-based machines almost disappeared because it was felt that the stack organization was too limiting and required too many swap and copy operations.

However, stack-based architectures were revived with the introduction of the Java Virtual Machine (JVM). The JVM is a software interpreter for Java bytecodes, an intermediate language produced by Java compilers. The inter-

preter provides software compatibility across multiple platforms, a major factor in the success of Java.

To overcome the high performance penalty of interpretation, which can be on the order of a factor of 10, *just-in-time* (JIT) Java compilers have been created. These JIT compilers translate bytecodes during run time to the native hardware instruction set of the target machine. Another approach to improving Java performance is to build a compiler that compiles directly into the machine instructions of the target machine, bypassing the Java bytecodes entirely.

Producing an absolute machine-language program as output has the advantage that it can be placed in a fixed location in memory and immediately executed. Programs can be compiled and executed quickly.

Producing a relocatable machine-language program (often called an *object module*) as output allows subprograms to be compiled separately. A set of relocatable object modules can be linked together and loaded for execution by a linking loader. Although we must pay the added expense of linking and loading if we produce relocatable object modules, we gain a great deal of flexibility in being able to compile subroutines separately and to call other previously compiled programs from an object module. If the target machine does not handle relocation automatically, the compiler must provide explicit relocation information to the loader to link the separately compiled program modules.

Producing an assembly-language program as output makes the process of code generation somewhat easier. We can generate symbolic instructions and use the macro facilities of the assembler to help generate code. The price paid is the assembly step after code generation.

In this chapter, we shall use a very simple RISC-like computer as our target machine. We add to it some CISC-like addressing modes so that we can also discuss code-generation techniques for CISC machines. For readability, we use assembly code as the target language. As long as addresses can be calculated from offsets and other information stored in the symbol table, the code generator can produce relocatable or absolute addresses for names just as easily as symbolic addresses.

### 8.1.3 Instruction Selection

The code generator must map the IR program into a code sequence that can be executed by the target machine. The complexity of performing this mapping is determined by a factors such as

- the level of the IR
- the nature of the instruction-set architecture
- the desired quality of the generated code.

If the IR is high level, the code generator may translate each IR statement into a sequence of machine instructions using code templates. Such statement-by-statement code generation, however, often produces poor code that needs

further optimization. If the IR reflects some of the low-level details of the underlying machine, then the code generator can use this information to generate more efficient code sequences.

The nature of the instruction set of the target machine has a strong effect on the difficulty of instruction selection. For example, the uniformity and completeness of the instruction set are important factors. If the target machine does not support each data type in a uniform manner, then each exception to the general rule requires special handling. On some machines, for example, floating-point operations are done using separate registers.

Instruction speeds and machine idioms are other important factors. If we do not care about the efficiency of the target program, instruction selection is straightforward. For each type of three-address statement, we can design a code skeleton that defines the target code to be generated for that construct. For example, every three-address statement of the form  $x = y + z$ , where  $x$ ,  $y$ , and  $z$  are statically allocated, can be translated into the code sequence

```
LD  RO, y      // RO = y      (load y into register RO)
ADD RO, RO, z  // RO = RO + z (add z to RO)
ST  x, RO      // x = RO      (store RO into x)
```

This strategy often produces redundant loads and stores. For example, the sequence of three-address statements

```
a = b + c
d = a + e
```

would be translated into

```
LD  RO, b      // RO = b
ADD RO, RO, c  // RO = RO
ST  a, RO      // a == RO
LD  RO, a      // RO = a
ADD RO, RO, e  // RO = RO
ST  d, RO      // d == RO
```

Here, the fourth statement is redundant since it loads a value that has just been stored, and so is the third if  $a$  is not subsequently used.

The quality of the generated code is usually determined by its speed and size. On most machines, a given IR program can be implemented by many different code sequences, with significant cost differences between the different implementations. A naive translation of the intermediate code may therefore lead to correct but unacceptably inefficient target code.

For example, if the target machine has an "increment" instruction (**INC**), then the three-address statement  $a = a + 1$  may be implemented more efficiently by the single instruction **INC a**, rather than by a more obvious sequence that loads  $a$  into a register, adds one to the register, and then stores the result back into  $a$ :

```
LD R0, a      // RO = a
ADD RO, RO, #1 // RO = RO + 1
ST a, RO      // a = RO
```

We need to know instruction costs in order to design good code sequences but, unfortunately, accurate cost information is often difficult to obtain. Deciding which machine-code sequence is best for a given three-address construct may also require knowledge about the context in which that construct appears.

In Section 8.9 we shall see that instruction selection can be modeled as a tree-pattern matching process in which we represent the IR and the machine instructions as trees. We then attempt to "tile" an IR tree with a set of subtrees that correspond to machine instructions. If we associate a cost with each machine-instruction subtree, we can use dynamic programming to generate optimal code sequences. Dynamic programming is discussed in Section 8.11.

### 8.1.4 Register Allocation

A key problem in code generation is deciding what values to hold in what registers. Registers are the fastest computational unit on the target machine, but we usually do not have enough of them to hold all values. Values not held in registers need to reside in memory. Instructions involving register operands are invariably shorter and faster than those involving operands in memory, so efficient utilization of registers is particularly important.

The use of registers is often subdivided into two subproblems:

1. *Register allocation*, during which we select the set of variables that will reside in registers at each point in the program.
2. *Register assignment*, during which we pick the specific register that a variable will reside in.

Finding an optimal assignment of registers to variables is difficult, even with single-register machines. Mathematically, the problem is NP-complete. The problem is further complicated because the hardware and/or the operating system of the target machine may require that certain register-usage conventions be observed.

Example 8.1: Certain machines require *register-pairs* (an even and next odd-numbered register) for some operands and results. For example, on some machines, integer multiplication and integer division involve register pairs. The multiplication instruction is of the form

$$M\ x, y$$

where  $x$ , the multiplicand, is the even register of an even/odd register pair and  $y$ , the multiplier, is the odd register. The product occupies the entire even/odd register pair. The division instruction is of the form

D  $x, y$

where the dividend occupies an even/odd register pair whose even register is  $x$ ; the divisor is  $y$ . After division, the even register holds the remainder and the odd register the quotient.

Now, consider the two three-address code sequences in Fig. 8.2 in which the only difference in (a) and (b) is the operator in the second statement. The shortest assembly-code sequences for (a) and (b) are given in Fig. 8.3.

$t = a + b$ $t = t * c$ $t = t / d$	$t = a + b$ $t = t + c$ $t = t / d$
(a)	(b)

Figure 8.2: Two three-address code sequences

L R1, a A R1, b M R0, c D R0, d ST R1, t	L RO, a A RO, b A RO, c SRDA RO, 32 D RO, d ST R1, t
(a)	(b)

Figure 8.3: Optimal machine-code sequences

$Ri$  stands for register  $i$ . **SRDA** stands for Shift-Right-Double-Arithmetic and **SRDA RO, 32** shifts the dividend into **R1** and clears **RO** so all bits equal its sign bit. **L**, **ST**, and **A** stand for load, store, and add, respectively. Note that the optimal choice for the register into which  $a$  is to be loaded depends on what will ultimately happen to  $t$ . •

Strategies for register allocation and assignment are discussed in Section 8.8. Section 8.10 shows that for certain classes of machines we can construct code sequences that evaluate expressions using as few registers as possible.

### 8.1.5 Evaluation Order

The order in which computations are performed can affect the efficiency of the target code. As we shall see, some computation orders require fewer registers to hold intermediate results than others. However, picking a best order in the general case is a difficult NP-complete problem. Initially, we shall avoid

the problem by generating code for the three-address statements in the order in which they have been produced by the intermediate code generator. In Chapter 10, we shall study code scheduling for pipelined machines that can execute several operations in a single clock cycle.

## 8.2 The Target Language

Familiarity with the target machine and its instruction set is a prerequisite for designing a good code generator. Unfortunately, in a general discussion of code generation it is not possible to describe any target machine in sufficient detail to generate good code for a complete language on that machine. In this chapter, we shall use as a target language assembly code for a simple computer that is representative of many register machines. However, the code-generation techniques presented in this chapter can be used on many other classes of machines as well.

### 8.2.1 A Simple Target Machine Model

Our target computer models a three-address machine with load and store operations, computation operations, jump operations, and conditional jumps. The underlying computer is a byte-addressable machine with  $n$  general-purpose registers,  $R_0, R_1, \dots, R_{n-1}$ . A full-fledged assembly language would have scores of instructions. To avoid hiding the concepts in a myriad of details, we shall use a very limited set of instructions and assume that all operands are integers. Most instructions consists of an operator, followed by a target, followed by a list of source operands. A label may precede an instruction. We assume the following kinds of instructions are available:

- *Load operations:* The instruction **LD** *dst, addr* loads the value in location *addr* into location *dst*. This instruction denotes the assignment  $dst = addr$ . The most common form of this instruction is **LD** *r, x* which loads the value in location *x* into register *r*. An instruction of the form **LD**  $r_1, r_2$  is a *register-to-register copy* in which the contents of register  $r_2$  are copied into register  $r_1$ .
- *Store operations:* The instruction **ST** *x, r* stores the value in register *r* into the location *x*. This instruction denotes the assignment  $x = r$ .
- *Computation operations* of the form **OP** *dst, src<sub>1</sub>, src<sub>2</sub>*, where *OP* is a operator like **ADD** or **SUB**, and *dst, src<sub>1</sub>*, and *src<sub>2</sub>* are locations, not necessarily distinct. The effect of this machine instruction is to apply the operation represented by *OP* to the values in locations *src<sub>1</sub>* and *src<sub>2</sub>*, and place the result of this operation in location *dst*. For example, **SUB**  $n, r_2, r_1$  computes  $n = r_2 - r_1$ . Any value formerly stored in *n* is lost, but if  $r_1$  is  $r_2$  or  $r_3$ , the old value is read first. Unary operators that take only one operand do not have a *src<sub>2</sub>*.

- *Unconditional jumps:* The instruction `BR L` causes control to branch to the machine instruction with label *L*. (BR stands for *branch*.)
- *Conditional jumps* of the form `Bcond r, L`, where *r* is a register, *L* is a label, and *cond* stands for any of the common tests on values in the register *r*. For example, `BLTZ r, L` causes a jump to label *L* if the value in register *r* is less than zero, and allows control to pass to the next machine instruction if not.

We assume our target machine has a variety of addressing modes:

- In instructions, a location can be a variable name *x* referring to the memory location that is reserved for *x* (that is, the */*-value of *x*).
- A location can also be an indexed address of the form *a(r)*, where *a* is a variable and *r* is a register. The memory location denoted by *a(r)* is computed by taking the */*-value of *a* and adding to it the value in register *r*. For example, the instruction `LD R1, a(R2)` has the effect of setting  $R1 = contents(a + contents(R2))$ , where *contents(x)* denotes the contents of the register or memory location represented by *x*. This addressing mode is useful for accessing arrays, where *a* is the base address of the array (that is, the address of the first element), and *r* holds the number of bytes past that address we wish to go to reach one of the elements of array *a*.
- A memory location can be an integer indexed by a register. For example, `LD R1, 100(R2)` has the effect of setting  $R1 = contents(100 + contents(R2))$ , that is, of loading into *R1* the value in the memory location obtained by adding `100` to the contents of register `R2`. This feature is useful for following pointers, as we shall see in the example below.
- We also allow two indirect addressing modes: `*r` means the memory location found in the location represented by the contents of register *r* and `*100(r)` means the memory location found in the location obtained by adding `100` to the contents of *r*. For example, `LD R1, *100(R2)` has the effect of setting  $R1 = contents(contents(100 + contents(R2)))$ , that is, of loading into *R1* the value in the memory location stored in the memory location obtained by adding `100` to the contents of register `R2`.
- Finally, we allow an immediate constant addressing mode. The constant is prefixed by `#`. The instruction `LD R1, #100` loads the integer `100` into register *R1*, and `ADD R1, R1, #100` adds the integer `100` into register *R1*.

Comments at the end of instructions are preceded by `//`.

Example 8.2: The three-address statement  $x = y - z$  can be implemented by the machine instructions:



```

LD R1, y          // R1 = y
LD R2, z          // R2 = z
SUB R1, R1, R2    // R1 = R1 - R2
ST x, R1          // x = R1

```

We can do better, perhaps. One of the goals of a good code-generation algorithm is to avoid using all four of these instructions, whenever possible. For example,  $y$  and/or  $z$  may have been computed in a register, and if so we can avoid the **LD** step(s). Likewise, we might be able to avoid ever storing  $x$  if its value is used within the register set and is not subsequently needed.

Suppose  $a$  is an array whose elements are 8-byte values, perhaps real numbers. Also assume elements of  $a$  are indexed starting at 0. We may execute the three-address instruction  $b = a[i]$  by the machine instructions:

```

LD R1, i          // R1 = i
MUL R1, R1, 8     // R1 = R1 * 8
LD R2, a(R1)      // R2 = contents(a + contents(R1))
ST b, R2          // b = R2

```

That is, the second step computes  $S_i$ , and the third step places in register **R2** the value in the  $z$ th element of  $a$  — the one found in the location that is  $8i$  bytes past the base address of the array  $a$ .

Similarly, the assignment into the array  $a$  represented by three-address instruction  $a[j] = c$  is implemented by:

```

LD R1, c          // R1 = c
LD R2, j          // R2 = j
MUL R2, R2, 8     // R2 = R2 * 8
ST a(R2), R1      // contents(a + contents(R2)) = R1

```

To implement a simple pointer indirection, such as the three-address statement  $x = *p$ , we can use machine instructions like:

```

LD R1, p          // R1 = p
LD R2, 0(R1)      // R2 = contents(0 + contents(R1))
ST x, R2          // x = R2

```

The assignment through a pointer  $*p = y$  is similarly implemented in machine code by:

```

LD R1, p          // R1 = p
LD R2, y          // R2 = y

ST 0(R1), R2      // contents(0 + contents(R1)) = R2

```

Finally, consider a conditional-jump three-address instruction like

```

if x < y goto L

```

The machine-code equivalent would be something like:

```
LD  R1, x          // R1 = x
LD  R2, y          // R2 = y
SUB R1, R1, R2     // R1 = R1 - R2
BLTZ R1, M         // if R1 < 0 jump to M
```

Here, M is the label that represents the first machine instruction generated from the three-address instruction that has label L. As for any three-address instruction, we hope that we can save some of these machine instructions because the needed operands are already in registers or because the result need never be stored. •

### 8.2.2 Program and Instruction Costs

We often associate a cost with compiling and running a program. Depending on what aspect of a program we are interested in optimizing, some common cost measures are the length of compilation time and the size, running time and power consumption of the target program.

Determining the actual cost of compiling and running a program is a complex problem. Finding an optimal target program for a given source program is an undecidable problem in general, and many of the subproblems involved are NP-hard. As we have indicated, in code generation we must often be content with heuristic techniques that produce good but not necessarily optimal target programs.

For the remainder of this chapter, we shall assume each target-language instruction has an associated cost. For simplicity, we take the cost of an instruction to be one plus the costs associated with the addressing modes of the operands. This cost corresponds to the length in words of the instruction. Addressing modes involving registers have zero additional cost, while those involving a memory location or constant in them have an additional cost of one, because such operands have to be stored in the words following the instruction. Some examples:

- The instruction LD RO, R1 copies the contents of register R1 into register RO. This instruction has a cost of one because no additional memory words are required.
- The instruction LD RO, M loads the contents of memory location M into register RO. The cost is two since the address of memory location M is in the word following the instruction.
- The instruction LD R1, \*100(R2) loads into register R1 the value given by  $contents(contents(100 + contents(K2)))$ . The cost is three because the constant 100 is stored in the word following the instruction.

In this chapter we assume the cost of a target-language program on a given input is the sum of costs of the individual instructions executed when the program is run on that input. Good code-generation algorithms seek to minimize the sum of the costs of the instructions executed by the generated target program on typical inputs. We shall see that in some situations we can actually generate optimal code for expressions on certain classes of register machines.

### 8.2.3 Exercises for Section 8.2

**Exercise 8.2.1:** Generate code for the following three-address statements assuming all variables are stored in memory locations.

- a)  $x = 1$
- b)  $x = a$
- c)  $x = a + 1$
- d)  $x = a + b$
- e) The two statements

$$\begin{aligned} x &= b * c \\ y &= a + x \end{aligned}$$

**Exercise 8.2.2:** Generate code for the following three-address statements assuming  $a$  and  $b$  are arrays whose elements are 4-byte values.

- a) The four-statement sequence

$$\begin{aligned} x &= a[i] \\ y &= b[j] \\ a[i] &= y \\ b[j] &= x \end{aligned}$$

- b) The three-statement sequence

$$\begin{aligned} x &= a[i] \\ y &= b[i] \\ z &= x * y \end{aligned}$$

- c) The three-statement sequence

$$\begin{aligned} x &= a[i] \\ y &= b[x] \\ a[i] &= y \end{aligned}$$

**Exercise 8.2.3:** Generate code for the following three-address sequence assuming that  $p$  and  $q$  are in memory locations:

```

y = *q
q = q + 4
*p = y
p = p + 4

```

**Exercise 8.2.4:** Generate code for the following sequence assuming that  $x$ ,  $y$ , and  $z$  are in memory locations:

```

if x < y goto LI
z = 0
goto L2
LI: z = 1

```

**Exercise 8.2.5:** Generate code for the following sequence assuming that  $n$  is in a memory location:

```

s = 0
i = 0
LI: if i > n goto L2
s = s + i
i = i + 1
goto LI
L2:

```

**Exercise 8.2.6:** Determine the costs of the following instruction sequences:

- a)
 

```

LD RO, y
LD R1, z
ADD RO, RO, R1
ST x, RO

```
- b)
 

```

LD RO, i
MUL RO, RO, 8
LD R1, a(R0)
ST b, R1

```
- c)
 

```

LD RO, c
LD R1, i
MUL R1, R1, 8
ST a(R1), RO

```
- d)
 

```

LD RO, p
LD R1, 0(R0)
ST x, R1

```

```
LD RO, p
LD R1, x
ST 0(R0), R1

f) LD RO, x
LD R1, y
SUB RO, RO, R1
BLTZ *R3, RO
```

### 8.3 Addresses in the Target Code

In this section, we show how names in the IR can be converted into addresses in the target code by looking at code generation for simple procedure calls and returns using static and stack allocation. In Section 7.1, we described how each executing program runs in its own logical address space that was partitioned into four code and data areas:

1. A statically determined area *Code* that holds the executable target code. The size of the target code can be determined at compile time.
2. A statically determined data area *Static* for holding global constants and other data generated by the compiler. The size of the global constants and compiler data can also be determined at compile time.
3. A dynamically managed area *Heap* for holding data objects that are allocated and freed during program execution. The size of the *Heap* cannot be determined at compile time.
4. A dynamically managed area *Stack* for holding activation records as they are created and destroyed during procedure calls and returns. Like the *Heap*, the size of the *Stack* cannot be determined at compile time.

#### 8.3.1 Static Allocation

To illustrate code generation for simplified procedure calls and returns, we shall focus on the following three-address statements:

- `call callee`
- `return`
- `halt`
- action, which is a placeholder for other three-address statements.

The size and layout of activation records are determined by the code generator via the information about names stored in the symbol table. We shall first illustrate how to store the return address in an activation record on a procedure

call and how to return control to it after the procedure call. For convenience, we assume the first location in the activation holds the return address.

Let us first consider the code needed to implement the simplest case, static allocation. Here, a `call callee` statement in the intermediate code can be implemented by a sequence of two target-machine instructions:

```
ST callee. static Area, #here + 20
BR callee. code Area
```

The `ST` instruction saves the return address at the beginning of the activation record for *callee*, and the `BR` transfers control to the target code for the called procedure *callee*. The attribute before *callee. static Area* is a constant that gives the address of the beginning of the activation record for *callee*, and the attribute *callee. code Area* is a constant referring to the address of the first instruction of the called procedure *callee* in the *Code* area of the run-time memory.

The operand *#here+ 20* in the `ST` instruction is the literal return address; it is the address of the instruction following the `BR` instruction. We assume that *#here* is the address of the current instruction and that the three constants plus the two instructions in the calling sequence have a length of 5 words or 20 bytes.

The code for a procedure ends with a return to the calling procedure, except that the first procedure has no caller, so its final instruction is `HALT`, which returns control to the operating system. A `return callee` statement can be implemented by a simple jump instruction

```
BR * callee. static Area
```

which transfers control to the address saved at the beginning of the activation record for *callee*.

**Example 8.3:** Suppose we have the following three-address code:

```

// code for c
action1
call p
action2
halt

// code for p
actions
return
```

Figure 8.4 shows the target program for this three-address code. We use the pseudoinstruction `ACTION` to represent the sequence of machine instructions to execute the statement `action`, which represents three-address code that is not relevant for this discussion. We arbitrarily start the code for procedure `c` at address 100 and for procedure `p` at address 200. We that assume each `ACTION` instruction takes 20 bytes. We further assume that the activation records for these procedures are statically allocated starting at locations 300 and 364, respectively.

The instructions starting at address 100 implement the statements

```
actioni; call p; actiori2; halt
```

of the first procedure *c*. Execution therefore starts with the instruction `ACTIONi` at address 100. The `ST` instruction at address 120 saves the return address 140 in the machine-status field, which is the first word in the activation record of *p*. The `BR` instruction at address 132 transfers control the first instruction in the target code of the called procedure *p*.

```

// code for c
100: ACTIONi           // code for actioni
120: ST 364, #140      // save return address 140 in location 364
132: BR 200           // call p
140: ACTIONj
160: HALT             // return to operating system

// code for p
200: ACTION3
220: BR *364          // return to address saved in location 364

// 300-363 hold activation record for c
300: // return address
304: // local data for c

// 364-451 hold activation record for p
364: // return address
368: // local data for p

```

Figure 8.4: Target code for static allocation

After executing `ACTION3`, the jump instruction at location 220 is executed. Since location 140 was saved at address 364 by the call sequence above, `*364` represents 140 when the `BR` statement at address 220 is executed. Therefore, when procedure *p* terminates, control returns to address 140 and execution of procedure *c* resumes. •

### 8.3.2 Stack Allocation

Static allocation can become stack allocation by using relative addresses for storage in activation records. In stack allocation, however, the position of an activation record for a procedure is not known until run time. This position is usually stored in a register, so words in the activation record can be accessed as offsets from the value in this register. The indexed address mode of our target machine is convenient for this purpose.

Relative addresses in an activation record can be taken as offsets from any known position in the activation record, as we saw in Chapter 7. For conve-

nience, we shall use positive offsets by maintaining in a register **SP** a pointer to the beginning of the activation record on top of the stack. When a procedure call occurs, the calling procedure increments **SP** and transfers control to the called procedure. After control returns to the caller, we decrement **SP**, thereby deallocating the activation record of the called procedure.

The code for the first procedure initializes the stack by setting **SP** to the start of the stack area in memory:

```
LD  SP,      fstackStart      // initialize the stack
code for the first procedure
HALT                                     // terminate execution
```

A procedure call sequence increments **SP**, saves the return address, and transfers control to the called procedure:

```
ADD  SP, SP, #caller.recordSize  // increment stack pointer
ST   *SP, #here + 16             // save return address
BR   callee.   code   Area       // return to caller
```

The operand *t caller.recordSize* represents the size of an activation record, so the **ADD** instruction makes **SP** point to the next activation record. The operand *there +16* in the **ST** instruction is the address of the instruction following **BR**; it is saved in the address pointed to by **SP**.

The return sequence consists of two parts. The called procedure transfers control to the return address using

```
BR  *0(SP)                          // return to caller
```

The reason for using **\*0(SP)** in the **BR** instruction is that we need two levels of indirection: **0(SP)** is the address of the first word in the activation record and **\*0(SP)** is the return address saved there.

The second part of the return sequence is in the caller, which decrements **SP**, thereby restoring **SP** to its previous value. That is, after the subtraction **SP** points to the beginning of the activation record of the caller:

```
SUB  SP, SP, #caller.recordSize    // decrement stack pointer
```

Chapter 7 contains a broader discussion of calling sequences and the trade-offs in the division of labor between the calling and called procedures.

Example 8.4: The program in Fig. 8.5 is an abstraction of the quicksort program in the previous chapter. Procedure *q* is recursive, so more than one activation of *q* can be alive at the same time.

Suppose that the sizes of the activation records for procedures **m**, **p**, and **q** have been determined to be *m*size, *p*size, and *q*size, respectively. The first word in each activation record will hold a return address. We arbitrarily assume that the code for these procedures starts at addresses **100**, **200**, and **300**, respectively,



```

// code for m
actioni
call q
actiori2
halt

// code for p
actions
return

// code for q
action4
call p
actions
call q
actions
call q
return

```

Figure 8.5: Code for Example 8.4

and that the stack starts at address 600. The target program is shown in Figure 8.6.

We assume that ACTION4 contains a conditional jump to the address 456 of the return sequence from q; otherwise, the recursive procedure q is condemned to call itself forever.

If *m*size, *p*size, and *q*size are 20, 40, and 60, respectively, the first instruction at address 100 initializes the SP to 600, the starting address of the stack. SP holds 620 just before control transfers from m to q, because *m*size is 20. Subsequently, when q calls p, the instruction at address 320 increments SP to 680, where the activation record for p begins; SP reverts to 620 after control returns to q. If the next two recursive calls of q return immediately, the maximum value of SP during this execution 680. Note, however, that the last stack location used is 739, since the activation record of q starting at location 680 extends for 60 bytes. •

### 8.3.3 Run-Time Addresses for Names

The storage-allocation strategy and the layout of local data in an activation record for a procedure determine how the storage for names is accessed. In Chapter 6, we assumed that a name in a three-address statement is really a pointer to a symbol-table entry for that name. This approach has a significant advantage; it makes the compiler more portable, since the front end need not be changed even when the compiler is moved to a different machine where a different run-time organization is needed. On the other hand, generating the specific sequence of access steps while generating intermediate code can be of

```

100- LD SP, #600           // code for m
108- ACTIONi             // initialize the stack
128- ADD SP, SP, #msize  // code for actioni
136- ST *SP, #152       // call sequence begins
144- BR 300             // push return address
152- SUB SP, SP, fmsize // call q
160- ACTIONi 2         // restore SP
180- HALT

// code for p
200- ACTION3
220- BR *0(SP)         // return

// code for q
300- ACTION4           // contains a conditional jump to 456
320- ADD SP, SP, ftqsize
328- ST *SP, #344     // push return address
336- BR 200           // call p
344- SUB SP, SP, #qsize
352- ACTION5
372- ADD SP, SP, #qsize
380- BR *SP, #396     // push return address
388- BR 300           // call q
396- SUB SP, SP, ftqsize
404- ACTIONi
424- ADD SP, SP, #qsize
432- ST *SP, #440     // push return address
440- BR 300           // call q
448- SUB SP, SP, #qsize
456- BR *0(SP)       // return

600: // stack starts here

```

Figure 8.6: Target code for stack allocation

significant advantage in an optimizing compiler, since it lets the optimizer take advantage of details it would not see in the simple three-address statement.

In either case, names must eventually be replaced by code to access storage locations. We thus consider some elaborations of the simple three-address copy statement  $x = 0$ . After the declarations in a procedure are processed, suppose the symbol-table entry for  $x$  contains a relative address 12 for  $x$ . For consider the case in which  $x$  is in a statically allocated area beginning at address *static*. Then the actual run-time address of  $x$  is *static* + 12. Although the compiler can eventually determine the value of *static* + 12 at compile time, the position of the static area may not be known when intermediate code to access the name is generated. In that case, it makes sense to generate three-address code to "compute" *static* + 12, with the understanding that this computation will be carried out during the code generation phase, or possibly by the loader, before the program runs. The assignment  $x = 0$  then translates into

```
static[12] = 0
```

If the static area starts at address 100, the target code for this statement is

```
LD 112, #0
```

### 8.3.4 Exercises for Section 8.3

Exercise 8.3.1: Generate code for the following three-address statements assuming stack allocation where register *SP* points to the top of the stack.

```
call p
call q
return
call r
return
return
```

Exercise 8.3.2: Generate code for the following three-address statements assuming stack allocation where register *SP* points to the top of the stack.

- a)  $x = 1$
- b)  $x = a$
- c)  $x = a + 1$
- d)  $x = a + b$
- e) The two statements

Exercise 8.3.3: Generate code for the following three-address statements again assuming stack allocation and assuming  $a$  and  $b$  are arrays whose elements are 4-byte values.

a) The four-statement sequence

```
x = a[i]
y = b[j]
a[i] = y
b[j] = x
```

b) The three-statement sequence

```
x = a[i]
y = b[i]
z = x * y
```

c) The three-statement sequence

```
x = a[i]
y = b[x]
a[i] = y
```

## 8.4 Basic Blocks and Flow Graphs

This section introduces a graph representation of intermediate code that is helpful for discussing code generation even if the graph is not constructed explicitly by a code-generation algorithm. Code generation benefits from context. We can do a better job of register allocation if we know how values are defined and used, as we shall see in Section 8.8. We can do a better job of instruction selection by looking at sequences of three-address statements, as we shall see in Section 8.9.

The representation is constructed as follows:

1. Partition the intermediate code into *basic blocks*, which are maximal sequences of consecutive three-address instructions with the properties that
  - (a) The flow of control can only enter the basic block through the first instruction in the block. That is, there are no jumps into the middle of the block.
  - (b) Control will leave the block without halting or branching, except possibly at the last instruction in the block.
2. The basic blocks become the nodes of a *flow graph*, whose edges indicate which blocks can follow which other blocks.

## The Effect of Interrupts

The notion that control, once it reaches the beginning of a basic block is certain to continue through to the end requires a bit of thought. There are many reasons why an interrupt, not reflected explicitly in the code, could cause control to leave the block, perhaps never to return. For example, an instruction like  $x = y/z$  appears not to affect control flow, but if  $z$  is 0 it could actually cause the program to abort.

We shall not worry about such possibilities. The reason is as follows. The purpose of constructing basic blocks is to optimize the code. Generally, when an interrupt occurs, either it will be handled and control will come back to the instruction that caused the interrupt, as if control had never deviated, or the program will halt with an error. In the latter case, it doesn't matter how we optimized the code, even if we depended on control reaching the end of the basic block, because the program didn't produce its intended result anyway.

Starting in Chapter 9, we discuss transformations on flow graphs that turn the original intermediate code into "optimized" intermediate code from which better target code can be generated. The "optimized" intermediate code is turned into machine code using the code-generation techniques in this chapter.

### 8.4.1 Basic Blocks

Our first job is to partition a sequence of three-address instructions into basic blocks. We begin a new basic block with the first instruction and keep adding instructions until we meet either a jump, a conditional jump, or a label on the following instruction. In the absence of jumps and labels, control proceeds sequentially from one instruction to the next. This idea is formalized in the following algorithm.

Algorithm 8.5 : Partitioning three-address instructions into basic blocks.

**INPUT:** A sequence of three-address instructions.

**OUTPUT:** A list of the basic blocks for that sequence in which each instruction is assigned to exactly one basic block.

**METHOD:** First, we determine those instructions in the intermediate code that are *leaders*, that is, the first instructions in some basic block. The instruction just past the end of the intermediate program is not included as a leader. The rules for finding leaders are:

1. The first three-address instruction in the intermediate code is a leader.

2. Any instruction that is the target of a conditional or unconditional jump is a leader.
3. Any instruction that immediately follows a conditional or unconditional jump is a leader.

Then, for each leader, its basic block consists of itself and all instructions up to but not including the next leader or the end of the intermediate program. •

```

1) i = 1
2) j = 1
3) t1 = 10 * i
4) t2 = t1 * j
5) t3 = 8 * t2
6) t4 = t3 - 88
7) a[t4] = 0.0
8) j = j + 1
9) if j <= 10 goto
10) i = i + 1
11) if i <= 10 goto
12) i = 1
13) t5 = i - 1
14) t6 = 88 * t5
15) a[t6] = 1.0
16) i = i + 1
17) if i <= 10 goto

```

Figure 8.7: Intermediate code to set a 10 x 10 matrix to an identity matrix

Example 8.6: The intermediate code in Fig. 8.7 turns a 10 x 10 matrix *a* into an identity matrix. Although it is not important where this code comes from, it might be the translation of the pseudocode in Fig. 8.8. In generating the intermediate code, we have assumed that the real-valued array elements take 8 bytes each, and that the matrix *a* is stored in row-major form.

```

for i from 1 to 10 do
    for j from 1 to 10 do
        a[i,j] = 0.0;
for i from 1 to 10 do
    a[i, i] = 1.0;

```

Figure 8.8: Source code for Fig. 8.7

First, instruction 1 is a leader by rule (1) of Algorithm 8.5. To find the other leaders, we first need to find the jumps. In this example, there are three jumps, all conditional, at instructions 9, 11, and 17. By rule (2), the targets of these jumps are leaders; they are instructions 3, 2, and 13, respectively. Then, by rule (3), each instruction following a jump is a leader; those are instructions 10 and 12. Note that no instruction follows 17 in this code, but if there were code following, the 18th instruction would also be a leader.

We conclude that the leaders are instructions 1, 2, 3, 10, 12, and 13. The basic block of each leader contains all the instructions from itself until just before the next leader. Thus, the basic block of 1 is just 1, for leader 2 the block is just 2. Leader 3, however, has a basic block consisting of instructions 3 through 9, inclusive. Instruction 10's block is 10 and 11; instruction 12's block is just 12, and instruction 13's block is 13 through 17. •

## 8.4.2 Next-Use Information

Knowing when the value of a variable will be used next is essential for generating good code. If the value of a variable that is currently in a register will never be referenced subsequently, then that register can be assigned to another variable.

The *use* of a name in a three-address statement is defined as follows. Suppose three-address statement  $i$  assigns a value to  $x$ . If statement  $j$  has  $x$  as an operand, and control can flow from statement  $i$  to  $j$  along a path that has no intervening assignments to  $x$ , then we say statement  $j$  *uses* the value of  $x$  computed at statement  $i$ . We further say that  $x$  is *live* at statement  $i$ .

We wish to determine for each three-address statement  $x = y + z$  what the next uses of  $x$ ,  $y$ , and  $z$  are. For the present, we do not concern ourselves with uses outside the basic block containing this three-address statement.

Our algorithm to determine liveness and next-use information makes a backward pass over each basic block. We store the information in the symbol table. We can easily scan a stream of three-address statements to find the ends of basic blocks as in Algorithm 8.5. Since procedures can have arbitrary side effects, we assume for convenience that each procedure call starts a new basic block.

Algorithm 8.7: Determining the liveness and next-use information for each statement in a basic block.

**INPUT:** A basic block  $B$  of three-address statements. We assume that the symbol table initially shows all nontemporary variables in  $B$  as being live on exit.

**OUTPUT:** At each statement  $i: x = y + z$  in  $B$ , we attach to  $i$  the liveness and next-use information of  $x$ ,  $y$ , and  $z$ .

**METHOD:** We start at the last statement in  $B$  and scan backwards to the beginning of  $B$ . At each statement  $i: x = y + z$  in  $B$ , we do the following:

1. Attach to statement  $i$  the information currently found in the symbol table regarding the next use and liveness of  $x$ ,  $y$ , and  $z$ .

2. In the symbol table, set  $x$  to "not live" and "no next use."
3. In the symbol table, set  $y$  and  $z$  to "live" and the next uses of  $y$  and  $z$  to  $i$ .

Here we have used  $+$  as a symbol representing any operator. If the three-address statement  $i$  is of the form  $x = + y$  or  $x = y$ , the steps are the same as above, ignoring  $z$ . Note that the order of steps (2) and (3) may not be interchanged because  $x$  may be  $y$  or  $z$ . •

### 8.4.3 Flow Graphs

Once an intermediate-code program is partitioned into basic blocks, we represent the flow of control between them by a flow graph. The nodes of the flow graph are the basic blocks. There is an edge from block  $B$  to block  $C$  if and only if it is possible for the first instruction in block  $C$  to immediately follow the last instruction in block  $B$ . There are two ways that such an edge could be justified:

- There is a conditional or unconditional jump from the end of  $B$  to the beginning of  $C$ .
- $C$  immediately follows  $B$  in the original order of the three-address instructions, and  $B$  does not end in an unconditional jump.

We say that  $B$  is a *predecessor* of  $C$ , and  $C$  is a *successor* of  $B$ .

Often we add two nodes, called the *entry* and *exit*, that do not correspond to executable intermediate instructions. There is an edge from the entry to the first executable node of the flow graph, that is, to the basic block that comes from the first instruction of the intermediate code. There is an edge to the exit from any basic block that contains an instruction that could be the last executed instruction of the program. If the final instruction of the program is not an unconditional jump, then the block containing the final instruction of the program is one predecessor of the exit, but so is any basic block that has a jump to code that is not part of the program.

**Example 8.8:** The set of basic blocks constructed in Example 8.6 yields the flow graph of Fig. 8.9. The entry points to basic block  $B_1$ , since  $B_1$  contains the first instruction of the program. The only successor of  $B_1$  is  $B_2$ , because  $B_1$  does not end in an unconditional jump, and the leader of  $B_2$  immediately follows the end of  $B_1$ .

Block  $B_2$  has two successors. One is itself, because the leader of  $B_2$ , instruction 3, is the target of the conditional jump at the end of  $\text{£3}$ , instruction 9. The other successor is  $B_4$ , because control can fall through the conditional jump at the end of  $B_2$  and next enter the leader of  $B_4$ .

Only  $B_4$  points to the exit of the flow graph, since the only way to get to code that follows the program from which we constructed the flow graph is to fall through the conditional jump that ends  $B_4$ . •



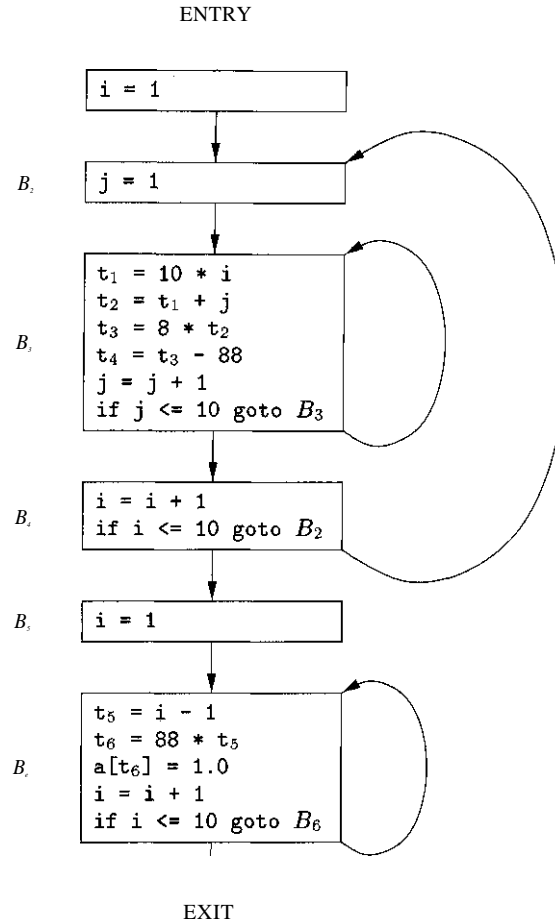

Figure 8.9: Flow graph from Fig. 8.7

#### 8.4.4 Representation of Flow Graphs

First, note from Fig. 8.9 that in the flow graph, it is normal to replace the jumps to instruction numbers or labels by jumps to basic blocks. Recall that every conditional or unconditional jump is to the leader of some basic block, and it is to this block that the jump will now refer. The reason for this change is that after constructing the flow graph, it is common to make substantial changes to the instructions in the various basic blocks. If jumps were to instructions, we would have to fix the targets of the jumps every time one of the target instructions was changed.

Flow graphs, being quite ordinary graphs, can be represented by any of the data structures appropriate for graphs. The content of nodes (basic blocks) need their own representation. We might represent the content of a node by a

pointer to the leader in the array of three-address instructions, together with a count of the number of instructions or a second pointer to the last instruction. However, since we may be changing the number of instructions in a basic block frequently, it is likely to be more efficient to create a linked list of instructions for each basic block.

### 8.4.5 Loops

Programming-language constructs like while-statements, do-while-statements, and for-statements naturally give rise to loops in programs. Since virtually every program spends most of its time in executing its loops, it is especially important for a compiler to generate good code for loops. Many code transformations depend upon the identification of "loops" in a flow graph. We say that a set of nodes  $L$  in a flow graph is a *loop* if

1. There is a node in  $L$  called the *loop entry* with the property that no other node in  $L$  has a predecessor outside  $L$ . That is, every path from the entry of the entire flow graph to any node in  $L$  goes through the loop entry.
2. Every node in  $L$  has a nonempty path, completely within  $L$ , to the entry of  $L$ .

Example 8.9: The flow graph of Fig. 8.9 has three loops:

1.  $B_1$  by itself.
2.  $B_2$  by itself.
3.  $\{B_2, B_3, B_4\}$ .

The first two are single nodes with an edge to the node itself. For instance,  $B_1$  forms a loop with  $B_1$  as its entry. Note that the second requirement for a loop is that there be a nonempty path from  $B_1$  to itself. Thus, a single node like  $B_3$  which does not have an edge  $B_3 \rightarrow B_3$  is not a loop, since there is no nonempty path from  $B_3$  to itself within  $\{B_3\}$ .

The third loop,  $L = \{B_2, B_3, B_4\}$ , has  $B_2$  as its loop entry. Note that among these three nodes, only  $B_2$  has a predecessor,  $B_1$ , that is not in  $L$ . Further, each of the three nodes has a nonempty path to  $B_2$  staying within  $L$ . For instance,  $B_3$  has the path  $B_3 \rightarrow B_4 \rightarrow B_2$ .

### 8.4.6 Exercises for Section 8.4

Exercise 8.4.1: Figure 8.10 is a simple matrix-multiplication program.

- a) Translate the program into three-address statements of the type we have been using in this section. Assume the matrix entries are numbers that require 8 bytes, and that matrices are stored in row-major order.

- b) Construct the flow graph for your code from (a).
- c) Identify the loops in your flow graph from (b).

```

for (i=0; i<n; i++)
    for (j=0; j<n; j++)
        c[i][j] = 0.0;
for (i=0; i<n; i++)
    for (j=0; j<n; j++)
        for (k=0; k<n; k++)
            c[i][j] = c[i][j] + a[i][k]*b[k][j];

```

Figure 8.10: A matrix-multiplication algorithm

**Exercise 8.4.2:** Figure 8.11 is code to count the number of primes from 2 to  $n$ , using the sieve method on a suitably large array  $a$ . That is,  $a[i]$  is **TRUE** at the end only if there is no prime  $V_i$  or less that evenly divides  $i$ . We initialize all  $a[i]$  to **TRUE** and then set  $a[j]$  to **FALSE** if we find a divisor of  $j$ .

- a) Translate the program into three-address statements of the type we have been using in this section. Assume integers require 4 bytes.
- b) Construct the flow graph for your code from (a).
- c) Identify the loops in your flow graph from (b).

```

for (i=2; i<=n; i++)
    a[i] = TRUE;
count = 0;
s = sqrt(n);
for (i=2; i<=s; i++)
    if (a[i]) /* i has been found to be a prime */ {
        count++;
        for (j=2*i; j<=n; j = j+i)
            a[j] = FALSE; /* no multiple of i is a prime */
    }

```

Figure 8.11: Code to sieve for primes

## 8.5 Optimization of Basic Blocks

We can often obtain a substantial improvement in the running time of code merely by performing *local* optimization within each basic block by itself. More thorough *global* optimization, which looks at how information flows among the basic blocks of a program, is covered in later chapters, starting with Chapter 9. It is a complex subject, with many different techniques to consider.

### 8.5.1 The DAG Representation of Basic Blocks

Many important techniques for local optimization begin by transforming a basic block into a DAG (directed acyclic graph). In Section 6.1.1, we introduced the DAG as a representation for single expressions. The idea extends naturally to the collection of expressions that are created within one basic block. We construct a DAG for a basic block as follows:

1. There is a node in the DAG for each of the initial values of the variables appearing in the basic block.
2. There is a node  $N$  associated with each statement  $s$  within the block. The children of  $N$  are those nodes corresponding to statements that are the last definitions, prior to  $s$ , of the operands used by  $s$ .
3. Node  $N$  is labeled by the operator applied at  $s$ , and also attached to  $N$  is the list of variables for which it is the last definition within the block.
4. Certain nodes are designated *output nodes*. These are the nodes whose variables are *live on exit* from the block; that is, their values may be used later, in another block of the flow graph. Calculation of these "live variables" is a matter for global flow analysis, discussed in Section 9.2.5.

The DAG representation of a basic block lets us perform several code-improving transformations on the code represented by the block.

- a) We can eliminate *local common subexpressions*, that is, instructions that compute a value that has already been computed.
- b) We can eliminate *dead code*, that is, instructions that compute a value that is never used.
- c) We can reorder statements that do not depend on one another; such reordering may reduce the time a temporary value needs to be preserved in a register.
- d) We can apply algebraic laws to reorder operands of three-address instructions, and sometimes thereby simplify the computation.

## 8.5.2 Finding Local Common Subexpressions

Common subexpressions can be detected by noticing, as a new node  $M$  is about to be added, whether there is an existing node  $N$  with the same children, in the same order, and with the same operator. If so, TV computes the same value as  $M$  and may be used in its place. This technique was introduced as the "value-number" method of detecting common subexpressions in Section 6.1.1.

Example 8.10: A DAG for the block

$$\begin{aligned} a &= b + c \\ b &= a - d \\ c &= b + c \\ d &= a - d \end{aligned}$$

is shown in Fig. 8.12. When we construct the node for the third statement  $c = b + c$ , we know that the use of  $b$  in  $b + c$  refers to the node of Fig. 8.12 labeled  $-$ , because that is the most recent definition of  $b$ . Thus, we do not confuse the values computed at statements one and three.

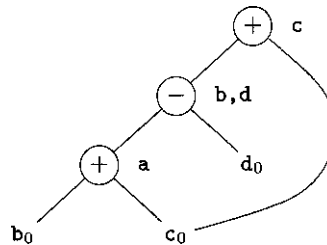

Figure 8.12: DAG for basic block in Example 8.10

However, the node corresponding to the fourth statement  $d = a - d$  has the operator  $-$  and the nodes with attached variables  $a$  and  $d_0$  as children. Since the operator and the children are the same as those for the node corresponding to statement two, we do not create this node, but add  $d$  to the list of definitions for the node labeled  $-$ .

It might appear that, since there are only three nonleaf nodes in the DAG of Fig. 8.12, the basic block in Example 8.10 can be replaced by a block with only three statements. In fact, if  $b$  is not live on exit from the block, then we do not need to compute that variable, and can use  $d$  to receive the value represented by the node labeled  $-$  in Fig. 8.12. The block then becomes

However, if both  $b$  and  $d$  are live on exit, then a fourth statement must be used to copy the value from one to the other.<sup>1</sup>

**Example 8.11:** When we look for common subexpressions, we really are looking for expressions that are guaranteed to compute the same value, no matter how that value is computed. Thus, the DAG method will miss the fact that the expression computed by the first and fourth statements in the sequence

$$\begin{aligned} a &= b + c; \\ b &= b - d \\ c &= c + d \\ e &= b + c \end{aligned}$$

is the same, namely  $b + c$ . That is, even though  $b$  and  $c$  both change between the first and last statements, their sum remains the same, because  $b + c = (b - d) + (c + d)$ . The DAG for this sequence is shown in Fig. 8.13, but does not exhibit any common subexpressions. However, algebraic identities applied to the DAG, as discussed in Section 8.5.4, may expose the equivalence. •

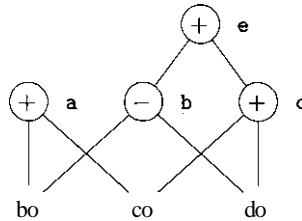

Figure 8.13: DAG for basic block in Example 8.11

### 8.5.3 Dead Code Elimination

The operation on DAG's that corresponds to dead-code elimination can be implemented as follows. We delete from a DAG any root (node with no ancestors) that has no live variables attached. Repeated application of this transformation will remove all nodes from the DAG that correspond to dead code.

**Example 8.12:** If, in Fig. 8.13,  $a$  and  $b$  are live but  $c$  and  $e$  are not, we can immediately remove the root labeled  $e$ . Then, the node labeled  $c$  becomes a root and can be removed. The roots labeled  $a$  and  $b$  remain, since they each have live variables attached. •

<sup>1</sup>In general, we must be careful, when reconstructing code from DAG's, how we choose the names of variables. If a variable  $x$  is defined twice, or if it is assigned once and the initial value  $x_0$  is also used, then we must make sure that we do not change the value of  $x$  until we have made all uses of the node whose value  $x$  previously held.

### 8.5.4 The Use of Algebraic Identities

Algebraic identities represent another important class of optimizations on basic blocks. For example, we may apply arithmetic identities, such as

$$\begin{array}{ll} x + 0 = 0 + x & x - 0 = x \\ xxl = lxx = x & x/1 = x \end{array}$$

to eliminate computations from a basic block.

Another class of algebraic optimizations includes local *reduction in strength*, that is, replacing a more expensive operator by a cheaper one as in:

EXPENSIVE	=	CHEAPER
$x^2$	=	$xxx$
$2\ x\ x$	=	$x + x$
$x/2$	=	$x\ x\ 0.5$

A third class of related optimizations is *constant folding*. Here we evaluate constant expressions at compile time and replace the constant expressions by their values.<sup>2</sup> Thus the expression  $2 * 3.14$  would be replaced by  $6.28$ . Many constant expressions arise in practice because of the frequent use of symbolic constants in programs.

The DAG-construction process can help us apply these and other more general algebraic transformations such as commutativity and associativity. For example, suppose the language reference manual specifies that  $*$  is commutative; that is,  $x*y = y*x$ . Before we create a new node labeled  $*$  with left child  $M$  and right child  $N$ , we always check whether such a node already exists. However, because  $*$  is commutative, we should then check for a node having operator  $*$ , left child  $N$ , and right child  $M$ .

The relational operators such as  $<$  and  $—$  sometimes generate unexpected common subexpressions. For example, the condition  $x > y$  can also be tested by subtracting the arguments and performing a test on the condition code set by the subtraction.<sup>3</sup> Thus, only one node of the DAG may need to be generated for  $x - y$  and  $x > y$ .

Associative laws might also be applicable to expose common subexpressions. For example, if the source code has the assignments

```
a = b + c;
e = c + d + b;
```

the following intermediate code might be generated:

<sup>2</sup> Arithmetic expressions should be evaluated the same way at compile time as they are at run time. K. Thompson has suggested an elegant solution to constant folding: compile the constant expression, execute the target code on the spot, and replace the expression with the result. Thus, the compiler does not need to contain an interpreter.

<sup>3</sup>The subtraction can, however, introduce overflows and underflows while a compare instruction would not.

```

a = b + c
t = c + d
e = t + b

```

If **t** is not needed outside this block, we can change this sequence to

```

a = b + c
e = a + d

```

using both the associativity and commutativity of +.

The compiler writer should examine the language reference manual carefully to determine what rearrangements of computations are permitted, since (because of possible overflows or underflows) computer arithmetic does not always obey the algebraic identities of mathematics. For example, the Fortran standard states that a compiler may evaluate any mathematically equivalent expression, provided that the integrity of parentheses is not violated. Thus, a compiler may evaluate  $x * y - x * z$  as  $x * (y - z)$ , but it may not evaluate  $a + (b - c)$  as  $(a + b) - c$ . A Fortran compiler must therefore keep track of where parentheses were present in the source language expressions if it is to optimize programs in accordance with the language definition.

### 8.5.5 Representation of Array References

At first glance, it might appear that the array-indexing instructions can be treated like any other operator. Consider for instance the sequence of three-address statements:

```

x = a[i]
a[j] = y
z = a[i]

```

If we think of **a**[**i**] as an operation involving **a** and **i**, similar to  $a + i$ , then it might appear as if the two uses of **a**[**i**] were a common subexpression. In that case, we might be tempted to "optimize" by replacing the third instruction **z** = **a**[**i**] by the simpler **z** = **x**. However, since **j** could equal **i**, the middle statement may in fact change the value of **a**[**i**]; thus, it is not legal to make this change.

The proper way to represent array accesses in a DAG is as follows.

1. An assignment from an array, like **x** = **a**[**i**], is represented by creating a node with operator [=] and two children representing the initial value of the array, **a**, in this case, and the index **i**. Variable **x** becomes a label of this new node.
2. An assignment to an array, like **a**[**j**] = **y**, is represented by a new node with operator []= and three children representing **a**, **j** and **y**. There is no variable labeling this node. What is different is that the creation of



this node *kills* all currently constructed nodes whose value depends on  $a_0$ . A node that has been killed cannot receive any more labels; that is, it cannot become a common subexpression.

**Example 8.13:** The DAG for the basic block

$$\begin{aligned} x &= a[i] \\ a[j] &= y \\ z &= a[i] \end{aligned}$$

is shown in Fig- 8.14. The node  $N$  for  $x$  is created first, but when the node labeled  $[\ ]=$  is created,  $N$  is killed. Thus, when the node for  $z$  is created, it cannot be identified with  $N$ , and a new node with the same operands  $a_0$  and  $i_0$  must be created instead. •

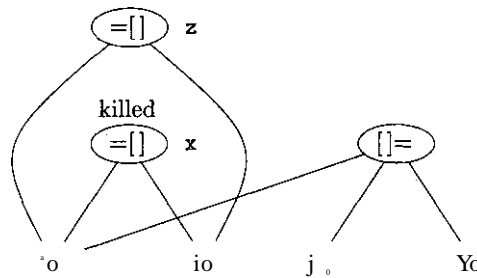

Figure 8.14: The DAG for a sequence of array assignments

**Example 8.14:** Sometimes, a node must be killed even though none of its children have an array like  $a$ , in Example 8.13 as attached variable. Likewise, a node can kill if it has a descendant that is an array, even though none of its children are array nodes. For instance, consider the three-address code

$$\begin{aligned} b &= 12 + a \\ x &= b[i] \\ b[j] &= y \end{aligned}$$

What is happening here is that, for efficiency reasons,  $b$  has been defined to be a position in an array  $a$ . For example, if the elements of  $a$  are four bytes long, then  $b$  represents the fourth element of  $a$ . If  $j$  and  $i$  represent the same value, then  $b[i]$  and  $b[j]$  represent the same location. Therefore it is important to have the third instruction,  $b[j] = y$ , kill the node with  $x$  as its attached variable. However, as we see in Fig. 8.15, both the killed node and the node that does the killing have  $c_0$  as a grandchild, not as a child. •

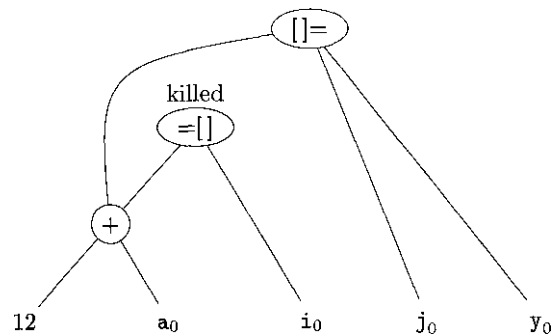

Figure 8.15: A node that kills a use of an array need not have that array as a child

### 8.5.6 Pointer Assignments and Procedure Calls

When we assign indirectly through a pointer, as in the assignments

$$\begin{aligned} x &= *p \\ *q &= y \end{aligned}$$

we do not know what  $p$  or  $q$  point to. In effect,  $x = *p$  is a use of every variable whatsoever, and  $*q = y$  is a possible assignment to every variable. As a consequence, the operator  $=*$  must take all nodes that are currently associated with identifiers as arguments, which is relevant for dead-code elimination. More importantly, the  $=*$  operator kills all other nodes so far constructed in the DAG.

There are global pointer analyses one could perform that might limit the set of variables a pointer could reference at a given place in the code. Even local analysis could restrict the scope of a pointer. For instance, in the sequence

$$\begin{aligned} p &= \&x \\ *p &= y \end{aligned}$$

we know that  $x$ , and no other variable, is given the value of  $y$ , so we don't need to kill any node but the node to which  $x$  was attached.

Procedure calls behave much like assignments through pointers. In the absence of global data-flow information, we must assume that a procedure uses and changes any data to which it has access. Thus, if variable  $x$  is in the scope of a procedure  $P$ , a call to  $P$  both uses the node with attached variable  $x$  and kills that node.

### 8.5.7 Reassembling Basic Blocks From DAG's

After we perform whatever optimizations are possible while constructing the DAG or by manipulating the DAG once constructed, we may reconstitute the three-address code for the basic block from which we built the DAG. For each

node that has one or more attached variables, we construct a three-address statement that computes the value of one of those variables. We prefer to compute the result into a variable that is live on exit from the block. However, if we do not have global live-variable information to work from, we need to assume that every variable of the program (but not temporaries that are generated by the compiler to process expressions) is live on exit from the block.

If the node has more than one live variable attached, then we have to introduce copy statements to give the correct value to each of those variables. Sometimes, global optimization can eliminate those copies, if we can arrange to use one of two variables in place of the other.

**Example 8.15:** Recall the DAG of Fig. 8.12. In the discussion following Example 8.10, we decided that if  $b$  is not live on exit from the block, then the three statements

$$\begin{aligned} a &= b + c \\ d &= a - d \\ c &= d + c \end{aligned}$$

suffice to reconstruct the basic block. The third instruction,  $c = d + c$ , must use  $d$  as an operand rather than  $b$ , because the optimized block never computes  $b$ .

If both  $b$  and  $d$  are live on exit, or if we are not sure whether or not they are live on exit, then we need to compute  $b$  as well as  $d$ . We can do so with the sequence

$$\begin{aligned} a &= b + c \\ d &= a - d \\ b &= d \\ c &= d + c \end{aligned}$$

This basic block is still more efficient than the original. Although the number of instructions is the same, we have replaced a subtraction by a copy, which tends to be less expensive on most machines. Further, it may be that by doing a global analysis, we can eliminate the use of this computation of  $b$  outside the block by replacing it by uses of  $d$ . In that case, we can come back to this basic block and eliminate  $b = d$  later. Intuitively, we can eliminate this copy if wherever this value of  $b$  is used,  $d$  is still holding the same value. That situation may or may not be true, depending on how the program recomputes  $d$ . •

When reconstructing the basic block from a DAG, we not only need to worry about what variables are used to hold the values of the DAG's nodes, but we also need to worry about the order in which we list the instructions computing the values of the various nodes. The rules to remember are

1. The order of instructions must respect the order of nodes in the DAG. That is, we cannot compute a node's value until we have computed a value for each of its children.

2. Assignments to an array must follow all previous assignments to, or evaluations from, the same array, according to the order of these instructions in the original basic block.
3. Evaluations of array elements must follow any previous (according to the original block) assignments to the same array. The only permutation allowed is that two evaluations from the same array may be done in either order, as long as neither crosses over an assignment to that array.
4. Any use of a variable must follow all previous (according to the original block) procedure calls or indirect assignments through a pointer.
5. Any procedure call or indirect assignment through a pointer must follow all previous (according to the original block) evaluations of any variable.

That is, when reordering code, no statement may cross a procedure call or assignment through a pointer, and uses of the same array may cross each other only if both are array accesses, but not assignments to elements of the array.

### 8.5.8 Exercises for Section 8.5

**Exercise 8.5.1:** Construct the DAG for the basic block

$$\begin{aligned} d &= b * c \\ e &= a + b \\ b &= b * c \\ a &= e - d \end{aligned}$$

**Exercise 8.5.2:** Simplify the three-address code of Exercise 8.5.1, assuming

- a) Only  $a$  is live on exit from the block.
- b)  $a$ ,  $b$ , and  $c$  are live on exit from the block.

**Exercise 8.5.3:** Construct the basic block for the code in block  $B_6$  of Fig. 8.9. Do not forget to include the comparison  $i < 10$ .

**Exercise 8.5.4:** Construct the basic block for the code in block  $B_7$  of Fig. 8.9.

**Exercise 8.5.5:** Extend Algorithm 8.7 to process three-statements of the form

- a)  $a[i] = b$
- b)  $a = b[i]$
- c)  $a = *b$
- c)  $*a = b$

**Exercise 8.5.6:** Construct the DAG for the basic block

```

a[i] = b
*p = c
d = a[j]
e = *p
*p = a[i]

```

on the assumption that

- a)  $p$  can point anywhere.
- b)  $p$  can point only to  $b$  or  $d$ .

Exercise 8.5.7: If a pointer or array expression, such as  $a[i]$  or  $*p$  is assigned and then used, without the possibility of being changed in the interim, we can take advantage of the situation to simplify the DAG. For example, in the code of Exercise 8.5.6, since  $p$  is not assigned between the second and fourth statements, the statement  $e = *p$  can be replaced by  $e = c$ , regardless of what  $p$  points to. Revise the DAG-construction algorithm to take advantage of such situations, and apply your algorithm to the code of Example 8.5.6.

Exercise 8.5.8: Suppose a basic block is formed from the C assignment statements

```

x = a + b + c + d + e + f;
y = a + c + e;

```

- a) Give the three-address statements (only one addition per statement) for this block.
- b) Use the associative and commutative laws to modify the block to use the fewest possible number of instructions, assuming both  $x$  and  $y$  are live on exit from the block.

## 8.6 A Simple Code Generator

In this section, we shall consider an algorithm that generates code for a single basic block. It considers each three-address instruction in turn, and keeps track of what values are in what registers so it can avoid generating unnecessary loads and stores.

One of the primary issues during code generation is deciding how to use registers to best advantage. There are four principal uses of registers:

- In most machine architectures, some or all of the operands of an operation must be in registers in order to perform the operation.
- Registers make good temporaries — places to hold the result of a subexpression while a larger expression is being evaluated, or more generally, a place to hold a variable that is used only within a single basic block.

- Registers are used to hold (*global*) values that are computed in one basic block and used in other blocks, for example, a loop index that is incremented going around the loop and is used several times within the loop.
- Registers are often used to help with run-time storage management, for example, to manage the run-time stack, including the maintenance of stack pointers and possibly the top elements of the stack itself.

These are competing needs, since the number of registers available is limited.

The algorithm in this section assumes that some set of registers is available to hold the values that are used within the block. Typically, this set of registers does not include all the registers of the machine, since some registers are reserved for global variables and managing the stack. We assume that the basic block has already been transformed into a preferred sequence of three-address instructions, by transformations such as combining common subexpressions. We further assume that for each operator, there is exactly one machine instruction that takes the necessary operands in registers and performs that operation, leaving the result in a register. The machine instructions are of the form

- **LD** *reg, mem*
- **ST** *mem, reg*
- **OP** *reg, reg, reg*

### 8.6.1 Register and Address Descriptors

Our code-generation algorithm considers each three-address instruction in turn and decides what loads are necessary to get the needed operands into registers. After generating the loads, it generates the operation itself. Then, if there is a need to store the result into a memory location, it also generates that store.

In order to make the needed decisions, we require a data structure that tells us what program variables currently have their value in a register, and which register or registers, if so. We also need to know whether the memory location for a given variable currently has the proper value for that variable, since a new value for the variable may have been computed in a register and not yet stored. The desired data structure has the following descriptors:

1. For each available register, a *register descriptor* keeps track of the variable names whose current value is in that register. Since we shall use only those registers that are available for local use within a basic block, we assume that initially, all register descriptors are empty. As the code generation progresses, each register will hold the value of zero or more names.
2. For each program variable, an *address descriptor* keeps track of the location or locations where the current value of that variable can be found. The location might be a register, a memory address, a stack location, or some set of more than one of these. The information can be stored in the symbol-table entry for that variable name.

### 8.6.2 The Code-Generation Algorithm

An essential part of the algorithm is a function *getReg(I)*, which selects registers for each memory location associated with the three-address instruction *I*. Function *getReg* has access to the register and address descriptors for all the variables of the basic block, and may also have access to certain useful data-flow information such as the variables that are live on exit from the block. We shall discuss *getReg* after presenting the basic algorithm. While we do not know the total number of registers available for local data belonging to a basic block, we assume that there are enough registers so that, after freeing all available registers by storing their values in memory<sup>^</sup> there are enough registers to accomplish any three-address operation.

In a three-address instruction such as  $x = y + z$ , we shall treat  $+$  as a generic operator and **ADD** as the equivalent machine instruction. We do not, therefore, take advantage of commutativity of  $+$ . Thus, when we implement the operation, the value of  $y$  must be in the second register mentioned in the **ADD** instruction, never the third. A possible improvement to the algorithm is to generate code for both  $x = y + z$  and  $x = z + y$  whenever  $+$  is a commutative operator, and pick the better code sequence.

#### Machine Instructions for Operations

For a three-address instruction such as  $x = y + z$ , do the following:

1. Use *getReg(x = y + z)* to select registers for  $x$ ,  $y$ , and  $z$ . Call these  $R_x$ ,  $R_y$ , and  $R_z$ .
2. If  $y$  is not in  $R_x$  (according to the register descriptor for  $R_x$ ), then issue an instruction **LD**  $R_x, y'$ , where  $y'$  is one of the memory locations for  $y$  (according to the address descriptor for  $y$ ).
3. Similarly, if  $z$  is not in  $R_x$ , issue an instruction **LD**  $R_x, z'$ , where  $z'$  is a location for  $z$ .
4. Issue the instruction **ADD**  $R_x, R_y, R_z$ .

#### Machine Instructions for Copy Statements

There is an important special case: a three-address copy statement of the form  $x = y$ . We assume that *getReg* will always choose the same register for both  $x$  and  $y$ . If  $y$  is not already in that register  $R_x$ , then generate the machine instruction **LD**  $R_x, y$ . If  $y$  was already in  $R_x$ , we do nothing. It is only necessary that we adjust the register description for  $R_x$  so that it includes  $x$  as one of the values found there.

### Ending the Basic Block

As we have described the algorithm, variables used by the block may wind up with their only location being a register. If the variable is a temporary used only within the block, that is fine; when the block ends, we can forget about the value of the temporary and assume its register is empty. However, if the variable is live on exit from the block, or if we don't know which variables are live on exit, then we need to assume that the value of the variable is needed later. In that case, for each variable  $x$  whose location descriptor does not say that its value is located in the memory location for  $x$ , we must generate the instruction **ST**  $x, R$ , where  $R$  is a register in which  $x$ 's value exists at the end of the block.

### Managing Register and Address Descriptors

As the code-generation algorithm issues load, store, and other machine instructions, it needs to update the register and address descriptors. The rules are as follows:

1. For the instruction **LD**  $R, x$ 
  - (a) Change the register descriptor for register  $R$  so it holds only  $x$ .
  - (b) Change the address descriptor for  $x$  by adding register  $R$  as an additional location.
2. For the instruction **ST**  $x, R$ , change the address descriptor for  $x$  to include its own memory location.
3. For an operation such as **ADD**  $R_i, R_j, R_k$  implementing a three-address instruction  $x = y + z$ 
  - (a) Change the register descriptor for  $R_i$  so that it holds only  $x$ .
  - (b) Change the address descriptor for  $x$  so that its only location is  $R_i$ . Note that the memory location for  $x$  is *not* now in the address descriptor for  $x$ .
  - (c) Remove  $R_i$  from the address descriptor of any variable other than  $x$ .
4. When we process a copy statement  $x = y$ , after generating the load for  $y$  into register  $R_j$ , if needed, and after managing descriptors as for all load statements (per rule 1):
  - (a) Add  $x$  to the register descriptor for  $R_j$ .
  - (b) Change the address descriptor for  $x$  so that its only location is  $R_j$ .

**Example 8.16** : Let us translate the basic block consisting of the three-address statements



```

t = a - b
u = a - c
v = t + u
a = d
d = v + u

```

Here we assume that **t**, **u**, and **v** are temporaries, local to the block, while **a**, **b**, **c**, and **d** are variables that are live on exit from the block. Since we have not yet discussed how the function *getReg* might work, we shall simply assume that there are as many registers as we need, but that when a register's value is no longer needed (for example, it holds only a temporary, all of whose uses have been passed), then we reuse its register.

A summary of all the machine-code instructions generated is in Fig. 8.16. The figure also shows the register and address descriptors before and after the translation of each three-address instruction.

	R1	R2	R3	a	b	c	d	t	u	v
t = a - b										
LD R1, a				a						
LD R2, b					b					
SUB R2, R1, R2										
u = a - c				a	t					
LD R3, c						c				
SUB R1, R1, R3										
v = t + u				u	t	c				
ADD R3, R2, R1										
a = d				U	t	V				
LD R2, d							d			
d = v + u				u	a, d	v				
ADD R1, R3, R1										
exit				d	a	v				
ST a, R2										
St d, R1										
				d	a	v				
					<u>a,R2</u>	<u>b</u>			<u>c</u>	<u>d,R1</u>
										R3

Figure 8.16: Instructions generated and the changes in the register and address descriptors

For the first three-address instruction, **t = a - b** we need to issue three instructions, since nothing is in a register initially. Thus, we see **a** and **b** loaded

into registers **R1** and **R2**, and the value **t** produced in register **R2**. Notice that we can use **R2** for **t** because the value **b** previously in **R2** is not needed within the block. Since **b** is presumably live on exit from the block, had it not been in its own memory location (as indicated by its address descriptor), we would have had to store **R2** into **b** first. The decision to do so, had we needed **R2**, would be taken by *getReg*.

The second instruction,  $u = \mathbf{a} - c$ , does not require a load of **a**, since it is already in register **R1**. Further, we can reuse **R1** for the result, **u**, since the value of **a**, previously in that register, is no longer needed within the block, and its value is in its own memory location if **a** is needed outside the block. Note that we change the address descriptor for **a** to indicate that it is no longer in **R1**, but is in the memory location called **a**.

The third instruction,  $v = \mathbf{t} + u$ , requires only the addition. Further, we can use **R3** for the result, **v**, since the value of **c** in that register is no longer needed within the block, and **c** has its value in its own memory location.

The copy instruction,  $\mathbf{a} = d$ , requires a load of **d**, since it is not in memory. We show register **R2**'s descriptor holding both **a** and **d**. The addition of **a** to the register descriptor is the result of our processing the copy statement, and is not the result of any machine instruction.

The fifth instruction,  $d = v + u$ , uses two values that are in registers. Since **u** is a temporary whose value is no longer needed, we have chosen to reuse its register **R1** for the new value of **d**. Notice that **d** is now in only **R1**, and is not in its own memory location. The same holds for **a**, which is in **R2** and not in the memory location called **a**. As a result, we need a "coda" to the machine code for the basic block that stores the live-on-exit variables **a** and **d** into their memory locations. We show these as the last two instructions. •

### 8.6.3 Design of the Function *getReg*

Lastly, let us consider how to implement *getReg(I)*, for a three-address instruction *I*. There are many options, although there are also some absolute prohibitions against choices that lead to incorrect code due to the loss of the value of one or more live variables. We begin our examination with the case of an operation step, for which we again use  $x = y + z$  as the generic example. First, we must pick a register for **y** and a register for **z**. The issues are the same, so we shall concentrate on picking register **R**, for **y**. The rules are as follows:

1. If **z** is currently in a register, pick a register already containing **y** as **R**. Do not issue a machine instruction to load this register, as none is needed.
2. If **y** is not in a register, but there is a register that is currently empty, pick one such register as **R**.
3. The difficult case occurs when **y** is not in a register, and there is no register that is currently empty. We need to pick one of the allowable registers anyway, and we need to make it safe to reuse. Let **R** be a candidate

register, and suppose  $v$  is one of the variables that the register descriptor for  $R$  says is in  $R$ . We need to make sure that  $u$ 's value either is not really needed, or that there is somewhere else we can go to get the value of  $R$ . The possibilities are:

- (a) If the address descriptor for  $v$  says that  $v$  is somewhere besides  $R$ , then we are OK.
- (b) If  $v$  is  $x$ , the value being computed by instruction  $I$ , and  $x$  is not also one of the other operands of instruction  $I$  ( $z$  in this example), then we are OK. The reason is that in this case, we know this value of  $x$  is never again going to be used, so we are free to ignore it.
- (c) Otherwise, if  $v$  is not used later (that is, after the instruction  $I$ , there are no further uses of  $v$ , and if  $v$  is live on exit from the block, then  $v$  is recomputed within the block), then we are OK.
- (d) If we are not OK by one of the first two cases, then we need to generate the store instruction  $ST\ v, R$  to place a copy of  $v$  in its own memory location. This operation is called a *spill*.

Since  $R$  may hold several variables at the moment, we repeat the above steps for each such variable  $v$ . At the end,  $R$ 's "score" is the number of store instructions we needed to generate. Pick one of the registers with the lowest score.

Now, consider the selection of the register  $R$ . The issues and options are almost as for  $y$ , so we shall only mention the differences.

1. Since a new value of  $x$  is being computed, a register that holds only  $x$  is always an acceptable choice for  $R$ . This statement holds even if  $x$  is one of  $y$  and  $z$ , since our machine instructions allows two registers to be the same in one instruction.
2. If  $y$  is not used after instruction  $I$ , in the sense described for variable  $v$  in item (3c), and  $R$  holds only  $y$  after being loaded, if necessary, then  $R$  can also be used as  $R$ . A similar option holds regarding  $z$  and  $R$ .

The last matter to consider specially is the case when  $I$  is a copy instruction  $x = y$ . We pick the register  $R$  as above. Then, we always choose  $R = R$ .

### 8.6.4 Exercises for Section 8.6

Exercise 8.6.1: For each of the following C assignment statements

- a) `x = a + b*c;`
- b) `x = a/(b+c) - d*(e+f);`
- c) `x = a[i] + 1;`

- d) `a[i] = b[c[i]];`
- e) `a[i][j] = b[i][k] + c[k][j];`
- f) `*p++ = *q++;`

generate three-address code, assuming that all array elements are integers taking four bytes each. In parts (d) and (e), assume that `a`, `b`, and `c` are constants giving the location of the first (0th) elements of the arrays with those names, as in all previous examples of array accesses in this chapter.

**Exercise 8.6.2:** Repeat Exercise 8.6.1 parts (d) and (e), assuming that the arrays `a`, `b`, and `c` are located via pointers, `pa`, `pb`, and `pc`, respectively, pointing to the locations of their respective first elements.

**Exercise 8.6.3:** Convert your three-address code from Exercise 8.6.1 into machine code for the machine model of this section. You may use as many registers as you need.

**Exercise 8.6.4:** Convert your three-address code from Exercise 8.6.1 into machine code, using the simple code-generation algorithm of this section, assuming three registers are available. Show the register and address descriptors after each step.

**Exercise 8.6.5:** Repeat Exercise 8.6.4, but assuming only two registers are available.

## 8.7 Peephole Optimization

While most production compilers produce good code through careful instruction selection and register allocation, a few use an alternative strategy: they generate naive code and then improve the quality of the target code by applying "optimizing" transformations to the target program. The term "optimizing" is somewhat misleading because there is no guarantee that the resulting code is optimal under any mathematical measure. Nevertheless, many simple transformations can significantly improve the running time or space requirement of the target program.

A simple but effective technique for locally improving the target code is *peephole optimization*, which is done by examining a sliding window of target instructions (called the *peephole*) and replacing instruction sequences within the peephole by a shorter or faster sequence, whenever possible. Peephole optimization can also be applied directly after intermediate code generation to improve the intermediate representation.

The peephole is a small, sliding window on a program. The code in the peephole need not be contiguous, although some implementations do require this. It is characteristic of peephole optimization that each improvement may

spawn opportunities for additional improvements. In general, repeated passes over the target code are necessary to get the maximum benefit. In this section, we shall give the following examples of program transformations that are characteristic of peephole optimizations:

- Redundant-instruction elimination
- Flow-of-control optimizations
- Algebraic simplifications
- Use of machine idioms

### 8.7.1 Eliminating Redundant Loads and Stores

If we see the instruction sequence

```
LD a, RO
ST RO, a
```

in a target program, we can delete the store instruction because whenever it is executed, the first instruction will ensure that the value of **a** has already been loaded into register **RO**. Note that if the store instruction had a label, we could not be sure that the first instruction is always executed before the second, so we could not remove the store instruction. Put another way, the two instructions have to be in the same basic block for this transformation to be safe.

Redundant loads and stores of this nature would not be generated by the simple code generation algorithm of the previous section. However, a naive code generation algorithm like the one in Section 8.1.3 would generate redundant sequences such as these.

### 8.7.2 Eliminating Unreachable Code

Another opportunity for peephole optimization is the removal of unreachable instructions. An unlabeled instruction immediately following an unconditional jump may be removed. This operation can be repeated to eliminate a sequence of instructions. For example, for debugging purposes, a large program may have within it certain code fragments that are executed only if a variable **debug** is equal to 1. In the intermediate representation, this code may look like

```
    if debug == 1 goto LI
    goto L2
LI:  print debugging information
L2:
```

One obvious peephole optimization is to eliminate jumps over jumps. Thus, no matter what the value of **debug**, the code sequence above can be replaced by

```

    if debug != 1 goto L2
    print debugging information
L2:

```

If `debug` is set to 0 at the beginning of the program, constant propagation would transform this sequence into

```

    if 0 != 1 goto L2
    print debugging information
L2:

```

Now the argument of the first statement always evaluates to *true*, so the statement can be replaced by `goto L2`. Then all statements that print debugging information are unreachable and can be eliminated one at a time.

### 8.7.3 Flow-of-Control Optimizations

Simple intermediate code-generation algorithms frequently produce jumps to jumps, jumps to conditional jumps, or conditional jumps to jumps. These unnecessary jumps can be eliminated in either the intermediate code or the target code by the following types of peephole optimizations. We can replace the sequence

```

    goto L1

L1: goto L2

```

by the sequence

```

    goto L2

L1: goto L2

```

If there are now no jumps to `L1`, then it may be possible to eliminate the statement `L1: goto L2` provided it is preceded by an unconditional jump.

Similarly, the sequence

```

    if a < b goto L1

L1: goto L2

```

Can be replaced by the sequence

```

    if a < b goto L2

L1: goto L2

```

Finally, suppose there is only one jump to `L1` and `L1` is preceded by an unconditional goto. Then the sequence

```
goto LI
```

```
LI: if a < b goto L2
L3:
```

may be replaced by the sequence

```
if a < b goto L2
goto L3
```

```
L3:
```

While the number of instructions in the two sequences is the same, we sometimes skip the unconditional jump in the second sequence, but never in the first. Thus, the second sequence is superior to the first in execution time,

### 8.7.4 Algebraic Simplification and Reduction in Strength

In Section 8.5 we discussed algebraic identities that could be used to simplify DAG's. These algebraic identities can also be used by a peephole optimizer to eliminate three-address statements such as

$$x = x + 0$$

or

$$x = x * 1$$

in the peephole.

Similarly, reduction-in-strength transformations can be applied in the peephole to replace expensive operations by equivalent cheaper ones on the target machine. Certain machine instructions are considerably cheaper than others and can often be used as special cases of more expensive operators. For example,  $x^2$  is invariably cheaper to implement as  $x * x$  than as a call to an exponentiation routine. Fixed-point multiplication or division by a power of two is cheaper to implement as a shift. Floating-point division by a constant can be approximated as multiplication by a constant, which may be cheaper.

### 8.7.5 Use of Machine Idioms

The target machine may have hardware instructions to implement certain specific operations efficiently. Detecting situations that permit the use of these instructions can reduce execution time significantly. For example, some machines have auto-increment and auto-decrement addressing modes. These add or subtract one from an operand before or after using its value. The use of the modes greatly improves the quality of code when pushing or popping a stack, as in parameter passing. These modes can also be used in code for statements like  $x = x + 1$ .

### 8.7.6 Exercises for Section 8.7

**Exercise 8.7.1:** Construct an algorithm that will perform redundant-instruction elimination in a sliding peephole on target machine code.

**Exercise 8.7.2:** Construct an algorithm that will do flow-of-control optimizations in a sliding peephole on target machine code.

**Exercise 8.7.3:** Construct an algorithm that will do simple algebraic simplifications and reductions in strength in a sliding peephole on target machine code.

## 8.8 Register Allocation and Assignment

Instructions involving only register operands are faster than those involving memory operands. On modern machines, processor speeds are often an order of magnitude or more faster than memory speeds. Therefore, efficient utilization of registers is vitally important in generating good code. This section presents various strategies for deciding at each point in a program what values should reside in registers (register allocation) and in which register each value should reside (register assignment).

One approach to register allocation and assignment is to assign specific values in the target program to certain registers. For example, we could decide to assign base addresses to one group of registers, arithmetic computations to another, the top of the stack to a fixed register, and so on.

This approach has the advantage that it simplifies the design of a code generator. Its disadvantage is that, applied too strictly, it uses registers inefficiently; certain registers may go unused over substantial portions of code, while unnecessary loads and stores are generated into the other registers. Nevertheless, it is reasonable in most computing environments to reserve a few registers for base registers, stack pointers, and the like, and to allow the remaining registers to be used by the code generator as it sees fit.

### 8.8.1 Global Register Allocation

The code generation algorithm in Section 8.6 used registers to hold values for the duration of a single basic block. However, all live variables were stored at the end of each block. To save some of these stores and corresponding loads, we might arrange to assign registers to frequently used variables and keep these registers consistent across block boundaries (*globally*). Since programs spend most of their time in inner loops, a natural approach to global register assignment is to try to keep a frequently used value in a fixed register throughout a loop. For the time being, assume that we know the loop structure of a flow graph, and that we know what values computed in a basic block are used outside that block. The next chapter covers techniques for computing this information.



One strategy for global register allocation is to assign some fixed number of registers to hold the most active values in each inner loop. The selected values may be different in different loops. Registers not already allocated may be used to hold values local to one block as in Section 8.6. This approach has the drawback that the fixed number of registers is not always the right number to make available for global register allocation. Yet the method is simple to implement and was used in Fortran H, the optimizing Fortran compiler developed by IBM for the 360-series machines in the late 1960s.

With early C compilers, a programmer could do some register allocation explicitly by using register declarations to keep certain values in registers for the duration of a procedure. Judicious use of register declarations did speed up many programs, but programmers were encouraged to first profile their programs to determine the program's hotspots before doing their own register allocation.

### 8.8.2 Usage Counts

In this section we shall assume that the savings to be realized by keeping a variable  $x$  in a register for the duration of a loop  $L$  is one unit of cost for each reference to  $x$  if  $x$  is already in a register. However, if we use the approach in Section 8.6 to generate code for a block, there is a good chance that after  $x$  has been computed in a block it will remain in a register if there are subsequent uses of  $x$  in that block. Thus we count a savings of one for each use of  $x$  in loop  $L$  that is not preceded by an assignment to  $x$  in the same block. We also save two units if we can avoid a store of  $x$  at the end of a block. Thus, if  $x$  is allocated a register, we count a savings of two for each block in loop  $L$  for which  $x$  is live on exit and in which  $x$  is assigned a value.

On the debit side, if  $x$  is live on entry to the loop header, we must load  $x$  into its register just before entering loop  $L$ . This load costs two units. Similarly, for each exit block  $B$  of loop  $L$  at which  $x$  is live on entry to some successor of  $B$  outside of  $L$ , we must store  $x$  at a cost of two. However, on the assumption that the loop is iterated many times, we may neglect these debits since they occur only once each time we enter the loop. Thus, an approximate formula for the benefit to be realized from allocating a register  $x$  within loop  $L$  is

$$\sum_{\text{blocks } B \text{ in } L} use(x, B) + 2 * live(x, B) \quad (8.1)$$

where  $use(x, B)$  is the number of times  $x$  is used in  $B$  prior to any definition of  $x$ ;  $live(x, B)$  is 1 if  $x$  is live on exit from  $B$  and is assigned a value in  $B$ , and  $live(x, B)$  is 0 otherwise. Note that (8.1) is approximate, because not all blocks in a loop are executed with equal frequency and also because (8.1) is based on the assumption that a loop is iterated many times. On specific machines a formula analogous to (8.1), but possibly quite different from it, would have to be developed.

Example 8.17: Consider the the basic blocks in the inner loop depicted in Fig. 8.17, where jump and conditional jump statements have been omitted. Assume registers  $R_0$ ,  $R_1$ , and  $R_2$  are allocated to hold values throughout the loop. Variables live on entry into and on exit from each block are shown in Fig. 8.17 for convenience, immediately above and below each block, respectively. There are some subtle points about live variables that we address in the next chapter. For example, notice that both  $e$  and  $f$  are live at the end of  $B_1$ , but of these, only  $e$  is live on entry to  $B_2$  and only  $f$  on entry to  $B_3$ . In general, the variables live at the end of a block are the union of those live at the beginning of each of its successor blocks.

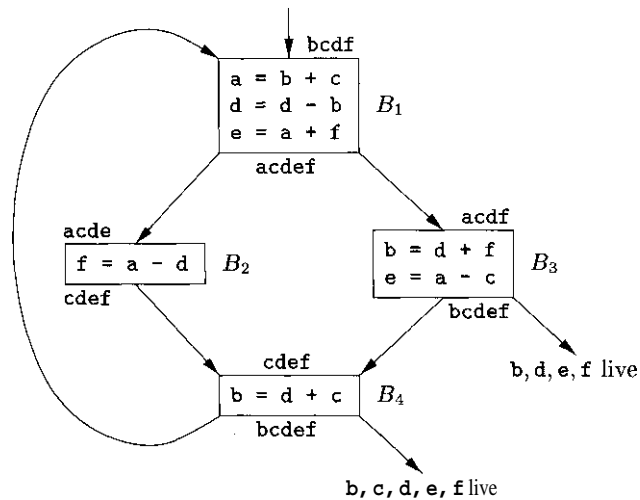

Figure 8.17: Flow graph of an inner loop

To evaluate (8.1) for  $x = a$ , we observe that  $a$  is live on exit from  $B_1$  and is assigned a value there, but is not live on exit from  $B_2$ ,  $B_3$ , or  $B_4$ . Thus,  $J2B \text{ in } L \text{ use}(a.B) = 2$ . Hence the value of (8.1) for  $x = a$  is 4. That is, four units of cost can be saved by selecting  $a$  for one of the global registers. The values of (8.1) for  $b$ ,  $c$ ,  $d$ ,  $e$ , and  $f$  are 5, 3, 6, 4, and 4, respectively. Thus, we may select  $a$ ,  $b$ , and  $d$  for registers  $R_0$ ,  $R_1$ , and  $R_2$ , respectively. Using  $R_0$  for  $e$  or  $f$  instead of  $a$  would be another choice with the same apparent benefit. Figure 8.18 shows the assembly code generated from Fig. 8.17, assuming that the strategy of Section 8.6 is used to generate code for each block. We do not show the generated code for the omitted conditional or unconditional jumps that end each block in Fig. 8.17, and we therefore do not show the generated code as a single stream as it would appear in practice. •

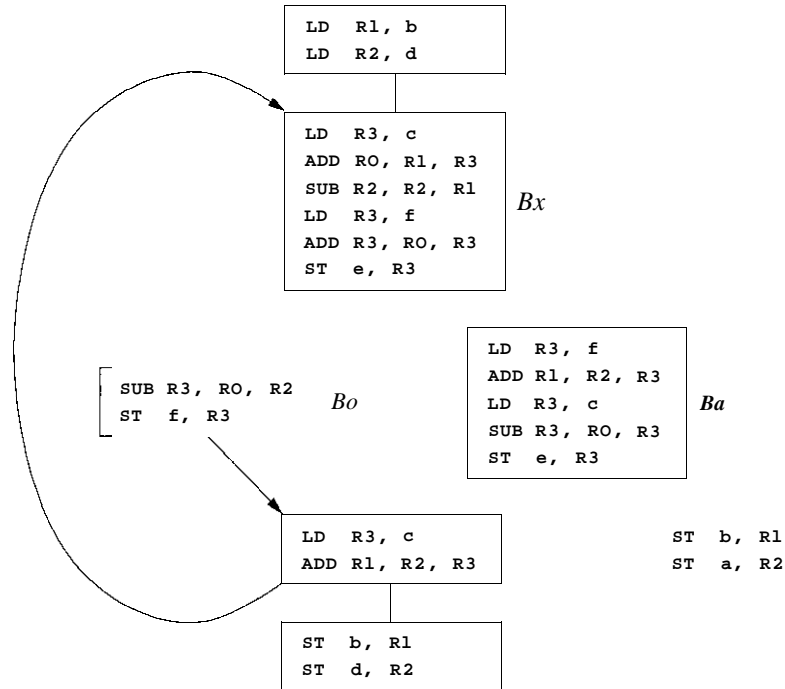

Figure 8.18: Code sequence using global register assignment

### 8.8.3 Register Assignment for Outer Loops

Having assigned registers and generated code for inner loops, we may apply the same idea to progressively larger enclosing loops. If an outer loop  $L$  contains an inner loop  $L_i$ , the names allocated registers in  $L_i$  need not be allocated registers in  $L - L_i$ . Similarly, if we choose to allocate  $x$  a register in  $L_i$  but not  $L$ , we must load  $x$  on entrance to  $L_i$  and store  $x$  on exit from  $L_i$ . We leave as an exercise the derivation of a criterion for selecting names to be allocated registers in an outer loop  $L$ , given that choices have already been made for all loops nested within  $L$ .

### 8.8.4 Register Allocation by Graph Coloring

When a register is needed for a computation but all available registers are in use, the contents of one of the used registers must be stored (*spilled*) into a memory location in order to free up a register. Graph coloring is a simple, systematic technique for allocating registers and managing register spills.

In the method, two passes are used. In the first, target-machine instructions are selected as though there are an infinite number of symbolic registers; in effect, names used in the intermediate code become names of registers and

the three-address instructions become machine-language instructions. If access to variables requires instructions that use stack pointers, display pointers, base registers, or other quantities that assist access, then we assume that these quantities are held in registers reserved for each purpose. Normally, their use is directly translatable into an access mode for an address mentioned in a machine instruction. If access is more complex, the access must be broken into several machine instructions, and a temporary symbolic register (or several) may need to be created.

Once the instructions have been selected, a second pass assigns physical registers to symbolic ones. The goal is to find an assignment that minimizes the cost of spills.

In the second pass, for each procedure a *register-interference graph* is constructed in which the nodes are symbolic registers and an edge connects two nodes if one is live at a point where the other is defined. For example, a register-interference graph for Fig. 8.17 would have nodes for names *a* and *d*. In block *B*<sub>2</sub>, *a* is live at the second statement, which defines *d*; therefore, in the graph there would be an edge between the nodes for *a* and *d*.

An attempt is made to color the register-interference graph using  $k$  colors, where  $k$  is the number of assignable registers. A graph is said to be *colored* if each node has been assigned a color in such a way that no two adjacent nodes have the same color. A color represents a register, and the color makes sure that no two symbolic registers that can interfere with each other are assigned the same physical register.

Although the problem of determining whether a graph is  $k$ -colorable is NP-complete in general, the following heuristic technique can usually be used to do the coloring quickly in practice. Suppose a node  $n$  in a graph  $G$  has fewer than  $k$  neighbors (nodes connected to  $n$  by an edge). Remove  $n$  and its edges from  $G$  to obtain a graph  $G'$ . A  $k$ -coloring of  $G'$  can be extended to a  $k$ -coloring of  $G$  by assigning  $n$  a color not assigned to any of its neighbors.

By repeatedly eliminating nodes having fewer than  $k$  edges from the register-interference graph, either we obtain the empty graph, in which case we can produce a  $k$ -coloring for the original graph by coloring the nodes in the reverse order in which they were removed, or we obtain a graph in which each node has  $k$  or more adjacent nodes. In the latter case a  $k$ -coloring is no longer possible. At this point a node is spilled by introducing code to store and reload the register. Chaitin has devised several heuristics for choosing the node to spill. A general rule is to avoid introducing spill code into inner loops.

### 8.8.5 Exercises for Section 8.8

Exercise 8.8.1: Construct the register-interference graph for the program in Fig. 8.17.

Exercise 8.8.2: Devise a register-allocation strategy on the assumption that we automatically store all registers on the stack before each procedure call and restore them after the return.

## 8.9 Instruction Selection by Tree Rewriting

Instruction selection can be a large combinatorial task, especially on machines that are rich in addressing modes, such as CISC machines, or on machines with special-purpose instructions, say, for signal processing. Even if we assume that the order of evaluation is given and that registers are allocated by a separate mechanism, instruction selection — the problem of selecting target-language instructions to implement the operators in the intermediate representation — remains a large combinatorial task.

In this section, we treat instruction selection as a tree-rewriting problem. Tree representations of target instructions have been used effectively in code-generator generators, which automatically construct the instruction-selection phase of a code generator from a high-level specification of the target machine. Better code might be obtained for some machines by using DAG's rather than trees, but DAG matching is more complex than tree matching.

### 8.9.1 Tree-Translation Schemes

Throughout this section, the input to the code-generation process will be a sequence of trees at the semantic level of the target machine. The trees are what we might get after inserting run-time addresses into the intermediate representation, as described in Section 8.3. In addition, the leaves of the trees contain information about the storage types of their labels.

Example 8.18: Figure 8.19 contains a tree for the assignment statement  $a[i] = b+1$ , where the array  $a$  is stored on the run-time stack and the variable  $b$  is a global in memory location. The run-time addresses of locals  $a$  and  $i$  are given as constant offsets  $C_a$  and  $C_i$  from  $SP$ , the register containing the pointer to the beginning of the current activation record.

The assignment to  $a[i]$  is an indirect assignment in which the r-value of the location for  $a[i]$  is set to the r-value of the expression  $b+1$ . The addresses of array  $a$  and variable  $i$  are given by adding the values of the constant  $C_a$  and  $C_i$ , respectively, to the contents of register  $SP$ . We simplify array-address calculations by assuming that all values are one-byte characters. (Some instruction sets make special provisions for multiplications by constants, such as 2, 4, and 8, during address calculations.)

In the tree, the **ind** operator treats its argument as a memory address. As the left child of an assignment operator, the **ind** node gives the location into which the r-value on the right side of the assignment operator is to be stored. If an argument of a + or **ind** operator is a memory location or a register, then the contents of that memory location or register are taken as the value. The leaves in the tree are labeled with attributes; a subscript indicates the value of the attribute. •

The target code is generated by applying a sequence of tree-rewriting rules to reduce the input tree to a single node. Each tree-rewriting rule has the form

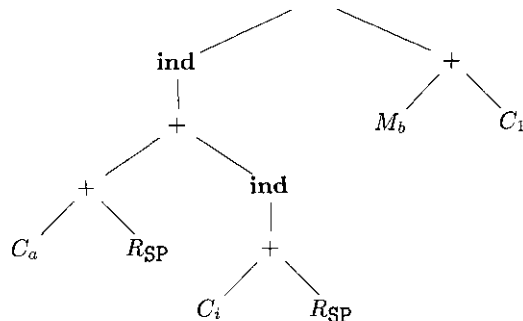
Figure 8.19: Intermediate-code tree for  $a[i] = b + 1$ 

*replacement*  $\leftarrow$  *template* { *action* }

where *replacement* is a single node, *template* is a tree, and *action* is a code fragment, as in a syntax-directed translation scheme.

A set of tree-rewriting rules is called a *tree-translation scheme*.

Each tree-rewriting rule represents the translation of a portion of the tree given by the template. The translation consists of a possibly empty sequence of machine instructions that is emitted by the action associated with the template. The leaves of the template are attributes with subscripts, as in the input tree. Sometimes, certain restrictions apply to the values of the subscripts in the templates; these restrictions are specified as semantic predicates that must be satisfied before the template is said to match. For example, a predicate might specify that the value of a constant fall in a certain range.

A tree-translation scheme is a convenient way to represent the instruction-selection phase of a code generator. As an example of a tree-rewriting rule, consider the rule for the register-to-register add instruction:

$$R_i \leftarrow \begin{array}{c} + \\ \begin{array}{cc} \wedge & \\ R_i & R_j \end{array} \end{array} \quad \{ \text{ADD } R_i, R_i, R_j \}$$

This rule is used as follows. If the input tree contains a subtree that matches this tree template, that is, a subtree whose root is labeled by the operator  $+$  and whose left and right children are quantities in registers  $i$  and  $j$ , then we can replace that subtree by a single node labeled  $R_i$  and emit the instruction **ADD**  $R_i, R_i, R_j$  as output. We call this replacement a *tiling* of the subtree. More than one template may match a subtree at a given time; we shall describe shortly some mechanisms for deciding which rule to apply in cases of conflict.

**Example 8.19:** Figure 8.20 contains tree-rewriting rules for a few instructions of our target machine. These rules will be used in a running example throughout this section. The first two rules correspond to load instructions, the next two

to store instructions, and the remainder to indexed loads and additions. Note that rule (8) requires the value of the constant to be 1. This condition would be specified by a semantic predicate. •

## 8.9.2 Code Generation by Tiling an Input Tree

A tree-translation scheme works as follows. Given an input tree, the templates in the tree-rewriting rules are applied to tile its subtrees. If a template matches, the matching subtree in the input tree is replaced with the replacement node of the rule and the action associated with the rule is done. If the action contains a sequence of machine instructions, the instructions are emitted. This process is repeated until the tree is reduced to a single node, or until no more templates match. The sequence of machine instructions generated as the input tree is reduced to a single node constitutes the output of the tree-translation scheme on the given input tree.

The process of specifying a code generator becomes similar to that of using a syntax-directed translation scheme to specify a translator. We write a tree-translation scheme to describe the instruction set of a target machine. In practice, we would like to find a scheme that causes a minimal-cost instruction sequence to be generated for each input tree. Several tools are available to help build a code generator automatically from a tree-translation scheme.

**Example 8.20:** Let us use the tree-translation scheme in Fig. 8.20 to generate code for the input tree in Fig. 8.19. Suppose that the first rule is applied to load the constant  $C_i$  into register  $RO$ :

$$1) \quad R_o \wedge C_i \quad \{ LD \ RO, \ #a \}$$

The label of the leftmost leaf then changes from  $C_i$  to  $R_o$  and the instruction **LD RO, #a** is generated. The seventh rule now matches the leftmost subtree with root labeled +:

$$7) \quad R_o \leftarrow \begin{array}{c} + \\ / \quad \backslash \\ R_o \quad T_{igp} \end{array} \quad \{ ADD \ RO, \ RO, \ SP \}$$

Using this rule, we rewrite this subtree as a single node labeled  $RQ$  and generate the instruction **ADD RO, RO, SP**. Now the tree looks like

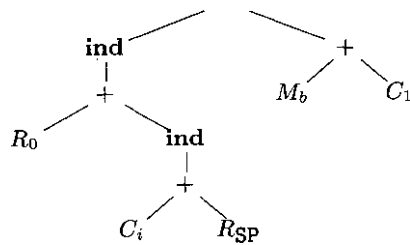

1)	$Ri \leftarrow C_x$	{ LD $Ri, \#a$ }
2)	$Ri \leftarrow M_x$	{ LD $Ri > x$ }
3)	$M \leftarrow \begin{array}{c} / \quad \backslash \\ M_x \quad Ri \end{array}$	{ ST $x, Ri$ }
4)	$M \leftarrow r- \begin{array}{c} \cdot / \quad \backslash \\ ind \quad Rj \\ Ri \end{array}$	{ ST $*Ri, Rj$ }
5)	$Ri \leftarrow \begin{array}{c} ind \\ + \\ Ca \quad Rj \end{array}$	{ LD $Ri, a(Rj)$ }
6)	$Ri \leftarrow r\sim \begin{array}{c} + \\ / \quad \backslash \\ Ri \quad ind \\ + \\ Ca \quad Rj \end{array}$	{ ADD $Ri, Ri, a(Rj)$ }
7)	$Ri \leftarrow \begin{array}{c} + \\ / \quad \backslash \\ Ri \quad Rj \end{array}$	{ ADD $Ri, Ri, Rj$ }
8)	$Ri \leftarrow r- \begin{array}{c} + \\ / \quad \backslash \\ Ri \quad C \end{array}$	{ INC $Ri$ }

Figure 8.20: Tree-rewriting rules for some target-machine instructions



At this point, we could apply rule (5) to reduce the subtree

$$\begin{array}{c} \text{ind} \\ \mathbf{I} \\ \\ d \quad R\$p \end{array}$$

to a single node labeled, say,  $R_0$ . We could also use rule (6) to reduce the larger subtree

$$\begin{array}{c} R_0 \quad \text{ind} \\ \\ + \\ C_i \quad \mathbf{i?gp} \end{array}$$

to a single node labeled  $R_0$  and generate the instruction **ADD RO, RO, i(SP)**. Assuming that it is more efficient to use a single instruction to compute the larger subtree rather than the smaller one, we choose rule (6) to get

$$\begin{array}{c} \text{---} \\ / \quad \backslash \\ \text{ind} \quad + \\ | \quad / \quad \backslash \\ R_0 \quad M_b \quad C_1 \end{array}$$

In the right subtree, rule (2) applies to the leaf  $C_1$ . It generates an instruction to load  $b$  into register  $\mathbf{R1}$ , say. Now, using rule (8) we can match the subtree

$$\begin{array}{c} + \\ / \quad \backslash \\ R_i \quad C_i \end{array}$$

and generate the increment instruction **INC R1**. At this point, the input tree has been reduced to

$$\begin{array}{c} \text{incf}^{\wedge} \quad \mathbf{.R1} \\ \\ \mathbf{-R_0} \end{array}$$

This remaining tree is matched by rule (4), which reduces the tree to a single node and generates the instruction **ST \*R0, R1**. We generate the following code sequence:

```
LD R0, #a
ADD RO, RO, SP
ADD RO, RO, i(SP)
LD R1, b
INC R1
ST *R0, R1
```

in the process of reducing the tree to a single node. •

In order to implement the tree-reduction process in Example 8.18, we must address some issues related to tree-pattern matching:

- How is tree-pattern matching to be done? The efficiency of the code-generation process (at compile time) depends on the efficiency of the tree-matching algorithm.
- What do we do if more than one template matches at a given time? The efficiency of the generated code (at run time) may depend on the order in which templates are matched, since different match sequences will in general lead to different target-machine code sequences, some more efficient than others.

If no template matches, then the code-generation process blocks. At the other extreme, we need to guard against the possibility of a single node being rewritten indefinitely, generating an infinite sequence of register move instructions or an infinite sequence of loads and stores.

To prevent blocking, we assume that each operator in the intermediate code can be implemented by one or more target-machine instructions. We further assume that there are enough registers to compute each tree node by itself. Then, no matter how the tree matching proceeds, the remaining tree can always be translated into target-machine instructions.

### 8.9.3 Pattern Matching by Parsing

Before considering general tree matching, we consider a specialized approach that uses an LR parser to do the pattern matching. The input tree can be treated as a string by using its prefix representation. For example, the prefix representation for the tree in Fig. 8.19 is

$$= \text{ind} + + C_i \text{ i?}_{sp} \text{ ind} + d R\$ + M_i d$$

The tree-translation scheme can be converted into a syntax-directed translation scheme by replacing the tree-rewriting rules with the productions of a context-free grammar in which the right sides are prefix representations of the instruction templates.

Example 8.21: The syntax-directed translation scheme in Fig. 8.21 is based on the tree-translation scheme in Fig. 8.20.

The nonterminals of the underlying grammar are  $R$  and  $M$ . The terminal  $m$  represents a specific memory location, such as the location for the global variable  $b$  in Example 8.18. The production  $M \rightarrow m$  in Rule (10) can be thought of as matching  $M$  with  $m$  prior to using one of the templates involving  $M$ . Similarly, we introduce a terminal  $sp$  for register  $SP$  and add the production  $R \rightarrow SP$ . Finally, terminal  $c$  represents constants.

Using these terminals, the string for the input tree in Fig. 8.19 is

1) $R_i \rightarrow t$	{ LD $R_i, \#a$ }
2) $R_i \rightarrow x$	{ LD $R_i, x$ }
3) $M \rightarrow =$	{ ST $a, R_i$ }
4) $M \rightarrow = \text{ind } jR_j$	{ ST $*R_i, R_j$ }
5) $R_i \rightarrow \text{ind } + c_j R_j$	{ LD $R_i, o(R_j)$ }
6) $R_i \rightarrow + R_i \text{ ind } + c_j$	{ ADD $R_i, R_i, o(R_j)$ }
7) $R_i \rightarrow + \wedge \text{ind}$	{ ADD $R_i, R_i, R_j$ }
8) $R_i \rightarrow + R_i c_i$	{ INC $R_i$ }
9) $R \rightarrow \text{sp}$	
10) $M \rightarrow m$	

Figure 8.21: Syntax-directed translation scheme constructed from Fig. 8.20

= ind + + c<sub>j</sub> sp ind + c<sub>j</sub> sp + m&c<sub>i</sub>

From the productions of the translation scheme we build an LR parser using one of the LR-parser construction techniques of Chapter 4. The target code is generated by emitting the machine instruction corresponding to each reduction.

A code-generation grammar is usually highly ambiguous, and some care needs to be given to how the parsing-action conflicts are resolved when the parser is constructed. In the absence of cost information, a general rule is to favor larger reductions over smaller ones. This means that in a reduce-reduce conflict, the longer reduction is favored; in a shift-reduce conflict, the shift move is chosen. This "maximal munch" approach causes a larger number of operations to be performed with a single machine instruction.

There are some benefits to using LR parsing in code generation. First, the parsing method is efficient and well understood, so reliable and efficient code generators can be produced using the algorithms described in Chapter 4. Second, it is relatively easy to retarget the resulting code generator; a code selector for a new machine can be constructed by writing a grammar to describe the instructions of the new machine. Third, the quality of the code generated can be made efficient by adding special-case productions to take advantage of machine idioms.

However, there are some challenges as well. A left-to-right order of evaluation is fixed by the parsing method. Also, for some machines with large numbers of addressing modes, the machine-description grammar and resulting parser can become inordinately large. As a consequence, specialized techniques are necessary to encode and process the machine-description grammars. We must also be careful that the resulting parser does not block (has no next move) while parsing an expression tree, either because the grammar does not handle some operator patterns or because the parser has made the wrong resolution of some parsing-action conflict. We must also make sure the parser does not get into an

infinite loop of reductions of productions with single symbols on the right side. The looping problem can be solved using a state-splitting technique at the time the parser tables are generated.

### 8.9.4 Routines for Semantic Checking

In a code-generation translation scheme, the same attributes appear as in an input tree, but often with restrictions on what values the subscripts can have. For example, a machine instruction may require that an attribute value fall in a certain range or that the values of two attributes be related.

These restrictions on attribute values can be specified as predicates that are invoked before a reduction is made. In fact, the general use of semantic actions and predicates can provide greater flexibility and ease of description than a purely grammatical specification of a code generator. Generic templates can be used to represent classes of instructions and the semantic actions can then be used to pick instructions for specific cases. For example, two forms of the addition instruction can be represented with one template:

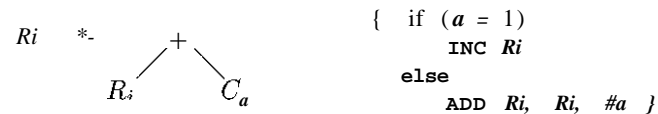

Parsing-action conflicts can be resolved by disambiguating predicates that can allow different selection strategies to be used in different contexts. A smaller description of a target machine is possible because certain aspects of the machine architecture, such as addressing modes, can be factored into the attributes. The complication in this approach is that it may become difficult to verify the accuracy of the translation scheme as a faithful description of the target machine, although this problem is shared to some degree by all code generators.

### 8.9.5 General Tree Matching

The LR-parsing approach to pattern matching based on prefix representations favors the left operand of a binary operator. In a prefix representation of  $E \setminus E$ , the limited-lookahead LR parsing decisions must be made on the basis of some prefix of  $Ei$ , since  $E \setminus$  can be arbitrarily long. Thus, pattern matching can miss nuances of the target-instruction set that are due to right operands.

Instead prefix representation, we could use a postfix representation. But, then an LR-parsing approach to pattern matching would favor the right operand.

For a hand-written code generator, we can use tree templates, as in Fig. 8.20, as a guide and write an ad-hoc matcher. For example, if the root of the input tree is labeled ind, then the only pattern that could match is for rule (5); otherwise, if the root is labeled +, then the patterns that could match are for rules (6-8).

For a code-generator generator, we need a general tree-matching algorithm. An efficient top-down algorithm can be developed by extending the string-pattern-matching techniques of Chapter 3. The idea is to represent each template as a set of strings, where a string corresponds to a path from the root to a leaf in the template. We treat all operands equally by including the position number of a child, from left to right, in the strings.

Example 8.22: In building the set of strings for an instruction set, we shall drop the subscripts, since pattern matching is based on the attributes alone, not on their values.

The templates in Fig. 8.22 have the following set of strings from the root to a leaf:

$C$   
 $+ 1 R$   
 $+ 2 \text{ ind } 1 + 1 C$   
 $+ 2 \text{ ind } 1 + 2 R$   
 $+ 2 R$

The string  $C$  represents the template with  $C$  at the root. The string  $+1R$  represents the  $+$  and its left operand  $R$  in the two templates that have  $+$  at the root. •

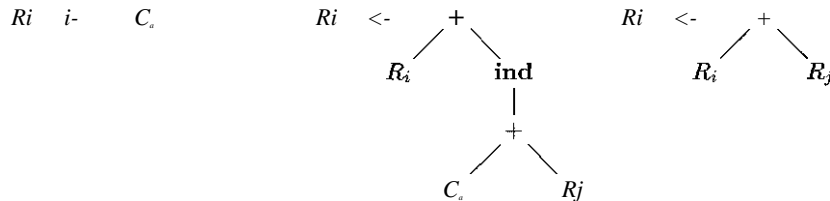

Figure 8.22: An instruction set for tree matching

Using sets of strings as in Example 8.22, a tree-pattern matcher can be constructed by using techniques for efficiently matching multiple strings in parallel.

In practice, the tree-rewriting process can be implemented by running the tree-pattern matcher during a depth-first traversal of the input tree and performing the reductions as the nodes are visited for the last time.

Instruction costs can be taken into account by associating with each tree-rewriting rule the cost of the sequence of machine instructions generated if that rule is applied. In Section 8.11, we discuss a dynamic programming algorithm that can be used in conjunction with tree-pattern matching.

By running the dynamic programming algorithm concurrently, we can select an optimal sequence of matches using the cost information associated with each rule. We may need to defer deciding upon a match until the cost of all alternatives is known. Using this approach, a small, efficient code generator can

be constructed quickly from a tree-rewriting scheme. Moreover, the dynamic programming algorithm frees the code-generator designer from having to resolve conflicting matches or decide upon an order for the evaluation.

### 8.9.6 Exercises for Section 8.9

**Exercise 8.9.1:** Construct syntax trees for each of the following statements assuming all nonconstant operands are in memory locations:

a)  $x = a * b + c * d ;$

b)  $x[i] = y[j] * z[k];$

c)  $x = x + 1;$

Use the tree-rewriting scheme in Fig. 8.20 to generate code for each statement.

**Exercise 8.9.2:** Repeat Exercise 8.9.1 above using the syntax-directed translation scheme in Fig. 8.21 in place of the tree-rewriting scheme.

! **Exercise 8.9.3:** Extend the tree-rewriting scheme in Fig. 8.20 to apply to while-statements.

! **Exercise 8.9.4:** How would you extend tree rewriting to apply to DAG's?

## 8.10 Optimal Code Generation for Expressions

We can choose registers optimally when a basic block consists of a single expression evaluation, or if we accept that it is sufficient to generate code for a block one expression at a time. In the following algorithm, we introduce a numbering scheme for the nodes of an expression tree (a syntax tree for an expression) that allows us to generate optimal code for an expression tree when there is a fixed number of registers with which to evaluate the expression.

### 8.10.1 Ershov Numbers

We begin by assigning to the nodes of an expression tree a number that tells how many registers are needed to evaluate that node without storing any temporaries. These numbers are sometimes called *Ershov numbers*, after A. Ershov, who used a similar scheme for machines with a single arithmetic register. For our machine model, the rules are:

1. Label any leaf 1.
2. The label of an interior node with one child is the label of its child.
3. The label of an interior node with two children is

- (a) The larger of the labels of its children, if those labels are different.
- (b) One plus the label of its children if the labels are the same.

Example 8.23 : In Fig. 8.23 we see an expression tree (with operators omitted) that might be the tree for expression  $(a - b) + e \times (c + d)$  or the three-address code:

```
t1 = a - b
t2 = c + d
t3 = e * t2
t4 = t1 + t3
```

Each of the five leaves is labeled 1 by rule (1). Then, we can label the interior node for  $t1 = a - b$ , since both of its children are labeled. Rule (3b) applies, so it gets label one more than the labels of its children, that is, 2. The same holds for the interior node for  $t2 = c + d$ .

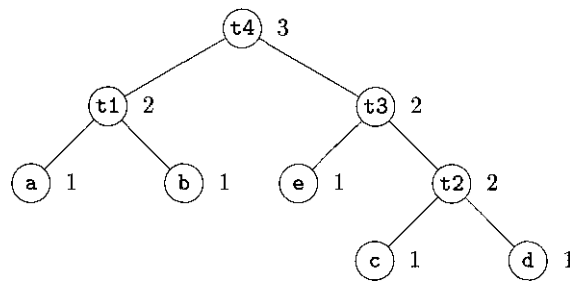

Figure 8.23: A tree labeled with Ershov numbers

Now, we can work on the node for  $t3 = e * t2$ . Its children have labels 1 and 2, so the label of the node for  $t3$  is the maximum, 2, by rule (3a). Finally, the root, the node for  $t4 = t1 + t3$ , has two children with label 2, and therefore it gets label 3. •

### 8.10.2 Generating Code From Labeled Expression Trees

It can be proved that, in our machine model, where all operands must be in registers, and registers can be used by both an operand and the result of an operation, the label of a node is the fewest registers with which the expression can be evaluated using no stores of temporary results. Since in this model, we are forced to load each operand, and we are forced to compute the result corresponding to each interior node, the only thing that can make the generated code inferior to the optimal code is if there are unnecessary stores of temporaries. The argument for this claim is embedded in the following algorithm for generating code with no stores of temporaries, using a number of registers equal to the label of the root.

Algorithm 8.24: Generating code from a labeled expression tree.

**INPUT:** A labeled tree with each operand appearing once (that is, no common subexpressions).

**OUTPUT:** An optimal sequence of machine instructions to evaluate the root into a register.

**METHOD:** The following is a recursive algorithm to generate the machine code. The steps below are applied, starting at the root of the tree. If the algorithm is applied to a node with label  $k$ , then only  $k$  registers will be used. However, there is a "base"  $b > 1$  for the registers used so that the actual registers used are  $R_b, R_{b+i}, \dots, R_{b+k-i}$ . The result always appears in  $R_{b+i}$ .

1. To generate machine code for an interior node with label  $k$  and two children with equal labels (which must be  $k - 1$ ) do the following:
  - (a) Recursively generate code for the right child, using base  $b + 1$ . The result of the right child appears in register  $R_{b+k}$ .
  - (b) Recursively generate code for the left child, using base  $b$ ; the result appears in  $R_{b+k-i}$ .
  - (c) Generate the instruction  $\text{OP } R_{b+k}, R_{b+k-i}, R_{b+k}$ , where  $\text{OP}$  is the appropriate operation for the interior node in question.
2. Suppose we have an interior node with label  $k$  and children with unequal labels. Then one of the children, which we'll call the "big" child, has label  $k$ , and the other child, the "little" child, has some label  $m < k$ . Do the following to generate code for this interior node, using base  $b$ :
  - (a) Recursively generate code for the big child, using base  $b$ ; the result appears in register  $R_{b+k-i}$ .
  - (b) Recursively generate code for the small child, using base  $b$ ; the result appears in register  $R_{b+m-i}$ . Note that since  $m < k$ , neither  $R_{b+k-i}$  nor any higher-numbered register is used.
  - (c) Generate the instruction  $\text{OP } R_{b+k-i}, R_{b+m-i}, R_{b+k-i}$  or the instruction  $\text{OP } R_{b+k-i}, R_{b+k-i}, R_{b+m-i}$ , depending on whether the big child is the right or left child, respectively.
3. For a leaf representing operand  $x$ , if the base is  $b$  generate the instruction  $\text{LD } R_b, x$ .

Example 8.25: Let us apply Algorithm 8.24 to the tree of Fig. 8.23. Since the label of the root is 3, the result will appear in  $R_3$ , and only  $R_3$ ,  $R_2$ , and  $R_1$  will be used. The base for the root is  $b = 1$ . Since the root has children of equal labels, we generate code for the right child first, with base 2.

When we generate code for the right child of the root, labeled t3, we find the big child is the right child and the little child is the left child. We thus generate code for the right child first, with  $b = 2$ . Applying the rules for equal-labeled children and leaves, we generate the following code for the node labeled ii:



```
LD R3, d
LD R2, c
ADD R3, R2, R3
```

Next, we generate code for the left child of the right child of the root; this node is the leaf labeled  $e$ . Since  $b - 2$ , the proper instruction is

```
LD R2, e
```

Now we can complete the code for the right child of the root by adding the instruction

```
MUL R3, R2, R3
```

The algorithm proceeds to generate code for the left child of the root, leaving the result in  $R_3$ , and with base 1. The complete sequence of instructions is shown in Fig. 8.24. •

```
LD R3, d
LD R2, c
ADD R3, R2, R3
LD R2, e
MUL R3, R2, R3
LD R2, b
LD R1, a
SUB R2, R1, R2
ADD R3, R2, R3
```

Figure 8.24: Optimal three-register code for the tree of Fig. 8.23

### 8.10.3 Evaluating Expressions with an Insufficient Supply of Registers

When there are fewer registers available than the label of the root of the tree, we cannot apply Algorithm 8.24 directly. We need to introduce some store instructions that spill values of subtrees into memory, and we then need to load those values back into registers as needed. Here is the modified algorithm that takes into account a limitation on the number of registers.

Algorithm 8.26: Generating code from a labeled expression tree.

**INPUT:** A labeled tree with each operand appearing once (i.e., no common subexpressions) and a number of registers  $r > 2$ .

**OUTPUT:** An optimal sequence of machine instructions to evaluate the root into a register, using no more than  $r$  registers, which we assume are  $R_1, R_2, \dots, R_r$ .

**METHOD:** Apply the following recursive algorithm, starting at the root of the tree, with  $\delta = 1$ . For a node  $N$  with label  $r$  or less, the algorithm is exactly the same as Algorithm 8.24, and we shall not repeat those steps here. However, for interior nodes with a label  $k > r$ , we need to work on each side of the tree separately and store the result of the larger subtree. That result is brought back into memory just before node  $N$  is evaluated, and the final step will take place in registers  $R_{i-1}$  and  $R_i$ . The modifications to the basic algorithm are as follows:

1. Node  $N$  has at least one child with label  $r$  or greater. Pick the larger child (or either if their labels are the same) to be the "big" child and let the other child be the "little" child.
2. Recursively generate code for the big child, using  $\delta = 1$ . The result of this evaluation will appear in register  $R_i$ .
3. Generate the machine instruction  $ST\ tk, R_i$ , where  $t$  is a temporary variable used for temporary results used to help evaluate nodes with label  $k$ .
4. Generate code for the little child as follows. If the little child has label  $r$  or greater, pick  $\delta = 1$ . If the label of the little child is  $j < r$ , then pick  $\delta = r - j$ . Then recursively apply this algorithm to the little child; the result appears in  $R_{i-1}$ .
5. Generate the instruction  $LD\ R_{i-1}, tk$ .
6. If the big child is the right child of  $N$ , then generate the instruction  $OP\ R_i, R_{i-1}, R_i$ . If the big child is the left child, generate  $OP\ R_i, R_i, R_{i-1}$ .

Example 8.27: Let us revisit the expression represented by Fig. 8.23, but now assume that  $r = 2$ ; that is, only registers  $R_1$  and  $R_2$  are available to hold temporaries used in the evaluation of expressions. When we apply Algorithm 8.26 to Fig. 8.23, we see that the root, with label 3, has a label that is larger than  $r = 2$ . Thus, we need to identify one of the children as the "big" child. Since they have equal labels, either would do. Suppose we pick the right child as the big child.

Since the label of the big child of the root is 2, there are enough registers. We thus apply Algorithm 8.24 to this subtree, with  $\delta = 1$  and two registers. The result looks very much like the code we generated in Fig. 8.24, but with registers  $R_1$  and  $R_2$  in place of  $R_2$  and  $R_3$ . This code is

```
LD R2, d
LD R1, c
ADD R2, R1, R2
LD R1, e
MUL R2, R1, R2
```

Now, since we need both registers for the left child of the root, we need to generate the instruction

```
ST t3, R2
```

Next, the left child of the root is handled. Again, the number of registers is sufficient for this child, and the code is

```
LD R2, b
LD R1, a
SUB R2, R1, R2
```

Finally, we reload the temporary that holds the right child of the root with the instruction

```
LD R1, t3
```

and execute the operation at the root of the tree with the instruction

```
ADD R2, R2, R1
```

The complete sequence of instructions is shown in Fig. 8.25. •

```
LD R2 d
LD R1 c
ADD R2 R1, R2
LD R1 e
MUL R2 R1, R2
ST t3 R2
LD R2 b
LD R1 a
SUB R2 R1, R2
LD R1 t3
ADD R2 R2, R1
```

Figure 8.25: Optimal three-register code for the tree of Fig. 8.23, using only two registers

#### 8.10.4 Exercises for Section 8.10

**Exercise 8.10.1:** Compute Ershov numbers for the following expressions:

- $a/(b + c) - d * (e + f)$ .
- $a + b * (c * (d + e))$ .

$$c) \quad (-a + *p)*((b-*q)/(-c+*r)).$$

**Exercise 8.10.2:** Generate optimal code using two registers for each of the expressions of Exercise 8.10.1.

**Exercise 8.10.3:** Generate optimal code using three registers for each of the expressions of Exercise 8.10.1.

! **Exercise 8.10.4:** Generalize the computation of Ershov numbers to expression trees with interior nodes with three or more children.

! **Exercise 8.10.5:** An assignment to an array element, such as  $a[i] = x$ , appears to be an operator with three operands:  $a$ ,  $i$ , and  $x$ . How would you modify the tree-labeling scheme to generate optimal code for this machine model?

! **Exercise 8.10.6:** The original Ershov numbers were used for a machine that allowed the right operand of an expression to be in memory, rather than a register. How would you modify the tree-labeling scheme to generate optimal code for this machine model?

! **Exercise 8.10.7:** Some machines require two registers for certain single-precision values. Suppose that the result of a multiplication of single-register quantities requires two consecutive registers, and when we divide  $a/6$ , the value of  $a$  must be held in two consecutive registers. How would you modify the tree-labeling scheme to generate optimal code for this machine model?

## 8.11 Dynamic Programming Code-Generation

Algorithm 8.26 in Section 8.10 produces optimal code from an expression tree using an amount of time that is a linear function of the size of the tree. This procedure works for machines in which all computation is done in registers and in which instructions consist of an operator applied to two registers or to a register and a memory location.

An algorithm based on the principle of dynamic programming can be used to extend the class of machines for which optimal code can be generated from expression trees in linear time. The dynamic programming algorithm applies to a broad class of register machines with complex instruction sets.

The dynamic programming algorithm can be used to generate code for any machine with  $r$  interchangeable registers  $R_0, R_1, \dots, R_{r-1}$  and load, store, and add instructions. For simplicity, we assume every instruction costs one unit, although the dynamic programming algorithm can easily be modified to work even if each instruction has its own cost.

### 8.11.1 Contiguous Evaluation

The dynamic programming algorithm partitions the problem of generating optimal code for an expression into the subproblems of generating optimal code for the subexpressions of the given expression. As a simple example, consider an expression  $E$  of the form  $E_1 + E_2$ . An optimal program for  $E$  is formed by combining optimal programs for  $E_1$  and  $E_2$ , in one or the other order, followed by code to evaluate the operator  $+$ . The subproblems of generating optimal code for  $E_1$  and  $E_2$  are solved similarly.

An optimal program produced by the dynamic programming algorithm has an important property. It evaluates an expression  $E = E_1 \text{ op } E_2$  "contiguously." We can appreciate what this means by looking at the syntax tree  $T$  for  $E$ :

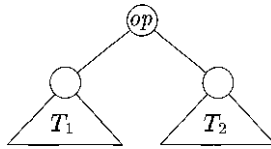

Here  $T_1$  and  $T_2$  are trees for  $E_1$  and  $E_2$ , respectively.

We say a program  $P$  evaluates a tree  $T$  *contiguously* if it first evaluates those subtrees of  $T$  that need to be computed into memory. Then, it evaluates the remainder of  $T$  either in the order  $T_1, T_2$ , and then the root, or in the order  $T_2, T_1$ , and then the root, in either case using the previously computed values from memory whenever necessary. As an example of noncontiguous evaluation,  $P$  might first evaluate part of  $T_1$  leaving the value in a register (instead of memory), next evaluate  $T_2$ , and then return to evaluate the rest of  $T_1$ .

For the register machine in this section, we can prove that given any machine-language program  $P$  to evaluate an expression tree  $T$ , we can find an equivalent program  $P'$  such that

1.  $P'$  is of no higher cost than  $P$ ,
2.  $P'$  uses no more registers than  $P$ , and
3.  $P'$  evaluates the tree contiguously.

This result implies that every expression tree can be evaluated optimally by a contiguous program.

By way of contrast, machines with even-odd register pairs do not always have optimal contiguous evaluations; the x86 architecture uses register pairs for multiplication and division. For such machines, we can give examples of expression trees in which an optimal machine language program must first evaluate into a register a portion of the left subtree of the root, then a portion of the right subtree, then another part of the left subtree, then another part of the right, and so on. This type of oscillation is unnecessary for an optimal evaluation of any expression tree using the machine in this section.

The contiguous evaluation property defined above ensures that for any expression tree  $T$  there always exists an optimal program that consists of optimal programs for subtrees of the root, followed by an instruction to evaluate the root. This property allows us to use a dynamic programming algorithm to generate an optimal program for  $T$ .

### 8.11.2 The Dynamic Programming Algorithm

The dynamic programming algorithm proceeds in three phases (suppose the target machine has  $r$  registers):

1. Compute bottom-up for each node  $n$  of the expression tree  $T$  an array  $C$  of costs, in which the  $z$ th component  $C[i]$  is the optimal cost of computing the subtree  $S$  rooted at  $n$  into a register, assuming  $i$  registers are available for the computation, for  $1 < i < r$ .
2. Traverse  $T$ , using the cost vectors to determine which subtrees of  $T$  must be computed into memory.
3. Traverse each tree using the cost vectors and associated instructions to generate the final target code. The code for the subtrees computed into memory locations is generated first.

Each of these phases can be implemented to run in time linearly proportional to the size of the expression tree.

The cost of computing a node  $n$  includes whatever loads and stores are necessary to evaluate  $S$  in the given number of registers. It also includes the cost of computing the operator at the root of  $S$ . The zeroth component of the cost vector is the optimal cost of computing the subtree  $S$  into memory. The contiguous evaluation property ensures that an optimal program for  $S$  can be generated by considering combinations of optimal programs only for the subtrees of the root of  $S$ . This restriction reduces the number of cases that need to be considered.

In order to compute the costs  $C[i]$  at node  $n$ , we view the instructions as tree-rewriting rules, as in Section 8.9. Consider each template  $E$  that matches the input tree at node  $n$ . By examining the cost vectors at the corresponding descendants of  $n$ , determine the costs of evaluating the operands at the leaves of  $E$ . For those operands of  $E$  that are registers, consider all possible orders in which the corresponding subtrees of  $T$  can be evaluated into registers. In each ordering, the first subtree corresponding to a register operand can be evaluated using  $i$  available registers, the second using  $i-1$  registers, and so on. To account for node  $n$ , add in the cost of the instruction associated with the template  $E$ . The value  $C[i]$  is then the minimum cost over all possible orders.

The cost vectors for the entire tree  $T$  can be computed bottom up in time linearly proportional to the number of nodes in  $T$ . It is convenient to store at each node the instruction used to achieve the best cost for  $C[i]$  for each value

of  $i$ . The smallest cost in the vector for the root of  $T$  gives the minimum cost of evaluating  $T$ .

**Example 8.28:** Consider a machine having two registers **RO** and **R1**, and the following instructions, each of unit cost:

<b>LD</b>	<b>Ri, Kj</b>	<b>// Ri</b>	<b>= Mj</b>
<i>op</i>	<b>Ri, Ri, Ri</b>	<b>// Ri</b>	<b>= Ri op Rj</b>
<i>op</i>	<b>Ri, Ri, Mi</b>	<b>// Ri</b>	<b>= Ri op Kj</b>
<b>LD</b>	<b>Ri, Ri</b>	<b>// Ri</b>	<b>= Ri</b>
<b>ST</b>	<b>Hi, Ri</b>	<b>// Mi</b>	<b>= Rj</b>

In these instructions, **Ri** is either **RO** or **R1**, and **Mi** is a memory location. The operator *op* corresponds to an arithmetic operators.

Let us apply the dynamic programming algorithm to generate optimal code for the syntax tree in Fig 8.26. In the first phase, we compute the cost vectors shown at each node. To illustrate this cost computation, consider the cost vector at the leaf **a**.  $C[0]$ , the cost of computing **a** into memory, is 0 since it is already there.  $C[1]$ , the cost of computing **a** into a register, is 1 since we can load it into a register with the instruction **LD RO, a**.  $C[2]$ , the cost of loading **a** into a register with two registers available, is the same as that with one register available. The cost vector at leaf **a** is therefore  $(0,1,1)$ .

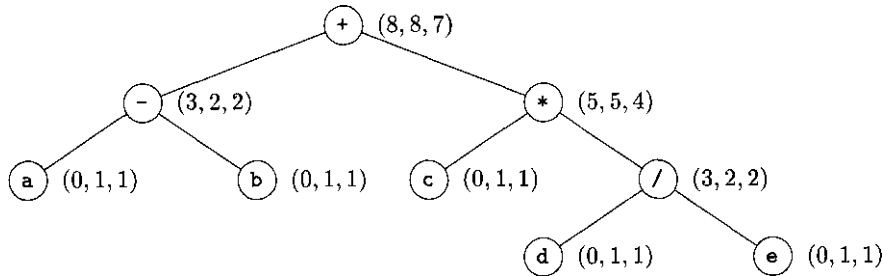

Figure 8.26: Syntax tree for  $(a-b)+c*(d/e)$  with cost vector at each node

Consider the cost vector at the root. We first determine the minimum cost of computing the root with one and two registers available. The machine instruction **ADD RO, RO, M** matches the root, because the root is labeled with the operator **+**. Using this instruction, the minimum cost of evaluating the root with one register available is the minimum cost of computing its right subtree into memory, plus the minimum cost of computing its left subtree into the register, plus 1 for the instruction. No other way exists. The cost vectors at the right and left children of the root show that the minimum cost of computing the root with one register available is  $5 + 2 + 1 = 8$ .

Now consider the minimum cost of evaluating the root with two registers available. Three cases arise depending on which instruction is used to compute the root and in what order the left and right subtrees of the root are evaluated.

1. Compute the left subtree with two registers available into register **RO**, compute the right subtree with one register available into register **R1**, and use the instruction **ADD RO, RO, R1** to compute the root. This sequence has cost  $2 + 5 + 1 = 8$ .
2. Compute the right subtree with two registers available into **R1**, compute the left subtree with one register available into **RO**, and use the instruction **ADD RO, RO, R1**. This sequence has cost  $4 + 2 + 1 = 7$ .
3. Compute the right subtree into memory location **M**, compute the left subtree with two registers available into register **RO**, and use the instruction **ADD RO, RO, M**. This sequence has cost  $5 + 2 + 1 = 8$ .

The second choice gives the minimum cost 7.

The minimum cost of computing the root into memory is determined by adding one to the minimum cost of computing the root with all registers available; that is, we compute the root into a register and then store the result. The cost vector at the root is therefore (8,8,7).

From the cost vectors we can easily construct the code sequence by making a traversal of the tree. From the tree in Fig. 8.26, assuming two registers are available, an optimal code sequence is

```
LD  RO, c           // RO = c
LD  R1, d           // R1 = d
DIV  R1, R1, e      // R1 = R1 / e
MUL  RO, RO, R1     // RO = RO * R1
LD  R1, a           // R1 = a
SUB  R1, R1, b      // R1 = R1 - b
ADD  R1, R1, RO     // R1 = R1 + RO
```

•

Dynamic programming techniques have been used in a number of compilers, including the second version of the portable C compiler, PCC2. The technique facilitates retargeting because of the applicability of the dynamic programming technique to a broad class of machines.

### 8.11.3 Exercises for Section 8.11

Exercise 8.11.1: Augment the tree-rewriting scheme in Fig. 8.20 with costs, and use dynamic programming and tree matching to generate code for the statements in Exercise 8.9.1.

!! Exercise 8.11.2: How would you extend dynamic programming to do optimal code generation on dags?



## 8.12 Summary of Chapter 8

- 4- *Code generation* is the final phase of a compiler. The code generator maps the intermediate representation produced by the front end, or if there is a code optimization phase by the code optimizer, into the target program.
- *Instruction selection* is the process of choosing target-language instructions for each IR statement.
- *Register allocation* is the process of deciding which IR values to keep in registers. Graph coloring is an effective technique for doing register allocation in compilers.
- *Register assignment* is the process of deciding which register should hold a given IR value.
- A *retargetable compiler* is one that can generate code for multiple instruction sets.
- A *virtual machine* is an interpreter for a bytecode intermediate language produced by languages such as Java and C#.
- 4- A *CISC machine* is typically a two-address machine with relatively few registers, several register classes, and variable-length instructions with complex addressing modes.
- A *RISC machine* is typically a three-address machine with many registers in which operations are done in registers.
- A *basic block* is a maximal sequence of consecutive three-address statements in which flow of control can only enter at the first statement of the block and leave at the last statement without halting or branching except possibly at the last statement in the basic block.
- A *flow graph* is a graphical representation of a program in which the nodes of the graph are basic blocks and the edges of the graph show how control can flow among the blocks.
- 4- A *loop* in a flow graph is a strongly connected region with a single entry point called the loop header.
- A *DAG* representation of a basic block is a directed acyclic graph in which the nodes of the DAG represent the statements within the block and each child of a node corresponds to the statement that is the last definition of an operand used in the statement.
- *Peephole optimizations* are local code-improving transformations that can be applied to a program, usually through a sliding window.

- \* *Instruction selection* can be done by a tree-rewriting process in which tree patterns corresponding to machine instructions are used to tile a syntax tree. We can associate costs with the tree-rewriting rules and apply dynamic programming to obtain an optimal tiling for useful classes of machines and expressions.
- 4- An *Ershov number* tells how many registers are needed to evaluate an expression without storing any temporaries.
- *Spill code* is an instruction sequence that stores a value in a register into memory in order to make room to hold another value in that register.

## 8.13 References for Chapter 8

Many of the techniques covered in this chapter have their origins in the earliest compilers. Ershov's labeling algorithm appeared in 1958 [7]. Sethi and Ullman [16] used this labeling in an algorithm that they prove generated optimal code for arithmetic expressions. Aho and Johnson [1] used dynamic programming to generate optimal code for expression trees on CISC machines. Hennessy and Patterson [12] has a good discussion on the evolution of CISC and RISC machine architectures and the tradeoffs involved in designing a good instruction set.

RISC architectures became popular after 1990, although their origins go back to computers like the CDC 6600, first delivered in 1964. Many of the computers designed before 1990 were CISC machines, but most of the general-purpose computers installed after 1990 are still CISC machines because they are based on the Intel 80x86 architecture and its descendants, such as the Pentium. The Burroughs B5000 delivered in 1963 was an early stack-based machine.

Many of the heuristics for code generation proposed in this chapter have been used in various compilers. Our strategy of allocating a fixed number of registers to hold variables for the duration of a loop was used in the implementation of Fortran H by Lowry and Medlock [13].

Efficient register allocation techniques have also been studied from the time of the earliest compilers. Graph coloring as a register-allocation technique was proposed by Cocke, Ershov [8], and Schwartz [15]. Many variants of graph-coloring algorithms have been proposed for register allocation. Our treatment of graph coloring follows Chaitin [3] [4]. Chow and Hennessy describe their priority-based coloring algorithm for register allocation in [5]. See [6] for a discussion of more recent graph-splitting and rewriting techniques for register allocation.

Lexical analyzer and parser generators spurred the development of pattern-directed instruction selection. Glanville and Graham [11] used LR-parser generation techniques for automated instruction selection. Table-driven code generators evolved into a variety of tree-pattern matching code-generation tools [14]. Aho, Ganapathi, and Tjiang [2] combined efficient tree-pattern matching

techniques with dynamic programming in the code generation tool *twig*. Fraser, Hanson, and Proebsting [10] further refined these ideas in their simple efficient code-generator generator.

1. Aho, A. V. and S. C. Johnson, "Optimal code generation for expression trees," *J. ACM* 23:3, pp. 488-501.
2. Aho, A. V., M. Ganapathi, and S. W. K. Tjiang, "Code generation using tree matching and dynamic programming," *ACM Trans. Programming Languages and Systems* 11:4 (1989), pp. 491-516.
3. Chaitin, G. J., M. A. Auslander, A. K. Chandra, J. Cocke, M. E. Hopkins, and P. W. Markstein, "Register allocation via coloring," *Computer Languages* 6:1 (1981), pp. 47-57.
4. Chaitin, G. J., "Register allocation and spilling via graph coloring," *ACM SIGPLAN Notices* 17:6 (1982), pp. 201-207.
5. Chow, F. and J. L. Hennessy, "The priority-based coloring approach to register allocation," *ACM Trans. Programming Languages and Systems* 12:4 (1990), pp. 501-536.
6. Cooper, K. D. and L. Torczon, *Engineering a Compiler*, Morgan Kaufmann, San Francisco CA, 2004.
7. Ershov, A. P., "On programming of arithmetic operations," *Comm. ACM* 1:8 (1958), pp. 3-6. Also, *Comm. ACM* 1:9 (1958), p. 16.
8. Ershov, A. P., *The Alpha Automatic Programming System*, Academic Press, New York, 1971.
9. Fischer, C. N. and R. J. LeBlanc, *Crafting a Compiler with C*, Benjamin-Cummings, Redwood City, CA, 1991.
10. Fraser, C. W., D. R. Hanson, and T. A. Proebsting, "Engineering a simple, efficient code generator generator," *ACM Letters on Programming Languages and Systems* 1:3 (1992), pp. 213-226.
11. Glanville, R. S. and S. L. Graham, "A new method for compiler code generation," *Conf. Rec. Fifth ACM Symposium on Principles of Programming Languages* (1978), pp. 231-240.
12. Hennessy, J. L. and D. A. Patterson, *Computer Architecture: A Quantitative Approach*, Third Edition, Morgan Kaufman, San Francisco, 2003.
13. Lowry, E. S. and C. W. Medlock, "Object code optimization," *Comm. ACM* 12:1 (1969), pp. 13-22.

14. Pelegri-Llopart, E. and S. L. Graham, "Optimal code generation for expressions trees: an application of BURS theory," *Conf. Rec. Fifteenth Annual ACM Symposium on Principles of Programming Languages* (1988), pp. 294-308.
15. Schwartz, J. T., *On Programming: An Interim Report on the SETL Project*, Technical Report, Courant Institute of Mathematical Sciences, New York, 1973.
16. Sethi, R. and J. D. Ullman, "The generation of optimal code for arithmetic expressions," *J. ACM* 17:4 (1970), pp. 715-728.



# Chapter 9

## Machine-Independent Optimizations

High-level language constructs can introduce substantial run-time overhead if we naively translate each construct independently into machine code. This chapter discusses how to eliminate many of these inefficiencies. Elimination of unnecessary instructions in object code, or the replacement of one sequence of instructions by a faster sequence of instructions that does the same thing is usually called "code improvement" or "code optimization."

*Local* code optimization (code improvement within a basic block) was introduced in Section 8.5. This chapter deals with *global* code optimization, where improvements take into account what happens across basic blocks. We begin in Section 9.1 with a discussion of the principal opportunities for code improvement.

Most global optimizations are based on *data-flow analyses*, which are algorithms to gather information about a program. The results of data-flow analyses all have the same form: for each instruction in the program, they specify some property that must hold every time that instruction is executed. The analyses differ in the properties they compute. For example, a constant-propagation analysis computes, for each point in the program, and for each variable used by the program, whether that variable has a unique constant value at that point. This information may be used to replace variable references by constant values, for instance. As another example, a liveness analysis determines, for each point in the program, whether the value held by a particular variable at that point is sure to be overwritten before it is read. If so, we do not need to preserve that value, either in a register or in a memory location.

We introduce data-flow analysis in Section 9.2, including several important examples of the kind of information we gather globally and then use to improve the code. Section 9.3 introduces the general idea of a data-flow framework, of which the data-flow analyses in Section 9.2 are special cases. We can use essentially the same algorithms for all these instances of data-flow analysis, and

we can measure the performance of these algorithms and show their correctness on all instances, as well. Section 9.4 is an example of the general framework that does more powerful analysis than the earlier examples. Then, in Section 9.5 we consider a powerful technique, called "partial redundancy elimination," for optimizing the placement of each expression evaluation in the program. The solution to this problem requires the solution of a variety of different data-flow problems.

In Section 9.6 we take up the discovery and analysis of loops in programs. The identification of loops leads to another family of algorithms for solving data-flow problems that is based on the hierarchical structure of the loops of a well-formed ("reducible") program. This approach to data-flow analysis is covered in Section 9.7. Finally, Section 9.8 uses hierarchical analysis to eliminate induction variables (essentially, variables that count the number of iterations around a loop). This code improvement is one of the most important we can make for programs written in commonly used programming languages.

## 9.1 The Principal Sources of Optimization

A compiler optimization must preserve the semantics of the original program. Except in very special circumstances, once a programmer chooses and implements a particular algorithm, the compiler cannot understand enough about the program to replace it with a substantially different and more efficient algorithm. A compiler knows only how to apply relatively low-level semantic transformations, using general facts such as algebraic identities like  $i + 0 = i$  or program semantics such as the fact that performing the same operation on the same values yields the same result.

### 9.1.1 Causes of Redundancy

There are many redundant operations in a typical program. Sometimes the redundancy is available at the source level. For instance, a programmer may find it more direct and convenient to recalculate some result, leaving it to the compiler to recognize that only one such calculation is necessary. But more often, the redundancy is a side effect of having written the program in a high-level language. In most languages (other than C or C++, where pointer arithmetic is allowed), programmers have no choice but to refer to elements of an array or fields in a structure through accesses like  $A[i][j]$  or  $X \text{ -+ } fl$ .

As a program is compiled, each of these high-level data-structure accesses expands into a number of low-level arithmetic operations, such as the computation of the location of the  $(i, j)$ th element of a matrix  $A$ . Accesses to the same data structure often share many common low-level operations. Programmers are not aware of these low-level operations and cannot eliminate the redundancies themselves. It is, in fact, preferable from a software-engineering perspective that programmers only access data elements by their high-level names; the

programs are easier to write and, more importantly, easier to understand and evolve. By having a compiler eliminate the redundancies, we get the best of both worlds: the programs are both efficient and easy to maintain.

### 9.1.2 A Running Example: Quicksort

In the following, we shall use a fragment of a sorting program called *quicksort* to illustrate several important code-improving transformations. The C program in Fig. 9.1 is derived from Sedgewick,<sup>1</sup> who discussed the hand-optimization of such a program. We shall not discuss all the subtle algorithmic aspects of this program here, for example, the fact that  $a[0]$  must contain the smallest of the sorted elements, and  $a[\max]$  the largest.

```

void quicksort(int m, int n)
    /* recursively sorts a[m] through a[n] */
{
    int i, j;
    int v, x;
    if (n <= m) return;
    /* fragment begins here */
    i = m - 1; j = n; v = a[n];
    while (1) i
        do i = i + 1; while (a[i] < v);
        do j = j - 1; while (a[j] > v);
        if (i >= j) break;
        x = a[i]; a[i] = a[j]; a[j] = x; /* swap a[i], a[j] */
    }
    x = a[i]; a[i] = a[n]; a[n] = x; /* swap a[i], a[n] */
    /* fragment ends here */
    quicksort(m, j); quicksort(i + 1, n);
}

```

Figure 9.1: C code for quicksort

Before we can optimize away the redundancies in address calculations, the address operations in a program first must be broken down into low-level arithmetic operations to expose the redundancies. In the rest of this chapter, we assume that the intermediate representation consists of three-address statements, where temporary variables are used to hold all the results of intermediate expressions. Intermediate code for the marked fragment of the program in Fig. 9.1 is shown in Fig. 9.2.

In this example we assume that integers occupy four bytes. The assignment  $x = a[i]$  is translated as in Section 6.4.4 into the two three-address statements

<sup>1</sup>R. Sedgewick, "Implementing Quicksort Programs," *Comm. ACM*, **21**, 1978, pp. 847-857.



(1)	$i = m-1$	(16)	$t7 = 4*i$
(2)	$j = n$	(17)	$t8 = 4*j$
(3)	$t1 = 4*n$	(18)	$t9 = a[t8]$
(4)	$v = a[t1]$	(19)	$a[t7] = t9$
(5)	$i = i+1$	(20)	$t10 = 4*j$
(6)	$t2 = 4*i$	(21)	$a[t10] = x$
(7)	$t3 = a[t2]$	(22)	goto (5)
(8)	if $t3 < v$ goto (5)	(23)	$t11 = 4*i$
(9)	$j = j-1$	(24)	$x = a[t11]$
(10)	$t4 = 4*j$	(25)	$t12 = 4*i$
(11)	$t5 = a[t4]$	(26)	$t13 = 4*n$
(12)	if $t5 > v$ goto (9)	(27)	$t14 = a[t13]$
(13)	if $i >= j$ goto (23)	(28)	$a[t12] = t14$
(14)	$t6 = 4*i$	(29)	$t15 = 4*n$
(15)	$x = a[t6]$	(30)	$a[t15] = x$

Figure 9.2: Three-address code for fragment in Fig. 9.1

```
t6 = 4*i
x = a[t6]
```

as shown in steps (14) and (15) of Fig. 9.2. Similarly,  $a[j] = x$  becomes

```
t10 = 4*j
a[t10] = x
```

in steps (20) and (21). Notice that every array access in the original program translates into a pair of steps, consisting of a multiplication and an array-subscripting operation. As a result, this short program fragment translates into a rather long sequence of three-address operations.

Figure 9.3 is the flow graph for the program in Fig. 9.2. Block  $B_1$  is the entry node. All conditional and unconditional jumps to statements in Fig. 9.2 have been replaced in Fig. 9.3 by jumps to the block of which the statements are leaders, as in Section 8.4. In Fig. 9.3, there are three loops. Blocks  $B_2$  and  $B_3$  are loops by themselves. Blocks  $B_4$ ,  $B_5$ ,  $B_6$  and  $B_7$  together form a loop, with  $B_4$  the only entry point.

### 9.1.3 Semantics-Preserving Transformations

There are a number of ways in which a compiler can improve a program without changing the function it computes. Common-subexpression elimination, copy propagation, dead-code elimination, and constant folding are common examples of such function-preserving (or *semantics-preserving*) transformations; we shall consider each in turn.

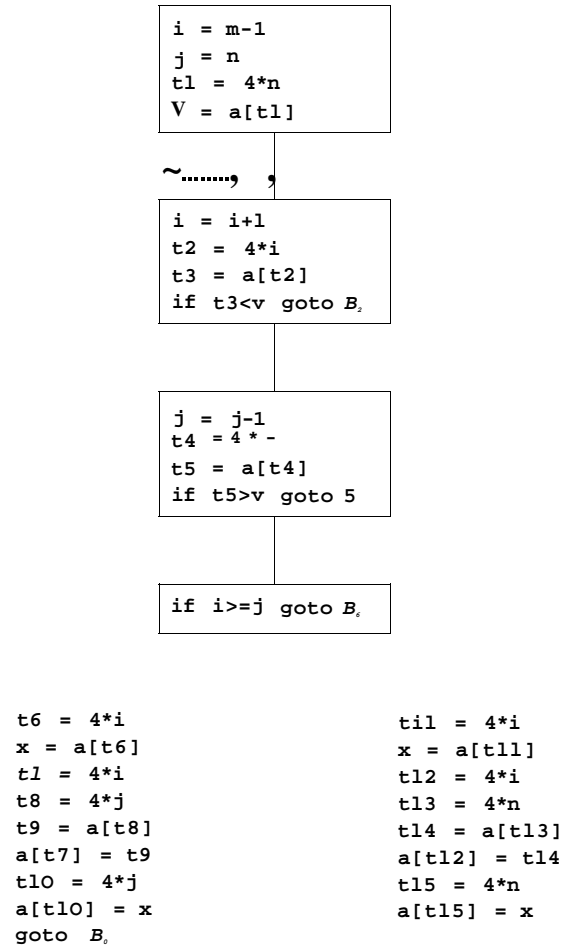

Figure 9.3: Flow graph for the quicksort fragment

Frequently, a program will include several calculations of the same value, such as an offset in an array. As mentioned in Section 9.1.2, some of these duplicate calculations cannot be avoided by the programmer because they lie below the level of detail accessible within the source language. For example, block **£5** shown in Fig. 9.4(a) recalculates  $4 * i$  and  $4 * j$ , although none of these calculations were requested explicitly by the programmer.

<pre> t6 = 4*i x = a[t6] t7 = 4*i t8 = 4*j t9 = a[t8] a[t7] = t9 t10 = 4*j a[t10] = x goto 5 </pre>	<pre> t6 = 4*i x = a[t6] t8 = 4*j t9 = a[t8] a[t6] = t9 a[t8] = x goto B, </pre>
---	--

(a) Before.

(b) After.

Figure 9.4: Local common-subexpression elimination

### 9.1.4 Global Common Subexpressions

An occurrence of an expression  $E$  is called a *common subexpression* if  $E$  was previously computed and the values of the variables in  $E$  have not changed since the previous computation. We avoid recomputing  $E$  if we can use its previously computed value; that is, the variable  $x$  to which the previous computation of  $E$  was assigned has not changed in the interim.<sup>2</sup>

Example 9.1: The assignments to  $t7$  and  $t10$  in Fig. 9.4(a) compute the common subexpressions  $4 * i$  and  $4 * j$ , respectively. These steps have been eliminated in Fig. 9.4(b), which uses  $t6$  instead of  $t7$  and  $t8$  instead of  $t10$ .

Example 9.2: Figure 9.5 shows the result of eliminating both global and local common subexpressions from blocks **f?5** and  $B_0$  in the flow graph of Fig. 9.3. We first discuss the transformation of  $B_0$ , and then mention some subtleties involving arrays.

After local common subexpressions are eliminated,  $B_0$  still evaluates  $4 * i$  and  $4 * j$ , as shown in Fig. 9.4(b). Both are common subexpressions; in particular, the three statements

<sup>2</sup>If  $x$  has changed, it may still be possible to reuse the computation of  $E$  if we assign its value to a new variable  $y$ , as well as to  $x$ , and use the value of  $y$  in place of a recomputation of  $E$ .

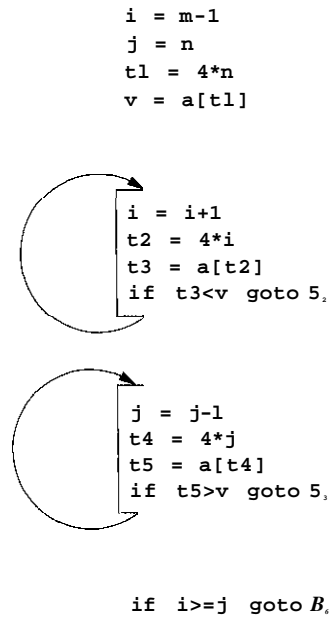

```

x = t3
a[t2] = t5
a[t4] = x
goto B,

x = t3
t14 = a[t1]
a[t2] = t14
a[t1] = x

```

Figure 9.5: and  $B_5$  after common-subexpression elimination

```

t8 = 4*j
t9 = a[t8]
a[t8] = x

```

in  $B_4$  can be replaced by

```

t9 = a[t4]
a[t4] = x

```

using  $t4$  computed in block  $B_5$ . In Fig. 9.5, observe that as control passes from the evaluation of  $4 * j$  in  $B_5$  to  $B_4$ , there is no change to  $j$  and no change to  $t4$ , so  $t4$  can be used if  $4 * j$  is needed.

Another common subexpression comes to light in  $B_4$  after  $t4$  replaces  $t8$ . The new expression  $a[t4]$  corresponds to the value of  $a[j]$  at the source level. Not only does  $j$  retain its value as control leaves  $B_5$  and then enters  $B_4$ , but

$a[j]$ , a value computed into a temporary  $t9$ , does too, because there are no assignments to elements of the array  $a$  in the interim. The statements

```
t9 = a[t4]
a[t6] = t9
```

in  $B_5$  therefore can be replaced by

```
a[t6] = t5
```

Analogously, the value assigned to  $x$  in block  $B_3$  of Fig. 9.4(b) is seen to be the same as the value assigned to  $t3$  in block  $B_2$ . Block  $B_3$  in Fig. 9.5 is the result of eliminating common subexpressions corresponding to the values of the source level expressions  $a[i]$  and  $a[j]$  from  $B_3$  in Fig. 9.4(b). A similar series of transformations has been done to  $BQ$  in Fig. 9.5.

The expression  $a[t1]$  in blocks  $B_1$  and  $BQ$  of Fig. 9.5 is *not* considered a common subexpression, although  $t1$  can be used in both places. After control leaves  $B_1$  and before it reaches  $BQ$ , it can go through  $B_3$ , where there are assignments to  $a$ . Hence,  $a[t1]$  may not have the same value on reaching  $BQ$  as it did on leaving  $B_1$ , and it is not safe to treat  $a[t1]$  as a common subexpression.

### 9.1.5 Copy Propagation

Block  $B_3$  in Fig. 9.5 can be further improved by eliminating  $x$ , using two new transformations. One concerns assignments of the form  $u = v$  called *copy statements*, or *copies* for short. Had we gone into more detail in Example 9.2, copies would have arisen much sooner, because the normal algorithm for eliminating common subexpressions introduces them, as do several other algorithms.

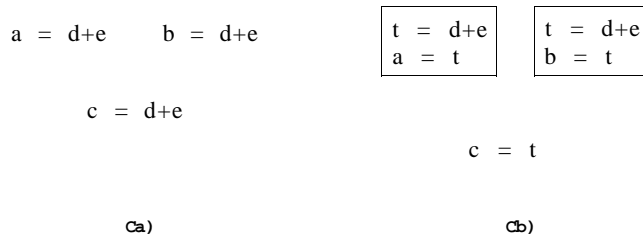

Figure 9.6: Copies introduced during common subexpression elimination

Example 9.3: In order to eliminate the common subexpression from the statement  $c = d+e$  in Fig. 9.6(a), we must use a new variable  $t$  to hold the value of  $d+e$ . The value of variable  $t$ , instead of that of the expression  $d+e$ , is assigned to  $c$  in Fig. 9.6(b). Since control may reach  $c = d+e$  either after the assignment to  $a$  or after the assignment to  $b$ , it would be incorrect to replace  $c = d+e$  by either  $c = a$  or by  $c = b$ . •

The idea behind the copy-propagation transformation is to use  $v$  for  $ii$ , wherever possible after the copy statement  $u = v$ . For example, the assignment  $x = t3$  in block  $B_5$  of Fig. 9.5 is a copy. Copy propagation applied to  $B_5$  yields the code in Fig. 9.7. This change may not appear to be an improvement, but, as we shall see in Section 9.1.6, it gives us the opportunity to eliminate the assignment to  $x$ .

```
x = t3
a[t2] = t5
a[t4] = t3
goto B5
```

Figure 9.7: Basic block  $B_5$  after copy propagation

### 9.1.6 Dead-Code Elimination

A variable is *live* at a point in a program if its value can be used subsequently; otherwise, it is *dead* at that point. A related idea is *dead* (or *useless*) *code* — statements that compute values that never get used. While the programmer is unlikely to introduce any dead code intentionally, it may appear as the result of previous transformations.

**Example 9.4:** Suppose `debug` is set to `TRUE` or `FALSE` at various points in the program, and used in statements like

```
if (debug) print ...
```

It may be possible for the compiler to deduce that each time the program reaches this statement, the value of `debug` is `FALSE`. Usually, it is because there is one particular statement

```
debug = FALSE
```

that must be the last assignment to `debug` prior to any tests of the value of `debug`, no matter what sequence of branches the program actually takes. If copy propagation replaces `debug` by `FALSE`, then the `print` statement is dead because it cannot be reached. We can eliminate both the test and the `print` operation from the object code. More generally, deducing at compile time that the value of an expression is a constant and using the constant instead is known as *constant folding*. •

One advantage of copy propagation is that it often turns the copy statement into dead code. For example, copy propagation followed by dead-code elimination removes the assignment to  $x$  and transforms the code in Fig 9.7 into

```

a[t2] = t5
a[t4] = t3
goto B,

```

This code is a further improvement of block  $B_i$  in Fig. 9.5.

### 9.1.7 Code Motion

Loops are a very important place for optimizations, especially the inner loops where programs tend to spend the bulk of their time. The running time of a program may be improved if we decrease the number of instructions in an inner loop, even if we increase the amount of code outside that loop.

An important modification that decreases the amount of code in a loop is *code motion*. This transformation takes an expression that yields the same result independent of the number of times a loop is executed (a *loop-invariant computation*) and evaluates the expression before the loop. Note that the notion "before the loop" assumes the existence of an entry for the loop, that is, one basic block to which all jumps from outside the loop go (see Section 8.4.5).

**Example 9.5:** Evaluation of  $limit - 2$  is a loop-invariant computation in the following while-statement:

```

while (i <= limit-2) /* statement does not change limit */

```

Code motion will result in the equivalent code

```

t = limit-2
while (i <= t) /* statement does not change limit or t */

```

Now, the computation of  $limit - 2$  is performed once, before we enter the loop. Previously, there would be  $n + 1$  calculations of  $limit - 2$  if we iterated the body of the loop  $n$  times. •

### 9.1.8 Induction Variables and Reduction in Strength

Another important optimization is to find induction variables in loops and optimize their computation. A variable  $x$  is said to be an "induction variable" if there is a positive or negative constant  $c$  such that each time  $x$  is assigned, its value increases by  $c$ . For instance,  $i$  and  $tl$  are induction variables in the loop containing  $B_i$  of Fig. 9.5. Induction variables can be computed with a single increment (addition or subtraction) per loop iteration. The transformation of replacing an expensive operation, such as multiplication, by a cheaper one, such as addition, is known as *strength reduction*. But induction variables not only allow us sometimes to perform a strength reduction; often it is possible to eliminate all but one of a group of induction variables whose values remain in lock step as we go around the loop.

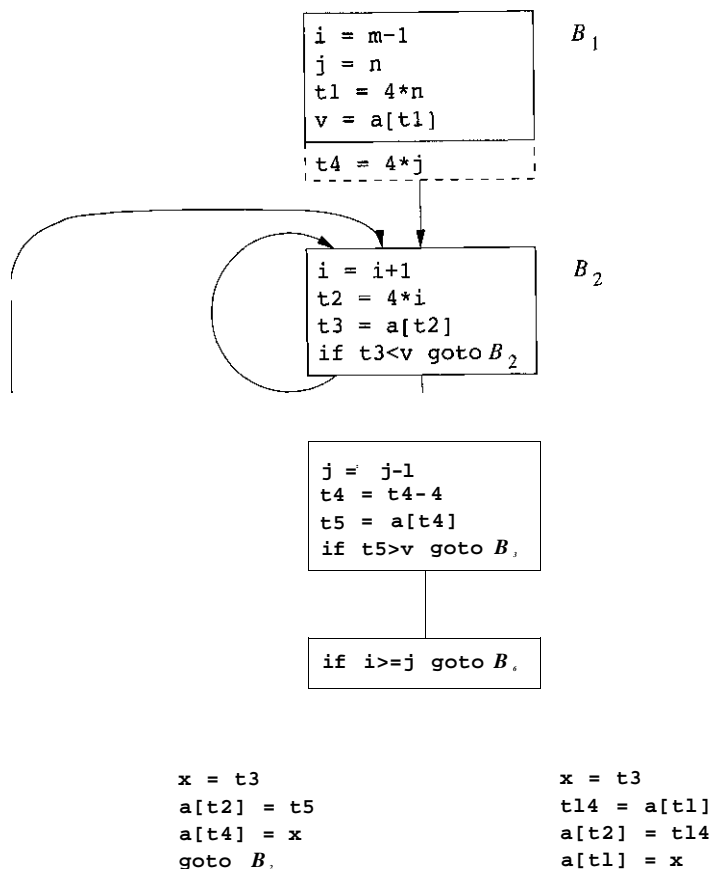
Figure 9.8: Strength reduction applied to  $4 * j$  in block  $S_3$ 

When processing loops, it is useful to work "inside-out"; that is, we shall start with the inner loops and proceed to progressively larger, surrounding loops. Thus, we shall see how this optimization applies to our quicksort example by beginning with one of the innermost loops:  $B_1$  by itself. Note that the values of  $j$  and  $t4$  remain in lock step; every time the value of  $j$  decreases by 1, the value of  $t4$  decreases by 4, because  $4 * j$  is assigned to  $t4$ . These variables,  $j$  and  $t4$ , thus form a good example of a pair of induction variables.

When there are two or more induction variables in a loop, it may be possible to get rid of all but one. For the inner loop of  $B_1$  in Fig. 9.5, we cannot get rid of either  $j$  or  $t4$  completely;  $t4$  is used in  $B_1$  and  $j$  is used in  $B_{\pm}$ . However, we can illustrate reduction in strength and a part of the process of induction-variable elimination. Eventually,  $j$  will be eliminated when the outer loop consisting of blocks  $B_2, B_3, B_{\pm}$  and  $B_5$  is considered.



Example 9.6: As the relationship  $t4 = 4 * j$  surely holds after assignment to  $t4$  in Fig. 9.5, and  $t4$  is not changed elsewhere in the inner loop around  $B3$ , it follows that just after the statement  $j = j - 1$  the relationship  $t4 = 4 * j + 4$  must hold. We may therefore replace the assignment  $t4 = 4 * j$  by  $t4 = t4 - 4$ . The only problem is that  $t4$  does not have a value when we enter block  $B3$  for the first time.

Since we must maintain the relationship  $t4 = 4 * j$  on entry to the block  $B3$ , we place an initialization of  $t4$  at the end of the block where  $j$  itself is initialized, shown by the dashed addition to block  $B_1$  in Fig. 9.8. Although we have added one more instruction, which is executed once in block  $B_i$ , the replacement of a multiplication by a subtraction will speed up the object code if multiplication takes more time than addition or subtraction, as is the case on many machines.

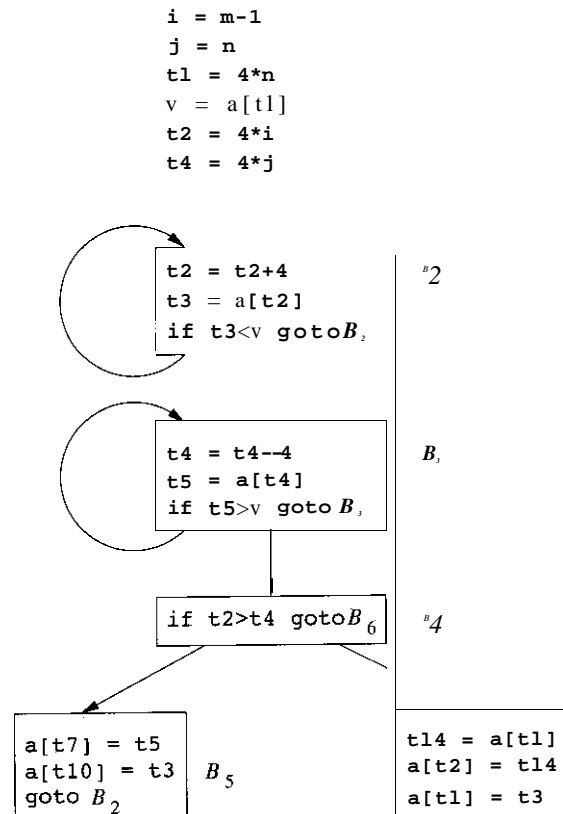

Figure 9.9: Flow graph after induction-variable elimination

We conclude this section with one more instance of induction-variable elim-

ination. This example treats  $i$  and  $j$  in the context of the outer loop containing  $B_2$ ,  $B_3$ ,  $B_4$ , and  $B_5$ .

Example 9.7: After reduction in strength is applied to the inner loops around  $B_2$  and  $B_3$ , the only use of  $i$  and  $j$  is to determine the outcome of the test in block  $B_4$ . We know that the values of  $i$  and  $t2$  satisfy the relationship  $t2 = 4*i$ , while those of  $j$  and  $t4$  satisfy the relationship  $t4 = 4*j$ . Thus, the test  $t2 > t4$  can substitute for  $i > j$ . Once this replacement is made,  $i$  in block  $B_2$  and  $j$  in block  $B_3$  become dead variables, and the assignments to them in these blocks become dead code that can be eliminated. The resulting flow graph is shown in Fig. 9.9. •

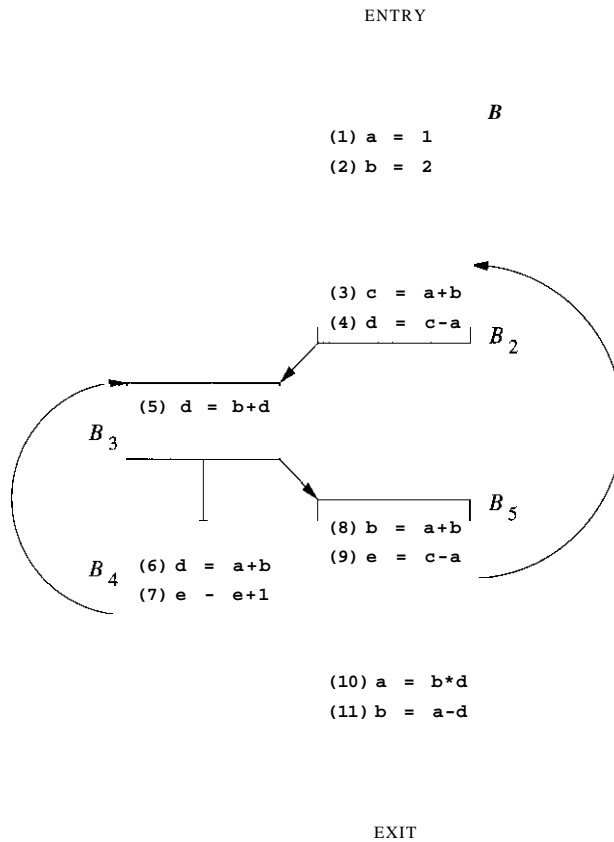

Figure 9.10: Flow graph for Exercise 9.1.1

The code-improving transformations we have discussed have been effective. In Fig. 9.9, the numbers of instructions in blocks  $B_2$  and  $B_3$  have been reduced from 4 to 3, compared with the original flow graph in Fig. 9.3. In  $B_4$ , the number

has been reduced from 9 to 3, and in  $B_6$  from 8 to 3. True,  $B_i$  has grown from four instructions to six, but  $B_i$  is executed only once in the fragment, so the total running time is barely affected by the size of  $B_i$ .

### 9.1.9 Exercises for Section 9.1

**Exercise 9.1.1:** For the flow graph in Fig. 9.10:

- a) Identify the loops of the flow graph.
- b) Statements (1) and (2) in  $B_i$  are both copy statements, in which  $a$  and  $b$  are given constant values. For which uses of  $a$  and  $b$  can we perform copy propagation and replace these uses of variables by uses of a constant? Do so, wherever possible.
- c) Identify any global common subexpressions for each loop.
- d) Identify any induction variables for each loop. Be sure to take into account any constants introduced in (b).
- e) Identify any loop-invariant computations for each loop.

**Exercise 9.1.2:** Apply the transformations of this section to the flow graph of Fig. 8.9.

**Exercise 9.1.3:** Apply the transformations of this section to your flow graphs from (a) Exercise 8.4.1; (b) Exercise 8.4.2.

**Exercise 9.1.4:** In Fig. 9.11 is intermediate code to compute the dot product of two vectors  $A$  and  $B$ . Optimize this code by eliminating common subexpressions, performing reduction in strength on induction variables, and eliminating all the induction variables you can.

```

dp = 0.
i = 0
L: t1 = i*8
   t2 = A[t1]
   t3 = i*8
   t4 = B[t3]
   t5 = t2*t4
   dp = dp+t5
   i = i+1
   if i<n goto L

```

Figure 9.11: Intermediate code to compute the dot product

## 9.2 Introduction to Data-Flow Analysis

All the optimizations introduced in Section 9.1 depend on *data-flow analysis*. "Data-flow analysis" refers to a body of techniques that derive information about the flow of data along program execution paths. For example, one way to implement global common subexpression elimination requires us to determine whether two textually identical expressions evaluate to the same value along any possible execution path of the program. As another example, if the result of an assignment is not used along any subsequent execution path, then we can eliminate the assignment as dead code. These and many other important questions can be answered by data-flow analysis.

### 9.2.1 The Data-Flow Abstraction

Following Section 1.6.2, the execution of a program can be viewed as a series of transformations of the program state, which consists of the values of all the variables in the program, including those associated with stack frames below the top of the run-time stack. Each execution of an intermediate-code statement transforms an input state to a new output state. The input state is associated with the *program point before* the statement and the output state is associated with the *program point after* the statement.

When we analyze the behavior of a program, we must consider all the possible sequences of program points ("paths") through a flow graph that the program execution can take. We then extract, from the possible program states at each point, the information we need for the particular data-flow analysis problem we want to solve. In more complex analyses, we must consider paths that jump among the flow graphs for various procedures, as calls and returns are executed. However, to begin our study, we shall concentrate on the paths through a single flow graph for a single procedure.

Let us see what the flow graph tells us about the possible execution paths.

- Within one basic block, the program point after a statement is the same as the program point before the next statement.
- If there is an edge from block  $B_i$  to block  $B_j$ , then the program point after the last statement of  $B_i$  may be followed immediately by the program point before the first statement of  $B_j$ .

Thus, we may define an *execution path* (or just *path*) from point  $p_i$  to point  $p_n$  to be a sequence of points  $p_i, p_2, \dots, p_n$  such that for each  $i = 1, 2, \dots, n - 1$ , either

1.  $p_i$  is the point immediately preceding a statement and  $p_{i+1}$  is the point immediately following that same statement, or
2.  $p_i$  is the end of some block and  $p_{i+1}$  is the beginning of a successor block.

In general, there is an infinite number of possible execution paths through a program, and there is no finite upper bound on the length of an execution path. Program analyses summarize all the possible program states that can occur at a point in the program with a finite set of facts. Different analyses may choose to abstract out different information, and in general, no analysis is necessarily a perfect representation of the state.

**Example 9.8:** Even the simple program in Fig. 9.12 describes an unbounded number of execution paths. Not entering the loop at all, the shortest complete execution path consists of the program points (1,2,3,4,9). The next shortest path executes one iteration of the loop and consists of the points (1,2,3,4,5,6,7,8,3,4,9). We know that, for example, the first time program point (5) is executed, the value of  $a$  is 1 due to definition  $d_1$ . We say that  $d_1$  reaches point (5) in the first iteration. In subsequent iterations,  $d_3$  reaches point (5) and the value of  $a$  is 243.

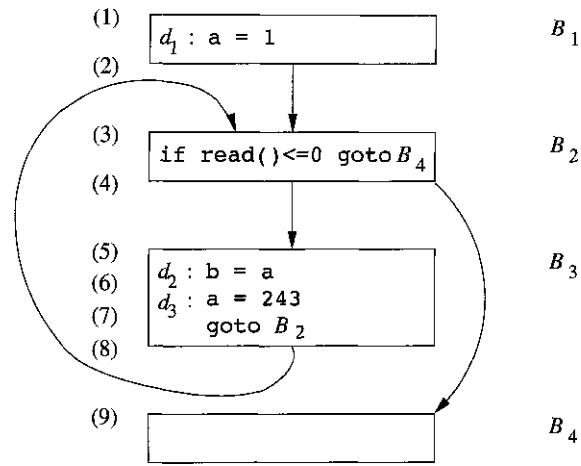

Figure 9.12: Example program illustrating the data-flow abstraction

In general, it is not possible to keep track of all the program states for all possible paths. In data-flow analysis, we do not distinguish among the paths taken to reach a program point. Moreover, we do not keep track of entire states; rather, we abstract out certain details, keeping only the data we need for the purpose of the analysis. Two examples will illustrate how the same program states may lead to different information abstracted at a point.

1. To help users debug their programs, we may wish to find out what are all the values a variable may have at a program point, and where these values may be defined. For instance, we may summarize all the program states at point (5) by saying that the value of  $a$  is one of  $\{1, 243\}$ , and that it may be defined by one of  $\{d_1, d_3\}$ . The definitions that *may* reach a program point along some path are known as *reaching definitions*.

2. Suppose, instead, we are interested in implementing constant folding. If a use of the variable  $x$  is reached by only one definition, and that definition assigns a constant to  $x$ , then we can simply replace  $x$  by the constant. If, on the other hand, several definitions of  $x$  may reach a single program point, then we cannot perform constant folding on  $x$ . Thus, for constant folding we wish to find those definitions that are the unique definition of their variable to reach a given program point, no matter which execution path is taken. For point (5) of Fig. 9.12, there is no definition that *must* be the definition of  $a$  at that point, so this set is empty for  $a$  at point (5). Even if a variable has a unique definition at a point, that definition must assign a constant to the variable. Thus, we may simply describe certain variables as "not a constant," instead of collecting all their possible values or all their possible definitions.

Thus, we see that the same information may be summarized differently, depending on the purpose of the analysis. •

## 9.2.2 The Data-Flow Analysis Schema

In each application of data-flow analysis, we associate with every program point a *data-flow value* that represents an abstraction of the set of all possible program states that can be observed for that point. The set of possible data-flow values is the *domain* for this application. For example, the domain of data-flow values for reaching definitions is the set of all subsets of definitions in the program. A particular data-flow value is a set of definitions, and we want to associate with each point in the program the exact set of definitions that can reach that point. As discussed above, the choice of abstraction depends on the goal of the analysis; to be efficient, we only keep track of information that is relevant.

We denote the data-flow values before and after each statement  $s$  by  $\text{IN}[S]$  and  $\text{OUT}[s]$ , respectively. The *data-flow problem* is to find a solution to a set of constraints on the  $\text{IN}[S]$ 's and  $\text{OUT}[s]$ 's, for all statements  $s$ . There are two sets of constraints: those based on the semantics of the statements ("transfer functions") and those based on the flow of control.

### Transfer Functions

The data-flow values before and after a statement are constrained by the semantics of the statement. For example, suppose our data-flow analysis involves determining the constant value of variables at points. If variable  $a$  has value  $v$  before executing statement  $\mathbf{b} = a$ , then both  $a$  and  $b$  will have the value  $v$  after the statement. This relationship between the data-flow values before and after the assignment statement is known as a *transfer function*.

Transfer functions come in two flavors: information may propagate forward along execution paths, or it may flow backwards up the execution paths. In a forward-flow problem, the transfer function of a statement  $s$ , which we shall

usually denote  $f_s$  takes the data-flow value before the statement and produces a new data-flow value after the statement. That is,

$$\text{OUT}[a] = f_s(\text{IN}[a]).$$

Conversely, in a backward-flow problem, the transfer function  $f_s$  for statement  $s$  converts a data-flow value after the statement to a new data-flow value before the statement. That is,

$$\text{IN}[s] = f_s(\text{OUT}[s]).$$

### Control-Flow Constraints

The second set of constraints on data-flow values is derived from the flow of control. Within a basic block, control flow is simple. If a block  $B$  consists of statements  $s_1, s_2, \dots, s_n$  in that order, then the control-flow value out of  $s_i$  is the same as the control-flow value into  $s_{i+1}$ . That is,

$$\text{IN}[s_{i+1}] = \text{OUT}[s_i], \text{ for all } i = 1, 2, \dots, n - 1.$$

However, control-flow edges between basic blocks create more complex constraints between the last statement of one basic block and the first statement of the following block. For example, if we are interested in collecting all the definitions that may reach a program point, then the set of definitions reaching the leader statement of a basic block is the union of the definitions after the last statements of each of the predecessor blocks. The next section gives the details of how data flows among the blocks.

### 9.2.3 Data-Flow Schemas on Basic Blocks

While a data-flow schema technically involves data-flow values at each point in the program, we can save time and space by recognizing that what goes on inside a block is usually quite simple. Control flows from the beginning to the end of the block, without interruption or branching. Thus, we can restate the schema in terms of data-flow values entering and leaving the blocks. We denote the data-flow values immediately before and immediately after each basic block  $B$  by  $\text{IN}[B]$  and  $\text{OUT}[B]$ , respectively. The constraints involving  $\text{IN}[B]$  and  $\text{OUT}[B]$  can be derived from those involving  $\text{IN}[s]$  and  $\text{OUT}[s]$  for the various statements  $s$  in  $B$  as follows.

Suppose block  $B$  consists of statements  $s_1, \dots, s_n$  in that order. If  $s_1$  is the first statement of basic block  $B$ , then  $\text{IN}[B] = \text{IN}[s_1]$ . Similarly, if  $s_n$  is the last statement of basic block  $B$ , then  $\text{OUT}[B] = \text{OUT}[s_n]$ . The transfer function of a basic block  $B$ , which we denote  $f_B$  can be derived by composing the transfer functions of the statements in the block. That is, let  $f_s$  be the transfer function of statement  $s$ . Then  $f_B = f_{s_1} \circ \dots \circ f_{s_n}$ . The relationship between the beginning and end of the block is

$$\text{OUT}[B] = f_B(\text{IN}[B]).$$

The constraints due to control flow between basic blocks can easily be rewritten by substituting  $IN[B]$  and  $OVT[B]$  for  $IN[S1]$  and  $OUT[s,,]$ , respectively. For instance, if data-flow values are information about the sets of constants that *may* be assigned to a variable, then we have a forward-flow problem in which

$$IN[B] = \bigcup_{P \text{ a predecessor of } B} OUT[P].$$

When the data-flow is backwards as we shall soon see in live-variable analysis, the equations are similar, but with the roles of the IN's and OUT's reversed. That is,

$$IN[B] = \bigcup_{S \text{ a successor of } B} OUT[S].$$

Unlike linear arithmetic equations, the data-flow equations usually do not have a unique solution. Our goal is to find the most "precise" solution that satisfies the two sets of constraints: control-flow and transfer constraints. That is, we need a solution that encourages valid code improvements, but does not justify unsafe transformations — those that change what the program computes. This issue is discussed briefly in the box on "Conservatism" and more extensively in Section 9.3.4. In the following subsections, we discuss some of the most important examples of problems that can be solved by data-flow analysis.

### 9.2.4 Reaching Definitions

"Reaching definitions" is one of the most common and useful data-flow schemas. By knowing where in a program each variable  $x$  may have been defined when control reaches each point  $p$ , we can determine many things about  $x$ . For just two examples, a compiler then knows whether  $x$  is a constant at point  $p$ , and a debugger can tell whether it is possible for  $x$  to be an undefined variable, should  $x$  be used at  $p$ .

We say a definition  $d$  *reaches* a point  $p$  if there is a path from the point immediately following  $d$  to  $p$ , such that  $d$  is not "killed" along that path. We *kill* a definition of a variable  $x$  if there is any other definition of  $x$  anywhere along the path.<sup>3</sup> Intuitively, if a definition  $d$  of some variable  $x$  reaches point  $p$ , then  $d$  might be the place at which the value of  $x$  used at  $p$  was last defined.

A definition of a variable  $x$  is a statement that assigns, or may assign, a value to  $x$ . Procedure parameters, array accesses, and indirect references all may have aliases, and it is not easy to tell if a statement is referring to a particular variable  $x$ . Program analysis must be conservative; if we do not

<sup>3</sup>Note that the path may have loops, so we could come to another occurrence of  $d$  along the path, which does not "kill"  $d$ .



## Detecting Possible Uses Before Definition

Here is how we use a solution to the reaching-definitions problem to detect uses before definition. The trick is to introduce a dummy definition for each variable  $x$  in the entry to the flow graph. If the dummy definition of  $x$  reaches a point  $p$  where  $x$  might be used, then there might be an opportunity to use  $x$  before definition. Note that we can never be absolutely certain that the program has a bug, since there may be some reason, possibly involving a complex logical argument, why the path along which  $p$  is reached without a real definition of  $x$  can never be taken.

know whether a statement  $s$  is assigning a value to  $x$ , we must assume that it *may* assign to it; that is, variable  $x$  after statement  $s$  may have either its original value before  $s$  or the new value created by  $s$ . For the sake of simplicity, the rest of the chapter assumes that we are dealing only with variables that have no aliases. This class of variables includes all local scalar variables in most languages; in the case of C and C++, local variables whose addresses have been computed at some point are excluded.

**Example 9.9:** Shown in Fig. 9.13 is a flow graph with seven definitions. Let us focus on the definitions reaching block  $B_2$ . All the definitions in block  $B_1$  reach the beginning of block  $B_2$ . The definition  $d_3: j = j - 1$  in block  $B_2$  also reaches the beginning of block  $B_2$ , because no other definitions of  $j$  can be found in the loop leading back to  $B_2$ . This definition, however, kills the definition  $d_4: j = n$ , preventing it from reaching  $B_2$  or  $J_3$ . The statement  $d_5: i = i + 1$  in  $B_2$  does not reach the beginning of  $B_2$  though, because the variable  $i$  is always redefined by  $d_6: i = u_3$ . Finally, the definition  $d_7: a = u_2$  also reaches the beginning of block  $B_2$ .

By defining reaching definitions as we have, we sometimes allow inaccuracies. However, they are all in the "safe," or "conservative," direction. For example, notice our assumption that all edges of a flow graph can be traversed. This assumption may not be true in practice. For example, for no values of  $a$  and  $b$  can the flow of control actually reach *statement 2* in the following program fragment:

```
if (a == b) statement 1; else if (a == b) statement 2;
```

To decide in general whether each path in a flow graph can be taken is an undecidable problem. Thus, we simply assume that every path in the flow graph can be followed in some execution of the program. In most applications of reaching definitions, it is conservative to assume that a definition can reach a point even if it might not. Thus, we may allow paths that are never be traversed in any execution of the program, and we may allow definitions to pass through ambiguous definitions of the same variable safely.

## Conservatism in Data-Flow Analysis

Since all data-flow schemas compute approximations to the ground truth (as defined by all possible execution paths of the program), we are obliged to assure that any errors are in the "safe" direction. A policy decision is *safe* (or *conservative*) if it never allows us to change what the program computes. Safe policies may, unfortunately, cause us to miss some code improvements that would retain the meaning of the program, but in essentially all code optimizations there is no safe policy that misses nothing. It would generally be unacceptable to use an unsafe policy — one that sped up the code at the expense of changing what the program computes.

Thus, when designing a data-flow schema, we must be conscious of how the information will be used, and make sure that any approximations we make are in the "conservative" or "safe" direction. Each schema and application must be considered independently. For instance, if we use reaching definitions for constant folding, it is safe to think a definition reaches when it doesn't (we might think  $x$  is not a constant, when in fact it is and could have been folded), but not safe to think a definition doesn't reach when it does (we might replace  $x$  by a constant, when the program would at times have a value for  $x$  other than that constant).

### Transfer Equations for Reaching Definitions

We shall now set up the constraints for the reaching definitions problem. We start by examining the details of a single statement. Consider a definition

$$\mathbf{ri}: u = v+w$$

Here, and frequently in what follows,  $+$  is used as a generic binary operator.

This statement "generates" a definition  $d$  of variable  $u$  and "kills" all the other definitions in the program that define variable  $u$ , while leaving the remaining incoming definitions unaffected. The transfer function of definition  $d$  thus can be expressed as

$$fd(x) = gen_d \cup (x - kill_d) \tag{9.1}$$

where  $gen_d = \{d\}$ , the set of definitions generated by the statement, and  $kill_d$  is the set of all other definitions of  $u$  in the program.

As discussed in Section 9.2.2, the transfer function of a basic block can be found by composing the transfer functions of the statements contained therein. The composition of functions of the form (9.1), which we shall refer to as "*gen-kill form*," is also of that form, as we can see as follows. Suppose there are two functions  $f_1(x) = gen_1 \cup (x - kill_1)$  and  $f_2(x) = gen_2 \cup (x - kill_2)$ . Then

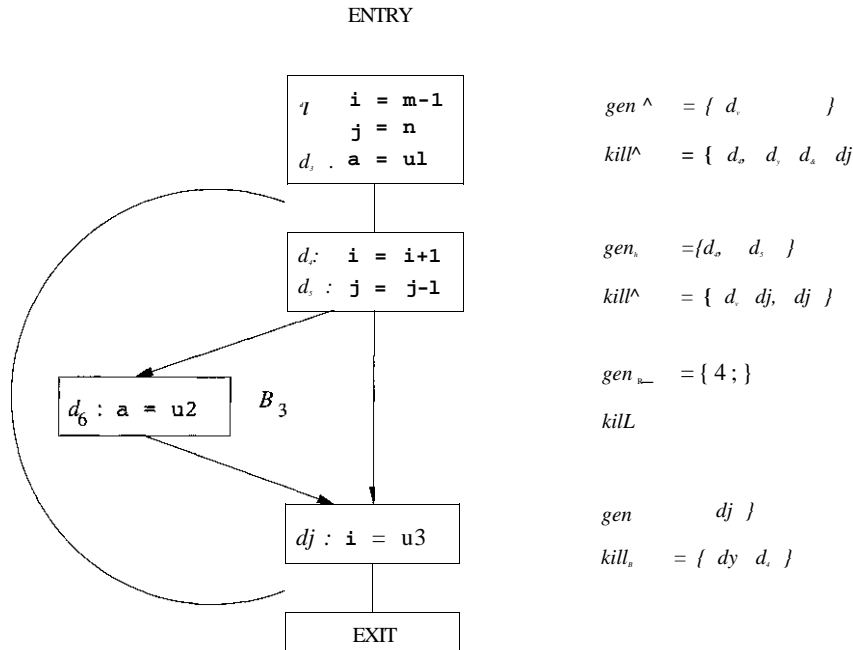

Figure 9.13: Flow graph for illustrating reaching definitions

$$\begin{aligned} M(iO) &= gen_s \cup (gen_i \cup (x - kill) - kill) \\ &= (gen_s \cup (gen_i - kill_s)) \cup (x - (kill \cup kill_s)) \end{aligned}$$

This rule extends to a block consisting of any number of statements. Suppose block  $B$  has  $n$  statements, with transfer functions  $f_i(x) = gen_i \cup (x - kill)$  for  $i = 1, 2, \dots, n$ . Then the transfer function for block  $B$  may be written as:

$$!B(X) = gen_n \cup (x - kills),$$

where

$$kills = kill_1 \cup kill_2 \cup \dots \cup kill_n$$

and

$$\begin{aligned} gen_s &= gen_n \cup (gen_{n-1} - kill_n) \cup (gen_{n-2} - kill_{n-1} - kill_n) \cup \\ &\quad \dots \cup (gen_1 - kill_2 - kill_3 - \dots - kill_n) \end{aligned}$$

Thus, like a statement, a basic block also generates a set of definitions and kills a set of definitions. The *gen* set contains all the definitions inside the block that are "visible" immediately after the block — we refer to them as *downwards exposed*. A definition is downwards exposed in a basic block only if it is not "killed" by a subsequent definition to the same variable inside the same basic block. A basic block's *kill* set is simply the union of all the definitions killed by the individual statements. Notice that a definition may appear in both the *gen* and *kill* set of a basic block. If so, the fact that it is in *gen* takes precedence, because in *gen-kill* form, the *kill* set is applied before the *gen* set.

**Example 9.10:** The *gen* set for the basic block

$$\begin{array}{ll} d \setminus & \mathbf{a} = 3 \\ d_2 & \mathbf{a} = 4 \end{array}$$

is  $\{d_2\}$  since  $d \setminus$  is not downwards exposed. The *kill* set contains both  $d \setminus$  and  $d_2$ , since  $d \setminus$  kills  $d_2$ , and vice versa. Nonetheless, since the subtraction of the *kill* set precedes the union operation with the *gen* set, the result of the transfer function for this block always includes definition  $d_2$ . •

### Control-Flow Equations

Next, we consider the set of constraints derived from the control flow between basic blocks. Since a definition reaches a program point as long as there exists at least one path along which the definition reaches,  $\text{OUT}[P] \subseteq \text{IN}[B]$  whenever there is a control-flow edge from  $P$  to  $B$ . However, since a definition cannot reach a point unless there is a path along which it reaches,  $\text{w}[B]$  needs to be no larger than the union of the reaching definitions of all the predecessor blocks. That is, it is safe to assume

$$\text{IN}[B] = \bigcup_{P \text{ a predecessor of } B} \text{OUT}[P]$$

We refer to union as the *meet operator* for reaching definitions. In any data-flow schema, the meet operator is the one we use to create a summary of the contributions from different paths at the confluence of those paths.

### Iterative Algorithm for Reaching Definitions

We assume that every control-flow graph has two empty basic blocks, an **ENTRY** node, which represents the starting point of the graph, and an **EXIT** node to which all exits out of the graph go. Since no definitions reach the beginning of the graph, the transfer function for the **ENTRY** block is a simple constant function that returns  $\emptyset$  as an answer. That is,  $\text{OUT}[\text{ENTRY}] = \emptyset$ .

The reaching definitions problem is defined by the following equations:

$$\text{OUT}[\text{ENTRY}] = \emptyset$$

and for all basic blocks  $B$  other than **ENTRY**,

$$OUT[B] = gen_U \cup (w[B] \text{ kills})$$

$$m[B] = \bigcup_{P \text{ a predecessor of } B} OUT_P.$$

These equations can be solved using the following algorithm. The result of the algorithm is the *least fixedpoint* of the equations, i.e., the solution whose assigned values to the **IN**'s and **OUT**'s is contained in the corresponding values for any other solution to the equations. The result of the algorithm below is acceptable, since any definition in one of the sets **IN** or **OUT** surely must reach the point described. It is a desirable solution, since it does not include any definitions that we can be sure do not reach.

Algorithm 9.11: Reaching definitions.

**INPUT:** A flow graph for which *kills* and *gen<sub>u</sub>* have been computed for each block  $B$ .

**OUTPUT:** **IN**[ $B$ ] and **OUT**[ $B$ ], the set of definitions reaching the entry and exit of each block  $B$  of the flow graph.

**METHOD:** We use an iterative approach, in which we start with the "estimate"  $OUT[B] = 0$  for all  $B$  and converge to the desired values of **IN** and **OUT**. As we must iterate until the **IN**'s (and hence the **OUT**'s) converge, we could use a boolean variable *change* to record, on each pass through the blocks, whether any **OUT** has changed. However, in this and in similar algorithms described later, we assume that the exact mechanism for keeping track of changes is understood, and we elide those details.

The algorithm is sketched in Fig. 9.14. The first two lines initialize certain data-flow values.<sup>4</sup> Line (3) starts the loop in which we iterate until convergence, and the inner loop of lines (4) through (6) applies the data-flow equations to every block other than the entry. •

Intuitively, Algorithm 9.11 propagates definitions as far as they will go without being killed, thus simulating all possible executions of the program. Algorithm 9.11 will eventually halt, because for every  $B$ , **OUT**[ $B$ ] never shrinks; once a definition is added, it stays there forever. (See Exercise 9.2.6.) Since the set of all definitions is finite, eventually there must be a pass of the while-loop during which nothing is added to any **OUT**, and the algorithm then terminates. We are safe terminating then because if the **OUT**'s have not changed, the **IN**'s will

<sup>4</sup>The observant reader will notice that we could easily combine lines (1) and (2). However, in similar data-flow algorithms, it may be necessary to initialize the entry or exit node differently from the way we initialize the other nodes. Thus, we follow a pattern in all iterative algorithms of applying a "boundary condition" like line (1) separately from the initialization of line (2).

```

1)  OUT[ENTRY] = 0;
2)  for (each basic block B other than ENTRY) OUT[B] = 0;
3)  while (changes to any OUT occur)
4)      for (each basic block B other than ENTRY) {
5)          IN[£] = UP a predecessor of B 0|J[P]
6)          OUT[S] = gens U (IN[S] - kills)
      }

```

Figure 9.14: Iterative algorithm to compute reaching definitions

not change on the next pass. And, if the **IN'S** do not change, the **OUT's** cannot, so on all subsequent passes there can be no changes.

The number of nodes in the flow graph is an upper bound on the number of times around the while-loop. The reason is that if a definition reaches a point, it can do so along a cycle-free path, and the number of nodes in a flow graph is an upper bound on the number of nodes in a cycle-free path. Each time around the while-loop, each definition progresses by at least one node along the path in question, and it often progresses by more than one node, depending on the order in which the nodes are visited.

In fact, if we properly order the blocks in the for-loop of line (5), there is empirical evidence that the average number of iterations of the while-loop is under 5 (see Section 9.6.7). Since sets of definitions can be represented by bit vectors, and the operations on these sets can be implemented by logical operations on the bit vectors, Algorithm 9.11 is surprisingly efficient in practice.

**Example 9.12:** We shall represent the seven definitions  $d_1, d_2, \dots, d_7$  in the flow graph of Fig. 9.13 by bit vectors, where bit  $i$  from the left represents definition  $d_i$ . The union of sets is computed by taking the logical OR of the corresponding bit vectors. The difference of two sets  $S - T$  is computed by complementing the bit vector of  $T$ , and then taking the logical AND of that complement, with the bit vector for  $S$ .

Shown in the table of Fig. 9.15 are the values taken on by the **IN** and **OUT** sets in Algorithm 9.11. The initial values, indicated by a superscript 0, as in  $\text{OUTfS}^0$ , are assigned, by the loop of line (2) of Fig. 9.14. They are each the empty set, represented by bit vector 000 0000. The values of subsequent passes of the algorithm are also indicated by superscripts, and labeled **IN** [I?]' and **OUTfS**]' for the first pass and  $m[Bf$  and  $\text{OUT[S}]'$  for the second.

Suppose the for-loop of lines (4) through (6) is executed with  $B$  taking on the values

$B \setminus, B < i, B3, S4, \text{EXIT}$

in that order. With  $B = B_{ij}$ , since  $\text{OUT[ENTRY]} = 0$ ,  $iNpBi$ ' is the empty set, and  $\text{OUTfPi}$ ' is  $gen_{B_{ij}}$ . This value differs from the previous value  $\text{OUTpSi}$ '<sup>0</sup>, so

Block $B$	$OUT[B]^o$	$IN[B]^i$	$OUT[B]^i$	$W[B]^f$	$OVT[B]^f$
$B_1$	000 0000	000 0000	111 0000	000 0000	111 0000
$B_2$	000 0000	111 0000	001 1100	111 0111	001 1110
$B_3$	000 0000	001 1100	000 1110	001 1110	000 1110
$B_4$	000 0000	001 1110	001 0111	001 1110	001 0111
EXIT	000 0000	001 0111	001 0111	001 0111	001 0111

Figure 9.15: Computation of IN and OUT

we now know there is a change on the first round (and will proceed to a second round).

Then we consider  $B = B_2$  and compute

$$\begin{aligned}
 IN[B_2]^i &= OUT[B_2]^i \cup OUT[B_1]^o \\
 &= 111\ 0000 + 000\ 0000 = 111\ 0000 \\
 OUT[B_2]^f &= gen[B_2] \cup (IN[B_2]^i - kill[B_2]) \\
 &= 000\ 1100 + (111\ 0000 - 110\ 0001) = 001\ 1100
 \end{aligned}$$

This computation is summarized in Fig. 9.15. For instance, at the end of the first pass,  $OUT[B_2]^i = 001\ 1100$ , reflecting the fact that  $d_2$  and  $d_3$  are generated in  $B_2$ , while  $d_1$  reaches the beginning of  $B_2$  and is not killed in  $B_2$ .

Notice that after the second round,  $OUT[B_2]^f$  has changed to reflect the fact that  $d_4$  also reaches the beginning of  $B_2$  and is not killed by  $B_2$ . We did not learn that fact on the first pass, because the path from  $d_4$  to the end of  $B_2$ , which is  $B_2 \rightarrow B_3 \rightarrow B_4$ , is not traversed in that order by a single pass. That is, by the time we learn that  $d_4$  reaches the end of  $B_2$ , we have already computed  $IN[B_2]^i$  and  $OUT[B_2]^f$  on the first pass.

There are no changes in any of the OUT sets after the second pass. Thus, after a third pass, the algorithm terminates, with the IN's and OUT's as in the final two columns of Fig. 9.15. •

## 9.2.5 Live-Variable Analysis

Some code-improving transformations depend on information computed in the direction opposite to the flow of control in a program; we shall examine one such example now. In *live-variable analysis* we wish to know for variable  $x$  and point  $p$  whether the value of  $x$  at  $p$  could be used along some path in the flow graph starting at  $p$ . If so, we say  $x$  is *live* at  $p$ ; otherwise,  $x$  is *dead* at  $p$ .

An important use for live-variable information is register allocation for basic blocks. Aspects of this issue were introduced in Sections 8.6 and 8.8. After a value is computed in a register, and presumably used within a block, it is not

necessary to store that value if it is dead at the end of the block. Also, if all registers are full and we need another register, we should favor using a register with a dead value, since that value does not have to be stored.

Here, we define the data-flow equations directly in terms of  $\text{IN}[5]$  and  $\text{OUTpB}$ , which represent the set of variables live at the points immediately before and after block  $B$ , respectively. These equations can also be derived by first defining the transfer functions of individual statements and composing them to create the transfer function of a basic block. Define

1.  $\text{def}_B$  as the set of variables *defined* (i.e., definitely assigned values) in  $B$  prior to any use of that variable in  $B$ , and
2.  $\text{use}_B$  as the set of variables whose values may be used in  $B$  prior to any definition of the variable.

Example 9.13: For instance, block  $B_i$  in Fig. 9.13 definitely uses  $i$ . It also uses  $j$  before any redefinition of  $j$ , unless it is possible that  $i$  and  $j$  are aliases of one another. Assuming there are no aliases among the variables in Fig. 9.13, then  $\text{use}_{B_i} = \{i, j\}$ . Also,  $B_i$  clearly defines  $i$  and  $j$ . Assuming there are no aliases,  $\text{def}_{B_i} = \{i, j\}$  as well. •

As a consequence of the definitions, any variable in  $\text{use}_B$  must be considered live on entrance to block  $B$ , while definitions of variables in  $\text{def}_B$  definitely are dead at the beginning of  $B$ . In effect, membership in  $\text{def}_B$  "kills" any opportunity for a variable to be live because of paths that begin at  $B$ .

Thus, the equations relating  $\text{def}$  and  $\text{use}$  to the unknowns  $\text{IN}$  and  $\text{OUT}$  are defined as follows:

$$\text{IN}[\text{EXIT}] = \emptyset$$

and for all basic blocks  $B$  other than  $\text{EXIT}$

$$\begin{aligned} m[B] &= \text{use}_B \cup (\text{OUTpB} - \text{def}_B) \\ \text{OUT}[B] &= \bigcup_{S \text{ a successor of } B} \text{IN}[S] \end{aligned}$$

The first equation specifies the boundary condition, which is that no variables are live on exit from the program. The second equation says that a variable is live coming into a block if either it is used before redefinition in the block or it is live coming out of the block and is not redefined in the block. The third equation says that a variable is live coming out of a block if and only if it is live coming into one of its successors.

The relationship between the equations for liveness and the reaching-definitions equations should be noticed:



- Both sets of equations have union as the meet operator. The reason is that in each data-flow schema we propagate information along paths, and we care only about whether *any* path with desired properties exist, rather than whether something is true along *all* paths.
- However, information flow for liveness travels "backward," opposite to the direction of control flow, because in this problem we want to make sure that the use of a variable  $x$  at a point  $p$  is transmitted to all points prior to  $p$  in an execution path, so that we may know at the prior point that  $x$  will have its value used.

To solve a backward problem, instead of initializing `OUT[ENTRY]`, we initialize `IN[EXIT]`. Sets `IN` and `OUT` have their roles interchanged, and *use* and *def* substitute for *gen* and *kill*, respectively. As for reaching definitions, the solution to the liveness equations is not necessarily unique, and we want the solution with the smallest sets of live variables. The algorithm used is essentially a backwards version of Algorithm 9.11.

Algorithm 9.14: Live-variable analysis.

**INPUT:** A flow graph with *def* and *use* computed for each block.

**OUTPUT:**  $m[B]$  and `OUT[ $\epsilon$ ]`, the set of variables live on entry and exit of each block  $B$  of the flow graph.

**METHOD:** Execute the program in Fig. 9.16. •

```

IN[EXIT] = 0;
for (each basic block B other than EXIT) IN[B] = 0;
while (changes to any IN occur)
  for (each basic block B other than EXIT) {
    OUT[ $\epsilon$ ] =  $\bigcup$  U s a successor of B
    m[B] = useU (bUTpB) - defU;
  }

```

Figure 9.16: Iterative algorithm to compute live variables

## 9.2.6 Available Expressions

An expression  $x + y$  is *available* at a point  $p$  if every path from the entry node to  $p$  evaluates  $x + y$ , and after the last such evaluation prior to reaching  $p$ , there are no subsequent assignments to  $x$  or  $y$ .<sup>3</sup> For the available-expressions data-flow schema we say that a block *kills* expression  $x + y$  if it assigns (or may

<sup>3</sup>Note that, as usual in this chapter, we use the operator  $+$  as a generic operator, not necessarily standing for addition.

assign)  $x$  or  $y$  and does not subsequently recompute  $x + y$ . A block *generates* expression  $x + y$  if it definitely evaluates  $x + y$  and does not subsequently define  $x$  or  $y$ .

Note that the notion of "killing" or "generating" an available expression is not exactly the same as that for reaching definitions. Nevertheless, these notions of "kill" and "generate" behave essentially as they do for reaching definitions.

The primary use of available-expression information is for detecting global common subexpressions. For example, in Fig. 9.17(a), the expression  $4 * i$  in block  $B_2$  will be a common subexpression if  $4 * i$  is available at the entry point of block  $B_2$ . It will be available if  $i$  is not assigned a new value in block  $B_2$ , or if, as in Fig. 9.17(b),  $4 * i$  is recomputed after  $i$  is assigned in  $B_2$ .

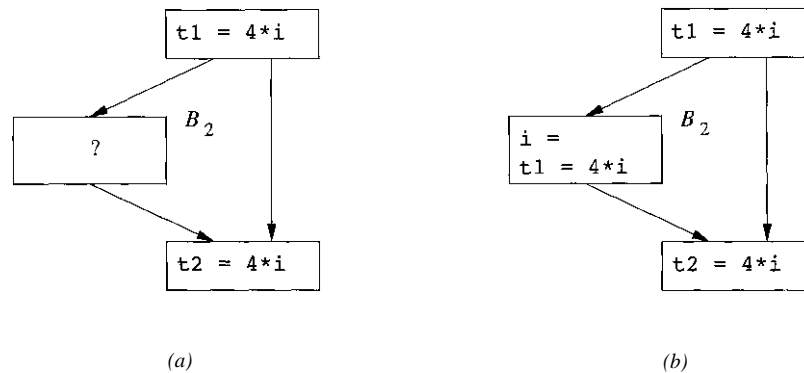

Figure 9.17: Potential common subexpressions across blocks

We can compute the set of generated expressions for each point in a block, working from beginning to end of the block. At the point prior to the block, no expressions are generated. If at point  $p$  set  $S$  of expressions is available, and  $q$  is the point after  $p$ , with statement  $x = y + z$  between them, then we form the set of expressions available at  $q$  by the following two steps.

1. Add to  $S$  the expression  $y + z$ .
2. Delete from  $S$  any expression involving variable  $x$ .

Note the steps must be done in the correct order, as  $x$  could be the same as  $y$  or  $z$ . After we reach the end of the block,  $S$  is the set of generated expressions for the block. The set of killed expressions is all expressions, say  $y + z$ , such that either  $y$  or  $z$  is defined in the block, and  $y + z$  is not generated by the block.

Example 9.15 : Consider the four statements of Fig. 9.18. After the first,  $b + c$  is available. After the second statement,  $a - d$  becomes available, but  $b + c$  is no longer available, because  $b$  has been redefined. The third statement does not make  $b + c$  available again, because the value of  $c$  is immediately changed.

After the last statement,  $a - d$  is no longer available, because  $d$  has changed. Thus no expressions are generated, and all expressions involving  $a$ ,  $b$ ,  $c$ , or  $d$  are killed. •

Statement	Available Expressions
	0
<b>a = b + c</b>	$\{b + c\}$
<b>b = a - d</b>	$\{a - d\}$
<b>c = b + c</b>	$\{a - d\}$
<b>d = a - d</b>	0

Figure 9.18: Computation of available expressions

We can find available expressions in a manner reminiscent of the way reaching definitions are computed. Suppose  $U$  is the "universal" set of all expressions appearing on the right of one or more statements of the program. For each block  $B$ , let  $\mathbf{IN}[B]$  be the set of expressions in  $U$  that are available at the point just before the beginning of  $B$ . Let  $\mathbf{OUT}[B]$  be the same for the point following the end of  $B$ . Define  $e\text{-gen}B$  to be the expressions generated by  $B$  and  $e\text{Kill}B$  to be the set of expressions in  $U$  killed in  $B$ . Note that  $\mathbf{IN}$ ,  $\mathbf{OUT}$ ,  $e\text{-gen}$ , and  $e\text{Kill}$  can all be represented by bit vectors. The following equations relate the unknowns  $\mathbf{IN}$  and  $\mathbf{OUT}$  to each other and the known quantities  $e\text{-gen}$  and  $e\text{Kill}$

$$\mathbf{OUT}[\mathbf{ENTRY}] = 0$$

and for all basic blocks  $B$  other than  $\mathbf{ENTRY}$ ,

$$\mathbf{OUT}[B] = e\text{-gen}B \cup (\mathbf{IN}[B] \cap e\text{Kill}B)$$

$$\mathbf{IN}[B] = \bigcap_{P \text{ a predecessor of } B} \mathbf{OUT}[P].$$

The above equations look almost identical to the equations for reaching definitions. Like reaching definitions, the boundary condition is  $\mathbf{OUT}[\mathbf{ENTRY}] = 0$ , because at the exit of the  $\mathbf{ENTRY}$  node, there are no available expressions. The most important difference is that the meet operator is intersection rather than union. This operator is the proper one because an expression is available at the beginning of a block only if it is available at the end of *all* its predecessors. In contrast, a definition reaches the beginning of a block whenever it reaches the end of any one or more of its predecessors.

The use of  $D$  rather than  $U$  makes the available-expression equations behave differently from those of reaching definitions. While neither set has a unique solution, for reaching definitions, it is the solution with the smallest sets that corresponds to the definition of "reaching," and we obtained that solution by starting with the assumption that nothing reached anywhere, and building up to the solution. In that way, we never assumed that a definition  $d$  could reach a point  $p$  unless an actual path propagating  $d$  to  $p$  could be found. In contrast, for available expression equations we want the solution with the largest sets of available expressions, so we start with an approximation that is too large and work down.

It may not be obvious that by starting with the assumption "everything (i.e., the set  $U$ ) is available everywhere except at the end of the entry block" and eliminating only those expressions for which we can discover a path along which it is not available, we do reach a set of truly available expressions. In the case of available expressions, it is conservative to produce a subset of the exact set of available expressions. The argument for subsets being conservative is that our intended use of the information is to replace the computation of an available expression by a previously computed value. Not knowing an expression is available only inhibits us from improving the code, while believing an expression is available when it is not could cause us to change what the program computes.

Figure 9.19: Initializing the **OUT** sets to 0 is too restrictive.

Example 9.16: We shall concentrate on a single block,  $B_j$  in Fig. 9.19, to illustrate the effect of the initial approximation of  $OUT[B_j]$  on  $IN$  [42]. Let  $G$  and  $K$  abbreviate  $e.genB_j$  and  $e.killB_j$ , respectively. The data-flow equations for block  $B_j$  are

$$in[B_j] = OUT[IN] \cup OUT[B_i]$$

$$OUT[B_j] = G \cup (in[B_j] - K)$$

These equations may be rewritten as recurrences, with  $P$  and  $O'$  being the  $j$ th

approximations of  $\text{IN}[S_i]$  and  $\text{OUT}[I_i]$ , respectively:

$$P^{i'} = \text{OUT}[S_i] \cap O^i$$

$$O^{i'} = GU (P^{i'} - K)$$

Starting with  $O^0 = 0$ , we get  $I^1 = \text{OUT}[S_1] \cap O^0 = 0$ . However, if we start with  $O^0 = U$ , then we get  $I^1 = \text{OUT}[S_1] \cap O^0 = \text{OUT}[S_1]$ , as we should. Intuitively, the solution obtained starting with  $O^0 = U$  is more desirable, because it correctly reflects the fact that expressions in  $\text{OUT}[J_i]$  that are not killed by  $P^{i'}$  are available at the end of  $J_i$ . •

Algorithm 9.17: Available expressions.

**INPUT:** A flow graph with *e-kills* and *e-gens* computed for each block *B*. The initial block is *B*.

**OUTPUT:**  $\text{IN}[B]$  and  $\text{OUT}[B]$ , the set of expressions available at the entry and exit of each block *B* of the flow graph.

**METHOD:** Execute the algorithm of Fig. 9.20. The explanation of the steps is similar to that for Fig. 9.14. •

```

OUT[ENTRY] = 0;
for (each basic block B other than ENTRY) OUT[P] = U;
while (changes to any OUT occur)
  for (each basic block B other than ENTRY) {
    m[B] = f, predecessor of B; OUT[P];
    OUT[P] = e-gens U (in[B] - e-killB);
  }

```

Figure 9.20: Iterative algorithm to compute available expressions

### 9.2.7 Summary

In this section, we have discussed three instances of data-flow problems: reaching definitions, live variables, and available expressions. As summarized in Fig. 9.21, the definition of each problem is given by the domain of the data-flow values, the direction of the data flow, the family of transfer functions, the boundary condition, and the meet operator. We denote the meet operator generically as *A*.

The last row shows the initial values used in the iterative algorithm. These values are chosen so that the iterative algorithm will find the most precise solution to the equations. This choice is not strictly a part of the definition of

the data-flow problem, since it is an artifact needed for the iterative algorithm. There are other ways of solving the problem. For example, we saw how the transfer function of a basic block can be derived by composing the transfer functions of the individual statements in the block; a similar compositional approach may be used to compute a transfer function for the entire procedure, or transfer functions from the entry of the procedure to any program point. We shall discuss such an approach in Section 9.7.

	Reaching Definitions	Live Variables	Available Expressions
Domain	Sets of definitions	Sets of variables	Sets of expressions
Direction	Forwards	Backwards	Forwards
Transfer function	$geriB \cup (x - kills)$	$useB \cup (x - def.)$	$e-geriB \cup (x - eJciZ/s)$
Boundary	$OUT[ENTRY] = 0$	$IN[EXIT] = 0$	$OUT[ENTRY] = 0$
Meet (A)	U	u	n
Equations	$OUT[B] = f_B(IN[B])$ $IN[J3] =$	$IN[B] = f_{..}(OUT[B])$ $OUT[JB] =$	$OUT[B1] = f_{..}(IN[B])$ $IN[\epsilon] =$ $A_{p, \dots, o, B} \quad OUT[P]$
Initialize	$OUT[\epsilon] = 0$	$IN[B] = 0$	$OUT[B] = U$

Figure 9.21: Summary of three data-flow problems

### 9.2.8 Exercises for Section 9.2

**Exercise 9.2.1:** For the flow graph of Fig. 9.10 (see the exercises for Section 9.1), compute

- The *gen* and *kill* sets for each block.
- The **IN** and **OUT** sets for each block.

**Exercise 9.2.2:** For the flow graph of Fig. 9.10, compute the  $e\_en$ ,  $eJkill$ , **IN**, and **OUT** sets for available expressions.

**Exercise 9.2.3:** For the flow graph of Fig. 9.10, compute the *def*, *use*, **INJ** and **OUT** sets for live variable analysis.

**! Exercise 9.2.4:** Suppose  $V$  is the set of complex numbers. Which of the following operations can serve as the meet operation for a semilattice on  $V$ ?

- Addition:  $(a + ib) \wedge (c + id) = (a + b) + i(c + d)$ .
- Multiplication:  $(a + ib) \wedge (c + id) = (ac - bd) + i(ad + bc)$ .

### Why the Available-Expressions Algorithm Works

We need to explain why starting all **OUT**'s except that for the entry block with  $U$ , the set of all expressions, leads to a conservative solution to the data-flow equations; that is, all expressions found to be available really *are* available. First, because intersection is the meet operation in this data-flow schema, any reason that an expression  $x + y$  is found not to be available at a point will propagate forward in the flow graph, along all possible paths, until  $x + y$  is recomputed and becomes available again. Second, there are only two reasons  $x + y$  could be unavailable:

1.  $x + y$  is killed in block  $B$  because  $x$  or  $y$  is defined without a subsequent computation of  $x + y$ . In this case, the first time we apply the transfer function  $f_B$ ,  $x + y$  will be removed from  $OVT[B]$ .
2.  $x + y$  is never computed along some path. Since  $x + y$  is never in  $OUT[ENTRY]$ , and it is never generated along the path in question, we can show by induction on the length of the path that  $x + y$  is eventually removed from **IN**'s and **OUT**'s along that path.

Thus, after changes subside, the solution provided by the iterative algorithm of Fig. 9.20 will include only truly available expressions.

c) Componentwise minimum:  $(a + ib) \wedge (c + id) = \min(\text{re}, c) + i \min(\text{im}, d)$ .

d) Componentwise maximum:  $(a + ib) \vee (c + id) = \max(\text{re}, c) + i \max(\text{im}, d)$ .

! Exercise 9.2.5: We claimed that if a block  $B$  consists of  $n$  statements, and the  $i$ th statement has gen and kill sets  $gen_i$  and  $kill_i$ , then the transfer function for block  $B$  has gen and kill sets  $gens$  and  $kills$  given by

$$kills = kill_1 \cup kill_2 \cup \dots \cup kill_n$$

$$gens = gen_n \cup (gen_{n-1} - kill_n) \cup (gen_{n-2} - kill_{n-1} - kill_n) \cup \dots \cup (gen_1 - kill_2 - \dots - kill_n).$$

Prove this claim by induction on  $n$ .

! Exercise 9.2.6: Prove by induction on the number of iterations of the for-loop of lines (4) through (6) of Algorithm 9.11 that none of the **IN**'s or **OUT**'s ever shrinks. That is, once a definition is placed in one of these sets on some round, it never disappears on a subsequent round.

! **Exercise 9.2.7:** Show the correctness of Algorithm 9.11. That is, show that

- a) If definition  $d$  is put in **IN** [ $B$ ] or **OUT**[ $2?$ ], then there is a path from  $d$  to the beginning or end of block  $B$ , respectively, along which the variable defined by  $d$  might not be redefined.
- b) If definition  $d$  is not put in  $w[B]$  or **OUT**[ $B$ ], then there is no path from  $d$  to the beginning or end of block  $B$ , respectively, along which the variable defined by  $d$  might not be redefined.

! **Exercise 9.2.8:** Prove the following about Algorithm 9.14:

- a) The **IN**'s and **OUT**'s never shrink.
- b) If variable  $x$  is put in  $m[B]$  or **OUTp9**], then there is a path from the beginning or end of block  $B$ , respectively, along which  $x$  might be used.
- c) If variable  $x$  is not put in **IN**[ $B$ ] or **OUTp9**], then there is no path from the beginning or end of block  $B$ , respectively, along which  $x$  might be used.

! **Exercise 9.2.9:** Prove the following about Algorithm 9.17:

- a) The **IN**'s and **OUT**'s never grow; that is, successive values of these sets are subsets (not necessarily proper) of their previous values.
- b) If expression  $e$  is removed from **IN**[ $B$ ] or **OUTpH**], then there is a path from the entry of the flow graph to the beginning or end of block  $B$ , respectively, along which  $e$  is either never computed, or after its last computation, one of its arguments might be redefined.
- c) If expression  $e$  remains in **IN**[ $B$ ] or **OUTpB**], then along every path from the entry of the flow graph to the beginning or end of block  $B$ , respectively,  $e$  is computed, and after the last computation, no argument of  $e$  could be redefined.

! **Exercise 9.2.10:** The astute reader will notice that in Algorithm 9.11 we could have saved some time by initializing **OUTpB**] to *gens* for all blocks  $B$ . Likewise, in Algorithm 9.14 we could have initialized  $m[B]$  to *gens*— We did not do so for uniformity in the treatment of the subject, as we shall see in Algorithm 9.25. However, is it possible to initialize **OUTpB**] to  $e^{\wedge}gens$  in Algorithm 9.17? Why or why not?

! **Exercise 9.2.11:** Our data-flow analyses so far do not take advantage of the semantics of conditionals. Suppose we find at the end of a basic block a test such as

```
if (x < 10) goto ...
```

How could we use our understanding of what the test  $x < 10$  means to improve our knowledge of reaching definitions? Remember, "improve" here means that we eliminate certain reaching definitions that really cannot ever reach a certain program point.



## 9.3 Foundations of Data-Flow Analysis

Having shown several useful examples of the data-flow abstraction, we now study the family of data-flow schemas as a whole, abstractly. We shall answer several basic questions about data-flow algorithms formally:

1. Under what circumstances is the iterative algorithm used in data-flow analysis correct?
2. How precise is the solution obtained by the iterative algorithm?
3. Will the iterative algorithm converge?
4. What is the meaning of the solution to the equations?

In Section 9.2, we addressed each of the questions above informally when describing the reaching-definitions problem. Instead of answering the same questions for each subsequent problem from scratch, we relied on analogies with the problems we had already discussed to explain the new problems. Here we present a general approach that answers all these questions, once and for all, rigorously, and for a large family of data-flow problems. We first identify the properties desired of data-flow schemas and prove the implications of these properties on the correctness, precision, and convergence of the data-flow algorithm, as well as the meaning of the solution. Thus, to understand old algorithms or formulate new ones, we simply show that the proposed data-flow problem definitions have certain properties, and the answers to all the above difficult questions are available immediately.

The concept of having a common theoretical framework for a class of schemas also has practical implications. The framework helps us identify the reusable components of the algorithm in our software design. Not only is coding effort reduced, but programming errors are reduced by not having to recode similar details several times.

A *data-flow analysis framework*  $(D,V,AF)$  consists of

1. A direction of the data flow  $D$ , which is either **FORWARDS** or **BACKWARDS**.
2. A semilattice (see Section 9.3.1 for the definition), which includes a *domain* of values  $V$  and a *meet operator*  $A$ .
3. A family  $F$  of transfer functions from  $V$  to  $V$ . This family must include functions suitable for the boundary conditions, which are constant transfer functions for the special nodes **ENTRY** and **EXIT** in any flow graph.

### 9.3.1 Semilattices

A *semilattice* is a set  $V$  and a binary meet operator  $A$  such that for all  $x$ ,  $y$ , and  $z$  in  $V$ :

1.  $x \wedge x = x$  (meet is *idempotent*).
2.  $x \wedge y = y \wedge x$  (meet is *commutative*).
3.  $x \wedge (y \wedge z) = (x \wedge y) \wedge z$  (meet is *associative*).

A semilattice has a *top* element, denoted  $\top$ , such that

$$\text{for all } x \text{ in } V, \top \wedge x = x.$$

Optionally, a semilattice may have a *bottom* element, denoted  $\perp$ , such that

$$\text{for all } x \text{ in } V, \perp \wedge x = \perp.$$

### Partial Orders

As we shall see, the meet operator of a semilattice defines a partial order on the values of the domain. A relation  $<$  is a *partial order* on a set  $V$  if for all  $x$ ,  $y$ , and  $z$  in  $V$ :

1.  $x < x$  (the partial order is *reflexive*).
2. If  $x < y$  and  $y < x$ , then  $x = y$  (the partial order is *antisymmetric*).
3. If  $x < y$  and  $y < z$ , then  $x < z$  (the partial order is *transitive*).

The pair  $(V, <)$  is called a *poset*, or *partially ordered set*. It is also convenient to have a  $<$  relation for a poset, defined as

$$x < y \text{ if and only if } (x \wedge y) \wedge x = x \text{ and } (x \wedge y) \wedge y = y.$$

### The Partial Order for a Semilattice

It is useful to define a partial order  $<$  for a semilattice  $(V, \wedge)$ . For all  $x$  and  $y$  in  $V$ , we define

$$x < y \text{ if and only if } x \wedge y = x.$$

Because the meet operator  $\wedge$  is idempotent, commutative, and associative, the  $<$  order as defined is reflexive, antisymmetric, and transitive. To see why, observe that:

- **Reflexivity:** for all  $x$ ,  $x < x$ . The proof is that  $x \wedge x = x$  since meet is idempotent.
- **Antisymmetry:** if  $x < y$  and  $y < x$ , then  $x = y$ . In proof,  $x < y$  means  $x \wedge y = x$  and  $y < x$  means  $y \wedge x = y$ . By commutativity of  $\wedge$ ,  $x = (x \wedge y) = (y \wedge x) = y$ .

- **Transitivity:** if  $x < y$  and  $y < z$ , then  $x < z$ . In proof,  $x < y$  and  $y < z$  means that  $x \sqcap y = x$  and  $y \sqcap z = y$ . Then  $(x \sqcap z) = ((x \sqcap y) \sqcap z) = (x \sqcap (y \sqcap z)) = (x \sqcap y) = x$ , using associativity of meet. Since  $x \sqcap z = x$  has been shown, we have  $x < z$ , proving transitivity.

**Example 9.18:** The meet operators used in the examples in Section 9.2 are set union and set intersection. They are both idempotent, commutative, and associative. For set union, the top element is 0 and the bottom element is  $U$ , the universal set, since for any subset  $x \in U$ ,  $x \cup x = x$  and  $U \cup x = U$ . For set intersection,  $\mathbf{T}$  is  $U$  and  $\perp$  is 0.  $V$ , the domain of values of the semilattice, is the set of all subsets of  $U$ , which is sometimes called the *power set* of  $U$  and denoted  $2^U$ .

For all  $x$  and  $y \in V$ ,  $x \cup y = x$  implies  $x \sqsubseteq y$ ; therefore, the partial order imposed by set union is  $D$ , set inclusion. Correspondingly, the partial order imposed by set intersection is  $C$ , set containment. That is, for set intersection, sets with fewer elements are considered to be smaller in the partial order. However, for set union, sets with *more* elements are considered to be smaller in the partial order. To say that sets larger in size are smaller in the partial order is counterintuitive; however, this situation is an unavoidable consequence of the definitions.<sup>6</sup>

As discussed in Section 9.2, there are usually many solutions to a set of data-flow equations, with the greatest solution (in the sense of the partial order  $<$ ) being the most precise. For example, in reaching definitions, the most precise among all the solutions to the data-flow equations is the one with the smallest number of definitions, which corresponds to the greatest element in the partial order defined by the meet operation, union. In available expressions, the most precise solution is the one with the largest number of expressions. Again, it is the greatest solution in the partial order defined by intersection as the meet operation. •

### Greatest Lower Bounds

There is another useful relationship between the meet operation and the partial ordering it imposes. Suppose  $(V, \sqcap)$  is a semilattice. A *greatest lower bound* (or *gib*) of domain elements  $x$  and  $y$  is an element  $g$  such that

1.  $g \sqsubseteq x$ ,
2.  $g \sqsubseteq y$ , and
3. If  $z$  is any element such that  $z \sqsubseteq x$  and  $z \sqsubseteq y$ , then  $z \sqsubseteq g$ .

It turns out that the meet of  $x$  and  $y$  is their only greatest lower bound. To see why, let  $g = x \sqcap y$ . Observe that:

<sup>6</sup> And if we defined the partial order to be  $>$  instead of  $<$ , then the problem would surface when the meet was intersection, although not for union.

### Joins, Lub's, and Lattices

In symmetry to the *gib* operation on elements of a poset, we may define the *least upper bound* (or *lub*) of elements  $x$  and  $y$  to be that element  $b$  such that  $x < b$ ,  $y < b$ , and if  $z$  is any element such that  $x < z$  and  $y < z$ , then  $b < z$ . One can show that there is at most one such element  $b$  if it exists.

In a true *lattice*, there are two operations on domain elements, the meet  $\wedge$ , which we have seen, and the operator *join*, denoted  $\vee$ , which gives the lub of two elements (which therefore must always exist in the lattice). We have been discussing only "semi" lattices, where only one of the meet and join operators exist. That is, our semilattices are *meet semilattices*. One could also speak of *join semilattices*, where only the join operator exists, and in fact some literature on program analysis does use the notation of join semilattices. Since the traditional data-flow literature speaks of meet semilattices, we shall also do so in this book.

- $g < x$  because  $(x \vee y) \wedge x = x \wedge y$ . The proof involves simple uses of associativity, commutativity, and idempotence. That is,

$$\begin{aligned} g \wedge x &= ((x \vee y) \wedge x) = (x \wedge (y \vee x)) = \\ &= (x \wedge (x \vee y)) = ((x \wedge x) \vee y) = \\ &= (x \vee y) = g \end{aligned}$$

- $g < y$  by a similar argument.
- Suppose  $z$  is any element such that  $z < x$  and  $z < y$ . We claim  $z < g$ , and therefore,  $z$  cannot be a *gib* of  $x$  and  $y$  unless it is also  $g$ . In proof:  $(z \vee g) \wedge x = (z \vee (x \vee y)) \wedge x = ((z \vee x) \vee y) \wedge x$ . Since  $z < x$ , we know  $(z \vee x) = x$ , so  $(z \vee g) \wedge x = (x \vee y) \wedge x = z \wedge x = z$ . Since  $z < y$ , we know  $z \vee y = y$ , and therefore  $z \vee g = y$ . We have proven  $z < g$  and conclude  $g = x \vee y$  is the only *gib* of  $x$  and  $y$ .

### Lattice Diagrams

It often helps to draw the domain  $V$  as a lattice diagram, which is a graph whose nodes are the elements of  $V$ , and whose edges are directed downward, from  $x$  to  $y$  if  $y < x$ . For example, Fig. 9.22 shows the set  $V$  for a reaching-definitions data-flow schema where there are three definitions:  $d_1$ ,  $d_2$ , and  $d_3$ . Since  $<$  is an edge is directed downward from any subset of these three definitions to each of its supersets. Since  $<$  is transitive, we conventionally omit the edge from  $x$

to  $y$  as long as there is another path from  $x$  to  $y$  left in the diagram. Thus, although  $\{d_1, d_2, d_3\} < \{d_1\}$ , we do not draw this edge since it is represented by the path through  $\{d_1, d_2\}$ , for example.

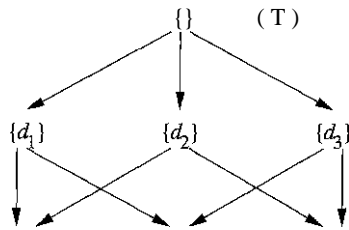

Figure 9.22: Lattice of subsets of definitions

It is also useful to note that we can read the meet off such diagrams. Since  $x \mathbf{A} y$  is the gib, it is always the highest  $z$  for which there are paths downward to  $z$  from both  $x$  and  $y$ . For example, if  $x$  is  $\{d_1\}$  and  $y$  is  $\{d_2\}$ , then  $z$  in Fig. 9.22 is  $\{d_1, d_2\}$ , which makes sense, because the meet operator is union. The top element will appear at the top of the lattice diagram; that is, there is a path downward from  $T$  to each element. Likewise, the bottom element will appear at the bottom, with a path downward from every element to  $\_L$ .

### Product Lattices

While Fig. 9.22 involves only three definitions, the lattice diagram of a typical program can be quite large. The set of data-flow values is the power set of the definitions, which therefore contains  $2^n$  elements if there are  $n$  definitions in the program. However, whether a definition reaches a program is independent of the reachability of the other definitions. We may thus express the lattice of definitions in terms of a "product lattice," built from one simple lattice for each definition. That is, if there were only one definition  $d$  in the program, then the lattice would have two elements:  $\{\}$ , the empty set, which is the top element, and  $\{d\}$ , which is the bottom element.

Formally, we may build product lattices as follows. Suppose  $(A, \mathbf{A} \mathbf{A})$  and  $(B, \mathbf{A} \mathbf{B})$  are (semi)lattices. The *product lattice* for these two lattices is defined as follows:

1. The domain of the product lattice is  $A \times B$ .

In this discussion and subsequently, we shall often drop the "semi," since lattices like the one under discussion do have a join or lub operator, even if we do not make use of it.

2. The meet  $\wedge$  for the product lattice is defined as follows. If  $(a, b)$  and  $(a', b')$  are domain elements of the product lattice, then

$$(a, b) \wedge (a', b') = (a \wedge a', b \wedge b'). \quad (9.19)$$

It is simple to express the  $<$  partial order for the product lattice in terms of the partial orders  $<_A$  and  $<_B$  for  $A$  and  $B$

$$(a, b) < (a', b') \text{ if and only if } a <_A a' \text{ and } b <_B b'. \quad (9.20)$$

To see why (9.20) follows from (9.19), observe that

$$(a, b) \wedge (a', b') = (a \wedge a', b \wedge b').$$

So we might ask under what circumstances does  $(a \wedge a', b \wedge b') = (a, b)$ ? That happens exactly when  $a \wedge a' = a$  and  $b \wedge b' = b$ . But these two conditions are the same as  $a <_A a'$  and  $b <_B b'$ .

The product of lattices is an associative operation, so one can show that the rules (9.19) and (9.20) extend to any number of lattices. That is, if we are given lattices  $(A_i, \wedge_i)$  for  $i = 1, 2, \dots, k$ , then the product of all  $k$  lattices, in this order, has domain  $A_1 \times A_2 \times \dots \times A_k$ , a meet operator defined by

$$((a_1, a_2, \dots, a_k) \wedge (b_1, b_2, \dots, b_k)) = (a_1 \wedge b_1, a_2 \wedge b_2, \dots, a_k \wedge b_k)$$

and a partial order defined by

$$((a_1, a_2, \dots, a_k) < (b_1, b_2, \dots, b_k)) \text{ if and only if } a_i < b_i \text{ for all } i.$$

### Height of a Semilattice

We may learn something about the rate of convergence of a data-flow analysis algorithm by studying the "height" of the associated semilattice. An *ascending chain* in a poset  $(V, <)$  is a sequence where  $x_1 < x_2 < \dots < x_n$ . The *height* of a semilattice is the largest number of  $<$  relations in any ascending chain; that is, the height is one less than the number of elements in the chain. For example, the height of the reaching definitions semilattice for a program with  $n$  definitions is  $n$ .

Showing convergence of an iterative data-flow algorithm is much easier if the semilattice has finite height. Clearly, a lattice consisting of a finite set of values will have a finite height; it is also possible for a lattice with an infinite number of values to have a finite height. The lattice used in the constant propagation algorithm is one such example that we shall examine closely in Section 9.4.

### 9.3.2 Transfer Functions

The family of transfer functions  $F : V \rightarrow V$  in a data-flow framework has the following properties:

1.  $F$  has an identity function  $i$ , such that  $I(x) = x$  for all  $x$  in  $V$ .
2.  $F$  is closed under composition; that is, for any two functions  $f$  and  $g$  in  $F$ , the function  $h$  defined by  $h(x) = g(f(x))$  is in  $F$ .

Example 9.21: In reaching definitions,  $F$  has the identity, the function where  $gen$  and  $kill$  are both the empty set. Closure under composition was actually shown in Section 9.2.4; we repeat the argument succinctly here. Suppose we have two functions

$$f_1(x) = G_1 \cup U(x - K_1) \quad \text{and} \quad f_2(x) = G_2 \cup U(x - K_2).$$

Then

$$h(f_1 f_2)(x) = G_2 \cup ((G_1 \cup U(x - K_1)) - K_2).$$

The right side of the above is algebraically equivalent to

$$(G_2 \cup (G_1 - K_2)) \cup U(x - (K_1 \cup K_2)).$$

If we let  $K = K_1 \cup K_2$  and  $G = G_2 \cup (G_1 - K_2)$  then we have shown that the composition of  $f_1$  and  $f_2$ , which is  $f(x) = G \cup U(x - K)$ , is of the form that makes it a member of  $F$ . If we consider available expressions, the same arguments used for reaching definitions also show that  $F$  has an identity and is closed under composition. •

### Monotone Frameworks

To make an iterative algorithm for data-flow analysis work, we need for the data-flow framework to satisfy one more condition. We say that a framework is *monotone* if when we apply any transfer function  $f$  in  $F$  to two members of  $V$ , the first being no greater than the second, then the first result is no greater than the second result.

Formally, a data-flow framework  $(D, F, V, \mathbf{A})$  is *monotone* if

$$\text{For all } x \text{ and } y \text{ in } V \text{ and } f \text{ in } F, x < y \text{ implies } f(x) < f(y). \quad (9.22)$$

Equivalently, monotonicity can be defined as

$$\text{For all } x \text{ and } y \text{ in } V \text{ and } f \text{ in } F, f(x \sqcap y) < f(x) \sqcap f(y). \quad (9.23)$$

Equation (9.23) says that if we take the meet of two values and then apply  $f$ , the result is never greater than what is obtained by applying  $f$  to the values individually first and then "meeting" the results. Because the two definitions of monotonicity seem so different, they are both useful. We shall find one or the other more useful under different circumstances. Later, we sketch a proof to show that they are indeed equivalent.

We shall first assume (9.22) and show that (9.23) holds. Since  $x \wedge y$  is the greatest lower bound of  $x$  and  $y$ , we know that

$$x \wedge y < x \text{ and } x \wedge y < y.$$

Thus, by (9.22),

$$f(x \wedge y) < f(x) \text{ and } f(x \wedge y) < f(y).$$

Since  $f(x) \wedge f(y)$  is the greatest lower bound of  $f(x)$  and  $f(y)$ , we have (9.23).

Conversely, let us assume (9.23) and prove (9.22). We suppose  $x < y$  and use (9.23) to conclude  $f(x) < f(y)$ , thus proving (9.22). Equation (9.23) tells us

$$f(x \wedge y) < f(x) \wedge f(y).$$

But since  $x < y$  is assumed,  $x \wedge y = x$ , by definition. Thus (9.23) says

$$f(x) < f(x) \wedge f(y).$$

Since  $f(x) \wedge f(y)$  is the gib of  $f(x)$  and  $f(y)$ , we know  $f(x) \wedge f(y) < f(y)$ . Thus

$$f(x) < f(x) \wedge f(y) < f(y)$$

and (9.23) implies (9.22).

#### Distributive Frameworks

Often, a framework obeys a condition stronger than (9.23), which we call the *distributivity condition*,

$$f(x \wedge y) = f(x) \wedge f(y)$$

for all  $x$  and  $y$  in  $V$  and  $f$  in  $F$ . Certainly, if  $a = b$ , then  $a \wedge b = a$  by idempotence, so  $a < b$ . Thus, distributivity implies monotonicity, although the converse is not true.

Example 9.24: Let  $y$  and  $z$  be sets of definitions in the reaching-definitions framework. Let  $f$  be a function defined by  $f(x) = G \cup (x - K)$  for some sets of definitions  $G$  and  $K$ . We can verify that the reaching-definitions framework satisfies the distributivity condition, by checking that

$$G \cup ((y \cup z) - K) = (G \cup (y - K)) \cup (G \cup (z - K)).$$

While the equation above may appear formidable, consider first those definitions in  $G$ . These definitions are surely in the sets defined by both the left and right sides. Thus, we have only to consider definitions that are not in  $G$ . In that case, we can eliminate  $G$  everywhere, and verify the equality

$$(y \cup z) - K = (y - K) \cup (z - K).$$

The latter equality is easily checked using a Venn diagram. •



### 9.3.3 The Iterative Algorithm for General Frameworks

We can generalize Algorithm 9.11 to make it work for a large variety of data-flow problems.

Algorithm 9.25: Iterative solution to general data-flow frameworks.

**INPUT:** A data-flow framework with the following components:

1. A data-flow graph, with specially labeled **ENTRY** and **EXIT** nodes,
2. A direction of the data-flow  $D$ ,
3. A set of values  $V$ ,
4. A meet operator  $A$ ,
5. A set of functions  $F$ , where  $f_s$  in  $F$  is the transfer function for block  $B$ , and
6. A constant value **GENTRY** or **f EXIT** in  $V$ , representing the boundary condition for forward and backward frameworks, respectively.

**OUTPUT:** Values in  $V$  for **IN**[ $B$ ] and **OUT**[ $B$ ] for each block  $B$  in the data-flow graph.

**METHOD:** The algorithms for solving forward and backward data-flow problems are shown in Fig. 9.23(a) and 9.23(b), respectively. As with the familiar iterative data-flow algorithms from Section 9.2, we compute **IN** and **OUT** for each block by successive approximation. •

It is possible to write the forward and backward versions of Algorithm 9.25 so that a function implementing the meet operation is a parameter, as is a function that implements the transfer function for each block. The flow graph itself and the boundary value are also parameters. In this way, the compiler implementor can avoid recoding the basic iterative algorithm for each data-flow framework used by the optimization phase of the compiler.

We can use the abstract framework discussed so far to prove a number of useful properties of the iterative algorithm:

1. If Algorithm 9.25 converges, the result is a solution to the data-flow equations.
2. If the framework is monotone, then the solution found is the maximum fixedpoint (MFP) of the data-flow equations. A *maximum fixedpoint* is a solution with the property that in any other solution, the values of **IN**[ $B$ ] and **OUT** [ $B$ ] are  $<$  the corresponding values of the MFP.
3. If the semilattice of the framework is monotone and of finite height, then the algorithm is guaranteed to converge.

```

1)  OUT[ENTRY] = GENIN,
2)  for (each basic block B other than ENTRY) OUT[B] = T;
3)  while (changes to any OUT occur)
4)      for (each basic block B other than ENTRY) {
5)          IN[B] = AP a predecessor of B
6)          OUT[B] = /*(IN[B]);
      }

```

(a) Iterative algorithm for a forward data-flow problem.

```

1)  IN[EXIT] = VEXIT
2)  for (each basic block B other than EXIT) IN[B] = T;
3)  while (changes to any IN occur)
4)      for (each basic block B other than EXIT) {
5)          OUT[B] = As a successor of B
6)          IN[B] = /*(OUT[B]);
      }

```

(b) Iterative algorithm for a backward data-flow problem.

Figure 9.23: Forward and backward versions of the iterative algorithm

We shall argue these points assuming that the framework is forward. The case of backwards frameworks is essentially the same. The first property is easy to show. If the equations are not satisfied by the time the while-loop ends, then there will be at least one change to an OUT (in the forward case) or IN (in the backward case), and we must go around the loop again.

To prove the second property, we first show that the values taken on by IN[B] and OUT[B] for any B can only decrease (in the sense of the < relationship for lattices) as the algorithm iterates. This claim can be proven by induction.

**BASIS:** The base case is to show that the value of IN[B] and OUT[B] after the first iteration is not greater than the initialized value. This statement is trivial because IN[B] and OUT[B] for all blocks B ≠ ENTRY are initialized with T.

**INDUCTION:** Assume that after the kth iteration, the values are all no greater than those after the (k - 1)st iteration, and show the same for iteration k + 1 compared with iteration k. Line (5) of Fig. 9.23(a) has

$$\text{IN}[B] = \bigwedge_{P \text{ a predecessor of } B} \text{OUT}[P].$$

Let us use the notation IN[B]<sup>i</sup> and OUT[B]<sup>i</sup> to denote the values of IN[B] and OUT[B] after iteration i. Assuming OUT[P]<sup>i</sup> < OUT[P]<sup>i-1</sup>, we know that IN[B]<sup>i+1</sup> < IN[B]<sup>i</sup> because of the properties of the meet operator. Next, line (6)

says

$$\text{OUT}[\mathcal{E}] = \bigwedge_n (\text{IN}[\mathcal{E}]).$$

Since  $m[B]^{k+1} < m[B]^k$ , we have  $\text{OUT}[B]^{k+1} < \text{OVT}[B]^k$  by monotonicity.

Note that every change observed for values of  $\text{IN}[J3]$  and  $\text{OUTpS}$  is necessary to satisfy the equation. The meet operators return the greatest lower bound of their inputs, and the transfer functions return the only solution that is consistent with the block itself and its given input. Thus, if the iterative algorithm terminates, the result must have values that are at least as great as the corresponding values in any other solution; that is, the result of Algorithm 9.25 is the MFP of the equations.

Finally, consider the third point, where the data-flow framework has finite height. Since the values of every  $\text{IN}[B]$  and  $\text{OUT}[\mathcal{E}]$  decrease with each change, and the algorithm stops if at some round nothing changes, the algorithm is guaranteed to converge after a number of rounds no greater than the product of the height of the framework and the number of nodes of the flow graph.

### 9.3.4 Meaning of a Data-Flow Solution

We now know that the solution found using the iterative algorithm is the maximum fixedpoint, but what does the result represent from a program-semantics point of view? To understand the solution of a data-flow framework  $(D, F, V, A)$ , let us first describe what an ideal solution to the framework would be. We show that the ideal cannot be obtained in general, but that Algorithm 9.25 approximates the ideal conservatively.

#### The Ideal Solution

Without loss of generality, we shall assume for now that the data-flow framework of interest is a forward-flowing problem. Consider the entry point of a basic block  $B$ . The ideal solution begins by finding all the *possible* execution paths leading from the program entry to the beginning of  $B$ . A path is "possible" only if there is some computation of the program that follows exactly that path. The ideal solution would then compute the data-flow value at the end of each possible path and apply the meet operator to these values to find their greatest lower bound. Then no execution of the program can produce a smaller value for that program point. In addition, the bound is tight; there is no greater data-flow value that is a gib for the value computed along every possible path to  $B$  in the flow graph.

We now try to define the ideal solution more formally. For each block  $B$  in a flow graph, let  $f_B$  be the transfer function for  $B$ . Consider any path

$$P = \text{ENTRY} \rightarrow B_1 \rightarrow \dots \rightarrow B_{i-1} \rightarrow B_i$$

from the initial node  $\text{ENTRY}$  to some block  $B_i$ . The program path may have cycles, so one basic block may appear several times on the path  $P$ . Define the

transfer function for  $P$ ,  $f_P$ , to be the composition of  $f_{B_i} \circ \dots \circ f_{B_1}$ . Note that  $f_{B_n}$  is not part of the composition, reflecting the fact that this path is taken to reach the beginning of block  $B_n$ , not its end. The data-flow value created by executing this path is thus  $f_P(v_{\text{ENTRY}})$ , where  $v_{\text{ENTRY}}$  is the result of the constant transfer function representing the initial node ENTRY. The ideal result for block  $B$  is thus

$$\text{IDEAL}[B] = \bigwedge_{P, \text{ a possible path from ENTRY to } B} f_P(v_{\text{ENTRY}}).$$

We claim that, in terms of the lattice-theoretic partial order  $<$  for the framework in question,

- Any answer that is greater than IDEAL is incorrect.
- Any value smaller than or equal to the ideal is conservative, i.e., safe.

Intuitively, the closer the value to the ideal the more precise it is.<sup>8</sup> To see why solutions must be  $<$  the ideal solution, note that any solution greater than IDEAL for any block could be obtained by ignoring some execution path that the program could take, and we cannot be sure that there is not some effect along that path to invalidate any program improvement we might make based on the greater solution. Conversely, any solution less than IDEAL can be viewed as including certain paths that either do not exist in the flow graph, or that exist but that the program can never follow. This lesser solution will allow only transformations that are correct for all possible executions of the program, but may forbid some transformations that IDEAL would permit.

### The Meet-Over-Paths Solution

However, as discussed in Section 9.1, finding all possible execution paths is undecidable. We must therefore approximate. In the data-flow abstraction, we assume that every path in the flow graph can be taken. Thus, we can define the meet-over-paths solution for  $B$  to be

$$\text{MOP}[B] = \bigwedge_{P, \text{ a path from ENTRY to } B} f_P(v_{\text{ENTRY}}).$$

Note that, as for IDEAL, the solution MOP[B] gives values for IN[B] in forward-flow frameworks. If we were to consider backward-flow frameworks, then we would think of MOP[B] as a value for OUT[B].

The paths considered in the MOP solution are a superset of all the paths that are possibly executed. Thus, the MOP solution meets together not only the data-flow values of all the executable paths, but also additional values associated

<sup>8</sup>Note that in forward problems, the value IDEAL[B] is what we would like  $m[B]$  to be. In backward problems, which we do not discuss here, we would define IDEAL[B] to be the ideal value of OUT[B].

with the paths that cannot possibly be executed. Taking the meet of the ideal solution plus additional terms cannot create a solution larger than the ideal. Thus, for all  $B$  we have  $\mathbf{MOP}[B] < \mathbf{IDEAL}[B]$ , and we will simply say that  $\mathbf{MOP} < \mathbf{IDEAL}$ .

### The Maximum Fixedpoint Versus the MOP Solution

Notice that in the  $\mathbf{MOP}$  solution, the number of paths considered is still unbounded if the flow graph contains cycles. Thus, the  $\mathbf{MOP}$  definition does not lend itself to a direct algorithm. The iterative algorithm certainly does not first find all the paths leading to a basic block before applying the meet operator. Rather,

1. The iterative algorithm visits basic blocks, not necessarily in the order of execution.
2. At each confluence point, the algorithm applies the meet operator to the data-flow values obtained so far. Some of these values used were introduced artificially in the initialization process, not representing the result of any execution from the beginning of the program.

So what is the relationship between the  $\mathbf{MOP}$  solution and the solution  $\mathbf{MFP}$  produced by Algorithm 9.25?

We first discuss the order in which the nodes are visited. In an iteration, we may visit a basic block before having visited its predecessors. If the predecessor is the  $\mathbf{ENTRY}$  node,  $\mathbf{OUT}[\mathbf{ENTRY}]$  would have already been initialized with the proper, constant value. Otherwise, it has been initialized to  $\mathbf{T}$ , a value no smaller than the final answer. By monotonicity, the result obtained by using  $\mathbf{T}$  as input is no smaller than the desired solution. In a sense, we can think of  $\mathbf{T}$  as representing no information.

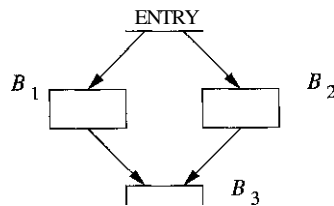

Figure 9.24: Flow graph illustrating the effect of early meet over paths

What is the effect of applying the meet operator early? Consider the simple example of Fig. 9.24, and suppose we are interested in the value of  $\mathbf{INp9}_i$ . By

the definition of **MOP**

$$\mathbf{MOP}[E_i] = (UB, \cdot / \mathbf{BJ} \wedge UB, \circ / \mathbf{B}_i)(\mathbf{VENTRY})$$

In the iterative algorithm, if we visit the nodes in the order  $B_1, B_2, B_3, B_4$ , then

$$\mathbf{IN}[B_4] = f_{B_3} \left( (f_{B_1}(v_{\mathbf{ENTRY}}) \wedge f_{B_2}(v_{\mathbf{ENTRY}})) \right)$$

While the meet operator is applied at the end in the definition of **MOP**, the iterative algorithm applies it early. The answer is the same only if the data-flow framework is distributive. If the data-flow framework is monotone but not distributive, we still have  $\mathbf{IN}[E_i] < \mathbf{MOP}[E_i]$ . Recall that in general a solution  $\mathbf{IN}[B]$  is safe (conservative) if  $\mathbf{IN}[B] < \mathbf{IDEAL}[B]$  for all blocks  $B$ . Surely,  $\mathbf{MOP}[E_i] < \mathbf{IDEAL}[E_i]$ .

We now provide a quick sketch of why in general the **MFP** solution provided by the iterative algorithm is always safe. An easy induction on  $i$  shows that the values obtained after  $i$  iterations are smaller than or equal to the meet over all paths of length  $i$  or less. But the iterative algorithm terminates only if it arrives at the same answer as would be obtained by iterating an unbounded number of times. Thus, the result is no greater than the **MOP** solution. Since  $\mathbf{MOP} < \mathbf{IDEAL}$  and  $\mathbf{MFP} < \mathbf{MOP}$ , we know that  $\mathbf{MFP} < \mathbf{IDEAL}$ , and therefore the solution **MFP** provided by the iterative algorithm is safe.

### 9.3.5 Exercises for Section 9.3

Exercise 9.3.1: Construct a lattice diagram for the product of three lattices, each based on a single definition  $d_i$ , for  $i = 1, 2, 3$ . How is your lattice diagram related to that in Fig. 9.22?

Exercise 9.3.2: In Section 9.3.3 we argued that if the framework has finite height, then the iterative algorithm converges. Here is an example where the framework does not have finite height, and the iterative algorithm does not converge. Let the set of values  $V$  be the nonnegative real numbers, and let the meet operator be the minimum. There are three transfer functions:

- i. The identity,  $f_i(x) = x$ .
- ii. "half," that is, the function  $f_{ii}(x) = x/2$ .
- Hi. "one," that is, the function  $f_{Hi}(x) = 1$ .

The set of transfer functions  $F$  is these three plus the functions formed by composing them in all possible ways.

- a) Describe the set  $F$ .
- b) What is the  $<$  relationship for this framework?

- c) Give an example of a flow graph with assigned transfer functions, such that Algorithm 9.25 does not converge.
- d) Is this framework monotone? Is it distributive?

**! Exercise 9.3.3:** We argued that Algorithm 9.25 converges if the framework is monotone and of finite height. Here is an example of a framework that shows monotonicity is essential; finite height is not enough. The domain  $V$  is  $\{1,2\}$ , the meet operator is  $\min$ , and the set of functions  $F$  is only the identity ( $/j$ ) and the "switch" function ( $fs(x) = 3 - x$ ) that swaps 1 and 2.

- a) Show that this framework is of finite height but not monotone.
- b) Give an example of a flow graph and assignment of transfer functions so that Algorithm 9.25 does not converge.

**! Exercise 9.3.4:** Let  $MOPi[B]$  be the meet over all paths of length  $i$  or less from the entry to block  $B$ . Prove that after  $i$  iterations of Algorithm 9.25,  $IN[B] < MOPi[B]$ . Also, show that as a consequence, if Algorithm 9.25 converges, then it converges to something that is  $<$  the MOP solution.

**! Exercise 9.3.5:** Suppose the set  $F$  of functions for a framework are all of gen-kill form. That is, the domain  $V$  is the power set of some set, and  $f(x) = G \cup (x - K)$  for some sets  $G$  and  $K$ . Prove that if the meet operator is either (a) union or (b) intersection, then the framework is distributive.

## 9.4 Constant Propagation

All the data-flow schemas discussed in Section 9.2 are actually simple examples of distributive frameworks with finite height. Thus, the iterative Algorithm 9.25 applies to them in either its forward or backward version and produces the MOP solution in each case. In this section, we shall examine in detail a useful data-flow framework with more interesting properties.

Recall that constant propagation, or "constant folding," replaces expressions that evaluate to the same constant every time they are executed, by that constant. The constant-propagation framework described below is different from all the data-flow problems discussed so far, in that

- a) it has an unbounded set of possible data-flow values, even for a fixed flow graph, and
- b) it is not distributive.

Constant propagation is a forward data-flow problem. The semilattice representing the data-flow values and the family of transfer functions are presented next.

### 9.4.1 Data-Flow Values for the Constant-Propagation Framework

The set of data-flow values is a product lattice, with one component for each variable in a program. The lattice for a single variable consists of the following:

1. All constants appropriate for the type of the variable.
2. The value **NAC**, which stands for not-a-constant. A variable is mapped to this value if it is determined not to have a constant value. The variable may have been assigned an input value, or derived from a variable that is not a constant, or assigned different constants along different paths that lead to the same program point.
3. The value **UNDEF**, which stands for undefined. A variable is assigned this value if nothing may yet be asserted; presumably, no definition of the variable has been discovered to reach the point in question.

Note that **NAC** and **UNDEF** are not the same; they are essentially opposites. **NAC** says we have seen so many ways a variable could be defined that we know it is not constant; **UNDEF** says we have seen so little about the variable that we cannot say anything at all.

The semilattice for a typical integer-valued variable is shown in Fig. 9.25. Here the top element is **UNDEF**, and the bottom element is **NAC**. That is, the greatest value in the partial order is **UNDEF** and the least is **NAC**. The constant values are unordered, but they are all less than **UNDEF** and greater than **NAC**. As discussed in Section 9.3.1, the meet of two values is their greatest lower bound. Thus, for all values  $v$ ,

$$\mathbf{UNDEF} \wedge v = v \text{ and } \mathbf{NAC} \wedge v = \mathbf{NAC}.$$

For any constant  $c$ ,

$$c \wedge c = c$$

and given two distinct constants  $c_1$  and  $c_2$ ,

$$c_1 \wedge c_2 = \mathbf{NAC}.$$

A data-flow value for this framework is a map from each variable in the program to one of the values in the constant semilattice. The value of a variable  $v$  in a map  $m$  is denoted by  $m(v)$ .

### 9.4.2 The Meet for the Constant-Propagation Framework

The semilattice of data-flow values is simply the product of the semilattices like Fig. 9.25, one for each variable. Thus,  $m < m'$  if and only if for all variables  $v$  we have  $m(v) < m'(v)$ . Put another way,  $m \wedge m' = m''$  if  $m''(v) = m(v) \wedge m'(v)$  for all variables  $v$ .



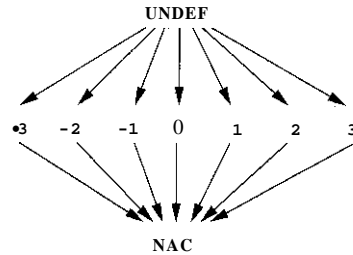

Figure 9.25: Semilattice representing the possible "values" of a single integer variable

### 9.4.3 Transfer Functions for the Constant-Propagation Framework

We assume in the following that a basic block contains only one statement. Transfer functions for basic blocks containing several statements can be constructed by composing the functions corresponding to individual statements. The set  $F$  consists of certain transfer functions that accept a map of variables to values in the constant lattice and return another such map.

$F$  contains the identity function, which takes a map as input and returns the same map as output.  $F$  also contains the constant transfer function for the **ENTRY** node. This transfer function, given any input map, returns a map  $mo$ , where  $mo(v) = \text{UNDEF}$ , for all variables  $v$ . This boundary condition makes sense, because before executing any program statements there are no definitions for any variables.

In general, let  $f_s$  be the transfer function of statement  $s$ , and let  $m$  and  $m'$  represent data-flow values such that  $m' = f_s(m)$ . We shall describe  $f_s$  in terms of the relationship between  $m$  and  $m'$ .

1. If  $s$  is not an assignment statement, then  $f_s$  is simply the identity function.
2. If  $s$  is an assignment to variable  $x$ , then  $m'(v) = m(v)$ , for all variables  $v \neq x$ , provided one of the following conditions holds:

- (a) If the right-hand-side (RHS) of the statement  $s$  is a constant  $c$ , then  $m'(x) = c$ .
- (b) If the RHS is of the form  $y + z$ , then\*

$$m'(x) = \begin{cases} m(y) + m(z) & \text{if } m(y) \text{ and } m(z) \text{ are constant values} \\ \mathbf{NAC} & \text{if either } m(y) \text{ or } m(z) \text{ is } \mathbf{NAC} \\ \mathbf{UNDEF} & \text{otherwise} \end{cases}$$

- (c) If the RHS is any other expression (e.g. a function call or assignment through a pointer), then  $m'(x) = \mathbf{NAC}$ .

\*As usual,  $+$  represents a generic operator, not necessarily addition.

### 9.4.4 Monotonicity of the Constant-Propagation Framework

Let us show that the constant propagation framework is monotone. First, we can consider the effect of a function  $f_i$  on a single variable. In all but case 2(b),  $f_i$  either does not change the value of  $m(x)$ , or it changes the map to return a constant or **NAC**. In these cases,  $f_i$  must surely be monotone.

For case 2(b), the effect of  $f_i$  is tabulated in Fig 9.26. The first and second columns represent the possible input values of  $y$  and  $z$  the last represents the output value of  $x$ . The values are ordered from the greatest to the smallest in each column or sub column. To show that the function is monotone, we check that for each possible input value of  $y$ , the value of  $x$  does not get bigger as the value of  $z$  gets smaller. For example, in the case where  $y$  has a constant value  $c_1$ , as the value of  $z$  varies from **UNDEF** to  $c_2$  to **NAC**, the value of  $x$  varies from **UNDEF**, to  $c_1 + c_2$ , and then to **NAC**, respectively. We can repeat this procedure for all the possible values of  $y$ . Because of symmetry, we do not even need to repeat the procedure for the second operand before we conclude that the output value cannot get larger as the input gets smaller.

$m(y)$	$m(z)$	$m'(x)$
<b>UNDEF</b>	<b>UNDEF</b>	<b>UNDEF</b>
	$c_2$	<b>UNDEF</b>
	<b>NAC</b>	<b>NAC</b>
<b>C1</b>	<b>UNDEF</b>	<b>UNDEF</b>
	$c_2$	$C1 + c_2$
	<b>NAC</b>	<b>NAC</b>
<b>NAC</b>	<b>UNDEF</b>	<b>NAC</b>
	$c_2$	<b>NAC</b>
	<b>NAC</b>	<b>NAC</b>

Figure 9.26: The constant-propagation transfer function for  $x = y+z$

### 9.4.5 Nondistributivity of the Constant-Propagation Framework

The constant-propagation framework as defined is monotone but not distributive. That is, the iterative solution MFP is safe but may be smaller than the MOP solution. An example will prove that the framework is not distributive.

Example 9.26: In the program in Fig. 9.27,  $x$  and  $y$  are set to 2 and 3 in block  $B_1$ , and to 3 and 2, respectively, in block  $B_2$ . We know that regardless of which path is taken, the value of  $z$  at the end of block  $B_3$  is 5. The iterative algorithm does not discover this fact, however. Rather, it applies the meet operator at the entry of  $B_3$ , getting **NAC**'S as the values of  $x$  and  $y$ . Since adding two **NAC**'s

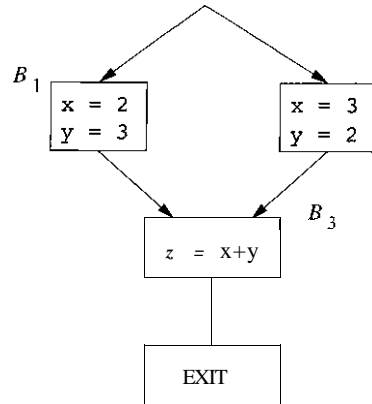

Figure 9.27: An example demonstrating that the constant propagation framework is not distributive

yields a NAC, the output produced by Algorithm 9.25 is that  $z$  — NAC at the exit of the program. This result is safe, but imprecise. Algorithm 9.25 is imprecise because it does not keep track of the correlation that whenever  $x$  is 2,  $y$  is 3, and vice versa. It is possible, but significantly more expensive, to use a more complex framework that tracks all the possible equalities that hold among pairs of expressions involving the variables in the program; this approach is discussed in Exercise 9.4.2.

Theoretically, we can attribute this loss of precision to the nondistributivity of the constant propagation framework. Let  $/i$ ,  $f_s$ , and  $fa$  be the transfer functions representing blocks  $B_1$ ,  $B_2$ , and  $B_3$ , respectively. As shown in Fig 9.28,

$$h\{f_i(m_0) \wedge /200\} < h\{h\{m_0\} \wedge /_s(/2(m_0))\}$$

rendering the framework nondistributive. •

$m$	$m(x)$	$m(y)$	$m(z)$
$m_0$	UNDEF	UNDEF	UNDEF
$h(m_0)$	2	3	UNDEF
<b>/200</b>	3	2	UNDEF
$/i(m_0) \wedge A/_2(m_0)$	NAC	NAC	UNDEF
$hU_i\{m_0\} \wedge A/_2(m_0)$	NAC	NAC	NAC
$h\{h\bar{i}o\}$	2	3	5
$/s(/2(m_0))$	3	2	5
$/s(/iN) \wedge /3(/2(m_0))$	NAC	NAC	5

Figure 9.28: Example of nondistributive transfer functions

### 9.4.6 Interpretation of the Results

The value `UNDEF` is used in the iterative algorithm for two purposes: to initialize the `ENTRY` node and to initialize the interior points of the program before the iterations. The meaning is slightly different in the two cases. The first says that variables are undefined at the beginning of the program execution; the second says that for lack of information at the beginning of the iterative process, we approximate the solution with the top element `UNDEF`. At the end of the iterative process, the variables at the exit of the `ENTRY` node will still hold the `UNDEF` value, since `OUT[ENTRY]` never changes.

It is possible that `UNDEF`'s may show up at some other program points. When they do, it means that no definitions have been observed for that variable along any of the paths leading up to that program point. Notice that with the way we define the meet operator, as long as there exists a path that defines a variable reaching a program point, the variable will not have an `UNDEF` value. If all the definitions reaching a program point have the same constant value, the variable is considered a constant even though it may not be defined along some program path.

By assuming that the program is correct, the algorithm can find more constants than it otherwise would. That is, the algorithm conveniently chooses some values for those possibly undefined variables in order to make the program more efficient. This change is legal in most programming languages, since undefined variables are allowed to take on any value. If the language semantics requires that all undefined variables be given some specific value, then we must change our problem formulation accordingly. And if instead we are interested in finding possibly undefined variables in a program, we can formulate a different data-flow analysis to provide that result (see Exercise 9.4.1).

**Example 9.27:** In Fig. 9.29, the values of  $x$  are 10 and `UNDEF` at the exit of basic blocks  $B_1$  and  $B_2$ , respectively. Since `UNDEF`  $\wedge$  10 = 10, the value of  $x$  is 10 on entry to block  $B_4$ . Thus, block  $B_3$ , where  $x$  is used, can be optimized by replacing  $x$  by 10. Had the path executed been  $B_1 \rightarrow B_2 \rightarrow B_3$ , the value of  $x$  reaching basic block  $B_5$  would have been undefined. So, it appears incorrect to replace the use of  $x$  by 10.

However, if it is impossible for predicate  $Q$  to be false while  $Q'$  is true, then this execution path never occurs. While the programmer may be aware of that fact, it may well be beyond the capability of any data-flow analysis to determine. Thus, if we assume that the program is correct and that all the variables are defined before they are used, it is indeed correct that the value of  $x$  at the beginning of basic block  $B_3$  can only be 10. And if the program is incorrect to begin with, then choosing 10 as the value of  $x$  cannot be worse than allowing  $x$  to assume some random value. •

### 9.4.7 Exercises for Section 9.4

! Exercise 9.4.1: Suppose we wish to detect all possibility of a variable being

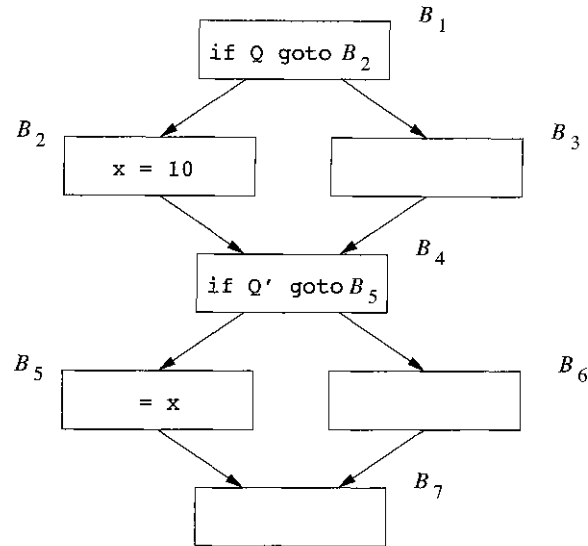

Figure 9.29: Meet of UNDEF and a constant

uninitialized along any path to a point where it is used. How would you modify the framework of this section to detect such situations?

!! Exercise 9.4.2: An interesting and powerful data-flow-analysis framework is obtained by imagining the domain  $V$  to be all possible partitions of expressions, so that two expressions are in the same class if and only if they are certain to have the same value along any path to the point in question. To avoid having to list an infinity of expressions, we can represent  $V$  by listing only the minimal pairs of equivalent expressions. For example, if we execute the statements

```

a = b
c = a + d

```

then the minimal set of equivalences is  $\{a = b, c = a + d\}$ . From these follow other equivalences, such as  $c = b + d$  and  $a + e = b + e$ , but there is no need to list these explicitly.

- What is the appropriate meet operator for this framework?
- Give a data structure to represent domain values and an algorithm to implement the meet operator.
- What are the appropriate functions to associate with statements? Explain the effect that a statement such as  $a = b + c$  should have on a partition of expressions (i.e., on a value in  $V$ ).
- Is this framework monotone? Distributive?

## 9.5 Partial-Redundancy Elimination

In this section, we consider in detail how to minimize the number of expression evaluations. That is, we want to consider all possible execution sequences in a flow graph, and look at the number of times an expression such as  $x + y$  is evaluated. By moving around the places where  $x + y$  is evaluated and keeping the result in a temporary variable when necessary, we often can reduce the number of evaluations of this expression along many of the execution paths, while not increasing that number along any path. Note that the number of different places in the flow graph where  $x + y$  is evaluated may increase, but that is relatively unimportant, as long as the number of *evaluations* of the expression  $x + y$  is reduced.

Applying the code transformation developed here improves the performance of the resulting code, since, as we shall see, an operation is never applied unless it absolutely has to be. Every optimizing compiler implements something like the transformation described here, even if it uses a less "aggressive" algorithm than the one of this section. However, there is another motivation for discussing the problem. Finding the right place or places in the flow graph at which to evaluate each expression requires four different kinds of data-flow analyses. Thus, the study of "partial-redundancy elimination," as minimizing the number of expression evaluations is called, will enhance our understanding of the role data-flow analysis plays in a compiler.

Redundancy in programs exists in several forms. As discussed in Section 9.1.4, it may exist in the form of common subexpressions, where several evaluations of the expression produce the same value. It may also exist in the form of a loop-invariant expression that evaluates to the same value in every iteration of the loop. Redundancy may also be partial, if it is found along some of the paths, but not necessarily along *all* paths. Common subexpressions and loop-invariant expressions can be viewed as special cases of partial redundancy; thus a single partial-redundancy-elimination algorithm can be devised to eliminate all the various forms of redundancy.

In the following, we first discuss the different forms of redundancy, in order to build up our intuition about the problem. We then describe the generalized redundancy-elimination problem, and finally we present the algorithm. This algorithm is particularly interesting, because it involves solving multiple data-flow problems, in both the forward and backward directions.

### 9.5.1 The Sources of Redundancy

Figure 9.30 illustrates the three forms of redundancy: common subexpressions, loop-invariant expressions, and partially redundant expressions. The figure shows the code both before and after each optimization.

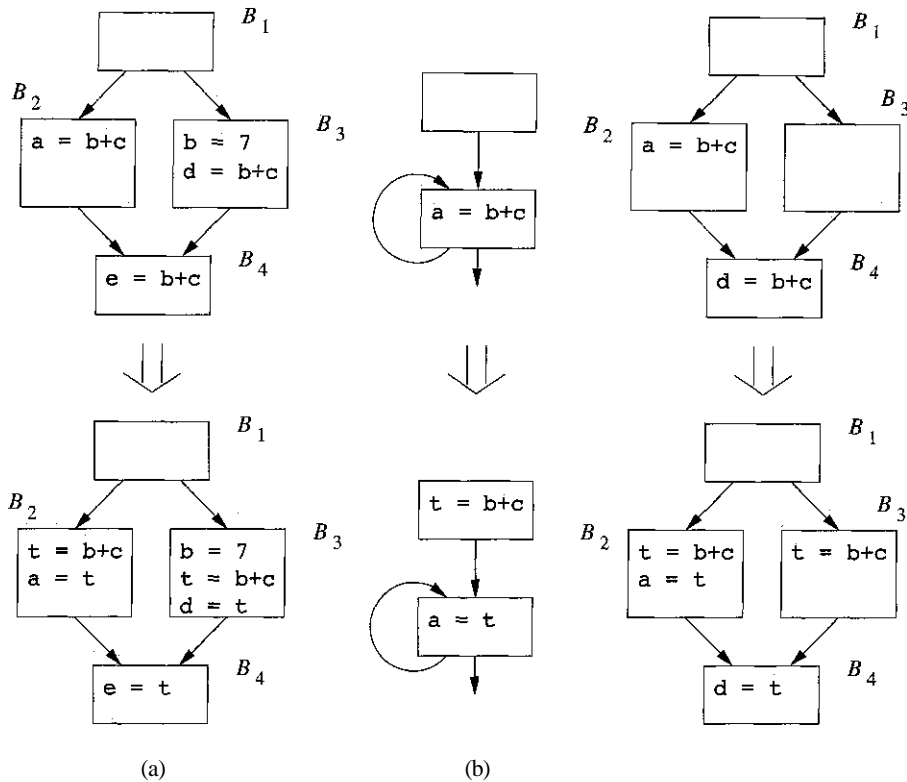

Figure 9.30: Examples of (a) global common subexpression, (b) loop-invariant code motion, (c) partial-redundancy elimination.

### Global Common Subexpressions

In Fig. 9.30(a), the expression  $b + c$  computed in block  $B_4$  is redundant; it has already been evaluated by the time the flow of control reaches  $B_4$ , regardless of the path taken to get there. As we observe in this example, the value of the expression may be different on different paths. We can optimize the code by storing the result of the computations of  $b + c$  in blocks  $B_2$  and  $B_3$  in the same temporary variable, say  $t$ , and then assigning the value of  $t$  to the variable  $e$  in block  $B_4$ , instead of reevaluating the expression. Had there been an assignment to either  $b$  or  $c$  after the last computation of  $b + c$  but before block  $B_4$ , the expression in block  $B_4$  would not be redundant.

Formally, we say that an expression  $b + c$  is (fully) *redundant* at point  $p$ , if it is an available expression, in the sense of Section 9.2.6, at that point. That is, the expression  $b + c$  has been computed along all paths reaching  $p$ , and the variables  $b$  and  $c$  were not redefined after the last expression was evaluated. The latter condition is necessary, because even though the expression  $b + c$  is textually executed before reaching the point  $p$ , the value of  $b + c$  computed at

### Finding "Deep" Common Subexpressions

Using available-expressions analysis to identify redundant expressions only works for expressions that are textually identical. For example, an application of common-subexpression elimination will recognize that  $t1$  in the code fragment

$$t1 = b + c; a = t1 + d;$$

has the same value as does  $t2$  in

$$t2 = b + c; e = t2 + d;$$

as long as the variables  $b$  and  $c$  have not been redefined in between. It does not, however, recognize that  $a$  and  $e$  are also the same. It is possible to find such "deep" common subexpressions by re-applying common subexpression elimination until no new common subexpressions are found on one round. It is also possible to use the framework of Exercise 9.4.2 to catch deep common subexpressions.

point  $p$  would have been different, because the operands might have changed.

#### Loop-Invariant Expressions

Fig. 9.30(b) shows an example of a loop-invariant expression. The expression  $b + c$  is loop invariant assuming neither the variable  $b$  nor  $c$  is redefined within the loop. We can optimize the program by replacing all the re-executions in a loop by a single calculation outside the loop. We assign the computation to a temporary variable, say  $t$ , and then replace the expression in the loop by  $t$ . There is one more point we need to consider when performing "code motion" optimizations such as this. We should not execute any instruction that would not have executed without the optimization. For example, if it is possible to exit the loop without executing the loop-invariant instruction at all, then we should not move the instruction out of the loop. There are two reasons.

1. If the instruction raises an exception, then executing it may throw an exception that would not have happened in the original program.
2. When the loop exits early, the "optimized" program takes more time than the original program.

To ensure that loop-invariant expressions in while-loops can be optimized, compilers typically represent the statement



```

while c {
    s;
}

```

in the same way as the statement

```

if c {
    repeat
        s;
    until not c;
}

```

In this way, loop-invariant expressions can be placed just prior to the repeat-until construct.

Unlike common-subexpression elimination, where a redundant expression computation is simply dropped, loop-invariant-expression elimination requires an expression from inside the loop to move outside the loop. Thus, this optimization is generally known as "loop-invariant code motion." Loop-invariant code motion may need to be repeated, because once a variable is determined to have a loop-invariant value, expressions using that variable may also become loop-invariant.

#### Partially Redundant Expressions

An example of a partially redundant expression is shown in Fig. 9.30(c). The expression  $b + c$  in block  $B4$  is redundant on the path  $B1 \rightarrow B2 \rightarrow B4$ , but not on the path  $B1 \rightarrow B3 \rightarrow B4$ . We can eliminate the redundancy on the former path by placing a computation of  $b + c$  in block  $B2$ . All the results of  $b + c$  are written into a temporary variable  $t$ , and the calculation in block  $B4$  is replaced with  $t$ . Thus, like loop-invariant code motion, partial-redundancy elimination requires the placement of new expression computations.

### 9.5.2 Can All Redundancy Be Eliminated?

Is it possible to eliminate all redundant computations along every path? The answer is "no," unless we are allowed to change the flow graph by creating new blocks.

Example 9.28: In the example shown in Fig. 9.31(a), the expression of  $b + c$  is computed redundantly in block  $B4$  if the program follows the execution path  $B1 \rightarrow B2 \rightarrow B4$ . However, we cannot simply move the computation of  $b + c$  to block  $B2$ , because doing so would create an extra computation of  $b + c$  when the path  $B1 \rightarrow B3 \rightarrow B4$  is taken.

What we would like to do is to insert the computation of  $b + c$  only along the edge from block  $B2$  to block  $B4$ . We can do so by placing the instruction in a new block, say,  $B_0$  and making the flow of control from  $B2$  go through  $B_0$  before it reaches  $B4$ . The transformation is shown in Fig. 9.31(b). •

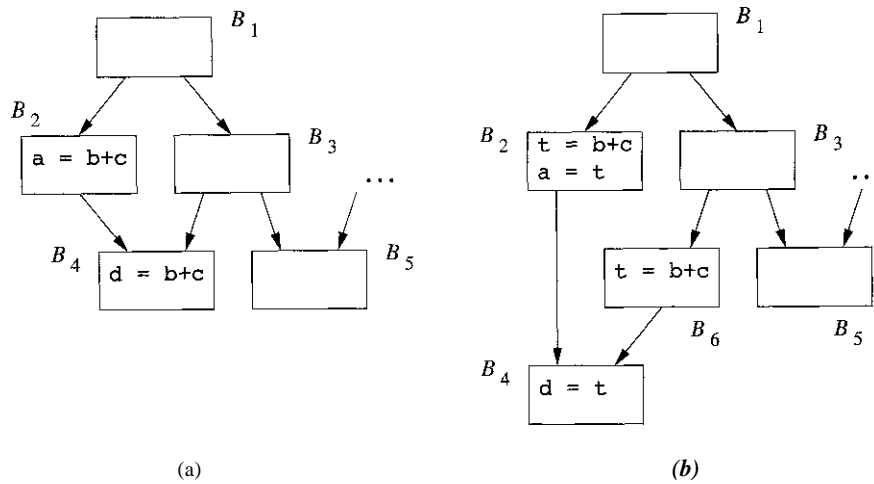

Figure 9.31:  $B_3 \rightarrow B_4$  is a critical edge

We define a *critical edge* of a flow graph to be any edge leading from a node with more than one successor to a node with more than one predecessor. By introducing new blocks along critical edges, we can always find a block to accommodate the desired expression placement. For instance, the edge from  $B_3$  to  $B_4$  in Fig. 9.31(a) is critical, because  $B_3$  has two successors, and  $B_4$  has two predecessors.

Adding blocks may not be sufficient to allow the elimination of all redundant computations. As shown in Example 9.29, we may need to duplicate code so as to isolate the path where redundancy is found.

Example 9.29: In the example shown in Figure 9.32(a), the expression of  $b+c$  is computed redundantly along the path  $B_1 \rightarrow B_2 \rightarrow B_4 \rightarrow BQ$ . We would like to remove the redundant computation of  $b+c$  from block  $BQ$  in this path and compute the expression only along the path  $B_1 \rightarrow B_2 \rightarrow B_3 \rightarrow BQ$ . However, there is no single program point or edge in the source program that corresponds uniquely to the latter path. To create such a program point, we can duplicate the pair of blocks  $B_4$  and  $BQ$ , with one pair reached through  $B_2$  and the other reached through  $B_3$  as shown in Figure 9.32(b). The result of  $b+c$  is saved in variable  $t$  in block  $B_3$ , and moved to variable  $d$  in  $B'Q$ , the copy of  $BQ$  reached from  $B_2$ .

Since the number of paths is exponential in the number of conditional branches in the program, eliminating all redundant expressions can greatly increase the size of the optimized code. We therefore restrict our discussion of redundancy-elimination techniques to those that may introduce additional blocks but that do not duplicate portions of the control flow graph.

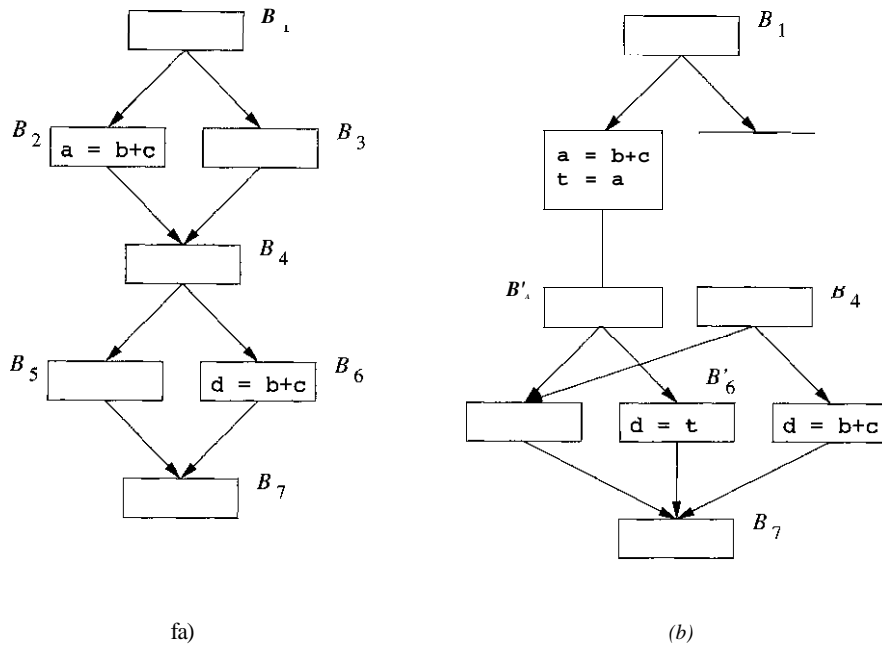

Figure 9.32: Code duplication to eliminate redundancies

### 9.5.3 The Lazy-Code-Motion Problem

It is desirable for programs optimized with a partial-redundancy-elimination algorithm to have the following properties:

1. All redundant computations of expressions that can be eliminated without code duplication are eliminated.
2. The optimized program does not perform any computation that is not in the original program execution.
3. Expressions are computed at the latest possible time.

The last property is important because the values of expressions found to be redundant are usually held in registers until they are used. Computing a value as late as possible minimizes its lifetime — the duration between the time the value is defined and the time it is last used, which in turn minimizes its usage of a register. We refer to the optimization of eliminating partial redundancy with the goal of delaying the computations as much as possible as *lazy code motion*.

To build up our intuition of the problem, we first discuss how to reason about partial redundancy of a single expression along a single path. For convenience, we assume for the rest of the discussion that every statement is a basic block of its own.

**Full Redundancy**

An expression  $e$  in block  $B$  is redundant if along all paths reaching  $B$ ,  $e$  has been evaluated and the operands of  $e$  have not been redefined subsequently. Let  $S$  be the set of blocks, each containing expression  $e$ , that renders  $e$  in  $B$  redundant. The set of edges leaving the blocks in  $S$  must necessarily form a *cutset*, which if removed, disconnects block  $B$  from the entry of the program. Moreover, no operands of  $e$  are redefined along the paths that lead from the blocks in  $S$  to  $B$ .

**Partial Redundancy**

If an expression  $e$  in block  $B$  is only partially redundant, the lazy-code-motion algorithm attempts to render  $e$  fully redundant in  $B$  by placing additional copies of the expressions in the flow graph. If the attempt is successful, the optimized flow graph will also have a set of basic blocks  $S$ , each containing expression  $e$ , and whose outgoing edges are a cutset between the entry and  $B$ . Like the fully redundant case, no operands of  $e$  are redefined along the paths that lead from the blocks in  $S$  to  $B$ .

**9.5.4 Anticipation of Expressions**

There is an additional constraint imposed on inserted expressions to ensure that no extra operations are executed. Copies of an expression must be placed only at program points where the expression is *anticipated*. We say that an expression  $b + c$  is *anticipated* at point  $p$  if all paths leading from the point  $p$  eventually compute the value of the expression  $b + c$  from the values of  $b$  and  $c$  that are available at that point.

Let us now examine what it takes to eliminate partial redundancy along an acyclic path  $B_1 \rightarrow B_2 \rightarrow \dots \rightarrow B_n$ . Suppose expression  $e$  is evaluated only in blocks  $B_1$  and  $B_n$ , and that the operands of  $e$  are not redefined in blocks along the path. There are incoming edges that join the path and there are outgoing edges that exit the path. We see that  $e$  is *not* anticipated at the entry of block  $B_i$  if and only if there exists an outgoing edge leaving block  $B_j$ ,  $i < j < n$ , that leads to an execution path that does not use the value of  $e$ . Thus, anticipation limits how early an expression can be inserted.

We can create a cutset that includes the edge  $B_{i-1} \rightarrow B_i$  and that renders  $e$  redundant in  $B_i$  if  $e$  is either available or anticipated at the entry of  $B_i$ . If  $e$  is anticipated but not available at the entry of  $B_i$ , we must place a copy of the expression  $e$  along the incoming edge.

We have a choice of where to place the copies of the expression, since there are usually several cutsets in the flow graph that satisfy all the requirements. In the above, computation is introduced along the incoming edges to the path of interest and so the expression is computed as close to the use as possible, without introducing redundancy. Note that these introduced operations may themselves be partially redundant with other instances of the same expression

in the program. Such partial redundancy may be eliminated by moving these computations further up.

In summary, anticipation of expressions limits how early an expression can be placed; you cannot place an expression so early that it is not anticipated where you place it. The earlier an expression is placed, the more redundancy can be removed, and among all solutions that eliminate the same redundancies, the one that computes the expressions the latest minimizes the lifetimes of the registers holding the values of the expressions involved.

### 9.5.5 The Lazy-Code-Motion Algorithm

This discussion thus motivates a four-step algorithm. The first step uses anticipation to determine where expressions can be placed; the second step finds the *earliest* cutset, among those that eliminate as many redundant operations as possible without duplicating code and without introducing any unwanted computations. This step places the computations at program points where the values of their results are first anticipated. The third step then pushes the cutset down to the point where any further delay would alter the semantics of the program or introduce redundancy. The fourth and final step is a simple pass to clean up the code by removing assignments to temporary variables that are used only once. Each step is accomplished with a data-flow pass: the first and fourth are backward-flow problems, the second and third are forward-flow problems.

#### Algorithm Overview

1. Find all the expressions anticipated at each program point using a backward data-flow pass.
2. The second step places the computation where the values of the expressions are first anticipated along some path. After we have placed copies of an expression where the expression is first anticipated, the expression would be *available* at program point  $p$  if it has been anticipated along all paths reaching  $p$ . Availability can be solved using a forward data-flow pass. If we wish to place the expressions at the earliest possible positions, we can simply find those program points where the expressions are anticipated but are not available.
3. Executing an expression as soon as it is anticipated may produce a value long before it is used. An expression is *postponable* at a program point if the expression has been anticipated and has yet to be used along any path reaching the program point. Postponable expressions are found using a forward data-flow pass. We place expressions at those program points where they can no longer be postponed.
4. A simple, final backward data-flow pass is used to eliminate assignments to temporary variables that are used only once in the program.

### Preprocessing Steps

We now present the full lazy-code-motion algorithm. To keep the algorithm simple, we assume that initially every statement is in a basic block of its own, and we only introduce new computations of expressions at the beginnings of blocks. To ensure that this simplification does not reduce the effectiveness of the technique, we insert a new block between the source and the destination of an edge if the destination has more than one predecessor. Doing so obviously also takes care of all critical edges in the program.

We abstract the semantics of each block  $B$  with two sets:  $e\text{-uses}$  is the set of expressions computed in  $B$  and  $e\text{-kills}$  is the set of expressions killed, that is, the set of expressions any of whose operands are defined in  $B$ . Example 9.30 will be used throughout the discussion of the four data-flow analyses whose definitions are summarized in Fig. 9.34.

**Example 9.30:** In the flow graph in Fig. 9.33(a), the expression  $b + c$  appears three times. Because the block  $B_5$  is part of a loop, the expression may be computed many times. The computation in block  $BQ$  is not only loop invariant; it is also a redundant expression, since its value already has been used in block  $Bj$ . For this example, we need to compute  $b+c$  only twice, once in block  $B_5$  and once along the path after  $B_5$  and before  $B_7$ . The lazy code motion algorithm will place the expression computations at the beginning of blocks  $B4$  and  $B5$ .

•

### Anticipated Expressions

Recall that an expression  $b + c$  is anticipated at a program point  $p$  if all paths leading from point  $p$  eventually compute the value of the expression  $b + c$  from the values of  $b$  and  $c$  that are available at that point.

In Fig. 9.33(a), all the blocks anticipating  $b + c$  on entry are shown as lightly shaded boxes. The expression  $b + c$  is anticipated in blocks  $B3$ ,  $B4$ ,  $B5$ ,  $B6$ ,  $Bj$ , and  $BQ$ . It is not anticipated on entry to block  $B_5$ , because the value of  $c$  is recomputed within the block, and therefore the value of  $b + c$  that would be computed at the beginning of  $B_5$  is not used along any path. The expression  $b+c$  is not anticipated on entry to  $B_5$ , because it is unnecessary along the branch from  $B_5$  to  $B_5$  (although it would be used along the path  $B_5 \rightarrow B_5 \rightarrow BQ$ ). Similarly, the expression is not anticipated at the beginning of  $B_5$ , because of the branch from  $B_5$  to  $Bn$ . The anticipation of an expression may oscillate along a path, as illustrated by  $B7 \rightarrow Bg \rightarrow BQ$ .

The data-flow equations for the anticipated-expressions problem are shown in Fig 9.34(a). The analysis is a backward pass. An anticipated expression at the exit of a block  $B$  is an anticipated expression on entry only if it is not in the  $e\text{-kills}$  set. Also a block  $B$  generates as new uses the set of  $e\text{juses}$  expressions. At the exit of the program, none of the expressions are anticipated. Since we are interested in finding expressions that are anticipated along every subsequent

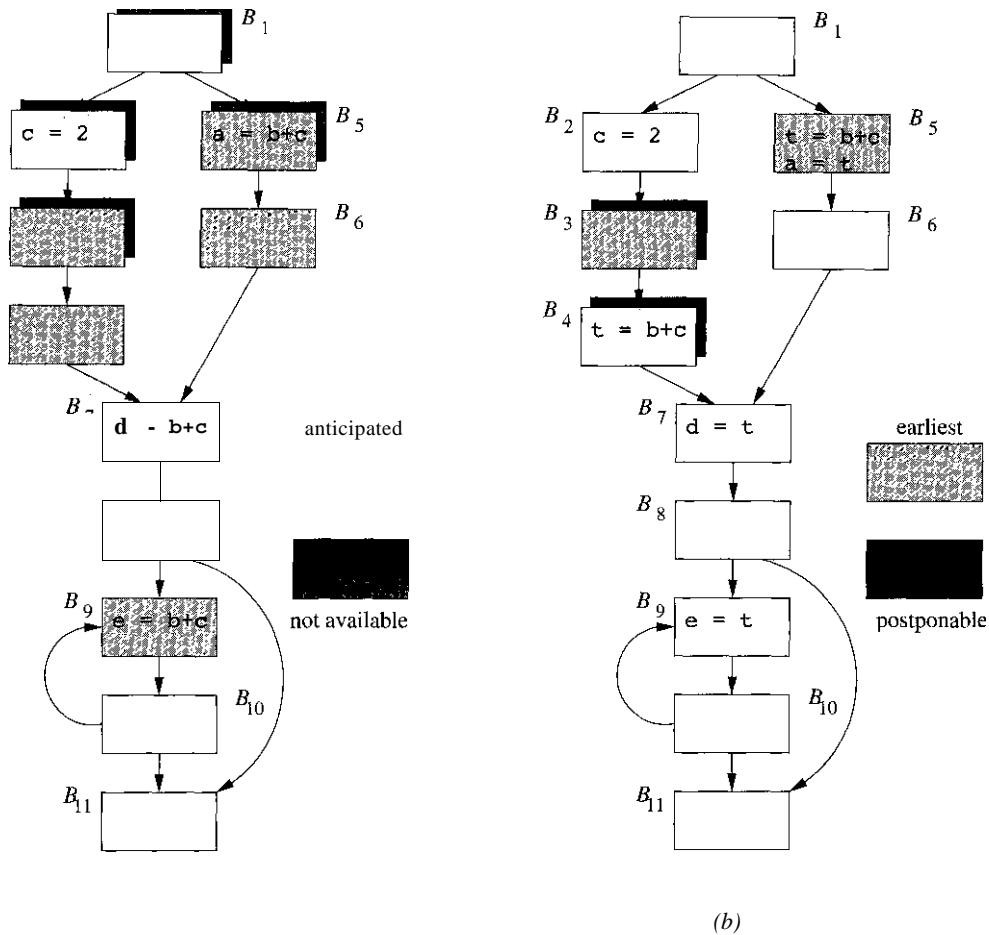

Figure 9.33: Flow graph of Example 9.30

path, the meet operator is set intersection. Consequently, the interior points must be initialized to the universal set  $U$ , as was discussed for the available-expressions problem in Section 9.2.6.

### Available Expressions

At the end of this second step, copies of an expression will be placed at program points where the expression is first anticipated. If that is the case, an expression will be *available* at program point  $p$  if it is anticipated along all paths reaching  $p$ . This problem is similar to available-expressions described in Section 9.2.6. The transfer function used here is slightly different though. An expression is available on exit from a block if it is

	(a) Anticipated Expressions	(b) Available Expressions
Domain	Sets of expressions	Sets of expressions
Direction	Backwards	Forwards
Transfer function	$IB(X) = e\text{-uses} \cup (x - e\text{-kill}_e)$	$IB(X) = "$ $(anticipated[B].in \cup x) - e\text{-kill}_e$
Boundary	$IN[EXIT] = 0$	$OUT[ENTRY] = '0$
Meet (A)	$\cap$	$\cap$
Equations	$IN[B] = f_e(OUT[B])$ $OUT[B] = \text{As}_{is,cc}(B) MS]$	$OUT[B] = l_e(IN[B])$ $IN[\xi] = \bigwedge_{s \in succ(b)} OUT[P]$
Initialization	$W[B] = U$	$OUT[\xi] = U$
	(c) Postponable Expressions	(d) Used Expressions
Domain	Sets of expressions	Sets of expressions
Direction	Forwards	Backwards
Transfer function	$IB(X) = (earliest[B] \cup x) - ejuse_e$	$/B(X) = (ejuse_e \cup x) - latest[B]$
Boundary	$OUT[ENTRY] = 0$	$IN[EXIT] = 0$
Meet (A)	$\cap$	$\cup$
Equations	$OUT[\xi] = f_e(m[B])$ $m[B] = \text{Ap}_{t \text{ pred}(B)} OUT[P]$	$IN[\xi] = l_e(OUT[f1])$ $OUT[B] = \bigwedge_{s \in succ(b)} m[S]$
Initialization	$OUT[5] = U$	$IN[B] = 0$

$$\begin{aligned}
 earliest[B] &= anticipated[B].in - available[B].in \\
 latest[B] &= (earliest[B] \cup postponable[B].in) \cap \\
 &\quad (ejuse_e \cup \bigwedge_{S \in succ[B]} (earliest[S] \cup postponable[S].in))
 \end{aligned}$$

Figure 9.34: Four data-flow passes in partial-redundancy elimination



## Completing the Square

Anticipated expressions (also called "very busy expressions" elsewhere) is a type of data-flow analysis we have not seen previously. While we have seen backwards-flowing frameworks such as live-variable analysis (Sect. 9.2.5), and we have seen frameworks where the meet is intersection such as available expressions (Sect. 9.2.6), this is the first example of a useful analysis that has both properties. Almost all analyses we use can be placed in one of four groups, depending on whether they flow forwards or backwards, and depending on whether they use union or intersection for the meet. Notice also that the union analyses always involve asking about whether there exists a path along which something is true, while the intersection analyses ask whether something is true along all paths.

1. Either
  - (a) Available, or
  - (b) In the set of anticipated expressions upon entry (i.e., it *could* be made available if we chose to compute it here),
 and
2. Not killed in the block.

The data-flow equations for available expressions are shown in Fig 9.34(b). To avoid confusing the meaning of IN, we refer to the result of an earlier analysis by appending "[JBj.m]" to the name of the earlier analysis.

With the earliest placement strategy, the set of expressions placed at block  $B$ , i.e.,  $earliest[B]$ , is defined as the set of anticipated expressions that are not yet available. That is,

$$earliest[B] = anticipated[B].in - available[B].in.$$

Example 9.31: The expression  $b + c$  in the flow graph in Figure 9.35 is not anticipated at the entry of block  $B_1$ , but is anticipated at the entry of block  $B_2$ . It is, however, not necessary to compute the expression  $b + c$  in block  $B_4$ , because the expression is already available due to block  $B_2$ . •

Example 9.32: Shown with dark shadows in Fig. 9.33(a) are the blocks for which expression  $b + c$  is not available; they are  $B_1, B_2, B_3$ , and  $B_5$ . The early-placement positions are represented by the lightly shaded boxes with dark shadows, and are thus blocks  $B_4$  and  $B_6$ . Note, for instance, that  $b + c$  is considered available on entry to  $B_4$ , because there is a path  $B_1 \rightarrow B_2 \rightarrow B_3 \rightarrow B_4$  along which  $b + c$  is anticipated at least once — at  $B_2$  in this case — and since the beginning of  $B_2$ , neither  $b$  nor  $c$  was recomputed. •

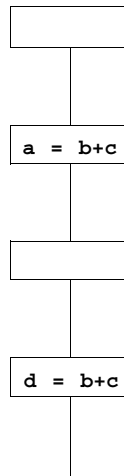

Figure 9.35: Flow graph for Example 9.31 illustrating the use of availability

### Postponable Expressions

The third step postpones the computation of expressions as much as possible while preserving the original program semantics and minimizing redundancy. Example 9.33 illustrates the importance of this step.

**Example 9.33:** In the flow graph shown in Figure 9.36, the expression  $b + c$  is computed twice along the path  $B_i \rightarrow B_j \rightarrow BQ \rightarrow B_r$ . The expression  $b + c$  is anticipated even at the beginning of block  $B_i$ . If we compute the expression as soon as it is anticipated, we would have computed the expression  $b + c$  in  $B_i$ . The result would have to be saved from the beginning, through the execution of the loop comprising blocks  $B_i$  and  $BQ$ , until it is used in block  $B_r$ . Instead we can delay the computation of expression  $b + c$  until the beginning of  $B_j$  and until the flow of control is about to transition from  $B_i$  to  $BQ$ . •

Formally, an expression  $x + y$  is *postponable* to a program point  $p$  if an early placement of  $x + y$  is encountered along every path from the entry node to  $p$ , and there is no subsequent use of  $x + y$  after the last such placement.

**Example 9.34:** Let us again consider expression  $b + c$  in Fig. 9.33. The two earliest points for  $b + c$  are  $B_i$  and  $B_j$ ; note that these are the two blocks that are both lightly and darkly shaded in Fig. 9.33(a), indicating that  $b + c$  is both anticipated and not available for these blocks, and only these blocks. We cannot postpone  $b + c$  from  $B_i$  to  $BQ$ , because  $b + c$  is used in  $B_i$ . We can postpone it from  $B_j$  to  $B_r$  however.

But we cannot postpone  $b + c$  from  $B_i$  to  $B_r$ . The reason is that, although  $b + c$  is not used in  $B_i$ , placing its computation at  $B_i$  instead would lead to a

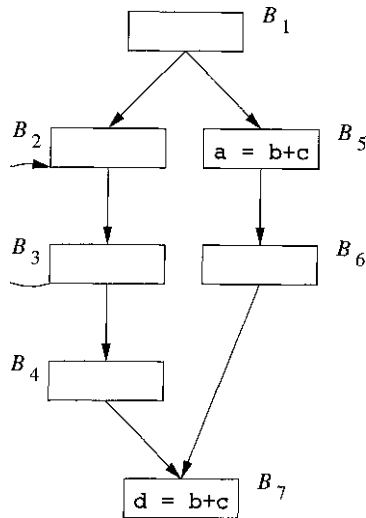

Figure 9.36: Flow graph for Example 9.33 to illustrate the need for postponing an expression

redundant computation of  $b + c$  along the path  $B_5 \rightarrow B_6 \rightarrow B_7$ . As we shall see,  $B_5$  is one of the latest places we can compute  $b + c$ . •

The data-flow equations for the postponable-expressions problem are shown in Fig 9.34(c). The analysis is a forward pass. We cannot "postpone" an expression to the entry of the program, so  $\text{OUT}[\text{ENTRY}] = 0$ . An expression is postponable to the exit of block  $B$  if it is not used in the block, and either it is postponable to the entry of  $B$  or it is in  $\text{earliest}[B]$ . An expression is not postponable to the entry of a block unless all its predecessors include the expression in their *postponable* sets at their exits. Thus, the meet operator is set intersection, and the interior points must be initialized to the top element of the semilattice — the universal set.

Roughly speaking, an expression is placed at the *frontier* where an expression transitions from being postponable to not being postponable. More specifically, an expression  $e$  may be placed at the beginning of a block  $B$  only if the expression is in  $B$ 's *earliest* or *postponable* set upon entry. In addition,  $B$  is in the postponement frontier of  $e$  if one of the following holds:

1.  $e$  is not in  $\text{postponable}[B].\text{out}$ . In other words,  $e$  is in  $\text{ejuses-}$
2.  $e$  cannot be postponed to one of its successors. In other words, there exists a successor of  $B$  such that  $e$  is not in the *earliest* or *postponable* set upon entry to that successor.

Expression  $e$  can be placed at the front of block  $B$  in either of the above scenarios because of the new blocks introduced by the preprocessing step in the algorithm.

**Example 9.35:** Fig. 9.33(b) shows the result of the analysis. The light-shaded boxes represent the blocks whose *earliest* set includes  $b + c$ . The dark shadows indicate those that include  $b + c$  in their *postponable* set. The latest placements of the expressions are thus the entries of blocks  $B_i$  and  $B_s$ , since

1.  $b + c$  is in the *postponable* set of  $\_B_i$ , but not  $B_7$ , and
2.  $IV_s$  *earliest* set includes  $b + c$  and it uses  $b + c$ .

The expression is stored into the temporary variable  $t$  in blocks  $B_i$  and  $B_s$ , and  $t$  is used in place of  $b + c$  everywhere else, as shown in the figure. •

### Used Expressions

Finally, a backward pass is used to determine if the temporary variables introduced are used beyond the block they are in. We say that an expression is *used* at point  $p$  if there exists a path leading from  $p$  that uses the expression before the value is reevaluated. This analysis is essentially liveness analysis (for expressions, rather than for variables).

The data-flow equations for the used expressions problem are shown in Fig 9.34(d). The analysis is a backward pass. A used expression at the exit of a block  $B$  is a used expression on entry only if it is not in the *latest* set. A block generates, as new uses, the set of expressions in  $e_{juse}^{\wedge}$ . At the exit of the program, none of the expressions are used. Since we are interested in finding expressions that are used by any subsequent path, the meet operator is set union. Thus, the interior points must be initialized with the top element of the semilattice — the empty set.

### Putting it All Together

All the steps of the algorithm are summarized in Algorithm 9.36.

**Algorithm 9.36:** Lazy code motion.

**INPUT:** A flow graph for which  $e_{juses}$  and  $e_{jstill}$  have been computed for each block  $B$ .

**OUTPUT:** A modified flow graph satisfying the four lazy code motion conditions in Section 9.5.3.

#### METHOD:

1. Insert an empty block along all edges entering a block with more than one predecessor.
2. Find  $anticipated[B].in$  for all blocks  $B$ , as defined in Fig. 9.34(a).
3. Find  $available[B].in$  for all blocks  $B$  as defined in Fig. 9.34(b).

4. Compute the earliest placements for all blocks  $B$ :

$$earliest[B] = anticipated[B].in - available[B].in$$

5. Find  $postponable[B].in$  for all blocks  $B$  as defined in Fig. 9.34(c).  
 6. Compute the latest placements for all blocks  $B$ :

$$latest[B] = (earliest[B] \cup postponable[B].in) \cap \left( e\_use_B \cup \neg \left( \bigcap_{S \text{ in } succ[B]} (earliest[S] \cup postponable[S].in) \right) \right)$$

Note that  $\neg$  denotes complementation with respect to the set of all expressions computed by the program.

7. Find  $used[B].out$  for all blocks  $B$ , as defined in Fig. 9.34(d).  
 8. For each expression, say  $x+y$ , computed by the program, do the following:
- Create a new temporary, say  $t$ , for  $x + y$ .
  - For all blocks  $B$  such that  $x + y$  is in  $latest[B] \cap used[B].out$ , add  $t = x+y$  at the beginning of  $B$ .
  - For all blocks  $B$  such that  $x + y$  is in

$$e\_uses \cap (-latest[B] \cup used.out[B])$$

replace every original  $x + y$  by  $t$ .

•

### Summary

Partial-redundancy elimination finds many different forms of redundant operations in one unified algorithm. This algorithm illustrates how multiple data-flow problems can be used to find optimal expression placement.

- The placement constraints are provided by the anticipated-expressions analysis, which is a *backwards* data-flow analysis with a set-intersection meet operator, as it determines if expressions are used *subsequent* to each program point on *all* paths.
- The earliest placement of an expression is given by program points where the expression is anticipated but is not available. Available expressions are found with a *forwards* data-flow analysis with a set-intersection meet operator that computes if an expression has been anticipated *before* each program point along *all* paths.

3. The latest placement of an expression is given by program points where an expression can no longer be postponed. Expressions are postponable at a program point if for *all* paths *reaching* the program point, no use of the expression has been encountered. Postponable expressions are found with a *forwards* data-flow analysis with a set-intersection meet operator.
4. Temporary assignments are eliminated unless they are used by *some* path *subsequently*. We find used expressions with a *backwards* data-flow analysis, this time with a set-union meet operator.

### 9.5.6 Exercises for Section 9.5

**Exercise 9.5.1:** For the flow graph in Fig. 9.37:

- a) Compute *anticipated* for the beginning and end of each block.
- b) Compute *available* for the beginning and end of each block.
- c) Compute *earliest* for each block.
- d) Compute *postponable* for the beginning and end of each block.
- e) Compute *used* for the beginning and end of each block.
- f) Compute *latest* for each block.
- g) Introduce temporary variable  $t$ ; show where it is computed and where it is used.

**Exercise 9.5.2:** Repeat Exercise 9.5.1 for the flow graph of Fig. 9.10 (see the exercises to Section 9.1). You may limit your analysis to the expressions  $a + 6$ ,  $c - a$ , and  $b * d$ .

**!! Exercise 9.5.3:** The concepts discussed in this section can also be applied to eliminate partially dead code. A definition of a variable is *partially dead* if the variable is live on some paths and not others. We can optimize the program execution by only performing the definition along paths where the variable is live. Unlike partial-redundancy elimination, where expressions are moved before the original, the new definitions are placed after the original. Develop an algorithm to move partially dead code, so expressions are evaluated only where they will eventually be used.

## 9.6 Loops in Flow Graphs

In our discussion so far, loops have not been handled differently; they have been treated just like any other kind of control flow. However, loops are important because programs spend most of their time executing them, and optimizations

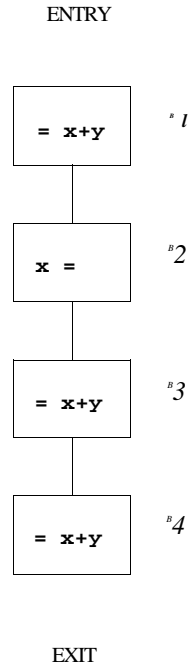

Figure 9.37: Flow graph for Exercise 9.5.1

that improve the performance of loops can have a significant impact. Thus, it is essential that we identify loops and treat them specially.

Loops also affect the running time of program analyses. If a program does not contain any loops, we can obtain the answers to data-flow problems by making just one pass through the program. For example, a forward data-flow problem can be solved by visiting all the nodes once, in topological order.

In this section, we introduce the following concepts: dominators, depth-first ordering, back edges, graph depth, and reducibility. Each of these is needed for our subsequent discussions on finding loops and the speed of convergence of iterative data-flow analysis.

### 9.6.1 Dominators

We say node  $d$  of a flow graph *dominates* node  $n$ , written  $d \text{ dom } n$ , if every path from the entry node of the flow graph to  $n$  goes through  $d$ . Note that under this definition, every node dominates itself.

**Example 9.37:** Consider the flow graph of Fig. 9.38, with entry node 1. The entry node dominates every node (this statement is true for every flow graph). Node 2 dominates only itself, since control can reach any other node along a path that begins with  $1 \rightarrow 3$ . Node 3 dominates all but 1 and 2. Node 4 dominates

all but 1, 2 and 3, since all paths from 1 must begin with 1->2->3->4 or 1->3->4. Nodes 5 and 6 dominate only themselves, since flow of control can skip around either by going through the other. Finally, 7 dominates 7, 8, 9, and 10; 8 dominates 8, 9, and 10; 9 and 10 dominate only themselves. •

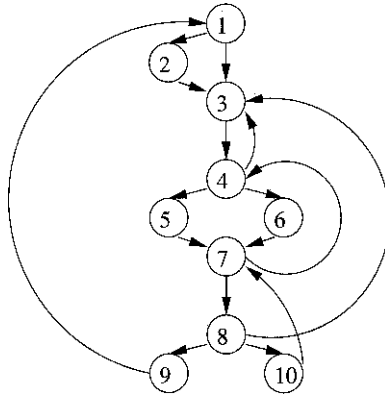

Figure 9.38: A flow graph

A useful way of presenting dominator information is in a tree, called the *dominator tree*, in which the entry node is the root, and each node  $d$  dominates only its descendants in the tree. For example, Fig. 9.39 shows the dominator tree for the flow graph of Fig. 9.38.

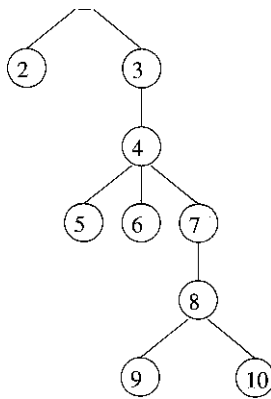

Figure 9.39: Dominator tree for flow graph of Fig. 9.38

The existence of dominator trees follows from a property of dominators: each node  $n$  has a unique *immediate dominator*  $m$  that is the last dominator of  $n$  on any path from the entry node to  $n$ . In terms of the *dom* relation, the



immediate dominator  $m$  has that property that if  $d \wedge n$  and  $d \text{ dom } n$ , then  $d \text{ dom } m$ .

We shall give a simple algorithm for computing the dominators of every node  $n$  in a flow graph, based on the principle that if  $p_1, p_2, \dots, p_k$  are all the predecessors of  $n$ , and  $d \wedge n$ , then  $d \text{ dom } n$  if and only if  $d \text{ dom } p_i$  for each  $i$ . This problem can be formulated as a forward data-flow analysis. The data-flow values are sets of basic blocks. A node's set of dominators, other than itself, is the intersection of the dominators of all its predecessors; thus the meet operator is set intersection. The transfer function for block  $B$  simply adds  $B$  itself to the set of input nodes. The boundary condition is that the **ENTRY** node dominates itself. Finally, the initialization of the interior nodes is the universal set, that is, the set of all nodes.

Algorithm 9.38: Finding dominators.

**INPUT:** A flow graph  $G$  with set of nodes  $N$ , set of edges  $E$  and entry node **ENTRY**.

**OUTPUT:**  $D(n)$ , the set of nodes that dominate node  $n$ , for all nodes  $n$  in  $N$ .

**METHOD:** Find the solution to the data-flow problem whose parameters are shown in Fig. 9.40. The basic blocks are the nodes.  $D(n) = \mathbf{OUT}[n]$  for all  $n$  in  $N$ . •

Finding dominators using this data-flow algorithm is efficient. Nodes in the graph need to be visited only a few times, as we shall see in Section 9.6.7.

	Dominators
Domain	The power set of $N$
Direction	Forwards
Transfer function	$f_n(x) = x \cup \{B\}$
Boundary	$\mathbf{OUT}[\mathbf{ENTRY}] = \{\mathbf{ENTRY}\}$
Meet ( $\mathbf{A}$ )	$\cap$
Equations	$\mathbf{OUT}[5] = \bigcap (\mathbf{IN}[J3])$ $m[B] = \bigcap_{p \in \text{pred}(B)} \mathbf{OUT}[P]$
Initialization	$\mathbf{OUT}[B] = N$

Figure 9.40: A data-flow algorithm for computing dominators

Example 9.39: Let us return to the flow graph of Fig. 9.38, and suppose the for-loop of lines (4) through (6) in Fig. 9.23 visits the nodes in numerical order. Let  $D(n)$  be the set of nodes in  $\mathbf{OUT}[n]$ . Since 1 is the entry node,  $D(1)$  was assigned  $\{1\}$  at line (1). Node 2 has only 1 for a predecessor, so

### Properties of the *dom* Relation

A key observation about dominators is that if we take any acyclic path from the entry to node  $n$ , then all the dominators of  $n$  appear along this path, and moreover, they must appear *in the same order* along any such path. To see why, suppose there were one acyclic path  $P_1$  to  $n$  along which dominators  $a$  and  $b$  appeared in that order and another path  $P_2$  to  $n$ , along which  $b$  preceded  $a$ . Then we could follow  $P_1$  to  $a$  and  $P_2$  to  $n$ , thereby avoiding  $b$  altogether. Thus,  $b$  would not really dominate  $a$ .

This reasoning allows us to prove that *dom* is transitive: if  $a \text{ dom } b$  and  $b \text{ dom } c$ , then  $a \text{ dom } c$ . Also, *dom* is antisymmetric: it is never possible that both  $a \text{ dom } b$  and  $b \text{ dom } a$  hold, if  $a \neq b$ . Moreover, if  $a$  and  $b$  are two dominators of  $n$ , then either  $a \text{ dom } b$  or  $b \text{ dom } a$  must hold. Finally, it follows that each node  $n$  except the entry must have a unique immediate dominator — the dominator that appears closest to  $n$  along any acyclic path from the entry to  $n$ .

$D(2) = \{2\} \cup UD(1)$ . Thus,  $D(2)$  is set to  $\{1, 2\}$ . Then node 3, with predecessors 1, 2, 4, and 8, is considered. Since all the interior nodes are initialized with the universal set  $N$ ,

$$\mathcal{E}(3) = \{3\} \cup (\{1\} \cap \{1,2\} \cap \{1,2,\dots,10\} \cap \{1,2,\dots,10\}) = \{1,3\}$$

The remaining calculations are shown in Fig. 9.41. Since these values do not change in the second iteration through the outer loop of lines (3) through (6) in Fig. 9.23(a), they are the final answers to the dominator problem. •

$$\begin{aligned} D(4) &= \{4\} \cup (D(3) \cap D(7)) = \{4\} \cup (\{1,3\} \cap \{1,2,\dots,10\}) = \{1,3,4\} \\ D(5) &= \{5\} \cup P(4) = \{5\} \cup \{1,3,4\} = \{1,3,4,5\} \\ D(6) &= \{6\} \cup O(4) = \{6\} \cup \{1,3,4\} = \{1,3,4,6\} \\ D(7) &= \{7\} \cup (U(5) \cap D(6) \cap \mathcal{E}(10)) \\ &= \{7\} \cup (\{1,3,4,5\} \cap \{1,3,4,6\} \cap \{1,2,\dots,10\}) = \{1,3,4,7\} \\ D(8) &= \{8\} \cup D(7) = \{8\} \cup \{1,3,4,7\} = \{1,3,4,7,8\} \\ D(9) &= \{9\} \cup D(8) = \{9\} \cup \{1,3,4,7,8\} = \{1,3,4,7,8,9\} \\ D(10) &= \{10\} \cup \mathcal{E}(8) = \{10\} \cup \{1,3,4,7,8\} = \{1,3,4,7,8,10\} \end{aligned}$$

Figure 9.41: Completion of the dominator calculation for Example 9.39

### 9.6.2 Depth-First Ordering

As introduced in Section 2.3.4, a *depth-first search* of a graph visits all the nodes in the graph once, by starting at the entry node and visiting the nodes as far away from the entry node as quickly as possible. The route of the search in a depth-first search forms a *depth-first spanning tree* (DFST). Recall from Section 2.3.4 that a preorder traversal visits a node before visiting any of its children, which it then visits recursively in left-to-right order. Also, a postorder traversal visits a node's children, recursively in left-to-right order, before visiting the node itself.

There is one more variant ordering that is important for flow-graph analysis: a *depth-first ordering* is the reverse of a postorder traversal. That is, in a depth-first ordering, we visit a node, then traverse its rightmost child, the child to its left, and so on. However, before we build the tree for the flow graph, we have choices as to which successor of a node becomes the rightmost child in the tree, which node becomes the next child, and so on. Before we give the algorithm for depth-first ordering, let us consider an example.

**Example 9.40:** One possible depth-first presentation of the flow graph in Fig. 9.38 is illustrated in Fig. 9.42. Solid edges form the tree; dashed edges are the other edges of the flow graph. A depth-first traversal of the tree is given by: 1 → 3 → 4 → 6 → 7 → 8 → 10, then back to 8, then to 9. We go back to 8 once more, retreating to 7, 6, and 4, and then forward to 5. We retreat from 5 back to 4, then back to 3 and 1. From 1 we go to 2, then retreat from 2, back to 1, and we have traversed the entire tree.

The preorder sequence for the traversal is thus

$$1, 3, 4, 6, 7, 8, 10, 9, 5, 2.$$

The postorder sequence for the traversal of the tree in Fig. 9.42 is

$$10, 9, 8, 7, 6, 5, 4, 3, 2, 1.$$

The depth-first ordering, which is the reverse of the postorder sequence, is

$$1, 2, 3, 4, 5, 6, 7, 8, 9, 10.$$

•

We now give an algorithm that finds a depth-first spanning tree and a depth-first ordering of a graph. It is this algorithm that finds the DFST in Fig. 9.42 from Fig. 9.38.

**Algorithm 9.41:** Depth-first spanning tree and depth-first ordering.

**INPUT:** A flow graph  $G$ .

**OUTPUT:** A DFST  $T$  of  $G$  and an ordering of the nodes of  $G$ .

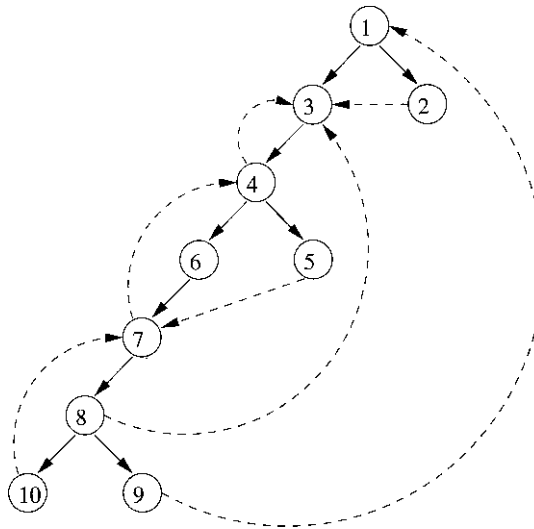

Figure 9.42: A depth-first presentation of the flow graph in Fig. 9.38

**METHOD:** We use the recursive procedure  $search(n)$  of Fig. 9.43. The algorithm initializes all nodes of  $G$  to "unvisited," then calls  $search(no)$ , where  $no$  is the entry. When it calls  $search(n)$ , it first marks  $n$  "visited" to avoid adding  $n$  to the tree twice. It uses  $c$  to count from the number of nodes of  $G$  down to 1, assigning depth-first numbers  $dfn[n]$  to nodes  $n$  as we go. The set of edges  $T$  forms the depth-first spanning tree for  $G$ . •

**Example 9.42:** For the flow graph in Fig. 9.42, Algorithm 9.41 sets  $c$  to 10 and begins the search by calling  $search(1)$ . The rest of the execution sequence is shown in Fig. 9.44. •

### 9.6.3 Edges in a Depth-First Spanning Tree

When we construct a DFST for a flow graph, the edges of the flow graph fall into three categories.

1. There are edges, called **advancing edges**, that go from a node  $m$  to a proper descendant of  $m$  in the tree. All edges in the DFST itself are advancing edges. There are no other advancing edges in Fig. 9.42, but, for example, if  $4 \rightarrow 8$  were an edge, it would be in this category.
2. There are edges that go from a node  $m$  to an ancestor of  $m$  in the tree (possibly to  $m$  itself). These edges we shall term **retreating edges**. For example,  $4 \rightarrow 3$ ,  $7 \rightarrow 4$ ,  $10 \rightarrow 7$  and  $9 \rightarrow 1$  are the retreating edges in Fig. 9.42.

```

void search(n) {
    mark n "visited";
    for (each successor s of n)
        if (s is "unvisited") {
            add edge  $n \rightarrow s$  to T;
            search(s);
        }
    dfn[n] = c;
    c = c - 1;
}

mainQ {
    T = 0; /* set of edges */
    for (each node n of G)
        mark n "unvisited";
    c = number of nodes of G;
    search(no);
}

```

Figure 9.43: Depth-first search algorithm

- There are edges  $m \rightarrow n$  such that neither *m* nor *n* is an ancestor of the other in the DFST. Edges  $2 \rightarrow 3$  and  $5 \rightarrow 7$  are the only such examples in Fig. 9.42. We call these edges *cross edges*. An important property of cross edges is that if we draw the DFST so children of a node are drawn from left to right in the order in which they were added to the tree, then all cross edges travel from right to left.

It should be noted that  $m \rightarrow n$  is a retreating edge if and only if  $dfn[m] > dfn[n]$ . To see why, note that if *m* is a descendant of *n* in the DFST, then  $search(m)$  terminates before  $search(n)$ , so  $dfn[m] > dfn[n]$ . Conversely, if  $dfn[m] > dfn[n]$ , then  $search(m)$  terminates before  $search(n)$ , or  $m = n$ . But  $search(n)$  must have begun before  $search(m)$  if there is an edge  $m \rightarrow n$ , or else the fact that *n* is a successor of *m* would have made *n* a descendant of *m* in the DFST. Thus the time  $search(m)$  is active is a subinterval of the time  $search(n)$  is active, from which it follows that *n* is an ancestor of *m* in the DFST.

### 9.6.4 Back Edges and Reducibility

A *back edge* is an edge  $a \rightarrow b$  whose head *b* dominates its tail *a*. For any flow graph, every back edge is retreating, but not every retreating edge is a back edge. A flow graph is said to be *reducible* if all its retreating edges in any depth-first spanning tree are also back edges. In other words, if a graph is reducible, then all the DFST's have the same set of retreating edges, and

Call <i>search</i> (1)	Node 1 has two successors. Suppose $s = 3$ is considered first; add edge $1 \rightarrow 3$ to $T$ .
Call <i>search</i> (3)	Add edge $3 \rightarrow 4$ to $T$ .
Call <i>search</i> (4)	Node 4 has two successors, 4 and 6. Suppose $s = 6$ is considered first; add edge $4 \rightarrow 6$ to $T$ .
Call <i>search</i> (6)	Add $6 \rightarrow 7$ to $T$ .
Call <i>search</i> (7)	Node 7 has two successors, 4 and 8. But 4 is already marked "visited" by <i>search</i> (4), so do nothing when $s = 4$ . For $s = 8$ , add edge $7 \rightarrow 8$ to $T$ .
Call <i>search</i> (8)	Node 8 has two successors, 9 and 10. Suppose $s = 10$ is considered first; add edge $8 \rightarrow 10$ .
Call <i>search</i> (10)	10 has a successor, 7, but 7 is already marked "visited." Thus, <i>search</i> (10) completes by setting $dfn[10] = 10$ and $c = 9$ .
Return to <i>search</i> (8)	Set $s = 9$ and add edge $8 \rightarrow 9$ to $T$ .
Call <i>search</i> (9)	The only successor of 9, node 1, is already "visited," so set $dfn[9] = 9$ and $c = 8$ .
Return to <i>search</i> (8)	The last successor of 8, node 3, is "visited," so do nothing for $s = 3$ . At this point, all successors of 8 have been considered, so set $dfn[8] = 8$ and $c = 7$ .
Return to <i>search</i> (7)	All of 7's successors have been considered, so set $dfn[7] = 7$ and $c = 6$ .
Return to <i>search</i> (6)	Similarly, 6's successors have been considered, so set $dfn[6] = 6$ and $c = 5$ .
Return to <i>search</i> (4)	Successor 3 of 4 has been "visited," but 5 has not, so add $4 \rightarrow 5$ to the tree.
Call <i>search</i> (5)	Successor 7 of 5 has been "visited," thus set $dfn[5] = 5$ and $c = 4$ .
Return to <i>search</i> (4)	All successors of 4 have been considered, set $dfn[4] = 4$ and $c = 3$ .
Return to <i>search</i> (1)	Set $dfn[1] = 1$ and $c = 2$ .
Return to <i>search</i> (1)	2 has not been visited yet, so add $1 \rightarrow 2$ to $T$ .
Call <i>search</i> (2)	Set $dfn[2] = 2$ , $c = 1$ .
Return to <i>search</i> (1)	Set $dfn[1] = 1$ and $c = 0$ .

Figure 9.44: Execution of Algorithm 9.41 on the flow graph in Fig. 9.43

### Why Are Back Edges Retreating Edges?

Suppose  $a \rightarrow b$  is a back edge; i.e., its head dominates its tail. The sequence of calls of the function *search* in Fig. 9.43 that lead to node  $a$  must be a path in the flow graph. This path must, of course, include any dominator of  $a$ . It follows that a call to *search(b)* must be open when *search(a)* is called. Therefore  $b$  is already in the tree when  $a$  is added to the tree, and  $a$  is added as a descendant of  $b$ . Therefore,  $a \rightarrow b$  must be a retreating edge.

those are exactly the back edges in the graph. If the graph is *nonreducible* (not reducible), however, all the back edges are retreating edges in any DFST, but each DFST may have additional retreating edges that are not back edges. These retreating edges may be different from one DFST to another. Thus, if we remove all the back edges of a flow graph and the remaining graph is cyclic, then the graph is nonreducible, and conversely.

Flow graphs that occur in practice are almost always reducible. Exclusive use of structured flow-of-control statements such as if-then-else, while-do, continue, and break statements produces programs whose flow graphs are always reducible. Even programs written using goto statements often turn out to be reducible, as the programmer logically thinks in terms of loops and branches.

Example 9.43: The flow graph of Fig. 9.38 is reducible. The retreating edges in the graph are all back edges; that is, their heads dominate their respective tails. •

Example 9.44: Consider the flow graph of Fig. 9.45, whose initial node is 1. Node 1 dominates nodes 2 and 3, but 2 does not dominate 3, nor vice-versa. Thus, this flow graph has no back edges, since no head of any edge dominates its tail. There are two possible depth-first spanning trees, depending on whether we choose to call *search(2)* or *search(3)* first, from *search(1)*. In the first case, edge  $3 \rightarrow 2$  is a retreating edge but not a back edge; in the second case,  $2 \rightarrow 3$  is the retreating-but-not-back edge. Intuitively, the reason this flow graph is not reducible is that the cycle 2-3 can be entered at two different places, nodes 2 and 3. •

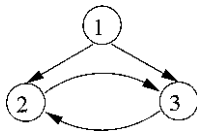

Figure 9.45: The canonical nonreducible flow graph

### 9.6.5 Depth of a Flow Graph

Given a depth-first spanning tree for the graph, the *depth* is the largest number of retreating edges on any cycle-free path. We can prove the depth is never greater than what one would intuitively call the depth of loop nesting in the flow graph. If a flow graph is reducible, we may replace "retreating" by "back" in the definition of "depth," since the retreating edges in any DFST are exactly the back edges. The notion of depth then becomes independent of the DFST actually chosen, and we may truly speak of the "depth of a flow graph," rather than the depth of a flow graph in connection with one of its depth-first spanning trees.

Example 9.45: In Fig. 9.42, the depth is 3, since there is a path

$$10 \rightarrow 7 \rightarrow 4 \rightarrow 3$$

with three retreating edges, but no cycle-free path with four or more retreating edges. It is a coincidence that the "deepest" path here has only retreating edges; in general we may have a mixture of retreating, advancing, and cross edges in a deepest path. •

### 9.6.6 Natural Loops

Loops can be specified in a source program in many different ways: they can be written as for-loops, while-loops, or repeat-loops; they can even be defined using labels and goto statements. From a program-analysis point of view, it does not matter how the loops appear in the source code. What matters is whether they have the properties that enable easy optimization. In particular, we care about whether a loop has a single-entry node; if it does, compiler analyses can assume certain initial conditions to hold at the beginning of each iteration through the loop. This opportunity motivates the need for the definition of a "natural loop."

A *natural loop* is defined by two essential properties.

1. It must have a single-entry node, called the *header*. This entry node dominates all nodes in the loop, or it would not be the sole entry to the loop.
2. There must be a back edge that enters the loop header. Otherwise, it is not possible for the flow of control to return to the header directly from the "loop"; i.e., there really is no loop.

Given a back edge  $n \rightarrow d$ , we define the *natural loop of the edge* to be  $d$  plus the set of nodes that can reach  $n$  without going through  $d$ . Node  $d$  is the header of the loop.

Algorithm 9.46 : Constructing the natural loop of a back edge.

**INPUT:** A flow graph  $G$  and a back edge  $n \rightarrow d$ .



**OUTPUT:** The set *loop* consisting of all nodes in the natural loop of  $n \rightarrow d$ .

**METHOD:** Let *loop* be  $\{n, d\}$ . Mark  $d$  as "visited," so that the search does not reach beyond  $d$ . Perform a depth-first search on the reverse control-flow graph starting with node  $n$ . Insert all the nodes visited in this search into *loop*. This procedure finds all the nodes that reach  $n$  without going through  $d$ . •

Example 9.47: In Fig. 9.38, there are five back edges, those whose heads dominate their tails:  $10 \rightarrow 7$ ,  $7 \rightarrow 4$ ,  $4 \rightarrow 3$ ,  $8 \rightarrow 3$  and  $9 \rightarrow 1$ . Note that these are exactly the edges that one would think of as forming loops in the flow graph.

Back edge  $10 \rightarrow 7$  has natural loop  $\{7, 8, 10\}$ , since 8 and 10 are the only nodes that can reach 10 without going through 7. Back edge  $7 \rightarrow 4$  has a natural loop consisting of  $\{4, 5, 6, 7, 8, 10\}$  and therefore contains the loop of  $10 \rightarrow 7$ . We thus assume the latter is an inner loop contained inside the former.

The natural loops of back edges  $4 \rightarrow 3$  and  $8 \rightarrow 3$  have the same header, node 3, and they also happen to have the same set of nodes:  $\{3, 4, 5, 6, 7, 8, 10\}$ . We shall therefore combine these two loops as one. This loop contains the two smaller loops discovered earlier.

Finally, the edge  $9 \rightarrow 1$  has as its natural loop the entire flow graph, and therefore is the outermost loop. In this example, the four loops are nested within one another. It is typical, however, to have two loops, neither of which is a subset of the other. •

In reducible flow graphs, since all retreating edges are back edges, we can associate a natural loop with each retreating edge. That statement does not hold for nonreducible graphs. For instance, the nonreducible flow graph in Fig. 9.45 has a cycle consisting of nodes 2 and 3. Neither of the edges in the cycle is a back edge, so this cycle does not fit the definition of a natural loop. We do not identify the cycle as a natural loop, and it is not optimized as such. This situation is acceptable, because our loop analyses can be made simpler by assuming that all loops have single-entry nodes, and nonreducible programs are rare in practice anyway.

By considering only natural loops as "loops," we have the useful property that unless two loops have the same header, they are either disjoint or one is nested within the other. Thus, we have a natural notion of *innermost loops*: loops that contain no other loops.

When two natural loops have the same header, as in Fig. 9.46, it is hard to tell which is the inner loop. Thus, we shall assume that when two natural loops have the same header, and neither is properly contained within the other, they are combined and treated as a single loop.

Example 9.48: The natural loops of the back edges  $3 \rightarrow 1$  and  $4 \rightarrow 1$  in Fig. 9.46 are  $\{1, 2, 3\}$  and  $\{1, 2, 4\}$ , respectively. We shall combine them into a single loop,  $\{1, 2, 3, 4\}$ .

However, were there another back edge  $2 \rightarrow 1$  in Fig. 9.46, its natural loop would be  $\{1, 2\}$ , a third loop with header 1. This set of nodes is properly

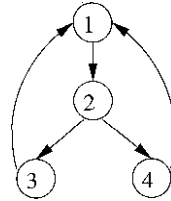

Figure 9.46: Two loops with the same header

contained within  $\{1, 2, 3, 4\}$ , so it would not be combined with the other natural loops, but rather treated as an inner loop, nested within. •

### 9.6.7 Speed of Convergence of Iterative Data-Flow Algorithms

We are now ready to discuss the speed of convergence of iterative algorithms. As discussed in Section 9.3.3, the maximum number of iterations the algorithm may take is the product of the height of the lattice and the number of nodes in the flow graph. For many data-flow analyses, it is possible to order the evaluation such that the algorithm converges in a much smaller number of iterations. The property of interest is whether all events of significance at a node will be propagated to that node along some acyclic path. Among the data-flow analyses discussed so far, reaching definitions, available expressions and live variables have this property, but constant propagation does not. More specifically:

- If a definition  $d$  is in  $\text{IN}[\mathcal{L}^?]$ , then there is some acyclic path from the block containing  $d$  to  $B$  such that  $d$  is in the  $\text{iN}$ 's and  $\text{OUT}$ 's all along that path.
- If an expression  $x + y$  is *not* available at the entrance to block  $B$ , then there is some acyclic path that demonstrates that either the path is from the entry node and includes no statement that kills or generates  $x + y$ , *or* the path is from a block that kills  $x + y$  and along the path there is no subsequent generation of  $x + y$ .
- If  $x$  is live on exit from block  $B$ , then there is an acyclic path from  $B$  to a use of  $x$ , along which there are no definitions of  $x$ .

We should check that in each of these cases, paths with cycles add nothing. For example, if a use of  $x$  is reached from the end of block  $B$  along a path with a cycle, we can eliminate that cycle to find a shorter path along which the use of  $x$  is still reached from  $B$ .

In contrast, constant propagation does not have this property. Consider a simple program that has one loop containing a basic block with statements

```

L:   a = b
      b = c
      c = 1
      goto L

```

The first time the basic block is visited,  $c$  is found to have constant value 1, but both  $a$  and  $b$  are undefined. Visiting the basic block the second time, we find that  $b$  and  $c$  have constant values 1. It takes three visits of the basic block for the constant value 1 assigned to  $c$  to reach  $a$ .

If all useful information propagates along acyclic paths, we have an opportunity to tailor the order in which we visit nodes in iterative data-flow algorithms, so that after relatively few passes through the nodes we can be sure information has passed along all the acyclic paths.

Recall from Section 9.6.3 that if  $a \rightarrow^* b$  is an edge, then the depth-first number of  $b$  is less than that of  $a$  only when the edge is a retreating edge. For forward data-flow problems, it is desirable to visit the nodes according to the depth-first ordering. Specifically, we modify the algorithm in Fig. 9.23(a) by replacing line (4), which visits the basic blocks in the flow graph with

```

for (each block  $B$  other than ENTRY, in depth-first order) {

```

Example 9.49 : Suppose we have a path along which a definition  $d$  propagates, such as

```

3   5 -> 19 -> 35 -> 16 -+ 23 -+ 45 -+ 4 -> 10   17

```

where integers represent the depth-first numbers of the blocks along the path. Then the first time through the loop of lines (4) through (6) in the algorithm in Fig. 9.23(a),  $d$  will propagate from OUT[3] to IN[5] to OUT[5], and so on, up to OUT[35]. It will not reach IN[16] on that round, because as 16 precedes 35, we had already computed IN[16] by the time  $d$  was put in OUT[35]. However, the next time we run through the loop of lines (4) through (6), when we compute IN[16],  $d$  will be included because it is in OUT[35]. Definition  $d$  will also propagate to OUT[16], IN[23], and so on, up to OUT[45], where it must wait because IN[4] was already computed on this round. On the third pass,  $d$  travels to IN[4], OUT[4], IN[10], OUT[10], and IN[17], so after three passes we establish that  $d$  reaches block 17. •

It should not be hard to extract the general principle from this example. If we use depth-first order in Fig. 9.23(a), then the number of passes needed to propagate any reaching definition along any acyclic path is no more than one greater than the number of edges along that path that go from a higher numbered block to a lower numbered block. Those edges are exactly the retreating edges, so the number of passes needed is one plus the depth. Of course Algorithm 9.11 does not detect the fact that all definitions have reached wherever they can reach, until one more pass has yielded no changes. Therefore, the upper bound on the number of passes taken by that algorithm with depth-first

## A Reason for Nonreducible Flow Graphs

There is one place where we cannot generally expect a flow graph to be reducible. If we reverse the edges of a program flow graph, as we did in Algorithm 9.46 to find natural loops, then we may not get a reducible flow graph. The intuitive reason is that, while typical programs have loops with single entries, those loops sometimes have several exits, which become entries when we reverse the edges.

block ordering is actually two plus the depth. A study<sup>10</sup> has shown that typical flow graphs have an average depth around 2.75. Thus, the algorithm converges very quickly.

In the case of backward-flow problems, like live variables, we visit the nodes in the reverse of the depth-first order. Thus, we may propagate a use of a variable in block 17 backwards along the path

3 -> 5    19 -> 35    16    23 -> 45    4 -> 10    17

in one pass to IN[4], where we must wait for the next pass in order to reach OUT[45]. On the second pass it reaches IN[16], and on the third pass it goes from OUT[35] to OUT[3].

In general, one-plus-the-depth passes suffice to carry the use of a variable backward, along any acyclic path. However, we must choose the reverse of depth-first order to visit the nodes in a pass, because then, uses propagate along any decreasing sequence in a single pass.

The bound described so far is an upper bound on all problems where cyclic paths add no information to the analysis. In special problems such as dominators, the algorithm converges even faster. In the case where the input flow graph is reducible, the correct set of dominators for each node is obtained in the first iteration of a data-flow algorithm that visits the nodes in depth-first ordering. If we do not know that the input is reducible ahead of time, it takes an extra iteration to determine that convergence has occurred.

### 9.6.8 Exercises for Section 9.6

Exercise 9.6.1: For the flow graph of Fig. 9.10 (see the exercises for Section 9.1):

- i. Compute the dominator relation.
- ii. Find the immediate dominator of each node.

<sup>10</sup>D. E. Knuth, "An empirical study of FORTRAN programs," *Software — Practice and Experience* 1:2 (1971), pp. 105-133.

- Hi.* Construct the dominator tree.
- iv.* Find one depth-first ordering for the flow graph.
  - v.* Indicate the advancing, retreating, cross, and tree edges for your answer to *iv.*
- vi.* Is the flow graph reducible?
- vii.* Compute the depth of the flow graph.
- viii.* Find the natural loops of the flow graph.

**Exercise 9.6.2:** Repeat Exercise 9.6.1 on the following flow graphs:

- a) Fig. 9.3.
- b) Fig. 8.9.
- c) Your flow graph from Exercise 8.4.1.
- d) Your flow graph from Exercise 8.4.2.

**! Exercise 9.6.3:** Prove the following about the *dom* relation:

- a) If  $a \text{ dom } b$  and  $b \text{ dom } c$ , then  $a \text{ dom } c$  (*transitivity*).
- b) It is never possible that both  $a \text{ dom } b$  and  $b \text{ dom } a$  hold, if  $a \neq b$  (*anti-symmetry*).
- c) If  $a$  and  $b$  are two dominators of  $n$ , then either  $a \text{ dom } b$  or  $b \text{ dom } a$  must hold.
- d) Each node  $n$  except the entry has a unique *immediate dominator* — the dominator that appears closest to  $n$  along any acyclic path from the entry to  $n$ .

**! Exercise 9.6.4:** Figure 9.42 is one depth-first presentation of the flow graph of Fig. 9.38. How many other depth-first presentations of this flow graph are there? Remember, order of children matters in distinguishing depth-first presentations.

**!! Exercise 9.6.5:** Prove that a flow graph is reducible if and only if when we remove all the back edges (those whose heads dominate their tails), the resulting flow graph is acyclic.

**! Exercise 9.6.6:** A *complete flow graph* on  $n$  nodes has arcs  $i \rightarrow j$  between any two nodes  $i$  and  $j$  (in both directions). For what values of  $n$  is this graph reducible?

**! Exercise 9.6.7:** A *complete, acyclic flow graph* on  $n$  nodes  $1, 2, \dots, n$  has arcs  $i \rightarrow j$  for all nodes  $i$  and  $j$  such that  $i < j$ . Node 1 is the entry.

- a) For what values of  $n$  is this graph reducible?
- b) Does your answer to (a) change if you add self-loops  $i \rightarrow i$  for all nodes  $i$ ?

**! Exercise 9.6.8:** The natural loop of a back edge  $n \rightarrow h$  was defined to be  $h$  plus the set of nodes that can reach  $n$  without going through  $h$ . Show that  $h$  dominates all the nodes in the natural loop of  $n \rightarrow h$ .

**!! Exercise 9.6.9:** We claimed that the flow graph of Fig. 9.45 is nonreducible. If the arcs were replaced by paths of disjoint nodes (except for the endpoints, of course), then the flow graph would still be nonreducible. In fact, node **1** need not be the entry; it can be any node reachable from the entry along a path whose intermediate nodes are not part of any of the four explicitly shown paths. Prove the converse: that every nonreducible flow graph has a subgraph like Fig. 9.45, but with arcs possibly replaced by node-disjoint paths and node **1** being any node reachable from the entry by a path that is node-disjoint from the four other paths.

**! Exercise 9.6.10:** Show that every depth-first presentation for every nonreducible flow graph has a retreating edge that is not a back edge.

**!! Exercise 9.6.11:** Show that if the following condition

$$f(a) \wedge g(a) \wedge a \leq f(g(a))$$

holds for all functions  $f$  and  $g$ , and value  $a$ , then the general iterative algorithm, Algorithm 9.25, with iteration following a depth-first ordering, converges within 2-plus-the-depth passes.

**! Exercise 9.6.12:** Find a nonreducible flow graph with two different DFST's that have different depths.

**! Exercise 9.6.13:** Prove the following:

- a) If a definition  $d$  is in  $\mathbf{IN}[B]$ , then there is some acyclic path from the block containing  $d$  to  $B$  such that  $d$  is in the  $\mathbf{IN}$ 's and  $\mathbf{OUT}$ 's all along that path.
- b) If an expression  $x + y$  is *not* available at the entrance to block  $B$ , then there is some acyclic path that demonstrates that fact; either the path is from the entry node and includes no statement that kills or generates  $x + y$ , or the path is from a block that kills  $x + y$  and along the path there is no subsequent generation of  $x + y$ .
- c) If  $x$  is live on exit from block  $B$ , then there is an acyclic path from  $B$  to a use of  $x$ , along which there are no definitions of  $x$ .

## 9.7 Region-Based Analysis

The iterative data-flow analysis algorithm we have discussed so far is just one approach to solving data-flow problems. Here we discuss another approach called *region-based analysis*. Recall that in the iterative-analysis approach, we create transfer functions for basic blocks, then find the fixedpoint solution by repeated passes over the blocks. Instead of creating transfer functions just for individual blocks, a region-based analysis finds transfer functions that summarize the execution of progressively larger regions of the program. Ultimately, transfer functions for entire procedures are constructed and then applied, to get the desired data-flow values directly.

While a data-flow framework using an iterative algorithm is specified by a semilattice of data-flow values and a family of transfer functions closed under composition, region-based analysis requires more elements. A region-based framework includes both a semilattice of data-flow values and a semilattice of transfer functions that must possess a meet operator, a composition operator, and a closure operator. We shall see what all these elements entail in Section 9.7.4.

A region-based analysis is particularly useful for data-flow problems where paths that have cycles may change the data-flow values. The closure operator allows the effect of a loop to be summarized more effectively than does iterative analysis. The technique is also useful for interprocedural analysis, where transfer functions associated with a procedure call may be treated like the transfer functions associated with basic blocks.

For simplicity, we shall consider only forward data-flow problems in this section. We first illustrate how region-based analysis works by using the familiar example of reaching definitions. In Section 9.8 we show a more compelling use of this technique, when we study the analysis of induction variables.

### 9.7.1 Regions

In region-based analysis, a program is viewed as a hierarchy of *regions*, which are (roughly) portions of a flow graph that have only one point of entry. We should find this concept of viewing code as a hierarchy of regions intuitive, because a block-structured procedure is naturally organized as a hierarchy of regions. Each statement in a block-structured program is a region, as control flow can only enter at the beginning of a statement. Each level of statement nesting corresponds to a level in the region hierarchy.

Formally, a *region* of a flow graph is a collection of nodes  $N$  and edges  $E$  such that

1. There is a header  $h$  in  $N$  that dominates all the nodes in  $N$ .
2. If some node  $m$  can reach a node  $n$  in  $N$  without going through  $h$ , then  $m$  is also in  $N$ .

3.  $E$  is the set of all the control flow edges between nodes  $n_i$  and  $n_j$  in  $N$ , except (possibly) for some that enter  $h$ .

Example 9.50: Clearly a natural loop is a region, but a region does not necessarily have a back edge and need not contain any cycles. For example, in Fig. 9.47, nodes  $B_1$  and  $B_2$ , together with the edge  $B_1 \rightarrow B_2$  form a region; so do nodes  $B_1, B_2$ , and  $B_3$  with edges  $B_1 \rightarrow B_2$ ,  $B_2 \rightarrow B_3$ , and  $B_3 \rightarrow B_1$ .

However, the subgraph with nodes  $B_2$  and  $B_3$  with edge  $B_2 \rightarrow B_3$  does not form a region, because control may enter the subgraph at both nodes  $B_2$  and  $B_3$ . More precisely, neither  $B_2$  nor  $B_3$  dominates the other, so condition (1) for a region is violated. Even if we picked, say,  $B_2$  to be the "header," we would violate condition (2), since we can reach  $B_3$  from  $B_1$  without going through  $B_2$ , and  $B_3$  is not in the "region." •

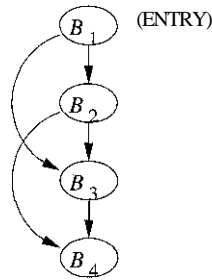

Figure 9.47: Examples of regions

## 9.7.2 Region Hierarchies for Reducible Flow Graphs

In what follows, we shall assume the flow graph is reducible. If occasionally we must deal with nonreducible flow graphs, then we can use a technique called "node splitting" that will be discussed in Section 9.7.6.

To construct a hierarchy of regions, we identify the natural loops. Recall from Section 9.6.6 that in a reducible flow graph, any two natural loops are either disjoint or one is nested within the other. The process of "parsing" a reducible flow graph into its hierarchy of loops begins with every block as a region by itself. We call these regions *leaf regions*. Then, we order the natural loops from the inside out, i.e., starting with the innermost loops. To process a loop, we replace the entire loop by a node in two steps:

1. First, the *body* of the loop  $L$  (all nodes and edges except the back edges to the header) is replaced by a node representing a region  $R$ . Edges to the header of  $L$  now enter the node for  $R$ . An edge from any exit of loop  $L$  is replaced by an edge from  $R$  to the same destination. However, if the edge is a back edge, then it becomes a loop on  $R$ . We call  $R$  a *body region*.



2. Next, we construct a region  $R'$  that represents the entire natural loop  $L$ . We call  $R'$  a *loop region*. The only difference between  $R$  and  $R'$  is that the latter includes the back edges to the header of loop  $L$ . Put another way, when  $R'$  replaces  $R$  in the flow graph, all we have to do is remove the edge from  $R$  to itself.

We proceed this way, reducing larger and larger loops to single nodes, first with a looping edge and then without. Since loops of a reducible flow graph are nested or disjoint, the loop region's node can represent all the nodes of the natural loop in the series of flow graphs that are constructed by this reduction process.

Eventually, all natural loops are reduced to single nodes. At that point, the flow graph may be reduced to a single node, or there may be several nodes remaining, with no loops; i.e., the reduced flow graph is an acyclic graph of more than one node. In the former case we are done constructing the region hierarchy, while in the latter case, we construct one more body region for the entire flow graph.

Example 9.51: Consider the control flow graph in Fig. 9.48(a). There is one back edge in this flow graph, which leads from  $B_1$  to  $B_2$ . The hierarchy of regions is shown in Fig. 9.48(b); the edges shown are the edges in the region flow graphs. There are altogether 8 regions:

1. Regions  $R_1, \dots, R_8$  are leaf regions representing blocks  $B_1$  through  $B_8$ , respectively. Every block is also an exit block in its region.
2. Body region  $R_Q$  represents the body of the only loop in the flow graph; it consists of regions  $R_2, R_3$ , and  $R_4$  and three interregion edges:  $B_1 \rightarrow B_2$ ,  $B_2 \rightarrow B_3$ , and  $B_3 \rightarrow B_4$ . It has two exit blocks,  $B_1$  and  $B_4$ , since they both have outgoing edges not contained in the region. Figure 9.49(a) shows the flow graph with  $R_Q$  reduced to a single node. Notice that although the edges  $R_2 \rightarrow R_3$  and  $R_3 \rightarrow R_4$  have both been replaced by edge  $R_Q \rightarrow R_4$ , it is important to remember that the latter edge represents the two former edges, since we shall have to propagate transfer functions across this edge eventually, and we need to know that what comes out of both blocks  $B_2$  and  $B_3$  will reach the header of  $R_Q$ .
3. Loop region  $R_L$  represents the entire natural loop. It includes one subregion,  $R_Q$ , and one back edge  $B_1 \rightarrow B_2$ . It has also two exit nodes, again  $B_1$  and  $B_4$ . Figure 9.49(b) shows the flow graph after the entire natural loop is reduced to  $R_L$ .
4. Finally, body region  $R_B$  is the top region. It includes three regions,  $R_1$ ,  $R_L$ , and  $R_8$ , and three interregion edges,  $B_1 \rightarrow B_2$ ,  $B_2 \rightarrow B_3$ , and  $B_4 \rightarrow B_8$ . When we reduce the flow graph to  $R_B$ , it becomes a single node. Since there are no back edges to its header,  $B_1$ , there is no need for a final step reducing this body region to a loop region.

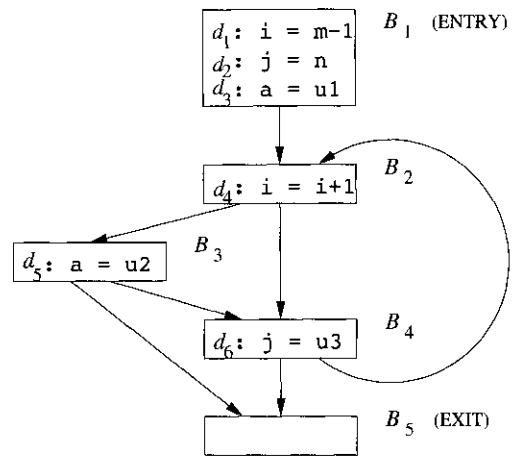

(a)

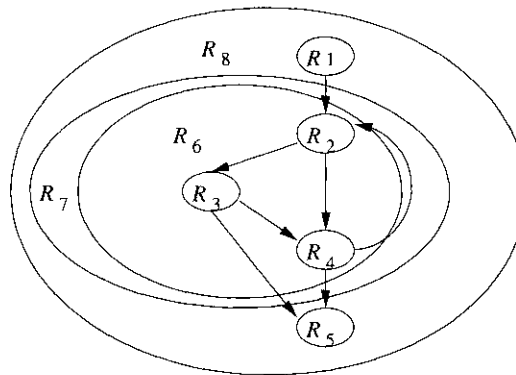

(b)

Figure 9.48: (a) An example flow graph for the reaching definitions problem and (b) Its region hierarchy

•

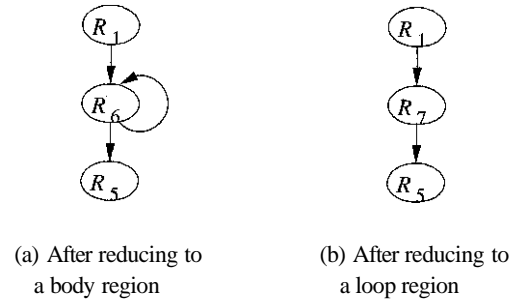

Figure 9.49: Steps in the reduction of the flow graph of Fig. 9.47 to a single region

To summarize the process of decomposing reducible flow graphs hierarchically, we offer the following algorithm.

**Algorithm 9.52:** Constructing a bottom-up order of regions of a reducible flow graph.

**INPUT:** A reducible flow graph  $G$ .

**OUTPUT:** A list of regions of  $G$  that can be used in region-based data-flow problems.

**METHOD:**

1. Begin the list with all the leaf regions consisting of single blocks of  $G$ , in any order.
2. Repeatedly choose a natural loop  $L$  such that if there are any natural loops contained within  $L$ , then these loops have had their body and loop regions added to the list already. Add first the region consisting of the body of  $L$  (i.e.,  $L$  without the back edges to the header of  $L$ ), and then the loop region of  $L$ .
3. If the entire flow graph is not itself a natural loop, add at the end of the list the region consisting of the entire flow graph.

•

### 9.7.3 Overview of a Region-Based Analysis

For each region  $R$ , and for each subregion  $R'$  within  $R$ , we compute a transfer function  $[R']$  that summarizes the effect of executing all possible paths

## Where "Reducible" Comes From

We now see why reducible flow graphs were given that name. While we shall not prove this fact, the definition of "reducible flow graph" used in this book, involving the back edges of the graph, is equivalent to several definitions in which we mechanically reduce the flow graph to a single node. The process of collapsing natural loops described in Section 9.7.2 is one of them. Another interesting definition is that the reducible flow graphs are all and only those graphs that can be reduced to a single node by the following two transformations:

$T_1$ : Remove an edge from a node to itself.

$T_2$ : If node  $n$  has a single predecessor  $m$ , and  $n$  is not the entry of the flow graph, combine  $m$  and  $n$ .

leading from the entry of  $R$  to the entry of  $R'$ , while staying within  $R$ . We say that a block  $B$  within  $R$  is an *exit block* of region  $R$  if it has an outgoing edge to some block outside  $R$ . We also compute a transfer function for each exit block  $B$  of  $R$ , denoted  $f_{OUT}[B]$  that summarizes the effect of executing all possible paths within  $R$ , leading from the entry of  $R$  to the exit of  $B$ .

We then proceed up the region hierarchy, computing transfer functions for progressively larger regions. We begin with regions that are single blocks, where  $f_{IN}[B]$  is just the identity function and  $f_{OUT}[B]$  is the transfer function for the block  $B$  itself. As we move up the hierarchy,

- If  $R$  is a body region, then the edges belonging to  $R$  form an acyclic graph on the subregions of  $R$ . We may proceed to compute the transfer functions in a topological order of the subregions.
- If  $R$  is a loop region, then we only need to account for the effect of the back edges to the header of  $R$ .

Eventually, we reach the top of the hierarchy and compute the transfer functions for region  $R$ , that is the entire flow graph. How we perform each of these computations will be seen in Algorithm 9.53.

The next step is to compute the data-flow values at the entry and exit of each block. We process the regions in the reverse order, starting with region  $R_n$  and working our way down the hierarchy. For each region, we compute the data-flow values at the entry. For region  $R_n$ , we apply  $f_{IN}[R_n](IN[ENTRY])$  to get the data-flow values at the entry of the subregions  $R$  in  $R_n$ . We repeat until we reach the basic blocks at the leaves of the region hierarchy.

### 9.7.4 Necessary Assumptions About Transfer Functions

In order for region-based analysis to work, we need to make certain assumptions about properties of the set of transfer functions in the framework. Specifically, we need three primitive operations on transfer functions: composition, meet and closure; only the first is required for data-flow frameworks that use the iterative algorithm.

#### Composition

The transfer function of a sequence of nodes can be derived by composing the functions representing the individual nodes. Let  $f_1$  and  $f_2$  be transfer functions of nodes  $n_1$  and  $n_2$ . The effect of executing  $n_1$  followed by  $n_2$  is represented by  $f_2 \circ f_1$ . Function composition has been discussed in Section 9.2.2, and an example using reaching definitions was shown in Section 9.2.4. To review, let  $gen_i$  and  $kill_i$  be the *gen* and *kill* sets for  $f_i$ . Then:

$$\begin{aligned} f_2 \circ f_1(x) &= gen_2 \cup \left( (gen_1 \cup (x - kill_1)) - kill_2 \right) \\ &= (gen_2 \cup (gen_1 - kill_2)) \cup (x - (kill_1 \cup kill_2)) \end{aligned}$$

Thus, the *gen* and *kill* sets for  $f_2 \circ f_1$  are  $gen_2 \cup (gen_1 - kill_2)$  and  $kill_1 \cup kill_2$ , respectively. The same idea works for any transfer function of the gen-kill form. Other transfer functions may also be closed, but we have to consider each case separately.

#### Meet

Here, the transfer functions themselves are values of a semilattice with a meet operator  $\wedge$ . The meet of two transfer functions  $f_1$  and  $f_2$ ,  $f_1 \wedge f_2$ , is defined by  $(f_1 \wedge f_2)(x) = f_1(x) \wedge f_2(x)$ , where  $\wedge$  is the meet operator for data-flow values. The meet operator on transfer functions is used to combine the effect of alternative paths of execution with the same end points. Where it is not ambiguous, from now on, we shall refer to the meet operator of transfer functions also as  $\wedge$ . For the reaching-definitions framework, we have

$$\begin{aligned} (f_1 \wedge f_2)(x) &= (gen_1 \cup (x - kill_1)) \wedge (gen_2 \cup (x - kill_2)) \\ &= (gen_1 \cup gen_2) \cup (x - (kill_1 \vee kill_2)) \end{aligned}$$

That is, the *gen* and *kill* sets for  $f_1 \wedge f_2$  are  $gen_1 \cup gen_2$  and  $kill_1 \vee kill_2$ , respectively. Again, the same argument applies to any set of gen-kill transfer functions.

**Closure**

If  $f$  represents the transfer function of a cycle, then  $f^n$  represents the effect of going around the cycle  $n$  times. In the case where the number of iterations is not known, we have to assume that the loop may be executed 0 or more times. We represent the transfer function of such a loop by  $f^*$ , the *closure* of  $f$ , which is defined by

$$f^* = \bigcup_{n \geq 0} f^n$$

Note that  $f^0$  must be the identity transfer function, since it represents the effect of going zero times around the loop, i.e., starting at the entry and not moving. If we let  $f$  represent the identity transfer function, then we can write

$$f^* = \bigcup_{n \geq 0} f^n$$

Suppose the transfer function  $f$  in a reaching definitions framework has a *gen* set and a *kill* set. Then,

$$\begin{aligned} f(x) &= f(f(x)) \\ &= (gen \cup ((gen \cup (x - kill)) - kill)) \\ &= gen \cup (x - kill) \\ f(x) &= f(f(x)) \\ &= gen \cup (x - kill) \end{aligned}$$

and so on: any  $f^n(x)$  is  $gen \cup (x - kill)$ . That is, going around a loop doesn't affect the transfer function, if it is of the *gen-kill* form. Thus,

$$\begin{aligned} r(x) &= f^*(x) \\ &= x \cup (gen \cup (x - kill)) \\ &= gen \cup x \end{aligned}$$

That is, the *gen* and *kill* sets for  $f^*$  are *gen* and 0, respectively. Intuitively, since we might not go around a loop at all, anything in  $x$  will reach the entry to the loop. In all subsequent iterations, the reaching definitions include those in the *gen* set.

### 9.7.5 An Algorithm for Region-Based Analysis

The following algorithm solves a forward data-flow-analysis problem on a reducible flow graph, according to some framework that satisfies the assumptions of Section 9.7.4. Recall that  $f_{R,N}$  and  $f_{R,B}$  are transfer functions that transform data-flow values at the entry to region  $R$  into the correct value at the entry of subregion  $R'$  and the exit of the exit block  $B$ , respectively.

Algorithm 9.53: Region-based analysis.

**INPUT:** A data-flow framework with the properties outlined in Section 9.7.4 and a reducible flow graph  $G$ .

**OUTPUT:** Data-flow values  $m[B]$  for each block  $B$  of  $G$ .

**METHOD:**

1. Use Algorithm 9.52 to construct the bottom-up sequence of regions of  $G$ , say  $R_1, R_2, \dots, R_n$ , where  $R_n$  is the topmost region.
2. Perform the bottom-up analysis to compute the transfer functions summarizing the effect of executing a region. For each region  $R_i, R_{i+1}, \dots, R_n$ , in the bottom-up order, do the following:
  - (a) If  $R$  is a leaf region corresponding to block  $B$ , let  $f_{R,N} = f_{R,B}$  and  $f_{R,B} = f_{B,B}$ , the transfer function associated with block  $B$ .
  - (b) If  $R$  is a body region, perform the computation of Fig. 9.50(a).
  - (c) If  $R$  is a loop region, perform the computation of Fig. 9.50(b).
3. Perform the top-down pass to find the data-flow values at the beginning of each region.
  - (a)  $m[R_1] = \text{IN}[\text{ENTRY}]$ .
  - (b) For each region  $R$  in  $\{R_1, \dots, R_{n-1}\}$ , in the top-down order, compute  $m[R] = f_{R,N}(m[R'])$ , where  $R'$  is the immediate enclosing region of  $R$ .

Let us first look at the details of how the bottom-up analysis works. In line (1) of Fig. 9.50(a) we visit the subregions of a body region, in some topological order. Line (2) computes the transfer function representing all the possible paths from the header of  $R$  to the header of  $S$ ; then in lines (3) and (4) we compute the transfer functions representing all the possible paths from the header of  $R$  to the exits of  $R$  — that is, to the exits of all blocks that have successors outside  $S$ . Notice that all the predecessors  $B'$  in  $R$  must be in regions that precede  $S$  in the topological order constructed at line (1). Thus,  $f_{B',B}$  will have been computed already, in line (4) of a previous iteration through the outer loop.

For loop regions, we perform the steps of lines (1) through (4) in Fig. 9.50(b). Line (2) computes the effect of going around the loop body region  $S$  zero or more times. Lines (3) and (4) compute the effect at the exits of the loop after one or more iterations.

In the top-down pass of the algorithm, step 3(a) first assigns the boundary condition to the input of the top-most region. Then if  $R$  is immediately contained in  $R'$ , we can simply apply the transfer function  $f_{R'}[IN[JR]]$  to the data-flow value  $w[R']$  to compute  $m[R]$ . •

- 1) **for** (each subregion  $S$  immediately contained in  $R$ , in topological order) {
- 2)  $f_{R,W[S]} = \text{Apredecessors } B \text{ in } R \text{ of the header of } S \text{ /fl.OUTps]} \text{ } 5$   
/\* if  $S$  is the header of region  $R$ , then  $f_{R,JN[S]}$  is the meet over nothing, which is the identity function \*/
- 3) **for** (each exit block  $B$  in  $S$ )
- 4)  $f_{R,OUT[B]} = f_{S,OUT[B]} \circ f_{R,IN[S]}$ ;
- }

(a) Constructing transfer functions for a body region  $R$

- 1) let  $S$  be the body region immediately nested within  $R$  that is,  $S$  is  $R$  without back edges from  $R$  to the header of  $R$ ;
- 2)  $f_{R,W[S]} = (\text{Apredecessors } B \text{ in } R \text{ of the header of } S \text{ /s,OUTp3]) \text{ } 5$
- 3) **for** (each exit block  $B$  in  $R$ )
- 4)  $f_{R,OUT[B]} = f_{S,OUTp3]} \circ f_{R,IN[S]}$ ;

(b) Constructing transfer functions for a loop region  $R'$

Figure 9.50: Details of region-based data-flow computations

Example 9.54 : Let us apply Algorithm 9.53 to find reaching definitions in the flow graph in Fig. 9.48(a). Step 1 constructs the bottom-up order in which the regions are visited; this order will be the numerical order of their subscripts,  $R_1, R_2, \dots, R_n$ .

The values of the *gen* and *kill* sets for the five blocks are summarized below:

$B$	$B_1$	$B_2$	$B_3$	$B_4$	$B_5$
<i>gen</i> <sub><math>B</math></sub>	$\{d_1, d_2, d_3\}$			$W$	$0$
<i>kills</i>	$\{d_1, d_2, d_3\}$	$\{d_1\}$		$\{d_2\}$	$0$

Remember the simplified rules for *gen-kill* transfer functions, from Section 9.7.4:



- To take the meet of transfer functions, take the union of the pen's and the intersection of the *kiWs*.
- To compose transfer functions, take the union of both the pen's and the *kill*'s. However, as an exception, an expression that is generated by the first function, not generated by the second, but killed by the second is *not* in the *gen* of the result.
- To take the closure of a transfer function, retain its *gen* and replace the *kill* by **0**.

The first five regions  $R_1, \dots, R_5$  are blocks  $B_1, \dots, B_5$ , respectively. For  $1 < i < 5$ ,  $f_{i,IN[B_i]}$  is the identity function, and  $f_{j,OUT[B_i]}$  is the transfer function for block  $B_i$ :

$$f_{B_i,OUT[B_i]}(x) = \{x - kill\} \cup gen.$$

	Transfer Function	<i>gen</i>	<i>kill</i>
<i>Re</i>	$f_{i,IN[B_i]} = I$ $f_{i,OUT[B_i]} = f_{i,OUT[B_i]} \circ f_{K_i,IN[K_i]}$ $f_{Re,INLRs} = f_{i,OUT[B_i]}$ $f_{i,OUT[B_i]} = f_{i,OUT[B_i]} \circ f_{R_i,IN[R_i]}$ $f_{j,IN[i?]} = f_{i,OUT[B_i]} \circ f_{i,OUT[B_i]}$ $f_{ft,OUTp3} = f_{i,OUT[B_i]} \circ f_{i,IN[R_i]}$	<b>0</b> $\{d_i\}$ $\{ci_i\}$ $\{^4, ^5\}$ $\{d_i, d_i\}$ $\{dA, d5, dQ\}$	<b>0</b> $\{di\}$ $\{di\}$ $\{di, dz\}$ $\{di\}$
<i>Rr</i>	$f_{R_i,IN[R_i]} = f_{R_i,OUT[B_i]}$ $f_{i,OUT[B_i]} = f_{j,OUT[B_i]} \circ f_{R_i,IN[R_i]}$ $f_{K_i,OUT[B_i]} = f_{i,OUT[B_i]} \circ f_{i,IN[B_i]}$	$\{d4, d5, de\}$ $\{d4, dn, d6\}$ $\{d_i, rf5, de\}$	<b>0</b> $\{rfi, rf_i\}$ $\{(2i, d)\}$
<i>Rs</i>	$f_{i,IN[i]} = I$ $f_{i,OUTp3} = f_{i,OUT[B_i]}$ $f_{i,IN[K_i]} = f_{B_i,OUT[B_i]}$ $f_{i,OUT[B_i]} = f_{B_i,OUT[B_i]} \circ f_{K_i,IN[J?]}$ $f_{i,OUT[B_i]} = f_{R_i,OUT[B_i]} \circ f_{H_i,IN[R_i]}$ $f_{H_i,IN[B_i]} = f_{i,OUT[B_i]} \circ f_{i,OUT[B_i]}$ $f_{i,OUT[B_i]} = f_{i,OUT[B_i]} \circ f_{R_i,INp3}$	<b>0</b> $\{dx, d2, da\}$ $\{di, d2, ds\}$ $\{d2, d4, d5, ds\}$ $\{d3, d4, d5, d_j\}$ $\{d2, dz, d4, d5, d_6\}$ $\{(^2, ^3, ^4, ^5, ^6)\}$	<b>0</b> $\{d4, d5, d\&\}$ $\{d4, d5, d\&\}$ $\{di, ds\}$ $\{di, d_j\}$ $\{di\}$ $\{di\}$

Figure 9.51: Computing transfer functions for the flow graph in Fig. 9.48(a), using region-based analysis

The rest of the transfer functions constructed in Step 2 of Algorithm 9.50 are summarized in Fig. 9.51. Region *Re*, consisting of regions *R<sub>1</sub>*, *R<sub>3</sub>*, and *R<sub>5</sub>*,

represents the loop body and thus does not include the back edge  $B_i \rightarrow B_j$ . The order of processing these regions will be the only topological order:  $R_1, R_2, R_3$ . First,  $R_1$  has no predecessors within  $R_1$ ; remember that the edge  $B_i \rightarrow B_j$  goes outside  $R_1$ . Thus,  $f_{R_1, IN}[B_i]$  is the identity function,<sup>11</sup> and  $f_{R_1, OUT}[B_j]$  is the transfer function for block  $B_j$  itself.

The header of region  $B_i$  has one predecessor within  $R_1$ , namely  $R_1$ . The transfer function to its entry is simply the transfer function to the exit of  $B_j$ ,  $f_{R_1, OUT}[B_j]$  which has already been computed. We compose this function with the transfer function of  $B_i$  within its own region to compute the transfer function to the exit of  $B_i$ .

Last, for the transfer function to the entry of  $R_2$ , we must compute

$$f_{R_2, IN}[B_i] \wedge f_{R_1, OUT}[B_j]$$

because both  $B_i$  and  $B_j$  are predecessors of  $B_i$ , the header of  $R_2$ . This transfer function is composed with the transfer function  $f_{R_2, IN}[B_i]$  to get the desired function  $f_{R_2, IN}[B_i]$ . Notice, for example, that  $d_i$  is not killed in this transfer function, because the path  $B_i \rightarrow B_j$  does not redefine variable  $a$ .

Now, consider loop region  $R_2$ . It contains only one subregion  $RQ$  which represents its loop body. Since there is only one back edge,  $B_i \rightarrow B_j$ , to the header of  $RQ$ , the transfer function representing the execution of the loop body 0 or more times is just  $f_{RQ, IN}[B_i]$  and the kill set is 0. There are two exits out of region  $R_2$ , blocks  $B_i$  and  $B_j$ . Thus, this transfer function is composed with each of the transfer functions of  $RQ$  to get the corresponding transfer functions of  $R_2$ . Notice, for instance, how  $d_i$  is in the gen set for  $f_{R_2, IN}[B_i]$  because of paths like  $B_i \rightarrow B_j \rightarrow B_i \rightarrow B_j$ , or even  $B_i \rightarrow B_j \rightarrow B_i \rightarrow B_j$ .

Finally, consider  $R_3$ , the entire flow graph. Its subregions are  $R_1$ ,  $R_2$ , and  $R_3$ , which we shall consider in that topological order. As before, the transfer function  $f_{R_3, IN}[B_i]$  is simply the identity function, and the transfer function  $f_{R_3, OUT}[B_j]$  is  $f_{R_3, OUT}[B_j]$  in turn is  $f_{R_3, OUT}[B_j]$ .

The header of  $R_3$ , which is  $B_i$ , has only one predecessor,  $B_i$ , so the transfer function to its entry is simply the transfer function out of  $B_i$  in region  $R_3$ . We compose  $f_{R_3, IN}[B_i]$  with the transfer functions to the exits of  $B_i$  and  $B_j$  within  $R_3$  to obtain their corresponding transfer functions within  $R_3$ . Lastly, we consider  $R_3$ . Its header,  $B_i$ , has two predecessors within  $R_3$ , namely  $B_i$  and  $B_j$ . Therefore, we compute  $f_{R_3, IN}[B_i] \wedge f_{R_3, OUT}[B_j]$  to get  $f_{R_3, IN}[B_i]$ . The transfer function of block  $B_i$  is the identity function,  $f_{R_3, OUT}[B_j] = f_{R_3, IN}[B_j]$ .

Step 3 computes the actual reaching definitions from the transfer functions. In step 3(a),  $m[R_1] = 0$  since there are no reaching definitions at the beginning of the program. Figure 9.52 shows how step 3(b) computes the rest of the data-flow values. The step starts with the subregions of  $R_1$ . Since the transfer function from the start of  $R_1$  to the start of each of its subregion has been

<sup>11</sup>Strictly speaking, we mean  $f_{R_1, IN}[B_i]$ . If a region like  $R_1$  is a single block, it is often clearer if we use the block name rather than the region name in this context.

computed, a single application of the transfer function finds the data-flow value at the start each subregion. We repeat the steps until we get the data-flow values of the leaf regions, which are simply the individual basic blocks. Note that the data-flow values shown in Figure 9.52 are exactly what we would get had we applied iterative data-flow analysis to the same flow graph, as must be the case, of course. •

$$\begin{array}{l}
 \text{INpRg]} = 0 \\
 \text{--- /R}_s\text{IN[iEi]} \left( \begin{array}{l} m[R_i] = 0 \\ m[R_i] = \{d_1, d_2, d_3\} \\ m[R_i] = \{d_2, d_3, d_4\} \\ m[R_i] = \{d_1, d_2, d_3, d_4, d_5, d_6\} \\ \text{IN}[R_i] = \{d_2, d_3, d_4\} \\ m[R_i] = \{d_2, d_3, d_4\} \\ \text{IN}[R_i] = \{d_1, d_2, d_3, d_4, d_5, d_6\} \end{array} \right)
 \end{array}$$

Figure 9.52: Final steps of region-based flow analysis

### 9.7.6 Handling Nonreducible Flow Graphs

If nonreducible flow graphs are expected to be common for the programs to be processed by a compiler or other program-processing software, then we recommend using an iterative rather than a hierarchy-based approach to data-flow analysis. However, if we need only to be prepared for the occasional nonreducible flow graph, then the following "node-splitting" technique is adequate.

Construct regions from natural loops to the extent possible. If the flow graph is nonreducible, we shall find that the resulting graph of regions has cycles, but no back edges, so we cannot parse the graph any further. A typical situation is suggested in Fig. 9.53(a), which has the same structure as the nonreducible flow graph of Fig. 9.45, but the nodes in Fig. 9.53 may actually be complex regions, as suggested by the smaller nodes within.

We pick some region  $R$  that has more than one predecessor and is not the header of the entire flow graph. If  $i?$  has  $k$  predecessors, make  $k$  copies of the entire flow graph  $R$ , and connect each predecessor of  $i?$ 's header to a different copy of  $R$ . Remember that only the header of a region could possibly have a predecessor outside that region. It turns out, although we shall not prove it, that such node splitting results in a reduction by at least one in the number of regions, after new back edges are identified and their regions constructed. The resulting graph may still not be reducible, but by alternating a splitting phase with a phase where new natural loops are identified and collapsed to regions, we eventually are left with a single region; i.e., the flow graph has been reduced.

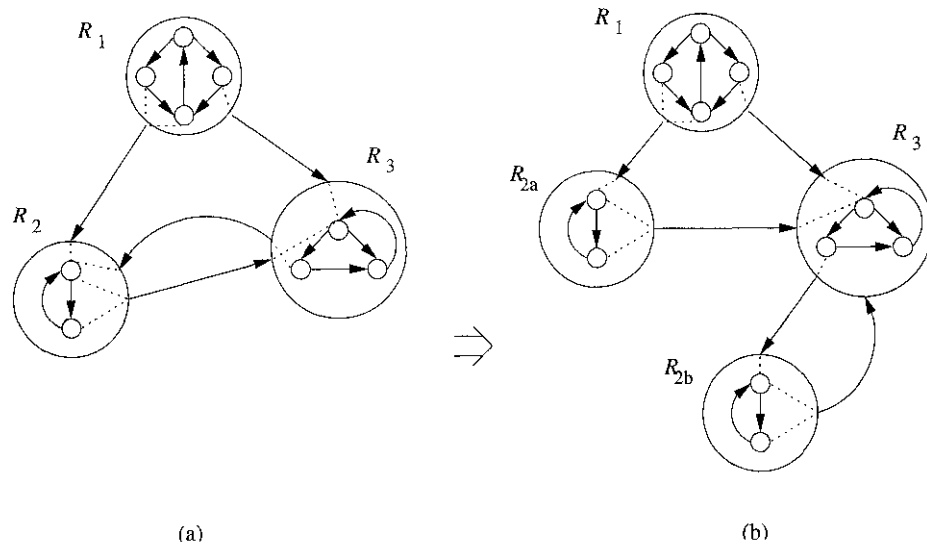

Figure 9.53: Duplicating a region to make a nonreducible flow graph become reducible

Example 9.55: The splitting shown in Fig. 9.53(b) has turned the edge  $R_3 \rightarrow R_2$  into a back edge, since  $R_3$  now dominates  $R_2$ . These two regions may thus be combined into one. The resulting three regions —  $R_1$ ,  $R_2$ , and the new region — form an acyclic graph, and therefore may be combined into a single body region. We thus have reduced the entire flow graph to a single region. In general, additional splits may be necessary, and in the worst case, the total number of basic blocks could become exponential in the number of blocks in the original flow graph. •

We must also think about how the result of the data-flow analysis on the split flow graph relates to the answer we desire for the original flow graph. There are two approaches we might consider.

1. Splitting regions may be beneficial for the optimization process, and we can simply revise the flow graph to have copies of certain blocks. Since each duplicated block is entered along only a subset of the paths that reached the original, the data-flow values at these duplicated blocks will tend to contain more specific information than was available at the original. For instance, fewer definitions may reach each of the duplicated blocks that reach the original block.
2. If we wish to retain the original flow graph, with no splitting, then after analyzing the split flow graph, we look at each split block  $B$ , and its corresponding set of blocks  $B_1, B_2, \dots, B_n$ . We may compute  $m[B]$  —  $m[B_1] \wedge \text{IN}[B_2] \wedge \dots \wedge \text{IN}[B_n]$ , and similarly for the OUT's.

### 9.7.7 Exercises for Section 9.7

**Exercise 9.7.1:** For the flow graph of Fig. 9.10 (see the exercises for Section 9.1):

- i.* Find all the possible regions. You may, however, omit from the list the regions consisting of a single node and no edges.
- ii.* Give the set of nested regions constructed by Algorithm 9.52.
- Hi.* Give a  $T_1$ - $T_2$  reduction of the flow graph as described in the box on "Where 'Reducible' Comes From" in Section 9.7.2.

**Exercise 9.7.2:** Repeat Exercise 9.7.1 on the following flow graphs:

- a) Fig. 9.3.
- b) Fig. 8.9.
- c) Your flow graph from Exercise 8.4.1.
- d) Your flow graph from Exercise 8.4.2.

**Exercise 9.7.3:** Prove that every natural loop is a region.

**!! Exercise 9.7.4:** Show that a flow graph is reducible if and only it can be transformed to a single node using:

- a) The operations  $T_1$  and  $T_2$  described in the box in Section 9.7.2.
- b) The region definition introduced in Section 9.7.2.

**! Exercise 9.7.5:** Show that when you apply node splitting to a nonreducible flow graph, and then perform  $T_1$ - $T_2$  reduction on the resulting split graph, you wind up with strictly fewer nodes than you started with.

**! Exercise 9.7.6:** What happens if you apply node-splitting and  $T_1$ - $T_2$  reduction alternately, to reduce a complete directed graph of  $n$  nodes?

## 9.8 Symbolic Analysis

We shall use symbolic analysis in this section to illustrate the use of region-based analysis. In this analysis, we track the values of variables in programs symbolically as expressions of input variables and other variables, which we call *reference variables*. Expressing variables in terms of the same set of reference variables draws out their relationships. Symbolic analysis can be used for a range of purposes such as optimization, parallelization, and analyses for program understanding.

```

1) x = input();
2) y = x - 1;
3) z = y - 1;
4) A[x] = 10;
5) ACy = 11;
6) if (z > x)
7)     z = x;

```

Figure 9.54: An example program motivating symbolic analysis

Example 9.56: Consider the simple example program in Fig. 9.54. Here, we use  $x$  as the sole reference variable. Symbolic analysis will find that  $y$  has the value  $x - 1$  and  $z$  has the value  $x - 2$  after their respective assignment statements in lines (2) and (3). This information is useful, for example, in determining that the two assignments in lines (4) and (5) write to different memory locations and can thus be executed in parallel. Furthermore, we can tell that the condition  $z > x$  is never true, thus allowing the optimizer to remove the conditional statement in lines (6) and (7) all together. •

### 9.8.1 Affine Expressions of Reference Variables

Since we cannot create succinct and closed-form symbolic expressions for all values computed, we choose an abstract domain and approximate the computations with the most precise expressions within the domain. We have already seen an example of this strategy before: constant propagation. In constant propagation, our abstract domain consists of the constants, an UNDEF symbol if we have not yet determined if the value is a constant, and a special NAC symbol that is used whenever a variable is found not to be a constant.

The symbolic analysis we present here expresses values as *affine* expressions of reference variables whenever possible. An expression is affine with respect to variables  $v_1, \dots, v_n$  if it can be expressed as  $C_0 + c_1v_1 + \dots + c_nv_n$ , where  $C_0, \dots, c_n$  are constants. Such expressions are informally known as linear expressions. Strictly speaking, an affine expression is linear only if  $CQ$  is zero. We are interested in affine expressions because they are often used to index arrays in loops—such information is useful for optimizations and parallelization. Much more will be said about this topic in Chapter 11.

#### Induction Variables

Instead of using program variables as reference variables, an affine expression can also be written in terms of the count of iterations through the loop. Variables whose values can be expressed as  $c_i i + c_0$ , where  $i$  is the count of iterations through the closest enclosing loop, are known as *induction variables*.

Example 9.57: Consider the code fragment

```

for (m = 10; m < 20; m++)
    { x = m*3; A[x] = 0; }

```

Suppose we introduce for the loop a variable, say  $i$ , representing the number of iterations executed. The value  $i$  is 0 in the first iteration of the loop, 1 in the second, and so on. We can express variable  $m$  as an affine expression of  $i$ , namely  $m = i + 10$ . Variable  $x$ , which is  $3m$ , takes on values 30, 33, ..., 57 during successive iterations of the loop. Thus,  $x$  has the affine expression  $x = 30 + 3i$ . We conclude that both  $m$  and  $x$  are induction variables of this loop. •

Expressing variables as affine expressions of loop indexes makes the series of values being computed explicit and enables several transformations. The series of values taken on by an induction variable can be computed with additions rather than multiplications. This transformation is known as "strength reduction" and was introduced in Sections 8.7 and 9.1. For instance, we can eliminate the multiplication  $x=m*3$  from the loop of Example 9.57 by rewriting the loop as

```

x = 27;
for (m = 10; m < 20; m++)
    { x = x+3; A[x] = 0; }

```

In addition, notice that the locations assigned 0 in that loop,  $A+30$ ,  $A+33$ , ...,  $A+57$ , are also affine expressions of the loop index. In fact, this series of integers is the only one that needs to be computed; We need neither  $m$  nor  $x$ . The code above can be replaced simply by:

```

for (x = A+30; x <= A+57; x = x+3)
    *x = 0;

```

Besides speeding up the computation, symbolic analysis is also useful for parallelization. When the array indexes in a loop are affine expressions of loop indexes, we can reason about relations of data accessed across the iterations. For example, we can tell that the locations written are different in each iteration and therefore all the iterations in the loop can be executed in parallel on different processors. Such information is used in Chapters 10 and 11 to extract parallelism from sequential programs.

### Other Reference Variables

If a variable is not a linear function of the reference variables already chosen, we have the option of treating its value as reference for future operations. For example, consider the code fragment:

```

a = f();
b = a + 10;
c = a + 11;

```

While the value held by  $a$  after the function call cannot itself be expressed as a linear function of any reference variables, it can be used as reference for subsequent statements. For example, using  $a$  as a reference variable, we can discover that  $c$  is one larger than  $b$  at the end of the program.

```

1)  a = 0;
2)  for (f = 100; f < 200; f++) {
3)      a = a + 1;
4)      b = 10 * a;
5)      c = 0;
6)      for (g = 10; g <
7)          d = b + c;
8)          c = c + 1;
          }
    }

```

Figure 9.55: Source code for Example 9.58

Example 9.58: Our running example for this section is based on the source code shown in Fig. 9.55. The inner and outer loops are easy to understand, since  $f$  and  $g$  are not modified except as required by the for-loops. It is thus possible to replace  $f$  and  $g$  by reference variables  $i$  and  $j$  that count the number of iterations of the outer and inner loops, respectively. That is, we can let  $f = i + 99$  and  $g = j + 9$ , and substitute for  $f$  and  $g$  throughout. When translating to intermediate code, we can take advantage of the fact that each loop iterates at least once, and so postpone the test for  $i < 100$  and  $j < 10$  to the ends of the loops. Figure 9.56 shows the flow graph for the code of Fig. 9.55, after introducing  $i$  and  $j$  and treating the for-loops as if they were repeat-loops.

It turns out that  $a$ ,  $b$ ,  $c$ , and  $d$  are all induction variables. The sequences of values assigned to the variables in each line of the code are shown in Figure 9.57. As we shall see, it is possible to discover the affine expressions for these variables, in terms of the reference variables  $i$  and  $j$ . That is, at line (4)  $a = i$ , at line (7)  $d = 10i + j - 1$ , and at line (8),  $c = j$ . •

## 9.8.2 Data-Flow Problem Formulation

This analysis finds affine expressions of reference variables introduced (1) to count the number of iterations executed in each loop, and (2) to hold values at the entry of regions where necessary. This analysis also finds induction variables, loop invariants, as well as constants, as degenerate affine expressions. Note that this analysis cannot find all constants because it only tracks affine expressions of reference variables.



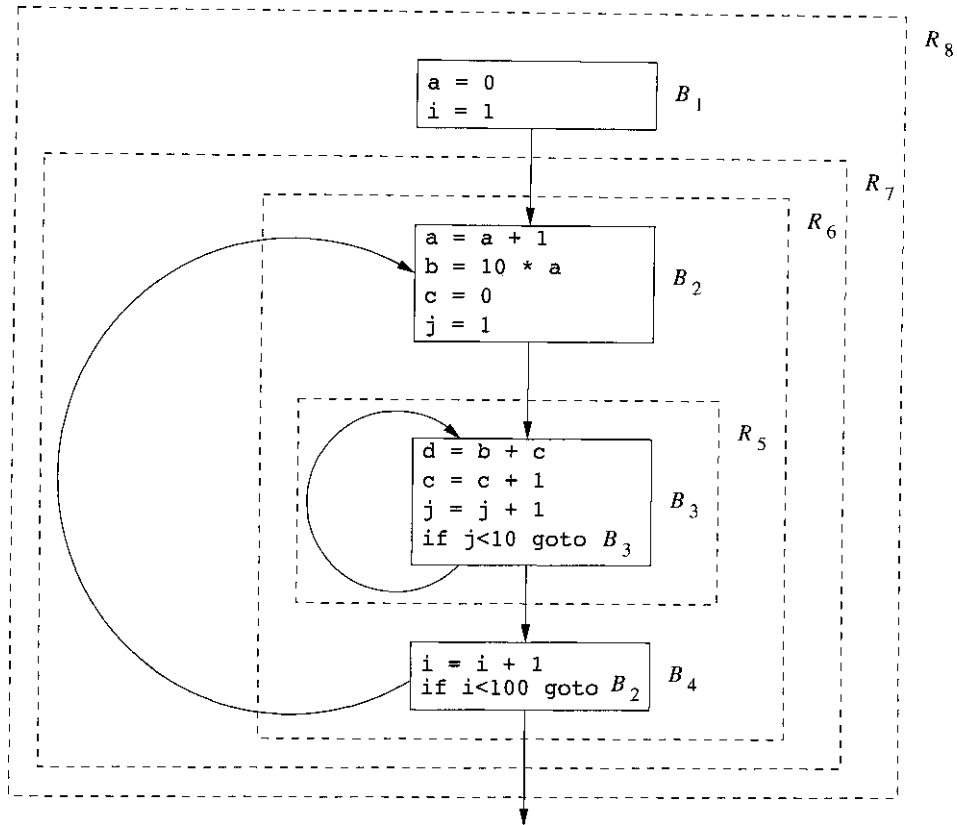

Figure 9.56: Flow graph and its region hierarchy for Example 9.58

#### Data-Flow Values: Symbolic Maps

The domain of data-flow values for this analysis is symbolic maps, which are functions that map each variable in the program to a value. The value is either an affine function of reference values, or the special symbol NAA to represent a non-affine expression. If there is only one variable, the bottom value of the semilattice is a map that sends the variable to NAA. The semilattice for  $n$  variables is simply the product of the individual semilattices. We use  $m_{\text{NAA}}$  to denote the bottom of the semilattice which maps all variables to NAA. We can define the symbolic map that sends all variables to an unknown value to be the top data-flow value, as we did for constant propagation. However, we do not need top values in region-based analysis.

Example 9.59: The symbolic maps associated with each block for the code in Example 9.58 are shown in Figure 9.58. We shall see later how these maps are discovered; they are the result of doing region-based data-flow analysis on the flow graph of Fig. 9.56.

line	var	$i = 1$ $j = 1, \dots, 10$	$i = 2$ $j = 1, \dots, 10$	$1 < i < 100$ $i = i \dots, 10$	$i = 100$ $j = 1, \dots, 10$
2	$a$	1	2	$i$	100
3	$b$	10	20	$lOi$	1000
7	$d$	10, ..., 19	20, ..., 29	10z, ..., $lOi + 9$	1000... , 1009
8	$c$	1, ..., 10	1, .. , 10	1 ... 10	1 ... 10

Figure 9.57: Sequence of values seen in program points in Example 9.58.

$m$	$m(a)$	$m(b)$	$m(c)$	$m(d)$
IN[ $B_i$ ]	NAA	NAA	NAA	NAA
OUT[ $B_i$ ]	0	NAA	NAA	NAA
IN[ $\mathcal{E}_2$ ]	$i - 1$	NAA	NAA	NAA
OUT[ $S_2$ ]	$i$	10 $\ll$	0	NAA
IN[ $B_3$ ]	$i$	10*	$i - i$	NAA
OUT[ $B_3$ ]	$i$	10?	$j$	10z + $j - 1$
IN[ $S_4$ ]	$i$	lOi	$j$	lOi + $j \sim 1$
OUT[ $B_4$ ]	$i - 1$	lOi - 10	$j$	lOi + $j - 11$

Figure 9.58: Symbolic maps of the program in Example 9.58.

The symbolic map associated with the entry of the program is  $m_{\text{NAA}}$ . At the exit of  $B_i$ , the value of  $a$  is set to 0. Upon entry to block  $B_3$ ,  $a$  has value 0 in the first iteration and increments by one in each subsequent iteration of the outer loop. Thus  $a$  has value  $i - 1$  at the entry of the  $i$ th iteration and value  $i$  at the end. The symbolic map at the entry of  $B_3$  maps variables  $b, c, d$  to NAA, because the variables have unknown values on entry to the inner loop. Their values depend on the number of iterations of the outer loop, so far. The symbolic map on exit from  $B_3$  reflects the assignment statements to  $a, b$ , and  $c$  in that block. The rest of the symbolic maps can be deduced in a similar manner. Once we have established the validity of the maps in Fig. 9.58, we can replace each of the assignments to  $a, b, c$ , and  $d$  in Fig. 9.55 by the appropriate affine expressions. That is, we can replace Fig. 9.55 by the code in Fig. 9.59.

•

### Transfer Function of a Statement

The transfer functions in this data-flow problem send symbolic maps to symbolic maps. To compute the transfer function of an assignment statement, we interpret the semantics of the statement and determine if the assigned variable can be expressed as an affine expression of the values on the right of the

```

1)  a = 0;
2)  for (i = 1; i <= 100; i++) {
3)      a = i;
4)      b = 10*i;
5)      c = 0;
6)      for (j = 1; j <= 10; j++) {
7)          d = 10*i + j - 1;
8)          c = j;
        }
    }

```

Figure 9.59: The code of Fig. 9.55 with assignments replaced by affine expressions of the reference variables  $i$  and  $j$

### Cautions Regarding Transfer Functions on Value Maps

A subtlety in the way we define the transfer functions on symbolic maps is that we have options regarding how the effects of a computation are expressed. When  $m$  is the map for the input of a transfer function,  $m(x)$  is really just "whatever value variable  $x$  happens to have on entry". We try very hard to express the result of the transfer function as an affine expression of values that are described by the input map.

You should observe the proper interpretation of expressions like  $f(m)(x)$ , where  $f$  is a transfer function,  $m$  a map, and  $x$  a variable. As is conventional in mathematics, we apply functions from the left, meaning that we first compute  $f(m)$ , which is a map. Since a map is a function, we may then apply it to variable  $x$  to produce a value.

assignment. The values of all other variables remain unchanged.

The transfer function of statement  $s$ , denoted  $f_s$ , is defined as follows:

1. If  $s$  is not an assignment statement, then  $f_s$  is the identity function.
2. If  $s$  is an assignment statement to variable  $x$ , then

$$f_s(m)(x)$$

$m(v)$	for all variables $v \neq x$
$c_0 + c_1 m(y) + c_2 m(x)$	if $x$ is assigned $c_0 + c_1 y + c_2 x$ ,
$= <$	$(c_1 = 0, \text{ or } m(y) \neq \mathbf{NAA})$ , and
$\mathbf{NAA}$	$(c_2 = 0, \text{ or } f_s(m)(x) \neq \mathbf{NAA})$
	otherwise.

The expression  $CQ + c_1a(y) + c_2m(z)$  is intended to represent all the possible forms of expressions involving arbitrary variables  $y$  and  $z$  that may appear on the right side of an assignment to  $x$  and that give  $x$  a value that is an affine transformation on prior values of variables. These expressions are:  $C_0, C_0 + y, C_0 - V_i, V_i + i, -V_i, i * V_i, \dots, y/(1/c_i)$ . Note that in many cases, one or more of  $C_0, c_i,$  and  $c_2$  are 0.

**Example 9.60:** If the assignment is  $x=y+z$ , then  $C_0 = 0$  and  $c_1 = c_2 = 1$ . If the assignment is  $x=y/5$ , then  $c_0 = c_2 = 0$ , and  $c_1 = 1/5$ . •

**Composition of Transfer Functions**

To compute  $f_2 \circ f_1$ , where  $f_1$  and  $f_2$  are defined in terms of input map  $m$ , we substitute the value of  $m(v_i)$  in the definition of  $f_2$  with the definition of  $f_1(m)(v_i)$ . We replace all operations on NAA values with NAA. That is,

1. If  $f_1(m)(v) = \text{NAA}$ , then  $(f_2 \circ f_1)(m)(v) = \text{NAA}$ .
2. If  $f_1(m)(v) = c_0 + \sum c_i m(v_i)$ , then

$$(f_2 \circ f_1)(m)(v) = \begin{cases} \text{NAA}, & \text{if } f_1(m)(v_i) = \text{NAA} \text{ for some } i \wedge 0, a \wedge 0 \\ C_0 + \sum c_i f_1(m)(v_i) & \text{otherwise} \end{cases}$$

**Example 9.61:** The transfer functions of the blocks in Example 9.58 can be computed by composing the transfer functions of their constituent statements. These transfer functions are defined in Fig. 9.60. •

$f$	$f(m)(o)$	$f(m)(b)$	$f(m)(c)$	$f(m)(d)$
$f_{B_1}$	0	$m(b)$	$m(c)$	$m(d)$
$f_{B_2}$	$m(a) + 1$	$10m(a) + 10$	0	$m(d)$
$f_{B_3}$	$m(a)$	$m(b)$	$m(c) + 1$	$m(b) + m(c)$
$f_{B_4}$	$m(a)$	$m(b)$	$m(c)$	$m(d)$

Figure 9.60: Transfer Functions of Example 9.58

**Solution to Data-Flow Problem**

We use the notation  $IN_{ij}[B_j]$  and  $OUT_{ij}[B_j]$  to refer to the input and output data-flow values of block  $B_j$  in iteration  $j$  of the inner loop and iteration  $i$  of the outer loop. For the other blocks, we use  $IN_i[B_j]$  and  $OUT_i[B_j]$  to refer to these values in the  $i$ th iteration of the outer loop. Also, we can see that

$$\begin{array}{ll}
OVT[B_i] & = \ /B(IN[5*]), \text{ for all } B_i \\
OUT[B_i] & > \ mi[B_i] \\
OVT_i[B_i] & > \ IN_{i-1}[B_i], \quad 1 < i < 10 \\
OUT_{i,j}[B_i] & > \ IN_{i-1}[B_j], \quad 1 < i < 100, 2 < j < 10 \\
OUT_{i,i}[B_i] & > \ IN_i[B_i], \quad 2 < i < 100 \\
OUT_{i,i}[B_i] & > \ IN_i[S_i], \quad 1 < i < 100
\end{array}$$

Figure 9.61: Constraints satisfied on each iteration of the nested loops

the symbolic maps shown in Fig. 9.58 satisfy the constraints imposed by the transfer functions, listed in Fig. 9.61.

The first constraint says that the output map of a basic block is obtained by applying the block's transfer function to the input map. The rest of the constraints say that the output map of a basic block must be greater than or equal to the input map of a successor block in the execution.

Note that our iterative data-flow algorithm cannot produce the above solution because it lacks the concept of expressing data-flow values in terms of the number of iterations executed. Region-based analysis can be used to find such solutions, as we shall see in the next section.

### 9.8.3 Region-Based Symbolic Analysis

We can extend the region-based analysis described in Section 9.7 to find expressions of variables in the *i*th iteration of a loop. A region-based symbolic analysis has a bottom-up pass and a top-down pass, like other region-based algorithms. The bottom-up pass summarizes the effect of a region with a transfer function that sends a symbolic map at the entry to an output symbolic map at the exit. In the top-down pass, values of symbolic maps are propagated down to the inner regions.

The difference lies in how we handle loops. In Section 9.7, the effect of a loop is summarized with a closure operator. Given a loop with body *f*, its closure *f*\* is defined as an infinite meet of all possible numbers of applications of *f*. However, to find induction variables, we need to determine if a value of a variable is an affine function of the number of iterations executed so far. The symbolic map must be parameterized by the number of the iteration being executed. Furthermore, whenever we know the total number of iterations executed in a loop, we can use that number to find the values of induction variables after the loop. For instance, in Example 9.58, we claimed that *a* has the value of *i* after executing the *i*th iteration. Since the loop has 100 iterations, the value of *a* must be 100 at the end of the loop.

In what follows, we first define the primitive operators: meet and composition of transfer functions for symbolic analysis. Then show how we use them to perform region-based analysis of induction variables.

**Meet of Transfer Functions**

When computing the meet of two functions, the value of a variable is NAA unless the two functions map the variable to the same value and the value is not NAA. Thus,

$$(f_1 \wedge f_2)(m)(v) = \begin{cases} f_1(m)(v) & \text{if } f_1(m)(v) = f_2(m)(v) \\ \text{NAA} & \text{otherwise} \end{cases}$$

**Parameterized Function Compositions**

To express a variable as an affine function of a loop index, we need to compute the effect of composing a function some given number of times. If the effect of one iteration is summarized by transfer function  $f$ , then the effect of executing  $i$  iterations, for some  $i > 0$ , is denoted  $f^i$ . Note that when  $i = 0$ ,  $f^0 = I$ , the identity function.

Variables in the program are divided into three categories:

1. If  $f(m)(x) = m(x) + c$ , where  $c$  is a constant, then  $f^i(m)(x) = m(x) + ci$  for every value of  $i > 0$ . We say that  $x$  is a *basic induction variable* of the loop whose body is represented by the transfer function  $f$ .
2. If  $f(m)(x) = m(x)$ , then  $f^i(m)(x) = m(x)$  for all  $i > 0$ . The variable  $x$  is not modified and it remains unchanged at the end of any number of iterations through the loop with transfer function  $f$ . We say that  $x$  is a *symbolic constant* in the loop.
3. If  $f(m)(x) = c_0 + c_1 m(x_1) + \dots + c_n m(x_n)$ , where each  $x_i$  is either a basic induction variable or a symbolic constant, then for  $i > 0$ ,

$$f^i(m)(x) = c_0 + c_1 i m(x_1) + \dots + c_n i m(x_n).$$

We say that  $x$  is also an induction variable, though not a basic one. Note that the formula above does not apply if  $i = 0$ .

4. In all other cases,  $f^i(m)(x) = \text{NAA}$ .

To find the effect of executing a fixed number of iterations, we simply replace  $i$  above by that number. In the case where the number of iterations is unknown, the value at the start of the last iteration is given by  $f^*$ . In this case, the only variables whose values can still be expressed in the affine form are the loop-invariant variables.

$$f^*(m)(v) = \begin{cases} m(v) & \text{if } f(m)(v) = m(v) \\ \text{NAA} & \text{otherwise} \end{cases}$$

**Example 9.62 :** For the innermost loop in Example 9.58, the effect of executing  $i$  iterations,  $i > 0$ , is summarized by  $f^i$ . From the definition of  $f$ , we see that  $a$  and  $b$  are symbolic constants,  $c$  is a basic induction variable as it is

incremented by one every iteration,  $d$  is an induction variable because it is an affine function the symbolic constant  $b$  and basic induction variable  $c$ . Thus,

$$f_{B_i}^{TM}(v) = \begin{cases} m(a) & \text{if } v = a \\ m(b) & \text{if } v = b \\ m(c) + i & \text{if } v = c \\ m(b) + m(c) + i & \text{if } v = d. \end{cases}$$

If we could not tell how many times the loop of block  $B$ , iterated, then we could not use  $/*$  and would have to use  $/*$  to express the conditions at the end of the loop. In this case, we would have

$$\left\{ \begin{array}{ll} m(a) & \text{if } v = a \\ m(b) & \text{if } v = b \\ \text{NAA} & \text{if } v = c \\ \text{NAA} & \text{if } v = d. \end{array} \right.$$

#### A Region-Based Algorithm

Algorithm 9.63 : Region-based symbolic analysis.

**INPUT:** A reducible flow graph  $G$ .

**OUTPUT:** Symbolic maps  $IN[B]$  for each block  $B$  of  $G$ .

**METHOD:** We make the following modifications to Algorithm 9.53.

1. We change how we construct the transfer function for a loop region. In the original algorithm we use the  $/*, IN[S]$  transfer function to map the symbolic map at the entry of loop region  $R$  to a symbolic map at the entry of loop body  $S$  after executing an unknown number of iterations. It is defined to be the closure of the transfer function representing all paths leading back to the entry of the loop, as shown in Fig. 9.50(b). Here we define  $/*, i, IN[S]$  to represent the effect of execution from the start of the loop region to the entry of the  $i$ th iteration. Thus,

$$f_{R,i,IN[S]} = ( \bigcup_{\text{predecessors } B \text{ in } R \text{ of the header of } S} A \quad /*, OUTpS)$$

2. If the number of iterations of a region is known, the summary of the region is computed by replacing  $i$  with the actual count.
3. In the top-down pass, we compute  $/*, i, IN[B]$  symbolic map associated with the entry of the  $i$ th iteration of a loop.

4. In the case where the input value of a variable  $m(v)$  is used on the right-hand-side of a symbolic map in region  $R$ , and  $m(v) = \text{NAA}$  upon entry to the region, we introduce a new reference variable  $t$ , add assignment  $t = v$  to the beginning of region  $R$ , and all references of  $m(v)$  are replaced by  $t$ . If we did not introduce a reference variable at this point, the NAA value held by  $v$  would penetrate into inner loops.

$$\begin{aligned}
 f_{R,j,W[B]} &= J_{B_j} \\
 /i_{j+1,OUT[B_j]} &= f_{B_j} \\
 \\ 
 /i_{j+1,IN[B_j]} &= I \\
 /ReJNfR_s &= J_{B_j} \\
 Jf_{j,OUT[/3,]} &= I \circ /j_{*,10,OUTp3,1} \circ f_i \\
 \\ 
 f_{R,i,IN[R]} &= \wedge_{*,OUT[B_j]} \\
 /f_{i,*,OUTp3,1} &= /f_{i,OUT[B_j]} \\
 \\ 
 /.R_s.INpBi &= I \\
 f_{R,IN[R]} &= /-Bi \\
 /f_{i,OUTp3,1} &= /f_{i,100,OUT[/3,]} \circ /Bi
 \end{aligned}$$

Figure 9.62: Transfer function relations in the bottom-up pass for Example 9.58.

Example 9.64: For Example 9.58, we show how the transfer functions for the program are computed in the bottom-up pass in Fig. 9.62. Region  $R_j$  is the inner loop, with body  $B_j$ . The transfer function representing the path from the entry of region  $R_j$  to the beginning of the  $j$ th iteration,  $j > 1$ , is  $f_{j+1}$ . The transfer function representing the path to the end of the  $j$ th iteration,  $j > 1$ , is  $f_j$ .

Region  $RQ$  consists of blocks  $B_i$  and  $B_j$  with loop region  $R_j$  in the middle. The transfer functions from the entry of  $B_i$  and  $R_j$  can be computed in the same way as in the original algorithm. Transfer function  $/R_{i,OUT[B_j]}$  represents the composition of block  $B_i$  and the entire execution of the inner loop, since  $f_{j+1}$  is the identity function. Since the inner loop is known to iterate 10 times, we can replace  $j$  by 10 to summarize the effect of the inner loop precisely. The



$f$	$f(m)(a)$	$f(m)(b)$	$f(m)(c)$	$f(m)(d)$
$fR_{s,j,m}[B_j]$	$m(a)$	$m(b)$	$m(c) + j - 1$	NAA
$fR_{s,j,0}JT[B_j]$	$m(a)$	$m(b)$	$m(c) + j$	$m(b) + m(c) +$
$fR_{s,i}IN[B_i]$	$m(a)$	$m(b)$	$m(c)$	$m(d)$
$fR_{s,i}W[R_i]$	$m(a) + 1$	$10m(a) + 10$	0	$m(d)$
$fR_{s,i}OUT[B_i]$	$m(a) + 1$	$10m(a) + 10$	10	$10m(a) + 9$
$fR_{s,i}IN[R_i]$	$m(a) + i - 1$	NAA	NAA	NAA
$fR_{s,i}OXJT[B_i]$	$m(a) + i$	$10m(a) + 10i$	10	$10m(a) +$ $10i + 9$
$fR_{s,W}[B_i]$	$m(a)$	$m(b)$	$m(c)$	$m(d)$
$fR_{s,W}[R_i]$	0	$m(b)$	$m(c)$	$m(d)$
$IR_{s,0}JT[B_j]$	100	1000	10	1009

Figure 9.63: Transfer functions computed in the bottom-up pass for Example 9.58

rest of the transfer functions can be computed in a similar manner. The actual transfer functions computed are shown in Fig. 9.63.

The symbolic map at the entry of the program is simply  $m_{NAA}$ . We use the top-down pass to compute the symbolic map to the entry to successively nested regions until we find all the symbolic maps for every basic block. We start by computing the data-flow values for block  $B_1$  in region  $R_5$ :

$$\begin{aligned} IN[i?i] &= m_{NAA} \\ OUT[J3i] &= f_{B_1}(IN[5I]) \end{aligned}$$

Descending down to regions  $R_4$  and  $i?6$ , we get

$$\begin{aligned} INi[B_2] &= f_{R_{s,i}}(IN[iifl](OUTp9i)) \\ ouTi[J3_2] &= f_{B_2}(IN4_2) \end{aligned}$$

Finally, in region  $R_5$ , we get

$$\begin{aligned} IN_{s}[B_j] &= f_{i?5,J}(IN[B_3]^{OUTi[52]}) \\ OUT_{s}[B_j] &= f_{B_j}(INij[B_j]) \end{aligned}$$

Not surprisingly, these equations produce the results we showed in Fig. 9.58.

•

Example 9.58 shows a simple program where every variable used in the symbolic map has an affine expression. We use Example 9.65 to illustrate why and how we introduce reference variables in Algorithm 9.63.

```

1) for (i = 1; i < n; i++) {
2)   a = input();
3)   for (j = 1; j < 10;    {
4)     a = a - 1
5)     b = j + a
6)     a = a + 1
       }
     }

```

(a) A loop where  $a$  fluctuates.

```

for (i = 1; i < n; i++) {
  a = input();
  t = a;
  for (j = 1; j < 10; j++) {
    a = t - 1;
    b = t - 1 + j;
    a = t;
  }
}

```

(b) A reference variable  $t$  makes  $b$  an induction variable.

Figure 9.64: The need to introduce reference variables

Example 9.65: Consider the simple example in Fig. 9.64(a). Let  $ff$  be the transfer function summarizing the effect of executing  $j$  iterations of the inner loop. Even though the value of  $a$  may fluctuate during the execution of the loop, we see that  $b$  is an induction variable based on the value of  $a$  on entry of the loop; that is,  $ff(m)(b) = m(a) - 1 + j$ . Because  $a$  is assigned an input value, the symbolic map upon entry to the inner loop maps  $a$  to NAA. We introduce a new reference variable  $t$  to save the value of  $a$  upon entry, and perform the substitutions as in Fig. 9.64(b). •

### 9.8.4 Exercises for Section 9.8

Exercise 9.8.1: For the flow graph of Fig. 9.10 (see the exercises for Section 9.1), give the transfer functions for

- a) Block  $B_1$ .
- b) Block  $B_2$ .
- c) Block  $B_3$ .

Exercise 9.8.2: Consider the inner loop of Fig. 9.10, consisting of blocks  $B_i$  and  $B_e$ . If  $i$  represents the number of times around the loop, and  $f$  is the transfer function for the loop body (i.e., excluding the edge from  $B_i$  to  $B_e$ ) from the entry of the loop (i.e., the beginning of  $B_i$ ) to the exit from  $B_e$ , then what is  $f^i$ ? Remember that  $f$  takes as argument a map  $m$ , and  $m$  assigns a value to each of variables  $a$ ,  $b$ ,  $d$ , and  $e$ . We denote these values  $m(o)$ , and so on, although we do not know their values.

Exercise 9.8.3: Now consider the outer loop of Fig. 9.10, consisting of blocks  $B_1$ ,  $B_2$ ,  $B_3$ , and  $B_4$ . Let  $g$  be the transfer function for the loop body, from the entry of the loop at  $B_2$  to its exit at  $B_4$ . Let  $i$  measure the number of iterations of the inner loop of  $B_2$  and  $B_3$  (which count of iterations we cannot know), and let  $j$  measure the number of iterations of the outer loop (which we also cannot know). What is  $g^j$ ?

## 9.9 Summary of Chapter 9

- 4- *Global Common Subexpressions:* An important optimization is finding computations of the same expression in two different basic blocks. If one precedes the other, we can store the result the first time it is computed and use the stored result on subsequent occurrences.
- *Copy Propagation:* A copy statement,  $u \leftarrow v$ , assigns one variable  $v$  to another,  $u$ . In some circumstances, we can replace all uses of  $u$  by  $v$ , thus eliminating both the assignment and  $u$ .
- *Code Motion:* Another optimization is to move a computation outside the loop in which it appears. This change is only correct if the computation produces the same value each time around the loop.
- *Induction Variables:* Many loops have induction variables, variables that take on a linear sequence of values each time around the loop. Some of these are used only to count iterations, and they often can be eliminated, thus reducing the time it takes to go around the loop.
- *Data-Flow Analysis:* A data-flow analysis schema defines a value at each point in the program. Statements of the program have associated transfer functions that relate the value before the statement to the value after. Statements with more than one predecessor must have their value defined by combining the values at the predecessors, using a meet (or confluence) operator.
- 4- *Data-Flow Analysis on Basic Blocks:* Because the propagation of data-flow values within a block is usually quite simple, data-flow equations are generally set up to have two variables for each block, called IN and OUT, that represent the data-flow values at the beginning and end of the

block, respectively. The transfer functions for the statements in a block are composed to get the transfer function for the block as a whole.

- 4 *Reaching Definitions:* The reaching-definitions data-flow framework has values that are sets of statements in the program that define values for one or more variables. The transfer function for a block kills definitions of variables that are definitely redefined in the block and adds ("generates") in those definitions of variables that occur within the block. The confluence operator is union, since definitions reach a point if they reach any predecessor of that point.
- 4 *Live Variables:* Another important data-flow framework computes the variables that are live (will be used before redefinition) at each point. The framework is similar to reaching definitions, except that the transfer function runs backward. A variable is live at the beginning of a block if it is either used before definition in the block or is live at the end of the block and not redefined in the block.
- 4 *Available Expressions:* To discover global common subexpressions, we determine the available expressions at each point — expressions that have been computed and neither of the expression's arguments were redefined after the last computation. The data-flow framework is similar to reaching definitions, but the confluence operator is intersection rather than union.
- 4 *Abstraction of Data-Flow Problems:* Common data-flow problems, such as those already mentioned, can be expressed in a common mathematical structure. The values are members of a semilattice, whose meet is the confluence operator. Transfer functions map lattice elements to lattice elements. The set of allowed transfer functions must be closed under composition and include the identity function.
- 4 *Monotone Frameworks:* A semilattice has a  $<$  relation defined by  $a < b$  if and only if  $a \wedge b = a$ . Monotone frameworks have the property that each transfer function preserves the  $<$  relationship; that is,  $a < b$  implies  $f(a) < f(b)$ , for all lattice elements  $a$  and  $b$  and transfer function  $f$ .
- 4 *Distributive Frameworks:* These frameworks satisfy the condition that  $f(a \wedge b) = f(a) \wedge f(b)$ , for all lattice elements  $a$  and  $b$  and transfer function  $f$ . It can be shown that the distributive condition implies the monotone condition.
- 4 *Iterative Solution to Abstract Frameworks:* All monotone data-flow frameworks can be solved by an iterative algorithm, in which the IN and OUT values for each block are initialized appropriately (depending on the framework), and new values for these variables are repeatedly computed by applying the transfer and confluence operations. This solution is always safe (optimizations that it suggests will not change what the

program does), but the solution is certain to be the best possible only if the framework is distributive.

- *The Constant Propagation Framework:* While the basic frameworks such as reaching definitions are distributive, there are interesting monotone-but-not-distributive frameworks as well. One involves propagating constants by using a semilattice whose elements are mappings from the program variables to constants, plus two special values that represent "no information" and "definitely not a constant."
  - *Partial-Redundancy Elimination:* Many useful optimizations, such as code motion and global common-subexpression elimination, can be generalized to a single problem called partial-redundancy elimination. Expressions that are needed, but are available along only some of the paths to a point, are computed only along the paths where they are not available. The correct application of this idea requires the solution to a sequence of four different data-flow problems plus other operations.
  - *Dominators:* A node in a flow graph dominates another if every path to the latter must go through the former. A proper dominator is a dominator other than the node itself. Each node except the entry node has an immediate dominator — that one of its proper dominators that is dominated by all the other proper dominators.
- 4 *Depth-First Ordering of Flow Graphs:* If we perform a depth-first search of a flow graph, starting at its entry, we produce a depth-first spanning tree. The depth-first order of the nodes is the reverse of a postorder traversal of this tree.
  - 4- *Classification of Edges:* When we construct a depth-first spanning tree, all the edges of the flow graph can be divided into three groups: advancing edges (those that go from ancestor to proper descendant), retreating edges (those from descendant to ancestor) and cross edges (others). An important property is that all the cross edges go from right to left in the tree. Another important property is that of these edges, only the retreating edges have a head lower than its tail in the depth-first order (reverse postorder).
  - *Back Edges:* A back edge is one whose head dominates its tail. Every back edge is a retreating edge, regardless of which depth-first spanning tree for its flow graph is chosen.
  - 4 *Reducible Flow Graphs:* If every retreating edge is a back edge, regardless of which depth-first spanning tree is chosen, then the flow graph is said to be reducible. The vast majority of flow graphs are reducible; those whose only control-flow statements are the usual loop-forming and branching statements are certainly reducible.

- 4 *Natural Loops*: A natural loop is a set of nodes with a header node that dominates all the nodes in the set and has at least one back edge entering that node. Given any back edge, we can construct its natural loop by taking the head of the edge plus all nodes that can reach the tail of the edge without going through the head. Two natural loops with different headers are either disjoint or one is completely contained in the other; this fact lets us talk about a hierarchy of nested loops, as long as "loops" are taken to be natural loops.
- 4 *Depth-First Order Makes the Rerative Algorithm Efficient*: The iterative algorithm requires few passes, as long as propagation of information along acyclic paths is sufficient; i.e., cycles add nothing. If we visit nodes in depth-first order, any data-flow framework that propagates information forward, e.g., reaching definitions, will converge in no more than 2 plus the largest number of retreating edges on any acyclic path. The same holds for backward-propagating frameworks, like live variables, if we visit in the reverse of depth-first order (i.e., in postorder).
- 4 *Regions*: Regions are sets of nodes and edges with a header  $h$  that dominates all nodes in the region. The predecessors of any node other than  $h$  in the region must also be in the region. The edges of the region are all that go between nodes of the region, with the possible exception of some or all that enter the header.
- 4 *Regions and Reducible Flow Graphs*: Reducible flow graphs can be parsed into a hierarchy of regions. These regions are either loop regions, which include all the edges into the header, or body regions that have no edges into the header.
- 4 *Region-Based Data-Flow Analysis*: An alternative to the iterative approach to data-flow analysis is to work up and down the region hierarchy, computing transfer functions from the header of each region to each node in that region.
- 4 *Region-Based Induction Variable Detection*: An important application of region-based analysis is in a data-flow framework that tries to compute formulas for each variable in a loop region whose value is an affine (linear) function of the number of times around the loop.

## 9.10 References for Chapter 9

Two early compilers that did extensive code optimization are Alpha [7] and Fortran H [16]. The fundamental treatise on techniques for loop optimization (e.g., code motion) is [1], although earlier versions of some of these ideas appear in [8]. An informally distributed book [4] was influential in disseminating code-optimization ideas.

The first description of the iterative algorithm for data-flow analysis is from the unpublished technical report of Vyssotsky and Wegner [20]. The scientific study of data-flow analysis is said to begin with a pair of papers by Allen [2] and Cocke [3].

The lattice-theoretic abstraction described here is based on the work of Kildall [13]. These frameworks assumed distributivity, which many frameworks do not satisfy. After a number of such frameworks came to light, the monotonicity condition was embedded in the model by [5] and [11].

Partial-redundancy elimination was pioneered by [17]. The lazy-code-motion algorithm described in this chapter is based on [14].

Dominators were first used in the compiler described in [13]. However, the idea dates back to [18].

The notion of reducible flow graphs comes from [2]. The structure of these flow graphs, as presented here, is from [9] and [10]. [12] and [15] first connected reducibility of flow graphs to the common nested control-flow structures, which explains why this class of flow graphs is so common.

The definition of reducibility by  $T1$ - $T2$  reduction, as used in region-based analysis, is from [19]. The region-based approach was first used in a compiler described in [21].

The static single-assignment (SSA) form of intermediate representation introduced in Section 6.1 incorporates both data flow and control flow into its representation. SSA facilitates the implementation of many optimizing transformations from a common framework [6].

1. Allen, F. E., "Program optimization," *Annual Review in Automatic Programming* **5** (1969), pp. 239-307.
2. Allen, F. E., "Control flow analysis," *ACM Sigplan Notices* **5:7** (1970), pp. 1-19.
3. Cocke, J., "Global common subexpression elimination," *ACM SIGPLAN Notices* **5:7** (1970), pp. 20-24.
4. Cocke, J. and J. T. Schwartz, *Programming Languages and Their Compilers: Preliminary Notes*, Courant Institute of Mathematical Sciences, New York Univ., New York, 1970.
5. Cousot, P. and R. Cousot, "Abstract interpretation: a unified lattice model for static analysis of programs by construction or approximation of fixpoints," *Fourth ACM Symposium on Principles of Programming Languages* (1977), pp. 238-252.
6. Cytron, R., J. Ferrante, B. K. Rosen, M. N. Wegman, and F. K. Zadeck, "Efficiently computing static single assignment form and the control dependence graph," *ACM Transactions on Programming Languages and Systems* **13:4** (1991), pp. 451-490.

7. Ershov, A. P., "Alpha — an automatic programming system of high efficiency," *J. ACM* **13**:1 (1966), pp. 17-24.
8. Gear, C. W., "High speed compilation of efficient object code," *Comm. ACM* **8**:8 (1965), pp. 483-488.
9. Hecht, M. S. and J. D. Ullman, "Flow graph reducibility," *SI AM J. Computing* **1** (1972), pp. 188-202.
10. Hecht, M. S. and J. D. Ullman, "Characterizations of reducible flow graphs," *J. ACM* **21** (1974), pp. 367-375.
11. Kam, J. B. and J. D. Ullman, "Monotone data flow analysis frameworks," *Acta Informatica* **7**:3 (1977), pp. 305-318.
12. Kasami, T., W. W. Peterson, and N. Tokura, "On the capabilities of while, repeat, and exit statements," *Comm. ACM* **16**:8 (1973), pp. 503-512.
13. Kildall, G., "A unified approach to global program optimization," *ACM Symposium on Principles of Programming Languages* (1973), pp. 194-206.
14. Knoop, J., "Lazy code motion," *Proc. ACM SIGPLAN 1992 conference on Programming Language Design and Implementation*, pp. 224-234.
15. Kosaraju, S. R., "Analysis of structured programs," *J. Computer and System Sciences* **9**:3 (1974), pp. 232-255.
16. Lowry, E. S. and C. W. Medlock, "Object code optimization," *Comm. ACM* **12**:1 (1969), pp. 13-22.
17. Morel, E. and C. Renvoise, "Global optimization by suppression of partial redundancies," *Comm. ACM* **22** (1979), pp. 96-103.
18. Prosser, R. T., "Application of boolean matrices to the analysis of flow diagrams," *AFIPS Eastern Joint Computer Conference* (1959), Spartan Books, Baltimore MD, pp. 133-138.
19. Ullman, J. D., "Fast algorithms for the elimination of common subexpressions," *Acta Informatica* **2** (1973), pp. 191-213.
20. Vyssotsky, V. and P. Wegner, "A graph theoretical Fortran source language analyzer," unpublished technical report, Bell Laboratories, Murray Hill NJ, 1963.
21. Wulf, W. A., R. K. Johnson, C. B. Weinstock, S. O. Hobbs, and C. M. Geschke, *The Design of an Optimizing Compiler*, Elsevier, New York, 1975.





## Chapter 10

# Instruction-Level Parallelism

Every modern high-performance processor can execute several operations in a single clock cycle. The "billion-dollar question" is how fast can a program be run on a processor with instruction-level parallelism? The answer depends on:

1. The potential parallelism in the program.
2. The available parallelism on the processor.
3. Our ability to extract parallelism from the original sequential program.
4. Our ability to find the best parallel schedule given scheduling constraints.

If all the operations in a program are highly dependent upon one another, then no amount of hardware or parallelization techniques can make the program run fast in parallel. There has been a lot of research on understanding the limits of parallelization. Typical nonnumeric applications have many inherent dependences. For example, these programs have many data-dependent branches that make it hard even to predict which instructions are to be executed, let alone decide which operations can be executed in parallel. Therefore, work in this area has focused on relaxing the scheduling constraints, including the introduction of new architectural features, rather than the scheduling techniques themselves.

Numeric applications, such as scientific computing and signal processing, tend to have more parallelism. These applications deal with large aggregate data structures; operations on distinct elements of the structure are often independent of one another and can be executed in parallel. Additional hardware resources can take advantage of such parallelism and are provided in high-performance, general-purpose machines and digital signal processors. These programs tend to have simple control structures and regular data-access patterns, and static techniques have been developed to extract the available parallelism from these programs. Code scheduling for such applications is interesting

and significant, as they offer a large number of independent operations to be mapped onto a large number of resources.

Both parallelism extraction and scheduling for parallel execution can be performed either statically in software, or dynamically in hardware. In fact, even machines with hardware scheduling can be aided by software scheduling. This chapter starts by explaining the fundamental issues in using instruction-level parallelism, which is the same regardless of whether the parallelism is managed by software or hardware. We then motivate the basic data-dependence analyses needed for the extraction of parallelism. These analyses are useful for many optimizations other than instruction-level parallelism as we shall see in Chapter 11.

Finally, we present the basic ideas in code scheduling. We describe a technique for scheduling basic blocks, a method for handling highly data-dependent control flow found in general-purpose programs, and finally a technique called software pipelining that is used primarily for scheduling numeric programs.

## 10.1 Processor Architectures

When we think of instruction-level parallelism, we usually imagine a processor issuing several operations in a single clock cycle. In fact, it is possible for a machine to issue just one operation per clock<sup>1</sup> and yet achieve instruction-level parallelism using the concept of *pipelining*. In the following, we shall first explain pipelining then discuss multiple-instruction issue.

### 10.1.1 Instruction Pipelines and Branch Delays

Practically every processor, be it a high-performance supercomputer or a standard machine, uses an *instruction pipeline*. With an instruction pipeline, a new instruction can be fetched every clock while preceding instructions are still going through the pipeline. Shown in Fig. 10.1 is a simple 5-stage instruction pipeline: it first fetches the instruction (IF), decodes it (ID), executes the operation (EX), accesses the memory (MEM), and writes back the result (WB). The figure shows how instructions  $i$ ,  $i + 1$ ,  $i + 2$ ,  $i + 3$ , and  $i + 4$  can execute at the same time. Each row corresponds to a clock tick, and each column in the figure specifies the stage each instruction occupies at each clock tick.

If the result from an instruction is available by the time the succeeding instruction needs the data, the processor can issue an instruction every clock. Branch instructions are especially problematic because until they are fetched, decoded and executed, the processor does not know which instruction will execute next. Many processors speculatively fetch and decode the immediately succeeding instructions in case a branch is not taken. When a branch is found to be taken, the instruction pipeline is emptied and the branch target is fetched.

<sup>1</sup>We shall refer to a clock "tick" or clock cycle simply as a "clock," when the intent is clear.

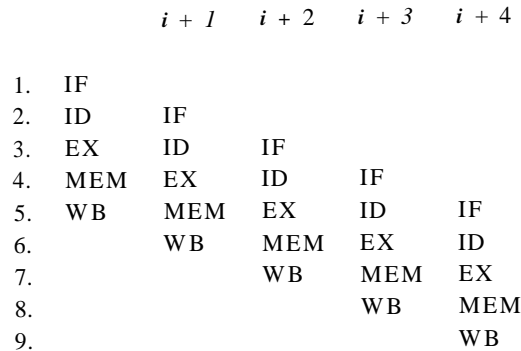

Figure 10.1: Five consecutive instructions in a 5-stage instruction pipeline

Thus, taken branches introduce a delay in the fetch of the branch target and introduce "hiccups" in the instruction pipeline. Advanced processors use hardware to predict the outcomes of branches based on their execution history and to prefetch from the predicted target locations. Branch delays are nonetheless observed if branches are mispredicted.

### 10.1.2 Pipelined Execution

Some instructions take several clocks to execute. One common example is the memory-load operation. Even when a memory access hits in the cache, it usually takes several clocks for the cache to return the data. We say that the execution of an instruction is *pipelined* if succeeding instructions not dependent on the result are allowed to proceed. Thus, even if a processor can issue only one operation per clock, several operations might be in their execution stages at the same time. If the deepest execution pipeline has  $n$  stages, potentially  $n$  operations can be "in flight" at the same time. Note that not all instructions are fully pipelined. While floating-point adds and multiplies often are fully pipelined, floating-point divides, being more complex and less frequently executed, often are not.

Most general-purpose processors dynamically detect dependences between consecutive instructions and automatically stall the execution of instructions if their operands are not available. Some processors, especially those embedded in hand-held devices, leave the dependence checking to the software in order to keep the hardware simple and power consumption low. In this case, the compiler is responsible for inserting "no-op" instructions in the code if necessary to assure that the results are available when needed.

### 10.1.3 Multiple Instruction Issue

By issuing several operations per clock, processors can keep even more operations in flight. The largest number of operations that can be executed simultaneously can be computed by multiplying the instruction issue width by the average number of stages in the execution pipeline.

Like pipelining, parallelism on multiple-issue machines can be managed either by software or hardware. Machines that rely on software to manage their parallelism are known as *VLIW* (Very-Long-Instruction-Word) machines, while those that manage their parallelism with hardware are known as *superscalar* machines. VLIW machines, as their name implies, have wider than normal instruction words that encode the operations to be issued in a single clock. The compiler decides which operations are to be issued in parallel and encodes the information in the machine code explicitly. Superscalar machines, on the other hand, have a regular instruction set with an ordinary sequential-execution semantics. Superscalar machines automatically detect dependences among instructions and issue them as their operands become available. Some processors include both VLIW and superscalar functionality.

Simple hardware schedulers execute instructions in the order in which they are fetched. If a scheduler comes across a dependent instruction, it and all instructions that follow must wait until the dependences are resolved (i.e., the needed results are available). Such machines obviously can benefit from having a static scheduler that places independent operations next to each other in the order of execution.

More sophisticated schedulers can execute instructions "out of order." Operations are independently stalled and not allowed to execute until all the values they depend on have been produced. Even these schedulers benefit from static scheduling, because hardware schedulers have only a limited space in which to buffer operations that must be stalled. Static scheduling can place independent operations close together to allow better hardware utilization. More importantly, regardless how sophisticated a dynamic scheduler is, it cannot execute instructions it has not fetched. When the processor has to take an unexpected branch, it can only find parallelism among the newly fetched instructions. The compiler can enhance the performance of the dynamic scheduler by ensuring that these newly fetched instructions can execute in parallel.

## 10.2 Code-Scheduling Constraints

Code scheduling is a form of program optimization that applies to the machine code that is produced by the code generator. Code scheduling is subject to three kinds of constraints:

1. *Control-dependence constraints.* All the operations executed in the original program must be executed in the optimized one.

2. *Data-dependence constraints.* The operations in the optimized program must produce the same results as the corresponding ones in the original program.
3. *Resource constraints.* The schedule must not oversubscribe the resources on the machine.

These scheduling constraints guarantee that the optimized program produces the same results as the original. However, because code scheduling changes the order in which the operations execute, the state of the memory at any one point may not match any of the memory states in a sequential execution. This situation is a problem if a program's execution is interrupted by, for example, a thrown exception or a user-inserted breakpoint. Optimized programs are therefore harder to debug. Note that this problem is not specific to code scheduling but applies to all other optimizations, including partial-redundancy elimination (Section 9.5) and register allocation (Section 8.8).

### 10.2.1 Data Dependence

It is easy to see that if we change the execution order of two operations that do not touch any of the same variables, we cannot possibly affect their results. In fact, even if these two operations read the same variable, we can still permute their execution. Only if an operation writes to a variable read or written by another can changing their execution order alter their results. Such pairs of operations are said to share a *data dependence*, and their relative execution order must be preserved. There are three flavors of data dependence:

1. *True dependence:* read after write. If a write is followed by a read of the same location, the read depends on the value written; such a dependence is known as a true dependence.
2. *Antidependence:* write after read. If a read is followed by a write to the same location, we say that there is an antidependence from the read to the write. The write does not depend on the read per se, but if the write happens before the read, then the read operation will pick up the wrong value. Antidependence is a byproduct of imperative programming, where the same memory locations are used to store different values. It is not a "true" dependence and potentially can be eliminated by storing the values in different locations.
3. *Output dependence:* write after write. Two writes to the same location share an output dependence. If the dependence is violated, the value of the memory location written will have the wrong value after both operations are performed.

Antidependence and output dependences are referred to as *storage-related dependences*. These are not "true" dependences and can be eliminated by using

different locations to store different values. Note that data dependences apply to both memory accesses and register accesses.

### 10.2.2 Finding Dependences Among Memory Accesses

To check if two memory accesses share a data dependence, we only need to tell if they can refer to the same location; we do not need to know which location is being accessed. For example, we can tell that the two accesses `*p` and `Op)+4` cannot refer to the same location, even though we may not know what  $p$  points to. Data dependence is generally undecidable at compile time. The compiler must assume that operations may refer to the same location unless it can prove otherwise.

Example 10.1: Given the code sequence

```
1)  a  =  1;
2)  *p =  2;
3)  x  =  a;
```

unless the compiler knows that  $p$  cannot possibly point to `a`, it must conclude that the three operations need to execute serially. There is an output dependence flowing from statement (1) to statement (2), and there are two true dependences flowing from statements (1) and (2) to statement (3). •

Data-dependence analysis is highly sensitive to the programming language used in the program. For type-unsafe languages like C and C++, where a pointer can be cast to point to any kind of object, sophisticated analysis is necessary to prove independence between any pair of pointer-based memory accesses. Even local or global scalar variables can be accessed indirectly unless we can prove that their addresses have not been stored anywhere by any instruction in the program. In type-safe languages like Java, objects of different types are necessarily distinct from each other. Similarly, local primitive variables on the stack cannot be aliased with accesses through other names.

A correct discovery of data dependences requires a number of different forms of analysis. We shall focus on the major questions that must be resolved if the compiler is to detect all the dependences that exist in a program, and how to use this information in code scheduling. Later chapters show how these analyses are performed.

#### Array Data-Dependence Analysis

Array data dependence is the problem of disambiguating between the values of indexes in array-element accesses. For example, the loop

```
for (i = 0; i < n; i++)
    A[2*i] = A[2*i+1];
```

copies odd elements in the array  $A$  to the even elements just preceding them. Because all the read and written locations in the loop are distinct from each other, there are no dependences between the accesses, and all the iterations in the loop can execute in parallel. Array data-dependence analysis, often referred to simply as *data-dependence analysis*, is very important for the optimization of numerical applications. This topic will be discussed in detail in Section 11.6.

### Pointer-Alias Analysis

We say that two pointers are *aliased* if they can refer to the same object. Pointer-alias analysis is difficult because there are many potentially aliased pointers in a program, and they can each point to an unbounded number of dynamic objects over time. To get any precision, pointer-alias analysis must be applied across all the functions in a program. This topic is discussed starting in Section 12.4.

### Interprocedural Analysis

For languages that pass parameters by reference, interprocedural analysis is needed to determine if the same variable is passed as two or more different arguments. Such aliases can create dependences between seemingly distinct parameters. Similarly, global variables can be used as parameters and thus create dependences between parameter accesses and global variable accesses. Interprocedural analysis, discussed in Chapter 12, is necessary to determine these aliases.

## 10.2.3 Tradeoff Between Register Usage and Parallelism

In this chapter we shall assume that the machine-independent intermediate representation of the source program uses an unbounded number of *pseudoregisters* to represent variables that can be allocated to registers. These variables include scalar variables in the source program that cannot be referred to by any other names, as well as temporary variables that are generated by the compiler to hold the partial results in expressions. Unlike memory locations, registers are uniquely named. Thus precise data-dependence constraints can be generated for register accesses easily.

The unbounded number of pseudoregisters used in the intermediate representation must eventually be mapped to the small number of physical registers available on the target machine. Mapping several pseudoregisters to the same physical register has the unfortunate side effect of creating artificial storage dependences that constrain instruction-level parallelism. Conversely, executing instructions in parallel creates the need for more storage to hold the values being computed simultaneously. Thus, the goal of minimizing the number of registers used conflicts directly with the goal of maximizing instruction-level parallelism. Examples 10.2 and 10.3 below illustrate this classic trade-off between storage and parallelism.



## Hardware Register Renaming

Instruction-level parallelism was first used in computer architectures as a means to speed up ordinary sequential machine code. Compilers at the time were not aware of the instruction-level parallelism in the machine and were designed to optimize the use of registers. They deliberately reordered instructions to minimize the number of registers used, and as a result, also minimized the amount of parallelism available. Example 10.3 illustrates how minimizing register usage in the computation of expression trees also limits its parallelism.

There was so little parallelism left in the sequential code that computer architects invented the concept of *hardware register renaming* to undo the effects of register optimization in compilers. Hardware register renaming dynamically changes the assignment of registers as the program runs. It interprets the machine code, stores values intended for the same register in different internal registers, and updates all their uses to refer to the right registers accordingly.

Since the artificial register-dependence constraints were introduced by the compiler in the first place, they can be eliminated by using a register-allocation algorithm that is cognizant of instruction-level parallelism. Hardware register renaming is still useful in the case when a machine's instruction set can only refer to a small number of registers. This capability allows an implementation of the architecture to map the small number of architectural registers in the code to a much larger number of internal registers dynamically.

Example 10.2: The code below copies the values of variables in locations *a* and *c* to variables in locations *b* and *d*, respectively, using pseudoregisters *t1* and *t2*.

```
LD t1, a    // t1 = a
ST b, t1    // b = t1
LD t2, c    // t2 = c
ST d, t2    // d = t2
```

If all the memory locations accessed are known to be distinct from each other, then the copies can proceed in parallel. However, if *t1* and *t2* are assigned the same register so as to minimize the number of registers used, the copies are necessarily serialized. •

Example 10.3: Traditional register-allocation techniques aim to minimize the number of registers used when performing a computation. Consider the expression

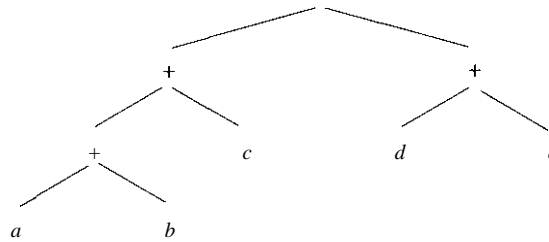

Figure 10.2: Expression tree in Example 10.3

$$(a + b) + c + (d + e)$$

shown as a syntax tree in Fig. 10.2. It is possible to perform this computation using three registers, as illustrated by the machine code in Fig. 10.3.

```

LD r1, a      // r1 = a
LD r2, b      // r2 = b
ADD r1, r1, r2 // r1 = r1+r2
LD r2, c      // r2 = c
ADD r1, r1, r2 // r1 = r1+r2
LD r2, d      // r2 = d
LD r3, e      // r3 = e
ADD r2, r2, r3 // r2 = r2+r3
ADD r1, r1, r2 // r1 = r1+r2
  
```

Figure 10.3: Machine code for expression of Fig. 10.2

The reuse of registers, however, serializes the computation. The only operations allowed to execute in parallel are the loads of the values in locations **a** and **b**, and the loads of the values in locations **d** and **e**. It thus takes a total of 7 steps to complete the computation in parallel.

Had we used different registers for every partial sum, the expression could be evaluated in 4 steps, which is the height of the expression tree in Fig. 10.2. The parallel computation is suggested by Fig. 10.4. •

r1 = a	r2 = b	r3 = c   r4 = d   r5 = e
r6 = r1+r2	r7 = r4+r5	
r8 = r6+r3		
r9 = r8+r7		

Figure 10.4: Parallel evaluation of the expression of Fig. 10.2

### 10.2.4 Phase Ordering Between Register Allocation and Code Scheduling

If registers are allocated before scheduling, the resulting code tends to have many storage dependences that limit code scheduling. On the other hand, if code is scheduled before register allocation, the schedule created may require so many registers that register *spilling* (storing the contents of a register in a memory location, so the register can be used for some other purpose) may negate the advantages of instruction-level parallelism. Should a compiler allocate registers first before it schedules the code? Or should it be the other way round? Or, do we need to address these two problems at the same time?

To answer the questions above, we must consider the characteristics of the programs being compiled. Many nonnumeric applications do not have that much available parallelism. It suffices to dedicate a small number of registers for holding temporary results in expressions. We can first apply a coloring algorithm, as in Section 8.8.4, to allocate registers for all the nontemporary variables, then schedule the code, and finally assign registers to the temporary variables.

This approach does not work for numeric applications where there are many more large expressions. We can use a hierarchical approach where code is optimized inside out, starting with the innermost loops. Instructions are first scheduled assuming that every pseudoregister will be allocated its own physical register. Register allocation is applied after scheduling and spill code is added where necessary, and the code is then rescheduled. This process is repeated for the code in the outer loops. When several inner loops are considered together in a common outer loop, the same variable may have been assigned different registers. We can change the register assignment to avoid having to copy the values from one register to another. In Section 10.5, we shall discuss the interaction between register allocation and scheduling further in the context of a specific scheduling algorithm.

### 10.2.5 Control Dependence

Scheduling operations within a basic block is relatively easy because all the instructions are guaranteed to execute once control flow reaches the beginning of the block. Instructions in a basic block can be reordered arbitrarily, as long as all the data dependences are satisfied. Unfortunately, basic blocks, especially in nonnumeric programs, are typically very small; on average, there are only about five instructions in a basic block. In addition, operations in the same block are often highly related and thus have little parallelism. Exploiting parallelism across basic blocks is therefore crucial.

An optimized program must execute all the operations in the original program. It can execute more instructions than the original, as long as the extra instructions do not change what the program does. Why would executing extra instructions speed up a program's execution? If we know that an instruction

is likely to be executed, and an idle resource is available to perform the operation "for free," we can execute the instruction *speculatively*. The program runs faster when the speculation turns out to be correct.

An instruction  $n$  is said to be *control-dependent* on instruction  $i$ , if the outcome of  $i$ , determines whether  $n$  is to be executed. The notion of control dependence corresponds to the concept of nesting levels in block-structured programs. Specifically, in the if-else statement

```
if (c) s1; else s2;
```

$s1$  and  $s2$  are control dependent on  $c$ . Similarly, in the while-statement

```
while (c) s;
```

the body  $s$  is control dependent on  $c$ .

**Example 10.4:** In the code fragment

```
if (a > t)
    b = a*a;
d = a+c;
```

the statements  $b = a*a$  and  $d = a+c$  have no data dependence with any other part of the fragment. The statement  $b = a*a$  depends on the comparison  $a > t$ . The statement  $d = a+c$ , however, does not depend on the comparison and can be executed any time. Assuming that the multiplication  $a * a$  does not cause any side effects, it can be performed speculatively, as long as  $b$  is written only after  $a$  is found to be greater than  $t$ . •

### 10.2.6 Speculative Execution Support

Memory loads are one type of instruction that can benefit greatly from speculative execution. Memory loads are quite common, of course. They have relatively long execution latencies, addresses used in the loads are commonly available in advance, and the result can be stored in a new temporary variable without destroying the value of any other variable. Unfortunately, memory loads can raise exceptions if their addresses are illegal, so speculatively accessing illegal addresses may cause a correct program to halt unexpectedly. Besides, mispredicted memory loads can cause extra cache misses and page faults, which are extremely costly.

**Example 10.5:** In the fragment

```
if (p != null)
    q = *P;
```

dereferencing  $p$  speculatively will cause this correct program to halt in error if  $p$  is null. •

Many high-performance processors provide special features to support speculative memory accesses. We mention the most important ones next.

### Prefetching

The *prefetch* instruction was invented to bring data from memory to the cache before it is used. A *prefetch* instruction indicates to the processor that the program is likely to use a particular memory word in the near future. If the location specified is invalid or if accessing it causes a page fault, the processor can simply ignore the operation. Otherwise, the processor will bring the data from memory to the cache if it is not already there.

### Poison Bits

Another architectural feature called *poison bits* was invented to allow speculative load of data from memory into the register file. Each register on the machine is augmented with a *poison* bit. If illegal memory is accessed or the accessed page is not in memory, the processor does not raise the exception immediately but instead just sets the poison bit of the destination register. An exception is raised only if the contents of the register with a marked poison bit are used.

### Predicated Execution

Because branches are expensive, and mispredicted branches are even more so (see Section 10.1), *predicated instructions* were invented to reduce the number of branches in a program. A predicated instruction is like a normal instruction but has an extra predicate operand to guard its execution; the instruction is executed only if the predicate is found to be true.

As an example, a conditional move instruction **CMOVZ R2,R3,R1** has the semantics that the contents of register **R3** are moved to register **R2** only if register **R1** is zero. Code such as

```
if (a == 0)
    b = c+d;
```

can be implemented with two machine instructions, assuming that *a*, *b*, *c*, and *d* are allocated to registers **R1**, **R2**, **R4**, **R5**, respectively, as follows:

```
ADD   R3, R4, R5
CMOVZ R2, R3, R1
```

This conversion replaces a series of instructions sharing a control dependence with instructions sharing only data dependences. These instructions can then be combined with adjacent basic blocks to create a larger basic block. More importantly, with this code, the processor does not have a chance to mispredict, thus guaranteeing that the instruction pipeline will run smoothly.

Predicated execution does come with a cost. Predicated instructions are fetched and decoded, even though they may not be executed in the end. Static schedulers must reserve all the resources needed for their execution and ensure

## Dynamically Scheduled Machines

The instruction set of a statically scheduled machine explicitly defines what can execute in parallel. However, recall from Section 10.1.2 that some machine architectures allow the decision to be made at run time about what can be executed in parallel. With dynamic scheduling, the same machine code can be run on different members of the same family (machines that implement the same instruction set) that have varying amounts of parallel-execution support. In fact, machine-code compatibility is one of the major advantages of dynamically scheduled machines.

Static schedulers, implemented in the compiler by software, can help dynamic schedulers (implemented in the machine's hardware) better utilize machine resources. To build a static scheduler for a dynamically scheduled machine, we can use almost the same scheduling algorithm as for statically scheduled machines except that no-op instructions left in the schedule need not be generated explicitly. The matter is discussed further in Section 10.4.7.

that all the potential data dependences are satisfied. Predicated execution should not be used aggressively unless the machine has many more resources than can possibly be used otherwise.

### 10.2.7 A Basic Machine Model

Many machines can be represented using the following simple model. A machine  $M = \{R, T\}$ , consists of:

1. A set of operation types  $T$ , such as loads, stores, arithmetic operations, and so on.
2. A vector  $R = [r_1, r_2, \dots]$  representing hardware resources, where  $r_i$  is the number of units available of the  $i$ th kind of resource. Examples of typical resource types include: memory access units, ALU's, and floating-point functional units.

Each operation has a set of input operands, a set of output operands, and a resource requirement. Associated with each input operand is an input latency indicating when the input value must be available (relative to the start of the operation). Typical input operands have zero latency, meaning that the values are needed immediately, at the clock when the operation is issued. Similarly, associated with each output operand is an output latency, which indicates when the result is available, relative to the start of the operation.

Resource usage for each machine operation type  $t$  is modeled by a two-dimensional *resource-reservation table*,  $RT_t$ . The width of the table is the

number of kinds of resources in the machine, and its length is the duration over which resources are used by the operation. Entry  $RT[i,j]$  is the number of units of the  $j$ th resource used by an operation of type  $t$ ,  $i$  clocks after it is issued. For notational simplicity, we assume  $RT[i,j] = 0$  if  $i$  refers to a non-existent entry in the table (i.e.,  $i$  is greater than the number of clocks it takes to execute the operation). Of course, for any  $t$ ,  $i$ , and  $j$ ,  $RT[i,j]$  must be less than or equal to  $R[j]$ , the number of resources of type  $j$  that the machine has.

Typical machine operations occupy only one unit of resource at the time an operation is issued. Some operations may use more than one functional unit. For example, a multiply-and-add operation may use a multiplier in the first clock and an adder in the second. Some operations, such as a divide, may need to occupy a resource for several clocks. *Fully pipelined* operations are those that can be issued every clock, even though their results are not available until some number of clocks later. We need not model the resources of every stage of a pipeline explicitly; one single unit to represent the first stage will do. Any operation occupying the first stage of a pipeline is guaranteed the right to proceed to subsequent stages in subsequent clocks.

- 1) a = b
- 2) c = d
- 3) b = c
- 4) d = a
- 5) c = d
- 6) a = b

Figure 10.5: A sequence of assignments exhibiting data dependences

## 10.2.8 Exercises for Section 10.2

**Exercise 10.2.1:** The assignments in Fig. 10.5 have certain dependences. For each of the following pairs of statements, classify the dependence as (i) true dependence, (n) antidependence, (Hi) output dependence, or (iv) no dependence (i.e., the instructions can appear in either order):

- a) Statements (1) and (4).
- b) Statements (3) and (5).
- c) Statements (1) and (6).
- d) Statements (3) and (6).
- e) Statements (4) and (6).

**Exercise 10.2.2:** Evaluate the expression  $((u+v) + (w+x)) + (y+z)$  exactly as parenthesized (i.e., do not use the commutative or associative laws to reorder the

additions). Give register-level machine code to provide the maximum possible parallelism.

**Exercise 10.2.3 :** Repeat Exercise 10.2.2 for the following expressions:

a)  $(u + (v + (w + x))^j + (y + z).$

b)  $(u + (v + w)) + (x + (y + z)).$

If instead of maximizing the parallelism, we minimized the number of registers, how many steps would the computation take? How many steps do we save by using maximal parallelism?

**Exercise 10.2.4:** The expression of Exercise 10.2.2 can be executed by the sequence of instructions shown in Fig. 10.6. If we have as much parallelism as we need, how many steps are needed to execute the instructions?

```

1) LD r1, u           // r1 = u
2) LD r2, v           // r2 = v
3) ADD r1, r1, r2     // r1 = r1 + r2
4) LD r2, w           // r2 = w
5) LD r3, x           // r3 = x
6) ADD r2, r2, r3     // r2 = r2 + r3
7) ADD r1, r1, r2     // r1 = r1 + r2
8) LD r2, y           // r2 = y
9) LD r3, z           // r3 = z
10) ADD r2, r2, r3    // r2 = r2 + r3
11) ADD r1, r1, r2    // r1 = r1 + r2

```

Figure 10.6: Minimal-register implementation of an arithmetic expression

! **Exercise 10.2.5:** Translate the code fragment discussed in Example 10.4, using the **CMOVZ** conditional copy instruction of Section 10.2.6. What are the data dependences in your machine code?

## 10.3 Basic-Block Scheduling

We are now ready to start talking about code-scheduling algorithms. We start with the easiest problem: scheduling operations in a basic block consisting of machine instructions. Solving this problem optimally is NP-complete. But in practice, a typical basic block has only a small number of highly constrained operations, so simple scheduling techniques suffice. We shall introduce a simple but highly effective algorithm, called *list scheduling*, for this problem.



### 10.3.1 Data-Dependence Graphs

We represent each basic block of machine instructions by a *data-dependence graph*,  $G = (N, E)$ , having a set of nodes  $N$  representing the operations in the machine instructions in the block and a set of directed edges  $E$  representing the data-dependence constraints among the operations. The nodes and edges of  $G$  are constructed as follows:

1. Each operation  $n$  in  $N$  has a resource-reservation table  $RT_n$ , whose value is simply the resource-reservation table associated with the operation type of  $n$ .
2. Each edge  $e$  in  $E$  is labeled with delay  $d_e$  indicating that the destination node must be issued no earlier than  $d_e$  clocks after the source node is issued. Suppose operation  $n_1$  is followed by operation  $n_2$ , and the same location is accessed by both, with latencies  $l_1$  and  $l_2$  respectively. That is, the location's value is produced  $l_1$  clocks after the first instruction begins, and the value is needed by the second instruction  $l_2$  clocks after that instruction begins (note  $l_1 \geq l_2$  and  $l_2 = 0$  is typical). Then, there is an edge  $n_1 \rightarrow n_2$  in  $E$  labeled with delay  $l_1 - l_2$ .

**Example 10.6:** Consider a simple machine that can execute two operations every clock. The first must be either a branch operation or an ALU operation of the form:

```
OP dst, src1, src2
```

The second must be a load or store operation of the form:

```
LD dst, addr
ST addr, src
```

The load operation (LD) is fully pipelined and takes two clocks. However, a load can be followed immediately by a store ST that writes to the memory location read. All other operations complete in one clock.

Shown in Fig. 10.7 is the dependence graph of an example of a basic block and its resources requirement. We might imagine that **R1** is a stack pointer, used to access data on the stack with offsets such as **0** or **12**. The first instruction loads register **R2**, and the value loaded is not available until two clocks later. This observation explains the label **2** on the edges from the first instruction to the second and fifth instructions, each of which needs the value of **R2**. Similarly, there is a delay of **2** on the edge from the third instruction to the fourth; the value loaded into **R3** is needed by the fourth instruction, and not available until two clocks after the third begins.

Since we do not know how the values of **R1** and **R7** relate, we have to consider the possibility that an address like **8 (R1)** is the same as the address **0 (R7)**. That

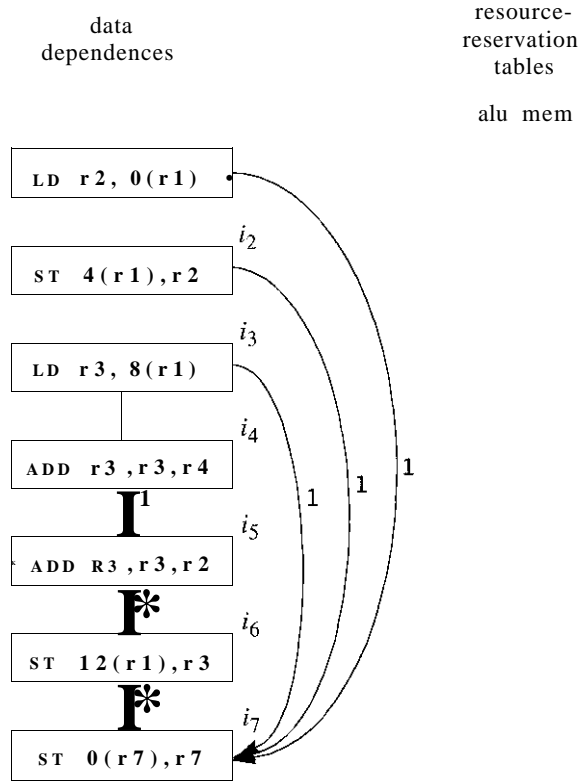

Figure 10.7: Data-dependence graph for Example 10.6

is, the last instruction may be storing into the same address that the third instruction loads from. The machine model we are using allows us to store into a location one clock after we load from that location, even though the value to be loaded will not appear in a register until one clock later. This observation explains the label 1 on the edge from the third instruction to the last. The same reasoning explains the edges and labels from the first instruction to the last. The other edges with label 1 are explained by a dependence or possible dependence conditioned on the value of R7. •

### 10.3.2 List Scheduling of Basic Blocks

The simplest approach to scheduling basic blocks involves visiting each node of the data-dependence graph in "prioritized topological order." Since there can be no cycles in a data-dependence graph, there is always at least one topological order for the nodes. However, among the possible topological orders, some may be preferable to others. We discuss in Section 10.3.3 some of the strategies for

### Pictorial Resource-Reservation Tables

It is frequently useful to visualize a resource-reservation table for an operation by a grid of solid and open squares. Each column corresponds to one of the resources of the machine, and each row corresponds to one of the clocks during which the operation executes. Assuming that the operation never needs more than one unit of any one resource, we may represent 1's by solid squares, and 0's by open squares. In addition, if the operation is fully pipelined, then we only need to indicate the resources used at the first row, and the resource-reservation table becomes a single row.

This representation is used, for instance, in Example 10.6. In Fig. 10.7 we see resource-reservation tables as rows. The two addition operations require the "alu" resource, while the loads and stores require the "mem" resource.

picking a topological order, but for the moment, we just assume that there is some algorithm for picking a preferred order.

The list-scheduling algorithm we shall describe next visits the nodes in the chosen prioritized topological order. The nodes may or may not wind up being scheduled in the same order as they are visited. But the instructions are placed in the schedule as early as possible, so there is a tendency for instructions to be scheduled in approximately the order visited.

In more detail, the algorithm computes the earliest time slot in which each node can be executed, according to its data-dependence constraints with the previously scheduled nodes. Next, the resources needed by the node are checked against a resource-reservation table that collects all the resources committed so far. The node is scheduled in the earliest time slot that has sufficient resources.

**Algorithm 10.7:** List scheduling a basic block.

**INPUT:** A machine-resource vector  $R = [r_1, r_2, \dots]$ , where  $r_k$  is the number of units available of the  $i$ th kind of resource, and a data-dependence graph  $G = (N, E)$ . Each operation  $n$  in  $N$  is labeled with its resource-reservation table  $RT_n$ ; each edge  $e = n_i \rightarrow n_j$  in  $E$  is labeled with  $d_e$  indicating that  $n_j$  must execute no earlier than  $d_e$  clocks after  $n_i$ .

**OUTPUT:** A schedule  $S$  that maps the operations in  $N$  into time slots in which the operations can be initiated satisfying all the data and resources constraints.

**METHOD:** Execute the program in Fig. 10.8. A discussion of what the "prioritized topological order" might be follows in Section 10.3.3. •

```

RT = an empty reservation table;
for (each n in N in prioritized topological order) {
    s =  $\max_{p \rightarrow n} (E\{S\{P\} + d)$ ;
    /* Find the earliest time this instruction could begin,
       given when its predecessors started. */
    while (there exists i such that  $RT[s + \dots + RT[i] > R$ )
        s = s + 1;
        /* Delay the instruction further until the needed
           resources are available. */
    S(n) = s;
    for (all i)
         $RT[s + i] = RT[s + i] + RT[i]$ 
}

```

Figure 10.8: A list scheduling algorithm

### 10.3.3 Prioritized Topological Orders

List scheduling does not backtrack; it schedules each node once and only once. It uses a heuristic priority function to choose among the nodes that are ready to be scheduled next. Here are some observations about possible prioritized orderings of the nodes:

- Without resource constraints, the shortest schedule is given by the *critical path*, the longest path through the data-dependence graph. A metric useful as a priority function is the *height* of the node, which is the length of a longest path in the graph originating from the node.
- On the other hand, if all operations are independent, then the length of the schedule is constrained by the resources available. The critical resource is the one with the largest ratio of uses to the number of units of that resource available. Operations using more critical resources may be given higher priority.
- Finally, we can use the source ordering to break ties between operations; the operation that shows up earlier in the source program should be scheduled first.

**Example 10.8:** For the data-dependence graph in Fig. 10.7, the critical path, including the time to execute the last instruction, is 6 clocks. That is, the critical path is the last five nodes, from the load of R3 to the store of R7. The total of the delays on the edges along this path is 5, to which we add 1 for the clock needed for the last instruction.

Using the height as the priority function, Algorithm 10.7 finds an optimal schedule as shown in Fig. 10.9. Notice that we schedule the load of R3 first, since it has the greatest height. The add of R3 and R4 has the resources to be

schedule	resource- reservation table
	alu mem
	<b>LD R3,8(R1)</b>
	<b>LD R2,0(R1)</b>
<b>ADD R3,R3,R4</b>	
<b>ADD R3,R3,R2</b>	<b>ST 4(R1),R2</b>
	<b>ST 12(R1),R3</b>
	<b>ST 0(R7),R7</b>

Figure 10.9: Result of applying list scheduling to the example in Fig. 10.7

scheduled at the second clock, but the delay of 2 for a load forces us to wait until the third clock to schedule this add. That is, we cannot be sure that R3 will have its needed value until the beginning of clock 3. •

1) LD R1, a	LD R1, a	LD R1, a
2) LD R2, b	LD R2, b	LD R2, b
3) SUB R3, R1, R2	SUB R1, R1, R2	SUB R3, R1, R2
4) ADD R2, R1, R2	ADD R2, R1, R2	ADD R4, R1, R2
5) ST a, R3	ST a, R1	ST a, R3
6) ST b, R2	ST b, R2	ST b, R4
(a)	(b)	(c)

Figure 10.10: Machine code for Exercise 10.3.1

### 10.3.4 Exercises for Section 10.3

**Exercise 10.3.1:** For each of the code fragments of Fig. 10.10, draw the data-dependence graph.

**Exercise 10.3.2:** Assume a machine with one ALU resource (for the ADD and SUB operations) and one MEM resource (for the LD and ST operations). Assume that all operations require one clock, except for the LD, which requires two. However, as in Example 10.6, a ST on the same memory location can commence one clock after a LD on that location commences. Find a shortest schedule for each of the fragments in Fig. 10.10.

Exercise 10.3.3: Repeat Exercise 10.3.2 assuming:

- i.* The machine has one ALU resource and two MEM resources.
- ii.* The machine has two ALU resources and one MEM resource.
- Hi.* The machine has two ALU resources and two MEM resources.

```

1] LD R1, a
   ST b, R1
3; LD R2, c
   ST c, R1
   LD R1, d
6; ST d, R2
7' ST a, R1

```

Figure 10.11: Machine code for Exercise 10.3.4

Exercise 10.3.4: Assuming the machine model of Example 10.6 (as in Exercise 10.3.2):

- a) Draw the data dependence graph for the code of Fig. 10.11.
- b) What are all the critical paths in your graph from part (a)?
- ! c) Assuming unlimited MEM resources, what are all the possible schedules for the seven instructions?

## 10.4 Global Code Scheduling

For a machine with a moderate amount of instruction-level parallelism, schedules created by compacting individual basic blocks tend to leave many resources idle. In order to make better use of machine resources, it is necessary to consider code-generation strategies that move instructions from one basic block to another. Strategies that consider more than one basic block at a time are referred to as *global scheduling* algorithms. To do global scheduling correctly, we must consider not only data dependences but also control dependences. We must ensure that

1. All instructions in the original program are executed in the optimized program, and
2. While the optimized program may execute extra instructions speculatively, these instructions must not have any unwanted side effects.

### 10.4.1 Primitive Code Motion

Let us first study the issues involved in moving operations around by way of a simple example.

Example 10.9: Suppose we have a machine that can execute any two operations in a single clock. Every operation executes with a delay of one clock, except for the load operation, which has a latency of two clocks. For simplicity, we assume that all memory accesses in the example are valid and will hit in the cache. Figure 10.12(a) shows a simple flow graph with three basic blocks. The code is expanded into machine operations in Figure 10.12(b). All the instructions in each basic block must execute serially because of data dependences; in fact, a no-op instruction has to be inserted in every basic block.

Assume that the addresses of variables  $a$ ,  $b$ ,  $c$ ,  $d$ , and  $e$  are distinct and that those addresses are stored in registers  $R1$  through  $R5$ , respectively. The computations from different basic blocks therefore share no data dependences. We observe that all the operations in block  $B_1$  are executed regardless of whether the branch is taken, and can therefore be executed in parallel with operations from block  $B_2$ . We cannot move operations from  $B_2$  down to  $B_3$ , because they are needed to determine the outcome of the branch.

Operations in block  $B_2$  are control-dependent on the test in block  $B_1$ . We can perform the load from  $B_2$  speculatively in block  $B_1$  for free and shave two clocks from the execution time whenever the branch is taken.

Stores should not be performed speculatively because they overwrite the old value in a memory location. It is possible, however, to delay a store operation. We cannot simply place the store operation from block  $B_2$  in block  $B_3$ , because it should only be executed if the flow of control passes through block  $B_2$ . However, we can place the store operation in a duplicated copy of  $B_3$ . Figure 10.12(c) shows such an optimized schedule. The optimized code executes in 4 clocks, which is the same as the time it takes to execute  $B_2$  alone.

•

Example 10.9 shows that it is possible to move operations up and down an execution path. Every pair of basic blocks in this example has a different "dominance relation," and thus the considerations of when and how instructions can be moved between each pair are different. As discussed in Section 9.6.1, a block  $B$  is said to dominate block  $B'$  if every path from the entry of the control-flow graph to  $B'$  goes through  $B$ . Similarly, a block  $B$  *postdominates* block  $B'$  if every path from  $B'$  to the exit of the graph goes through  $B$ . When  $B$  dominates  $B'$  and  $B'$  postdominates  $B$ , we say that  $B$  and  $B'$  are *control equivalent*, meaning that one is executed when and only when the other is. For the example in Fig. 10.12, assuming  $B_1$  is the entry and  $B_3$  the exit,

1.  $B_2$  and  $B_3$  are control equivalent:  $B_2$  dominates  $B_3$  and  $B_3$  postdominates  $B_2$ .
2.  $B_1$  dominates  $B_2$ , but  $B_2$  does not postdominate  $B_1$ , and

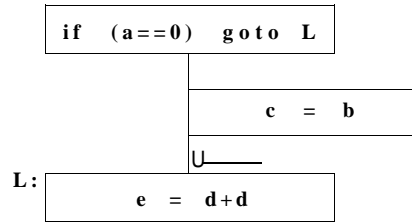

(a) Source program

```

LD R6,0(R1)
nop
BEQZ R6,L

LD R7,0(R2)
nop
ST 0(R3),R7

L: LD R8,0(R4)
nop
ADD R8,R8,R8
ST 0(R5),R8
  
```

(b) Locally scheduled machine code

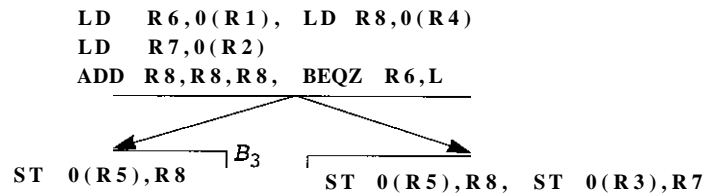

(c) Globally scheduled machine code

Figure 10.12: Flow graphs before and after global scheduling in Example 10.9



3.  $B_i$  does not dominate  $B_j$ , but  $B_j$  postdominates  $B_i$ .

It is also possible for a pair of blocks along a path to share neither a dominance nor postdominance relation.

### 10.4.2 Upward Code Motion

We now examine carefully what it means to move an operation up a path. Suppose we wish to move an operation from block  $src$  up a control-flow path to block  $dst$ . We assume that such a move does not violate any data dependences and that it makes paths through  $dst$  and  $src$  run faster. If  $dst$  dominates  $src$ , and  $src$  postdominates  $dst$ , then the operation moved is executed once and only once, when it should.

#### **If $src$ does not postdominate $dst$**

Then there exists a path that passes through  $dst$  that does not reach  $src$ . An extra operation would have been executed in this case. This code motion is illegal unless the operation moved has no unwanted side effects. If the moved operation executes "for free" (i.e., it uses only resources that otherwise would be idle), then this move has no cost. It is beneficial only if the control flow reaches  $src$ .

#### **If $dst$ does not dominate $src$**

Then there exists a path that reaches  $src$  without first going through  $dst$ . We need to insert copies of the moved operation along such paths. We know how to achieve exactly that from our discussion of partial redundancy elimination in Section 9.5. We place copies of the operation along basic blocks that form a cut set separating the entry block from  $src$ . At each place where the operation is inserted, the following constraints must be satisfied:

1. The operands of the operation must hold the same values as in the original,
2. The result does not overwrite a value that is still needed, and
3. It itself is not subsequently overwritten before reaching  $src$ .

These copies render the original instruction in  $src$  fully redundant, and it thus can be eliminated.

We refer to the extra copies of the operation as *compensation code*. As discussed in Section 9.5, basic blocks can be inserted along critical edges to create places for holding such copies. The compensation code can potentially make some paths run slower. Thus, this code motion improves program execution only if the optimized paths are executed more frequently than the nonoptimized ones.

### 10.4.3 Downward Code Motion

Suppose we are interested in moving an operation from block *src* down a control-flow path to block *dst*. We can reason about such code motion in the same way as above.

**If *src* does not dominate *dst***

Then there exists a path that reaches *dst* without first visiting *src*. Again, an extra operation will be executed in this case. Unfortunately, downward code motion is often applied to writes, which have the side effects of overwriting old values. We can get around this problem by replicating the basic blocks along the paths from *src* to *dst*, and placing the operation only in the new copy of *dst*. Another approach, if available, is to use predicated instructions. We guard the operation moved with the predicate that guards the *src* block. Note that the predicated instruction must be scheduled only in a block dominated by the computation of the predicate, because the predicate would not be available otherwise.

**If *dst* does not postdominate *src***

As in the discussion above, compensation code needs to be inserted so that the operation moved is executed on all paths not visiting *dst*. This transformation is again analogous to partial redundancy elimination, except that the copies are placed below the *src* block in a cut set that separates *src* from the exit.

#### Summary of Upward and Downward Code Motion

From this discussion, we see that there is a range of possible global code motions which vary in terms of benefit, cost, and implementation complexity. Figure 10.13 shows a summary of these various code motions; the lines correspond to the following four cases:

	up: <i>src</i> postdom <i>dst</i>	<i>dst</i> dom <i>src</i>	speculation	compensation
	down: <i>src</i> dom <i>dst</i>	<i>dst</i> postdom <i>src</i>	code dup.	code
1	yes	yes	no	no
2	no	yes	yes	no
3	yes	no	no	yes
4	no	no	yes	yes

Figure 10.13: Summary of code motions

1. Moving instructions between control-equivalent blocks is simplest and most cost effective. No extra operations are ever executed and no compensation code is needed.

2. Extra operations may be executed if the source does not postdominate (dominate) the destination in upward (downward) code motion. This code motion is beneficial if the extra operations can be executed for free, and the path passing through the source block is executed.
3. Compensation code is needed if the destination does not dominate (post-dominate) the source in upward (downward) code motion. The paths with the compensation code may be slowed down, so it is important that the optimized paths are more frequently executed.
4. The last case combines the disadvantages of the second and third case: extra operations may be executed and compensation code is needed.

#### 10.4.4 Updating Data Dependences

As illustrated by Example 10.10 below, code motion can change the data-dependence relations between operations. Thus data dependences must be updated after each code movement.

Example 10.10 : For the flow graph shown in Fig. 10.14, either assignment to  $x$  can be moved up to the top block, since all the dependences in the original program are preserved with this transformation. However, once we have moved one assignment up, we cannot move the other. More specifically, we see that variable  $x$  is not live on exit in the top block before the code motion, but it is live after the motion. If a variable is live at a program point, then we cannot move speculative definitions to the variable above that program point. •

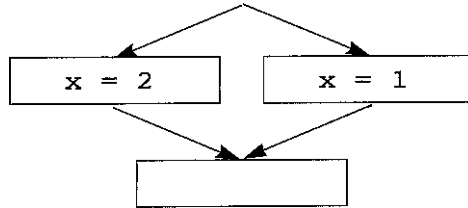

Figure 10.14: Example illustrating the change in data dependences due to code motion.

#### 10.4.5 Global Scheduling Algorithms

We saw in the last section that code motion can benefit some paths while hurting the performance of others. The good news is that instructions are not all created equal. In fact, it is well established that over 90% of a program's execution time is spent on less than 10% of the code. Thus, we should aim to

make the frequently executed paths run faster while possibly making the less frequent paths run slower.

There are a number of techniques a compiler can use to estimate execution frequencies. It is reasonable to assume that instructions in the innermost loops are executed more often than code in outer loops, and that branches that go backward are more likely to be taken than not taken. Also, branch statements found to guard program exits or exception-handling routines are unlikely to be taken. The best frequency estimates, however, come from dynamic profiling. In this technique, programs are instrumented to record the outcomes of conditional branches as they run. The programs are then run on representative inputs to determine how they are likely to behave in general. The results obtained from this technique have been found to be quite accurate. Such information can be fed back to the compiler to use in its optimizations.

#### Region-Based Scheduling

We now describe a straightforward global scheduler that supports the two easiest forms of code motion:

1. Moving operations up to control-equivalent basic blocks, and
2. Moving operations speculatively up one branch to a dominating predecessor.

Recall from Section 9.7.1 that a region is a subset of a control-flow graph that can be reached only through one entry block. We may represent any procedure as a hierarchy of regions. The entire procedure constitutes the top-level region, nested in it are subregions representing the natural loops in the function. We assume that the control-flow graph is reducible.

**Algorithm 10.11:** Region-based scheduling.

**INPUT:** A control-flow graph and a machine-resource description.

**OUTPUT:** A schedule  $S$  mapping each instruction to a basic block and a time slot.

**METHOD:** Execute the program in Fig. 10.15. Some shorthand terminology should be apparent:  $ControlEquiv(B)$  is the set of blocks that are control-equivalent to block  $B$ , and  $DominatedSucc$  applied to a set of blocks is the set of blocks that are successors of at least one block in the set and are dominated by all.

Code scheduling in Algorithm 10.11 proceeds from the innermost regions to the outermost. When scheduling a region, each nested subregion is treated as a black box; instructions are not allowed to move in or out of a subregion. They can, however, move around a subregion, provided their data and control dependences are satisfied.

```

for (each region  $R$  in topological order, so that inner regions
      are processed before outer regions) {
  compute data dependences;
  for (each basic block  $B$  of  $R$  in prioritized topological order) {
     $CandBlocks = ControlEquiv(B) \cup$ 
       $DominatedSucc(ControlEquiv(B));$ 
     $CandInsts$  — ready instructions in  $CandBlocks$ ;
    for ( $t = 0, 1, \dots$  until all instructions from  $B$  are scheduled) {
      for (each instruction  $n$  in  $CandInsts$  in priority order)
        if ( $n$  has no resource conflicts at time  $t$ ) {
           $S(n) = (B, t);$ 
          update resource commitments;
          update data dependences;
        }
      update  $CandInsts$ ;
    }
  }
}

```

Figure 10.15: A region-based global scheduling algorithm

All control and dependence edges flowing back to the header of the region are ignored, so the resulting control-flow and data-dependence graphs are acyclic. The basic blocks in each region are visited in topological order. This ordering guarantees that a basic block is not scheduled until all the instructions it depends on have been scheduled. Instructions to be scheduled in a basic block  $B$  are drawn from all the blocks that are control-equivalent to  $B$  (including  $B$ ), as well as their immediate successors that are dominated by  $B$ .

A list-scheduling algorithm is used to create the schedule for each basic block. The algorithm keeps a list of candidate instructions,  $CandInsts$ , which contains all the instructions in the candidate blocks whose predecessors all have been scheduled. It creates the schedule clock-by-clock. For each clock, it checks each instruction from the  $CandInsts$  in priority order and schedules it in that clock if resources permit. Algorithm 10.11 then updates  $CandInsts$  and repeats the process, until all instructions from  $B$  are scheduled.

The priority order of instructions in  $CandInsts$  uses a priority function similar to that discussed in Section 10.3. We make one important modification, however. We give instructions from blocks that are control equivalent to  $B$  higher priority than those from the successor blocks. The reason is that instructions in the latter category are only speculatively executed in block  $B$ .

•

**Loop Unrolling**

In region-based scheduling, the boundary of a loop iteration is a barrier to code motion. Operations from one iteration cannot overlap with those from another. One simple but highly effective technique to mitigate this problem is to unroll the loop a small number of times before code scheduling. A for-loop such as

```
for (i = 0; i < N; i++) {
    S(i);
}
```

can be written as in Fig. 10.16(a). Similarly, a repeat-loop such as

```
repeat
    S;
until C;
```

can be written as in Fig. 10.16(b). Unrolling creates more instructions in the loop body, permitting global scheduling algorithms to find more parallelism.

```
for (i = 0; i+4 < N; i+=4) {
    S(i);
    S(i+1);
    S(i+2);
    S(i+3);
}
for ( ; i < N; i++) {
    S(i);
}
```

(a) Unrolling a for-loop.

```
repeat {
    S;
    if (C) break;
    S;
    if (C) break;
    S;
    if (C) break;
    S;
} until C;
```

(b) Unrolling a repeat-loop.

Figure 10.16: Unrolled loops

### Neighborhood Compaction

Algorithm 10.11 only supports the first two forms of code motion described in Section 10.4.1. Code motions that require the introduction of compensation code can sometimes be useful. One way to support such code motions is to follow the region-based scheduling with a simple pass. In this pass, we can examine each pair of basic blocks that are executed one after the other, and check if any operation can be moved up or down between them to improve the execution time of those blocks. If such a pair is found, we check if the instruction to be moved needs to be duplicated along other paths. The code motion is made if it results in an expected net gain.

This simple extension can be quite effective in improving the performance of loops. For instance, it can move an operation at the beginning of one iteration to the end of the preceding iteration, while also moving the operation from the first iteration out of the loop. This optimization is particularly attractive for tight loops, which are loops that execute only a few instructions per iteration. However, the impact of this technique is limited by the fact that each code-motion decision is made locally and independently.

### 10.4.6 Advanced Code Motion Techniques

If our target machine is statically scheduled and has plenty of instruction-level parallelism, we may need a more aggressive algorithm. Here is a high-level description of further extensions:

1. To facilitate the extensions below, we can add new basic blocks along control-flow edges originating from blocks with more than one predecessor. These basic blocks will be eliminated at the end of code scheduling if they are empty. A useful heuristic is to move instructions out of a basic block that is nearly empty, so that the block can be eliminated completely.
2. In Algorithm 10.11, the code to be executed in each basic block is scheduled once and for all as each block is visited. This simple approach suffices because the algorithm can only move operations up to dominating blocks. To allow motions that require the addition of compensation code, we take a slightly different approach. When we visit block  $B$ , we only schedule instructions from  $B$  and all its control-equivalent blocks. We first try to place these instructions in predecessor blocks, which have already been visited and for which a partial schedule already exists. We try to find a destination block that would lead to an improvement on a frequently executed path and then place copies of the instruction on other paths to guarantee correctness. If the instructions cannot be moved up, they are scheduled in the current basic block as before.
3. Implementing downward code motion is harder in an algorithm that visits basic blocks in topological order, since the target blocks have yet to be

scheduled. However, there are relatively fewer opportunities for such code motion anyway. We move all operations that

- (a) can be moved, and
- (b) cannot be executed for free in their native block.

This simple strategy works well if the target machine is rich with many unused hardware resources.

### 10.4.7 Interaction with Dynamic Schedulers

A dynamic scheduler has the advantage that it can create new schedules according to the run-time conditions, without having to encode all these possible schedules ahead of time. If a target machine has a dynamic scheduler, the static scheduler's primary function is to ensure that instructions with high latency are fetched early so that the dynamic scheduler can issue them as early as possible.

Cache misses are a class of unpredictable events that can make a big difference to the performance of a program. If data-prefetch instructions are available, the static scheduler can help the dynamic scheduler significantly by placing these prefetch instructions early enough that the data will be in the cache by the time they are needed. If prefetch instructions are not available, it is useful for a compiler to estimate which operations are likely to miss and try to issue them early.

If dynamic scheduling is not available on the target machine, the static scheduler must be conservative and separate every data-dependent pair of operations by the minimum delay. If dynamic scheduling is available, however, the compiler only needs to place the data-dependent operations in the correct order to ensure program correctness. For best performance, the compiler should assign long delays to dependences that are likely to occur and short ones to those that are not likely.

Branch misprediction is an important cause of loss in performance. Because of the long misprediction penalty, instructions on rarely executed paths can still have a significant effect on the total execution time. Higher priority should be given to such instructions to reduce the cost of misprediction.

### 10.4.8 Exercises for Section 10.4

Exercise 10.4.1: Show how to unroll the generic while-loop

```
while (C)
    S;
```

! Exercise 10.4.2: Consider the code fragment:

```
if (x == 0) a = b;
else a = c;
d = a;
```



Assume a machine that uses the delay model of Example 10.6 (loads take two clocks, all other instructions take one clock). Also assume that the machine can execute any two instructions at once. Find a shortest possible execution of this fragment. Do not forget to consider which register is best used for each of the copy steps. Also, remember to exploit the information given by register descriptors as was described in Section 8.6, to avoid unnecessary loads and stores.

## 10.5 Software Pipelining

As discussed in the introduction of this chapter, numerical applications tend to have much parallelism. In particular, they often have loops whose iterations are completely independent of one another. These loops, known as *do-all* loops, are particularly attractive from a parallelization perspective because their iterations can be executed in parallel to achieve a speed-up linear in the number of iterations in the loop. Do-all loops with many iterations have enough parallelism to saturate all the resources on a processor. It is up to the scheduler to take full advantage of the available parallelism. This section describes an algorithm known as *software pipelining*, that schedules an entire loop at a time, taking full advantage of the parallelism across iterations.

### 10.5.1 Introduction

We shall use the do-all loop in Example 10.12 throughout this section to explain software pipelining. We first show that scheduling across iterations is of great importance, because there is relatively little parallelism among operations in a single iteration. Next, we show that loop unrolling improves performance by overlapping the computation of unrolled iterations. However, the boundary of the unrolled loop still poses as a barrier to code motion, and unrolling still leaves a lot of performance "on the table." The technique of software pipelining, on the other hand, overlaps a number of consecutive iterations continually until it runs out of iterations. This technique allows software pipelining to produce highly efficient and compact code.

Example 10.12 : Here is a typical do-all loop:

```
for (i = 0; i < n; i++)
    D[i] = A[i]*B[i] + c;
```

Iterations in the above loop write to different memory locations, which are themselves distinct from any of the locations read. Therefore, there are no memory dependences between the iterations, and all iterations can proceed in parallel.

We adopt the following model as our target machine throughout this section. In this model

- The machine can issue in a single clock: one load, one store, one arithmetic operation, and one branch operation.
- The machine has a loop-back operation of the form

```
BL R, L
```

which decrements register  $R$  and, unless the result is 0, branches to location  $L$ .

- Memory operations have an auto-increment addressing mode, denoted by ++ after the register. The register is automatically incremented to point to the next consecutive address after each access.
- The arithmetic operations are fully pipelined; they can be initiated every clock but their results are not available until 2 clocks later. All other instructions have a single-clock latency.

If iterations are scheduled one at a time, the best schedule we can get on our machine model is shown in Fig. 10.17. Some assumptions about the layout of the data also also indicated in that figure: registers **R1**, **R2**, and **R3** hold the addresses of the beginnings of arrays  $A$ ,  $B$ , and  $D$ , register **R4** holds the constant  $c$ , and register **R10** holds the value  $n - 1$ , which has been computed outside the loop. The computation is mostly serial, taking a total of 7 clocks; only the loop-back instruction is overlapped with the last operation in the iteration. •

```
// R1, R2, R3 = &A, &B, &D
// R4          = c
// R10         = n-1

L: LD R5, 0(R1++)
   LD R6, 0(R2++)
   MUL R7, R5, R6
   nop
   ADD R8, R7, R4
   nop
   ST 0(R3++), R8      BL R10, L
```

Figure 10.17: Locally scheduled code for Example 10.12

In general, we get better hardware utilization by unrolling several iterations of a loop. However, doing so also increases the code size, which in turn can have a negative impact on overall performance. Thus, we have to compromise, picking a number of times to unroll a loop that gets most of the performance improvement, yet doesn't expand the code too much. The next example illustrates the tradeoff.

Example 10.13: While hardly any parallelism can be found in each iteration of the loop in Example 10.12, there is plenty of parallelism across the iterations. Loop unrolling places several iterations of the loop in one large basic block, and a simple list-scheduling algorithm can be used to schedule the operations to execute in parallel. If we unroll the loop in our example four times and apply Algorithm 10.7 to the code, we can get the schedule shown in Fig. 10.18. (For simplicity, we ignore the details of register allocation for now). The loop executes in 13 clocks, or one iteration every 3.25 clocks.

A loop unrolled  $k$  times takes at least  $2k + 5$  clocks, achieving a throughput of one iteration every  $2 + 5/k$  clocks. Thus, the more iterations we unroll, the faster the loop runs. As  $n \rightarrow \infty$ , a fully unrolled loop can execute on average an iteration every two clocks. However, the more iterations we unroll, the larger the code gets. We certainly cannot afford to unroll all the iterations in a loop. Unrolling the loop 4 times produces code with 13 instructions, or 163% of the optimum; unrolling the loop 8 times produces code with 21 instructions, or 131% of the optimum. Conversely, if we wish to operate at, say, only 110% of the optimum, we need to unroll the loop 25 times, which would result in code with 55 instructions. •

## 10.5.2 Software Pipelining of Loops

Software pipelining provides a convenient way of getting optimal resource usage and compact code at the same time. Let us illustrate the idea with our running example.

Example 10.14: In Fig. 10.19 is the code from Example 10.12 unrolled five times. (Again we leave out the consideration of register usage.) Shown in row  $i$  are all the operations issued at clock  $i$ ; shown in column  $j$  are all the operations from iteration  $j$ . Note that every iteration has the same schedule relative to its beginning, and also note that every iteration is initiated two clocks after the preceding one. It is easy to see that this schedule satisfies all the resource and data-dependence constraints.

We observe that the operations executed at clocks 7 and 8 are the same as those executed at clocks 9 and 10. Clocks 7 and 8 execute operations from the first four iterations in the original program. Clocks 9 and 10 also execute operations from four iterations, this time from iterations 2 to 5. In fact, we can keep executing this same pair of multi-operation instructions to get the effect of retiring the oldest iteration and adding a new one, until we run out of iterations.

Such dynamic behavior can be encoded succinctly with the code shown in Fig. 10.20, if we assume that the loop has at least 4 iterations. Each row in the figure corresponds to one machine instruction. Lines 7 and 8 form a 2-clock loop, which is executed  $n - 3$  times, where  $n$  is the number of iterations in the original loop. •

```

L:  LD
    LD
        LD
    MUL LD
        MUL LD
    ADD  LD
        ADD  LD
    ST   MUL LD
        ST   MUL
            ADD
                ADD
                    ST
                        ST   BL (L)
    
```

Figure 10.18: Unrolled code for Example 10.12

Clock	$3 = I$	$J = 2$	$i = 3$	$i = 4$	$j =$
1	LD				
2	LD				
3	MUL	LD			
4		LD			
5		MUL	LD		
6	ADD		LD		
7			MUL	LD	
8	ST	ADD		LD	
9				MUL	LD
10		ST	ADD		LD
11					MUL
12			ST	ADD	
13					
14				ST	ADD
15					
16					ST

Figure 10.19: Five unrolled iterations of the code in Example 10.12

```

1)      LD
2)      LD
3)      MUL  LD
4)              LD
5)              MUL  LD
6)      ADD              LD
7)  L:              MUL  LD
8)      ST  ADD              LD  BL (L)
9)              MUL
10)             ST  ADD
11)
12)             ST  ADD
13)
14)             ST

```

Figure 10.20: Software-pipelined code for Example 10.12

The technique described above is called *software pipelining*, because it is the software analog of a technique used for scheduling hardware pipelines. We can think of the schedule executed by each iteration in this example as an 8-stage pipeline. A new iteration can be started on the pipeline every 2 clocks. At the beginning, there is only one iteration in the pipeline. As the first iteration proceeds to stage three, the second iteration starts to execute in the first pipeline stage.

By clock 7, the pipeline is fully filled with the first four iterations. In the steady state, four consecutive iterations are executing at the same time. A new iteration is started as the oldest iteration in the pipeline retires. When we run out of iterations, the pipeline drains, and all the iterations in the pipeline run to completion. The sequence of instructions used to fill the pipeline, lines 1 through 6 in our example, is called the *prolog*; lines 7 and 8 are the *steady state*; and the sequence of instructions used to drain the pipeline, lines 9 through 14, is called the *epilog*.

For this example, we know that the loop cannot be run at a rate faster than 2 clocks per iteration, since the machine can only issue one read every clock, and there are two reads in each iteration. The software-pipelined loop above executes in  $2n + 6$  clocks, where  $n$  is the number of iterations in the original loop. As  $n \rightarrow \infty$ , the throughput of the loop approaches the rate of one iteration every two clocks. Thus, software scheduling, unlike unrolling, can potentially encode the optimal schedule with a very compact code sequence.

Note that the schedule adopted for each individual iteration is not the shortest possible. Comparison with the locally optimized schedule shown in Fig. 10.17 shows that a delay is introduced before the **ADD** operation. The delay is placed strategically so that the schedule can be initiated every two clocks without resource conflicts. Had we stuck with the locally compacted schedule,

the initiation interval would have to be lengthened to 4 clocks to avoid resource conflicts, and the throughput rate would be halved. This example illustrates an important principle in pipeline scheduling: the schedule must be chosen carefully in order to optimize the throughput. A locally compacted schedule, while minimizing the time to complete an iteration, may result in suboptimal throughput when pipelined.

### 10.5.3 Register Allocation and Code Generation

Let us begin by discussing register allocation for the software-pipelined loop in Example 10.14.

**Example 10.15:** In Example 10.14, the result of the multiply operation in the first iteration is produced at clock 3 and used at clock 6. Between these clock cycles, a new result is generated by the multiply operation in the second iteration at clock 5; this value is used at clock 8. The results from these two iterations must be held in different registers to prevent them from interfering with each other. Since interference occurs only between adjacent pairs of iterations, it can be avoided with the use of two registers, one for the odd iterations and one for the even iterations. Since the code for odd iterations is different from that for the even iterations, the size of the steady-state loop is doubled. This code can be used to execute any loop that has an odd number of iterations greater than or equal to 5.

```

if (N >= 5)
    N2 = 3 + 2 * floor((N-3)/2);
else
    N2 = 0;
for (i = 0; i < N2; i++)
    D[i] = A[i]* B[i] + c;
for (i = N2; i < N; i++)
    D[i] = A[i]* B[i] + c;

```

Figure 10.21: Source-level unrolling of the loop from Example 10.12

To handle loops that have fewer than 5 iterations and loops with an even number of iterations, we generate the code whose source-level equivalent is shown in Fig. 10.21. The first loop is pipelined, as seen in the machine-level equivalent of Fig. 10.22. The second loop of Fig. 10.21 need not be optimized, since it can iterate at most four times. •

### 10.5.4 Do-Across Loops

Software pipelining can also be applied to loops whose iterations share data dependences. Such loops are known as *do-across loops*.

```

1.      LD R5,0(R1++)
2.      LD R6,0(R2++)
3.      LD R5,0(R1++)  MUL R7,R5,R6
4.      LD R6,0(R2++)
5.      LD R5,0(R1++)  MUL R9,R5,R6
6.      LD R6,0(R2++)  ADD R8,R7,R4
7.  L:  LD R5,0(R1++)  MUL R7,R5,R6
8.      LD R6,0(R2++)  ADD R8,R9,R4  ST 0(R3++),R8
9.      LD R5,0(R1++)  MUL R9,R5,R6
10.     LD R6,0(R2++)  ADD R8,R7,R4  ST 0(R3++),R8  BL R10,L
11.                                     MUL R7,R5,R6
12.                                     ADD R8,R9,R4  ST 0(R3++),R8
13.
14.                                     ADD R8,R7,R4  ST 0(R3++),R8
15.
16.                                     ST 0(R3++),R8

```

Figure 10.22: Code after software pipelining and register allocation in Example 10.15

Example 10.16: The code

```

for (i = 0; i < n; i++) {
    sum = sum + A[i];
    B[i] = A[i] * b;
}

```

has a data dependence between consecutive iterations, because the previous value of `sum` is added to `A[i]` to create a new value of `sum`. It is possible to execute the summation in  $O(\log n)$  time if the machine can deliver sufficient parallelism, but for the sake of this discussion, we simply assume that all the sequential dependences must be obeyed, and that the additions must be performed in the original sequential order. Because our assumed machine model takes two clocks to complete an `ADD`, the loop cannot execute faster than one iteration every two clocks. Giving the machine more adders or multipliers will not make this loop run any faster. The throughput of do-across loops like this one is limited by the chain of dependences across iterations.

The best locally compacted schedule for each iteration is shown in Fig. 10.23(a), and the software-pipelined code is in Fig. 10.23(b). This software-pipelined loop starts an iteration every two clocks, and thus operates at the optimal rate. •

```

// R1 = &A; R2 = &B
// R3 = sum
// R4 = b
// RIO = n-1

L: LD R5, 0(R1++)
   MUL R6, R5, R4
   ADD R3, R3, R4
   ST R6, 0(R2++)          BL RIO, L

```

(a) The best locally compacted schedule.

```

// R1 = &A; R2 = &B
// R3 = sum
// R4 = b
// RIO = n-2

LD R5, 0(R1++)
MUL R6, R5, R4
L: ADD R3, R3, R4          LD R5, 0(R1++)
   ST R6, 0(R2++)        MUL R6, R5, R4 BL RIO, L
                           ADD R3, R3, R4
                           ST R6, 0(R2++)

```

(b) The software-pipelined version.

Figure 10.23: Software-pipelining of a do-across loop

### 10.5.5 Goals and Constraints of Software Pipelining

The primary goal of software pipelining is to maximize the throughput of a long-running loop. A secondary goal is to keep the size of the code generated reasonably small. In other words, the software-pipelined loop should have a small steady state of the pipeline. We can achieve a small steady state by requiring that the relative schedule of each iteration be the same, and that the iterations be initiated at a constant interval. Since the throughput of the loop is simply the inverse of the initiation interval, the objective of software pipelining is to minimize this interval.

A software-pipeline schedule for a data-dependence graph  $G = (N, E)$  can be specified by

1. An initiation interval  $T$  and
2. A relative schedule  $S$  that specifies, for each operation, when that operation is executed relative to the start of the iteration to which it belongs.



Thus, an operation  $n$  in the  $i$ th iteration, counting from 0, is executed at clock  $i \times T + S(n)$ . Like all the other scheduling problems, software pipelining has two kinds of constraints: resources and data dependences. We discuss each kind in detail below.

#### Modular Resource Reservation

Let a machine's resources be represented by  $R = [r_1, r_2, \dots]$ , where  $r_i$  is the number of units of the  $i$ th kind of resource available. If an iteration of a loop requires  $n_i$  units of resource  $i$ , then the average initiation interval of a pipelined loop is at least  $\max_i(r_i/n_i)$  clock cycles. Software pipelining requires that the initiation intervals between any pair of iterations have a constant value. Thus, the initiation interval must have at least  $\lceil \max_i(r_i/n_i) \rceil$  clocks. If  $\max_i(r_i/n_i)$  is less than 1, it is useful to unroll the source code a small number of times.

Example 10.17: Let us return to our software-pipelined loop shown in Fig. 10.20. Recall that the target machine can issue one load, one arithmetic operation, one store, and one loop-back branch per clock. Since the loop has two loads, two arithmetic operations, and one store operation, the minimum initiation interval based on resource constraints is 2 clocks.

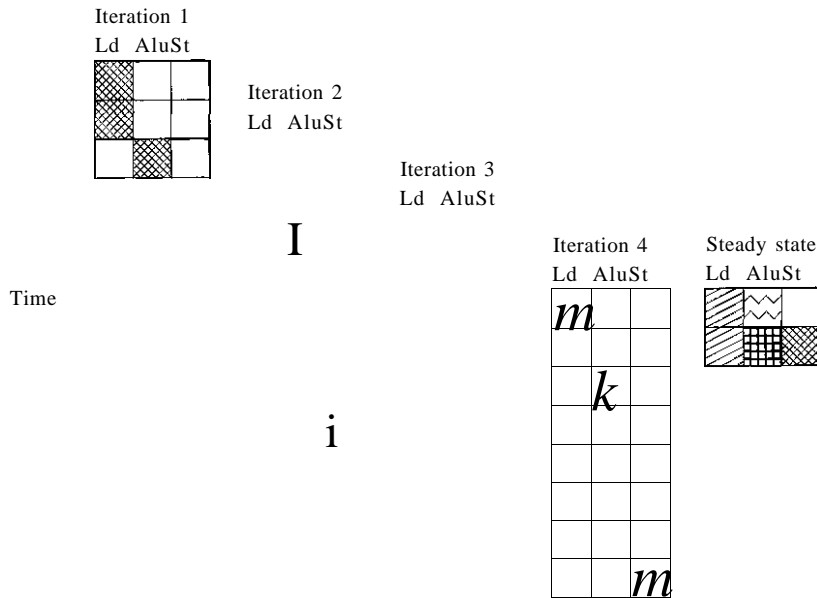

Figure 10.24: Resource requirements of four consecutive iterations from the code in Example 10.13

Figure 10.24 shows the resource requirements of four consecutive iterations across time. More resources are used as more iterations get initiated, culmi-

nating in maximum resource commitment in the steady state. Let  $RT$  be the resource-reservation table representing the commitment of one iteration, and let  $RT_s$  represent the commitment of the steady state.  $RT_s$  combines the commitment from four consecutive iterations started  $T$  clocks apart. The commitment of row 0 in the table  $RT_s$  corresponds to the sum of the resources committed in  $RT[0]$ ,  $RT[2]$ ,  $RT[4]$ , and  $RT[6]$ . Similarly, the commitment of row 1 in the table corresponds to the sum of the resources committed in  $RT[1]$ ,  $RT[3]$ ,  $RT[5]$ , and  $RT[7]$ . That is, the resources committed in the  $i$ th row in the steady state are given by

$$RT_s[i] = \sum_{\{t \mid (t \bmod T) = i\}} RT[t]$$

We refer to the resource-reservation table representing the steady state as the *modular resource-reservation table* of the pipelined loop.

To check if the software-pipeline schedule has any resource conflicts, we can simply check the commitment of the modular resource-reservation table. Surely, if the commitment in the steady state can be satisfied, so can the commitments in the prolog and epilog, the portions of code before and after the steady-state loop. •

In general, given an initiation interval  $T$  and a resource-reservation table of an iteration  $RT$ , the pipelined schedule has no resource conflicts on a machine with resource vector  $R$  if and only if  $RT_s[i] \leq R$  for all  $i = 0, 1, \dots, T - 1$ .

#### Data-Dependence Constraints

Data dependences in software pipelining are different from those we have encountered so far because they can form cycles. An operation may depend on the result of the same operation from a previous iteration. It is no longer adequate to label a dependence edge by just the delay; we also need to distinguish between instances of the same operation in different iterations. We label a dependence edge  $n_i \rightarrow n_j$  with label  $(\delta, d)$  if operation  $n_j$  in iteration  $i$  must be delayed by at least  $d$  clocks after the execution of operation  $n_i$  in iteration  $i - \delta$ . Let  $S$ , a function from the nodes of the data-dependence graph to integers, be the software pipeline schedule, and let  $T$  be the initiation interval target. Then

$$(S(n_j) - S(n_i)) \geq d + \delta T$$

The iteration difference,  $\delta$ , must be nonnegative. Moreover, given a cycle of data-dependence edges, at least one of the edges has a positive iteration difference.

Example 10.18: Consider the following loop, and suppose we do not know the values of  $p$  and  $q$ :

```
for (i = 0; i < n; i++)
    *(p++) = *(q++) + c;
```

We must assume that any pair of  $*(p++)$  and  $*(q++)$  accesses may refer to the same memory location. Thus, all the reads and writes must execute in the original sequential order. Assuming that the target machine has the same characteristics as that described in Example 10.13, the data-dependence edges for this code are as shown in Fig. 10.25. Note, however, that we ignore the loop-control instructions that would have to be present, either computing and testing  $i$ , or doing the test based on the value of R1 or R2. •

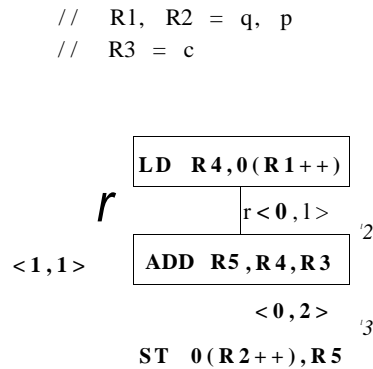

Figure 10.25: Data-dependence graph for Example 10.18

The iteration difference between related operations can be greater than one, as shown in the following example:

```

for (i = 2; i < n; i++)
    A[i] = B[i] + A[i-2]

```

Here the value written in iteration  $i$  is used two iterations later. The dependence edge between the store of  $A[i]$  and the load of  $A[i - 2]$  thus has a difference of 2 iterations.

The presence of data-dependence cycles in a loop imposes yet another limit on its execution throughput. For example, the data-dependence cycle in Fig. 10.25 imposes a delay of 4 clock ticks between load operations from consecutive iterations. That is, loops cannot execute at a rate faster than one iteration every 4 clocks.

The initiation interval of a pipelined loop is no smaller than

$$\max_{c \text{ a cycle in } G} \frac{Y_{\text{in } c} \text{ de}}{X_{\text{in } c} \wedge'}$$

clocks.

In summary, the initiation interval of each software-pipelined loop is bounded by the resource usage in each iteration. Namely, the initiation interval must be no smaller than the ratio of units needed of each resource and the units

available on the machine. In addition, if the loops have data-dependence cycles, then the initiation interval is further constrained by the sum of the delays in the cycle divided by the sum of the iteration differences. The largest of these quantities defines a lower bound on the initiation interval.

### 10.5.6 A Software-Pipelining Algorithm

The goal of software pipelining is to find a schedule with the smallest possible initiation interval. The problem is NP-complete, and can be formulated as an integer-linear-programming problem. We have shown that if we know what the minimum initiation interval is, the scheduling algorithm can avoid resource conflicts by using the modular resource-reservation table in placing each operation. But we do not know what the minimum initiation interval is until we can find a schedule. How do we resolve this circularity?

We know that the initiation interval must be greater than the bound computed from a loop's resource requirement and dependence cycles as discussed above. If we can find a schedule meeting this bound, we have found the optimal schedule. If we fail to find such a schedule, we can try again with larger initiation intervals until a schedule is found. Note that if heuristics, rather than exhaustive search, are used, this process may not find the optimal schedule.

Whether we can find a schedule near the lower bound depends on properties of the data-dependence graph and the architecture of the target machine. We can easily find the optimal schedule if the dependence graph is acyclic and if every machine instruction needs only one unit of one resource. It is also easy to find a schedule close to the lower bound if there are more hardware resources than can be used by graphs with dependence cycles. For such cases, it is advisable to start with the lower bound as the initial initiation-interval target, then keep increasing the target by just one clock with each scheduling attempt. Another possibility is to find the initiation interval using a binary search. We can use as an upper bound on the initiation interval the length of the schedule for one iteration produced by list scheduling.

### 10.5.7 Scheduling Acyclic Data-Dependence Graphs

For simplicity, we assume for now that the loop to be software pipelined contains only one basic block. This assumption will be relaxed in Section 10.5.11.

Algorithm 10.19: Software pipelining an acyclic dependence graph.

**INPUT:** A machine-resource vector  $R = [n, r_1, \dots]$ , where  $n$  is the number of units available of the  $i$ th kind of resource, and a data-dependence graph  $G = (N, E)$ . Each operation  $n$  in  $N$  is labeled with its resource-reservation table  $RT_n$ ; each edge  $e = m \rightarrow n_2$  in  $E$  is labeled with  $\{S, d\}$  indicating that  $n_2$  must execute no earlier than  $d$  clocks after node  $n_1$  from the  $S$ th preceding iteration.

**OUTPUT:** A software-pipelined schedule  $S$  and an initiation interval  $T$ .

**METHOD:** Execute the program in Fig. 10.26. •

```

main() {
    IQ = max $\frac{r_j}{j}$ 
    for (T = To, To + 1, ... , until all nodes in N are scheduled) {
        RT = an empty reservation table with T rows;
        for (each n in N in prioritized topological order) {
            s0 = maxi pi, in E(S(P) + d);
            for (s = s0, s0 + 1, ••• , s0 + T - 1)
                if (NodeScheduled(RT, T, n, s) break;
            if (n cannot be scheduled in RT) break;
        }
    }
}

NodeScheduled(RT, T, n, s) {
    RT' = RT;
    for (each row i in RT)
        RT'[(s + i) mod T] = i2T'[(s + i) mod T] + RT[i];
    if (for all H, ET'(<<) < R) {
        RT = iRT';
        S(n) = s;
        return true;
    }
    else return false;
}

```

Figure 10.26: Software-pipelining algorithm for acyclic graphs

Algorithm 10.19 software pipelines acyclic data-dependence graphs. The algorithm first finds a bound on the initiation interval,  $T_0$ , based on the resource requirements of the operations in the graph. It then attempts to find a software-pipelined schedule starting with  $T_0$  as the target initiation interval. The algorithm repeats with increasingly larger initiation intervals if it fails to find a schedule.

The algorithm uses a list-scheduling approach in each attempt. It uses a modular resource-reservation  $RT$  to keep track of the resource commitment in the steady state. Operations are scheduled in topological order so that the data dependences can always be satisfied by delaying operations. To schedule an operation, it first finds a lower bound so according to the data-dependence constraints. It then invokes *NodeScheduled* to check for possible resource conflicts in the steady state. If there is a resource conflict, the algorithm tries to schedule the operation in the next clock. If the operation is found to conflict for

$T$  consecutive clocks, because of the modular nature of resource-conflict detection, further attempts are guaranteed to be futile. At that point, the algorithm considers the attempt a failure, and another initiation interval is tried.

The heuristics of scheduling operations as soon as possible tends to minimize the length of the schedule for an iteration. Scheduling an instruction as early as possible, however, can lengthen the lifetimes of some variables. For example, loads of data tend to be scheduled early, sometimes long before they are used. One simple heuristic is to schedule the dependence graph backwards because there are usually more loads than stores.

### 10.5.8 Scheduling Cyclic Dependence Graphs

Dependence cycles complicate software pipelining significantly. When scheduling operations in an acyclic graph in topological order, data dependences with scheduled operations can impose only a lower bound on the placement of each operation. As a result, it is always possible to satisfy the data-dependence constraints by delaying operations. The concept of "topological order" does not apply to cyclic graphs. In fact, given a pair of operations sharing a cycle, placing one operation will impose both a lower and upper bound on the placement of the second.

Let  $n_i$  and  $n_j$  be two operations in a dependence cycle,  $S$  be a software-pipeline schedule, and  $T$  be the initiation interval for the schedule. A dependence edge  $n_i \rightarrow n_j$  with label  $(d_i, d_i)$  imposes the following constraint on  $S(n_i)$  and  $S(n_j)$ :

$$(S(n_i) - xT) + S(n_j) - S(n_i) > d_i.$$

Similarly, a dependence edge  $(n_i, n_j)$  with label  $(d_j, d_j)$  imposes constraint

$$(S(n_j) - xT) + S(n_i) - S(n_j) > d_j.$$

Thus

$$S(n_i) + d_j - (d_i \times T) < S(n_j) < S(n_i) - d_i + (d_j \times T).$$

A *strongly connected component* (SCC) in a graph is a set of nodes where every node in the component can be reached by every other node in the component. Scheduling one node in an SCC will bound the time of every other node in the component both from above and from below. Transitively, if there exists a path  $p$  leading from  $n_1$  to  $n_2$ , then

$$S(n_2) - S(n_1) \geq \sum_{e \text{ in } p} (d_e - (\delta_e \times T)) \tag{10.1}$$

Observe that

- Around any cycle, the sum of the  $S$ 's must be positive. If it were 0 or negative, then it would say that an operation in the cycle either had to precede itself or be executed at the same clock for all iterations.
- The schedule of operations within an iteration is the same for all iterations; that requirement is essentially the meaning of a "software pipeline." As a result, the sum of the delays (second components of edge labels in a data-dependence graph) around a cycle is a lower bound on the initiation interval  $T$ .

When we combine these two points, we see that for any feasible initiation interval  $T$ , the value of the right side of Equation (10.1) must be negative or zero. As a result, the strongest constraints on the placement of nodes is obtained from the *simple* paths — those paths that contain no cycles.

Thus, for each feasible  $T$ , computing the transitive effect of data dependences on each pair of nodes is equivalent to finding the length of the longest simple path from the first node to the second. Moreover, since cycles cannot increase the length of a path, we can use a simple dynamic-programming algorithm to find the longest paths without the "simple-path" requirement, and be sure that the resulting lengths will also be the lengths of the longest simple paths (see Exercise 10.5.7).

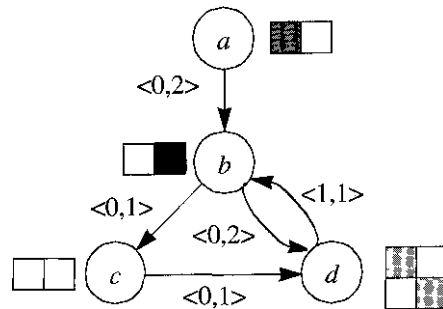

Figure 10.27: Dependence graph and resource requirement in Example 10.20

Example 10.20 : Figure 10.27 shows a data-dependence graph with four nodes  $a, b, c, d$ . Attached to each node is its resource-reservation table; attached to each edge is its iteration difference and delay. Assume for this example that the target machine has one unit of each kind of resource. Since there are three uses of the first resource and two of the second, the initiation interval must be no less than 3 clocks. There are two SCC's in this graph: the first is a trivial component consisting of the node  $a$  alone, and the second consists of nodes  $b, c$ , and  $d$ . The longest cycle,  $b, c, d, b$ , has a total delay of 3 clocks connecting nodes that are 1 iteration apart. Thus, the lower bound on the initiation interval provided by data-dependence cycle constraints is also 3 clocks.

Placing any of 6, c, or  $d$  in a schedule constrains all the other nodes in the component. Let  $T$  be the initiation interval. Figure 10.28 shows the transitive dependences. Part (a) shows the delay and the iteration difference 5, for each edge. The delay is represented directly, but  $S$  is represented by "adding" to the delay the value  $-ST$ .

Figure 10.28(b) shows the length of the longest simple path between two nodes, when such a path exists; its entries are the sums of the expressions given by Fig. 10.28(a), for each edge along the path. Then, in (c) and (d), we see the expressions of (b) with the two relevant values of  $T$ , that is, 3 and 4, substituted for  $T$ . The difference between the schedule of two nodes  $S(n_i) - 5(n_i)$  must be no less than the value given in entry  $(n_i, n_j)$  in each of the tables (c) or (d), depending on the value of  $T$  chosen.

For instance, consider the entry in Fig. 10.28 for the longest (simple) path from c to 6, which is  $2 - T$ . The longest simple path from c to  $b$  is  $c \rightarrow d \rightarrow b$ . The total delay is 2 along this path, and the sum of the 5's is 1, representing the fact that the iteration number must increase by 1. Since  $T$  is the time by which each iteration follows the previous, the clock at which  $b$  must be scheduled is at least  $2 - T$  clocks *after* the clock at which c is scheduled. Since  $T$  is at least 3, we are really saying that  $b$  may be scheduled  $T - 2$  clocks *before* c, or later than that clock, but not earlier.

Notice that considering nonsimple paths from c to  $b$  does not produce a stronger constraint. We can add to the path  $c \rightarrow d \rightarrow b$  any number of iterations of the cycle involving  $d$  and  $b$ . If we add  $k$  such cycles, we get a path length of  $2 - T + k(3 - T)$ , since the total delay along the path is 3, and the sum of the 5's is 1. Since  $T > 3$ , this length can never exceed  $2 - T$ ; i.e., the strongest lower bound on the clock of  $b$  relative to the clock of c is  $2 - T$ , the bound we get by considering the longest simple path.

For example, from entries (6, c) and (c, 6), we see that

$$\begin{aligned} S(c) - S(b) &> 1 \\ 5(6) - 5(c) &> 2 - T. \end{aligned}$$

That is,

$$S(b) + 1 < 5(c) < S(b) - 2 + T.$$

If  $T = 3$ ,

$$5(6) + 1 < 5(c) < 5(6) + 1.$$

Put equivalently, c must be scheduled one clock after 6. If  $T = 4$ , however,

$$5(6) + 1 < 5(c) < 5(6) + 2.$$

That is, c is scheduled one or two clocks after 6.

Given the all-points longest path information, we can easily compute the range where it is legal to place a node due to data dependences. We see that there is no slack in the case when  $T = 3$ , and the slack increases as  $T$  increases.

•



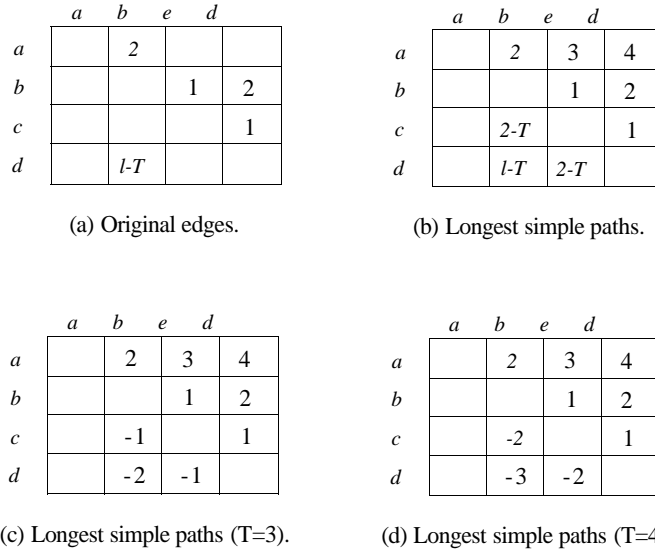

Figure 10.28: Transitive dependences in Example 10.20

Algorithm 10.21: Software pipelining.

**INPUT:** A machine-resource vector  $R = [r_1, r_2, \dots]$ , where  $r_i$  is the number of units available of the  $i$ th kind of resource, and a data-dependence graph  $G = (N, E)$ . Each operation  $n$  in  $N$  is labeled with its resource-reservation table  $RT_n$ . Each edge  $e = n_1 \rightarrow n_2$  in  $E$  is labeled with  $(S, d)$  indicating that  $n_2$  must execute no earlier than  $d$  clocks after node  $n_1$  from the  $S$ th preceding iteration.

**OUTPUT:** A software-pipelined schedule  $S$  and an initiation interval  $T$ .

**METHOD:** Execute the program in Fig. 10.29. •

Algorithm 10.21 has a high-level structure similar to that of Algorithm 10.19, which only handles acyclic graphs. The minimum initiation interval in this case is bounded not just by resource requirements, but also by the data-dependence cycles in the graph. The graph is scheduled one strongly connected component at a time. By treating each strongly connected component as a unit, edges between strongly connected components necessarily form an acyclic graph. While the top-level loop in Algorithm 10.19 schedules nodes in the graph in topological order, the top-level loop in Algorithm 10.21 schedules strongly connected components in topological order. As before, if the algorithm fails to schedule all the components, then a larger initiation interval is tried. Note that Algorithm 10.21 behaves exactly like Algorithm 10.19 if given an acyclic data-dependence graph.

Algorithm 10.21 computes two more sets of edges:  $E'$  is the set of all edges whose iteration difference is 0,  $E^*$  is the all-points longest-path edges. That is,

```

mainQ {
  E' = {e | e in E, S_e = 0};
  To = max ( max_{j in J} En, i^n(hJ) )
           max_{c acycle in G} Z^e in c ^'
           in c ^'
  for (T = T_0, T_0 + 1, ... or until all SCC's in G are scheduled) {
    RT — an empty reservation table with T rows;
    E* = AUPairsLongestPath(G, T);
    for (each SCC C in G in prioritized topological order) {
      for (all n in C)
        S_e(n) = max_{p in P} j_n E*, p scheduled (S(p) + d_e)
      first = some n such that s_e(n) is a minimum;
      so = s_e(first);
      for (s = So; s < so + T; s = s + 1)
        if (ScsScheduled (RT, T, C, first, s)) break;
      if (C cannot be scheduled in RT) break;
    }
  }
}

ScsScheduled(RT, T, c, first, s) {
  RT' = RT;
  if (not NodeScheduled (RT', T, first, s)) return false;
  for (each remaining n in c in prioritized
       topological order of edges in E') {
    l = max_{m in E*, n' in c, n' scheduled} S(fl') + d_e — (8_e X T);
    s_e = min_{i in E*, n' in c, n' scheduled} S(fl') — d_e + ((5_e X T));
    for (s = s/; s < min(s_e, s; + T - 1); s = s + 1)
      if NodeScheduled(RT', T, n, s) break;
    if (n cannot be scheduled in RT') return false;
  }
  RT = RT';
  return true;
}

```

Figure 10.29: A software-pipelining algorithm for cyclic dependence graphs

for each pair of nodes  $(p, n)$ , there is an edge  $e$  in  $E^*$  whose associated distance  $d_e$  is the length of the longest simple path from  $p$  to  $n$ , provided that there is at least one path from  $p$  to  $n$ .  $E^*$  is computed for each value of  $T$ , the initiation-interval target. It is also possible to perform this computation just once with a symbolic value of  $T$  and then substitute for  $T$  in each iteration, as we did in Example 10.20.

Algorithm 10.21 uses backtracking. If it fails to schedule a SCC, it tries to reschedule the entire SCC a clock later. These scheduling attempts continue for up to  $T$  clocks. Backtracking is important because, as shown in Example 10.20, the placement of the first node in an SCC can fully dictate the schedule of all other nodes. If the schedule happens not to fit with the schedule created thus far, the attempt fails.

To schedule a SCC, the algorithm determines the earliest time each node in the component can be scheduled satisfying the transitive data dependences in  $E^*$ . It then picks the one with the earliest start time as the *first* node to schedule. The algorithm then invokes *SccScheduled* to try to schedule the component at the earliest start time. The algorithm makes at most  $T$  attempts with successively greater start times. If it fails, then the algorithm tries another initiation interval.

The *SccScheduled* algorithm resembles Algorithm 10.19, but has three major differences.

1. The goal of *SccScheduled* is to schedule the strongly connected component at the given time slot  $s$ . If the *first* node of the strongly connected component cannot be scheduled at  $s$ , *SccScheduled* returns false. The *main* function can invoke *SccScheduled* again with a later time slot if that is desired.
2. The nodes in the strongly connected component are scheduled in topological order, based on the edges in  $E'$ . Because the iteration differences on all the edges in  $E'$  are 0, these edges do not cross any iteration boundaries and cannot form cycles. (Edges that cross iteration boundaries are known as *loop carried*). Only loop-carried dependences place upper bounds on where operations can be scheduled. So, this scheduling order, along with the strategy of scheduling each operation as early as possible, maximizes the ranges in which subsequent nodes can be scheduled.
3. For strongly connected components, dependences impose both a lower and upper bound on the range in which a node can be scheduled. *SccScheduled* computes these ranges and uses them to further limit the scheduling attempts.

Example 10.22 : Let us apply Algorithm 10.21 to the cyclic data-dependence graph in Example 10.20. The algorithm first computes that the bound on the initiation interval for this example is 3 clocks. We note that it is not possible to meet this lower bound. When the initiation interval  $T$  is 3, the transitive

dependencies in Fig. 10.28 dictate that  $S(d) - S(b) = 2$ . Scheduling nodes  $b$  and  $d$  two clocks apart will produce a conflict in a modular resource-reservation table of length 3.

Attempt	Initiation Interval	Node	Range	Schedule	Modular Resource Reservation		
1	$T = 3$	$a$	(0,00)	0			
		$b$	(2,00)	2			
		$c$	(3,3)				
2	$T = 3$	$a$	(0,00)	0			
		$c$	(4,4)	4			
		$d$	(5,5)				
3	$T = 3$	$a$	(0,00)	0	<b>5i</b>		
		$b$	(2,00)	4			
		$c$	(5,5)	5			
		$d$	(6,6)				
4	$T = 4$	$a$	(0,00)	0			
		$b$	(2,00)	2			
		$c$	(3,4)	3			
		$d$	(4,5)				
5	$T = 4$	$a$	(0,00)	0			
		$b$	(2,00)	3			
		$c$	(4,5)	5			
		$d$	(5,5)				
6	$T = 4$	$a$	(0,00)	0			
		$b$	(2,00)	4			
		$c$	(5,6)	5			
		$d$	(6,7)	6			

Figure 10.30: Behavior of Algorithm 10.21 on Example 10.20

Figure 10.30 shows how Algorithm 10.21 behaves with this example. It first tries to find a schedule with a 3-clock initiation interval. The attempt starts by scheduling nodes  $a$  and  $b$  as early as possible. However, once node  $b$  is placed in clock 2, node  $c$  can only be placed at clock 3, which conflicts with the resource usage of node  $a$ . That is,  $a$  and  $c$  both need the first resource at clocks that have a remainder of 0 modulo 3.

The algorithm backtracks and tries to schedule the strongly connected component  $\{b, c, d\}$  a clock later. This time node  $b$  is scheduled at clock 3, and node  $c$  is scheduled successfully at clock 4. Node  $d$ , however, cannot be scheduled in

clock 5. That is, both  $b$  and  $d$  need the second resource at clocks that have a remainder of 0 modulo 3. Note that it is just a coincidence that the two conflicts discovered so far are at clocks with a remainder of 0 modulo 3; the conflict might have occurred at clocks with remainder 1 or 2 in another example.

The algorithm repeats by delaying the start of the SCC  $[b, c, d]$  by one more clock. But, as discussed earlier, this SCC can never be scheduled with an initiation interval of 3 clocks, so the attempt is bound to fail. At this point, the algorithm gives up and tries to find a schedule with an initiation interval of 4 clocks. The algorithm eventually finds the optimal schedule on its sixth attempt. •

### 10.5.9 Improvements to the Pipelining Algorithms

Algorithm 10.21 is a rather simple algorithm, although it has been found to work well on actual machine targets. The important elements in this algorithm are

1. The use of a modular resource-reservation table to check for resource conflicts in the steady state.
2. The need to compute the transitive dependence relations to find the legal range in which a node can be scheduled in the presence of dependence cycles.
3. Backtracking is useful, and nodes on *critical cycles* (cycles that place the highest lower bound on the initiation interval  $T$ ) must be rescheduled together because there is no slack between them.

There are many ways to improve Algorithm 10.21. For instance, the algorithm takes a while to realize that a 3-clock initiation interval is infeasible for the simple Example 10.22. We can schedule the strongly connected components independently first to determine if the initiation interval is feasible for each component.

We can also modify the order in which the nodes are scheduled. The order used in Algorithm 10.21 has a few disadvantages. First, because nontrivial SCC's are harder to schedule, it is desirable to schedule them first. Second, some of the registers may have unnecessarily long lifetimes. It is desirable to pull the definitions closer to the uses. One possibility is to start with scheduling strongly connected components with critical cycles first, then extend the schedule on both ends.

### 10.5.10 Modular Variable Expansion

A scalar variable is said to be *privatizable* in a loop if its live range falls within an iteration of the loop. In other words, a privatizable variable must not be live upon either entry or exit of any iteration. These variables are so named because

### Are There Alternatives to Heuristics?

We can formulate the problem of simultaneously finding an optimal software pipeline schedule and register assignment as an integer-linear-programming problem. While many integer linear programs can be solved quickly, some of them can take an exorbitant amount of time. To use an integer-linear-programming solver in a compiler, we must be able to abort the procedure if it does not complete within some preset limit.

Such an approach has been tried on a target machine (the SGI R8000) empirically, and it was found that the solver could find the optimal solution for a large percentage of the programs in the experiment within a reasonable amount of time. It turned out that the schedules produced using a heuristic approach were also close to optimal. The results suggest that, at least for that machine, it does not make sense to use the integer-linear-programming approach, especially from a software engineering perspective. Because the integer-linear solver may not finish, it is still necessary to implement some kind of a heuristic scheduler in the compiler. Once such a heuristic scheduler is in place, there is little incentive to implement a scheduler based on integer programming techniques as well.

different processors executing different iterations in a loop can have their own private copies and thus not interfere with one another.

*Variable expansion* refers to the transformation of converting a privatizable scalar variable into an array and having the  $i$ th iteration of the loop read and write the  $i$ th element. This transformation eliminates the antidependence constraints between reads in one iteration and writes in the subsequent iterations, as well as output dependences between writes from different iterations. If all loop-carried dependences can be eliminated, all the iterations in the loop can be executed in parallel.

Eliminating loop-carried dependences, and thus eliminating cycles in the data-dependence graph, can greatly improve the effectiveness of software pipelining. As illustrated by Example 10.15, we need not expand a privatizable variable fully by the number of iterations in the loop. Only a small number of iterations can be executing at a time, and privatizable variables may simultaneously be live in an even smaller number of iterations. The same storage can thus be reused to hold variables with nonoverlapping lifetimes. More specifically, if the lifetime of a register is  $I$  clocks, and the initiation interval is  $T$ , then only  $Q = ITI$  values can be live at any one point. We can allocate  $q$  registers to the variable, with the variable in the  $i$ th iteration using the  $(i \bmod q)$ th register. We refer to this transformation as *modular variable expansion*.

Algorithm 10.23 : Software pipelining with modular variable expansion.

**INPUT:** A data-dependence graph and a machine-resource description.

**OUTPUT:** Two loops, one software pipelined and one unpipelined.

**METHOD:**

1. Remove the loop-carried antidependences and output dependences associated with privatizable variables from the data-dependence graph.
2. Software-pipeline the resulting dependence graph using Algorithm 10.21. Let  $T$  be the initiation interval for which a schedule is found, and  $L$  be the length of the schedule for one iteration.
3. From the resulting schedule, compute  $q_v$ , the minimum number of registers needed by each privatizable variable  $v$ . Let  $Q = \max_v q_v$ .
4. Generate two loops: a software-pipelined loop and an unpipelined loop. The software-pipelined loop has

$$+ Q - 1$$

copies of the iterations, placed  $T$  clocks apart. It has a prolog with

$$\frac{IT}{f} - 1)T$$

instructions, a steady state with  $QT$  instructions, and an epilog of  $L - T$  instructions. Insert a loop-back instruction that branches from the bottom of the steady state to the top of the steady state.

The number of registers assigned to privatizable variable  $v$  is

$$Q_v = \begin{cases} q_v & \text{if } Q \bmod q_v = 0 \\ Q & \text{otherwise} \end{cases}$$

The variable  $v$  in iteration  $i$  uses the  $(i \bmod q_v)$ th register assigned.

Let  $n$  be the variable representing the number of iterations in the source loop. The software-pipelined loop is executed if

$$n > \frac{L}{T} + Q - 1.$$

The number of times the loop-back branch is taken is

$$n_i = \frac{n}{Q}$$

Thus, the number of source iterations executed by the software-pipelined loop is

$$r_i = \begin{cases} -1 + Qn_i & \text{if } n > \frac{L}{T} + Q - 1 \\ 0 & \text{otherwise} \end{cases}$$

The number of iterations executed by the unpipelined loop is  $n_u = n - n_i$ .

•

Example 10.24: For the software-pipelined loop in Fig. 10.22,  $L = 8$ ,  $T = 2$ , and  $Q = 2$ . The software-pipelined loop has 7 copies of the iterations, with the prolog, steady state, and epilog having 6, 4, and 6 instructions, respectively. Let  $n$  be the number of iterations in the source loop. The software-pipelined loop is executed if  $n > 5$ , in which case the loop-back branch is taken

$$\frac{n - 3}{2}$$

times, and the software-pipelined loop is responsible for

of the iterations in the source loop. •

Modular expansion increases the size of the steady state by a factor of  $Q$ . Despite this increase, the code generated by Algorithm 10.23 is still fairly compact. In the worst case, the software-pipelined loop would take three times as many instructions as that of the schedule for one iteration. Roughly, together with the extra loop generated to handle the left-over iterations, the total code size is about four times the original. This technique is usually applied to tight inner loops, so this increase is reasonable.

Algorithm 10.23 minimizes code expansion at the expense of using more registers. We can reduce register usage by generating more code. We can use the minimum  $q_v$  registers for each variable  $v$  if we use a steady state with

$$T \times \text{LCM}_v q_v$$

instructions. Here,  $\text{LCM}_v$  represents the operation of taking the *least common multiple* of all the  $q_v$ 's, as  $v$  ranges over all the privatizable variables (i.e., the smallest integer that is an integer multiple of all the  $q_v$ 's). Unfortunately, the least common multiple can be quite large even for a few small  $q_v$ 's.

### 10.5.11 Conditional Statements

If predicated instructions are available, we can convert control-dependent instructions into predicated ones. Predicated instructions can be software-pipelined like any other operations. However, if there is a large amount of data-dependent control flow within the loop body, scheduling techniques described in Section 10.4 may be more appropriate.

If a machine does not have predicated instructions, we can use the concept of *hierarchical reduction*, described below, to handle a small amount of data-dependent control flow. Like Algorithm 10.11, in hierarchical reduction the control constructs in the loop are scheduled inside-out, starting with the most



deeply nested structures. As each construct is scheduled, the entire construct is reduced to a single node representing all the scheduling constraints of its components with respect to the other parts of the program. This node can then be scheduled as if it were a simple node within the surrounding control construct. The scheduling process is complete when the entire program is reduced to a single node.

In the case of a conditional statement with "then" and "else" branches, we schedule each of the branches independently. Then:

1. The constraints of the entire conditional statement are conservatively taken to be the union of the constraints from both branches.
2. Its resource usage is the maximum of the resources used in each branch.
3. Its precedence constraints are the union of those in each branch, obtained by pretending that both branches are executed.

This node can then be scheduled like any other node. Two sets of code, corresponding to the two branches, are generated. Any code scheduled in parallel with the conditional statement is duplicated in both branches. If multiple conditional statements are overlapped, separate code must be generated for each combination of branches executed in parallel.

### 10.5.12 Hardware Support for Software Pipelining

Specialized hardware support has been proposed for minimizing the size of software-pipelined code. The *rotating register file* in the Itanium architecture is one such example. A rotating register file has a *base register*, which is added to the register number specified in the code to derive the actual register accessed. We can get different iterations in a loop to use different registers simply by changing the contents of the base register at the boundary of each iteration. The Itanium architecture also has extensive predicated instruction support. Not only can predication be used to convert control dependence to data dependence but it also can be used to avoid generating the prologs and epilogs. The body of a software-pipelined loop contains a superset of the instructions issued in the prolog and epilog. We can simply generate the code for the steady state and use predication appropriately to suppress the extra operations to get the effects of having a prolog and an epilog.

While Itanium's hardware support improves the density of software-pipelined code, we must also realize that the support is not cheap. Since software pipelining is a technique intended for tight innermost loops, pipelined loops tend to be small anyway. Specialized support for software pipelining is warranted principally for machines that are intended to execute many software-pipelined loops and in situations where it is very important to minimize code size.

```

1) L: LD R1, a(R9)
2)    ST b(R9), R1
3)    LD R2, c(R9)
4)    ADD R3, R1, R2
5)    ST c(R9), R3
6)    SUB R4, R1, R2
7)    ST b(R9), R4
8)    BL R9, L

```

Figure 10.31 Machine code for Exercise 10.5.2

### 10.5.13 Exercises for Section 10.5

**Exercise 10.5.1:** In Example 10.20 we showed how to establish the bounds on the relative clocks at which  $b$  and  $c$  are scheduled. Compute the bounds for each of five other pairs of nodes (i) for general  $T$  (ii) for  $T = 3$  (iii) for  $T = 4$ .

**Exercise 10.5.2:** In Fig. 10.31 is the body of a loop. Addresses such as  $a(R9)$  are intended to be memory locations, where  $a$  is a constant, and  $R9$  is the register that counts iterations through the loop. You may assume that each iteration of the loop accesses different locations, because  $R9$  has a different value. Using the machine model of Example 10.12, schedule the loop of Fig. 10.31 in the following ways:

- a) Keeping each iteration as tight as possible (i.e., only introduce one nop after each arithmetic operation), unroll the loop twice. Schedule the second iteration to commence at the earliest possible moment without violating the constraint that the machine can only do one load, one store, one arithmetic operation, and one branch at any clock.
- b) Repeat part (a), but unroll the loop three times. Again, start each iteration as soon as you can, subject to the machine constraints.
- ! c) Construct fully pipelined code subject to the machine constraints. In this part, you can introduce extra nop's if needed, but you must start a new iteration every two clock ticks.

**Exercise 10.5.3:** A certain loop requires 5 loads, 7 stores, and 8 arithmetic operations. What is the minimum initiation interval for a software pipelining of this loop on a machine that executes each operation in one clock tick, and has resources enough to do, in one clock tick:

- a) 3 loads, 4 stores, and 5 arithmetic operations.
- b) 3 loads, 3 stores, and 3 arithmetic operations.

**! Exercise 10.5.4:** Using the machine model of Example 10.12, Find the minimum initiation interval and a uniform schedule for the iterations, for the following loop:

```

for (i = 1; i < n; i++) {
    A[i] = B[i-1] + 1;
    B[i] = A[i-1] + 2;
}

```

Remember that the counting of iterations is handled by auto-increment of registers, and no operations are needed solely for the counting associated with the for-loop.

**! Exercise 10.5.5:** Prove that Algorithm 10.19, in the special case where every operation requires only one unit of one resource, can always find a software-pipeline schedule meeting the lower bound.

**! Exercise 10.5.6:** Suppose we have a cyclic data-dependence graph with nodes  $a$ ,  $b$ ,  $c$ , and  $d$ . There are edges from  $a$  to  $b$  and from  $c$  to  $d$  with label  $(0,1)$  and there are edges from  $b$  to  $c$  and from  $d$  to  $a$  with label  $(1,1)$ . There are no other edges.

- a) Draw the cyclic dependence graph.
- b) Compute the table of longest simple paths among the nodes.
- c) Show the lengths of the longest simple paths if the initiation interval  $T$  is 2.
- d) Repeat (c) if  $T = 3$ .
- e) For  $T = 3$ , what are the constraints on the relative times that each of the instructions represented by  $a$ ,  $b$ ,  $c$ , and  $d$  may be scheduled?

**! Exercise 10.5.7:** Give an  $O(n^3)$  algorithm to find the length of the longest simple path in an  $n$ -node graph, on the assumption that no cycle has a positive length. *Hint:* Adapt Floyd's algorithm for shortest paths (see, e.g., A. V. Aho and J. D. Ullman, *Foundations of Computer Science*, Computer Science Press, New York, 1992).

**!! Exercise 10.5.8:** Suppose we have a machine with three instruction types, which we'll call  $A$ ,  $B$ , and  $C$ . All instructions require one clock tick, and the machine can execute one instruction of each type at each clock. Suppose a loop consists of six instructions, two of each type. Then it is possible to execute the loop in a software pipeline with an initiation interval of two. However, some sequences of the six instructions require insertion of one delay, and some require insertion of two delays. Of the 90 possible sequences of two  $A$ 's, two  $B$ 's and two  $C$ 's, how many require no delay? How many require one delay?

*Hint:* There is symmetry among the three instruction types so two sequences that can be transformed into one another by permuting the names *A*, *B*, and *C* must require the same number of delays. For example, *ABBCAC* must be the same as *BCCABA*.

## 10.6 Summary of Chapter 10

- 4- *Architectural Issues:* Optimized code scheduling takes advantage of features of modern computer architectures. Such machines often allow pipelined execution, where several instructions are in different stages of execution at the same time. Some machines also allow several instructions to begin execution at the same time.
- 4- *Data Dependences:* When scheduling instructions, we must be aware of the effect instructions have on each memory location and register. True data dependences occur when one instruction must read a location after another has written it. Antidependences occur when there is a write after a read, and output dependences occur when there are two writes to the same location.
  - *Eliminating Dependences:* By using additional locations to store data, antidependences and output dependences can be eliminated. Only true dependences cannot be eliminated and must surely be respected when the code is scheduled.
  - *Data-Dependence Graphs for Basic Blocks:* These graphs represent the timing constraints among the statements of a basic block. Nodes correspond to the statements. An edge from *n* to *m* labeled *d* says that the instruction *m* must start at least *d* clock cycles after instruction *n* starts.
- 4- *Prioritized Topological Orders:* The data-dependence graph for a basic block is always acyclic, and there usually are many topological orders consistent with the graph. One of several heuristics can be used to select a preferred topological order for a given graph, e.g., choose nodes with the longest critical path first.
  - *List Scheduling:* Given a prioritized topological order for a data-dependence graph, we may consider the nodes in that order. Schedule each node at the earliest clock cycle that is consistent with the timing constraints implied by the graph edges, the schedules of all previously scheduled nodes, and the resource constraints of the machine.
  - *Interblock Code Motion:* Under some circumstances it is possible to move statements from the block in which they appear to a predecessor or successor block. The advantage is that there may be opportunities to execute instructions in parallel at the new location that do not exist at the original location. If there is not a dominance relation between the old and

new locations, it may be necessary to insert compensation code along certain paths, in order to make sure that exactly the same sequence of instructions is executed, regardless of the flow of control.

- *Do-All Loops:* A do-all loop has no dependences across iterations, so any iterations may be executed in parallel.
- 4- *Software Pipelining of Do-All Loops:* Software pipelining is a technique for exploiting the ability of a machine to execute several instructions at once. We schedule iterations of the loop to begin at small intervals, perhaps placing no-op instructions in the iterations to avoid conflicts between iterations for the machine's resources. The result is that the loop can be executed quickly, with a preamble, a coda, and (usually) a tiny inner loop.
- *Do-Across Loops:* Most loops have data dependences from each iteration to later iterations. These are called do-across loops.
- *Data-Dependence Graphs for Do-Across Loops:* To represent the dependences among instructions of a do-across loop requires that the edges be labeled by a pair of values: the required delay (as for graphs representing basic blocks) and the number of iterations that elapse between the two instructions that have a dependence.
- *List Scheduling of Loops:* To schedule a loop, we must choose the one schedule for all the iterations, and also choose the initiation interval at which successive iterations commence. The algorithm involves deriving the constraints on the relative schedules of the various instructions in the loop by finding the length of the longest acyclic paths between the two nodes. These lengths have the initiation interval as a parameter, and thus put a lower bound on the initiation interval.

## 10.7 References for Chapter 10

For a more in-depth discussion on processor architecture and design, we recommend Hennessy and Patterson [5].

The concept of data dependence was first discussed in Kuck, Muraoka, and Chen [6] and Lamport [8] in the context of compiling code for multiprocessors and vector machines.

Instruction scheduling was first used in scheduling horizontal microcode ([2, 3, 11, and 12]). Fisher's work on microcode compaction led him to propose the concept of a VLIW machine, where compilers directly can control the parallel execution of operations [3]. Gross and Hennessy [4] used instruction scheduling to handle the delayed branches in the first MIPS RISC instruction set. This chapter's algorithm is based on Bernstein and Rodeh's [1] more general treatment of scheduling of operations for machines with instruction-level parallelism.

The basic idea behind software pipelining was first developed by Patel and Davidson [9] for scheduling hardware pipelines. Software pipelining was first used by Rau and Glaeser [10] to compile for a machine with specialized hardware designed to support software pipelining. The algorithm described here is based on Lam [7], which assumes no specialized hardware support.

1. Bernstein, D. and M. Rodeh, "Global instruction scheduling for super-scalar machines," *Proc. ACM SIGPLAN 1991 Conference on Programming Language Design and Implementation*, pp. 241-255.
2. Dasgupta, S., "The organization of microprogram stores," *Computing Surveys* 11:1 (1979), pp. 39-65.
3. Fisher, J. A., "Trace scheduling: a technique for global microcode compaction," *IEEE Trans. on Computers* C-30:7 (1981), pp. 478-490.
4. Gross, T. R. and Hennessy, J. L., "Optimizing delayed branches," *Proc. 15th Annual Workshop on Microprogramming* (1982), pp. 114-120.
5. Hennessy, J. L. and D. A. Patterson, *Computer Architecture: A Quantitative Approach*, Third Edition, Morgan Kaufman, San Francisco, 2003.
6. Kuck, D., Y. Muraoka, and S. Chen, "On the number of operations simultaneously executable in Fortran-like programs and their resulting speedup," *IEEE Transactions on Computers* C-21:12 (1972), pp. 1293-1310.
7. Lam, M. S., "Software pipelining: an effective scheduling technique for VLIW machines," *Proc. ACM SIGPLAN 1988 Conference on Programming Language Design and Implementation*, pp. 318-328.
8. Lamport, L., "The parallel execution of DO loops," *Comm. ACM* 17:2 (1974), pp. 83-93.
9. Patel, J. H. and E. S. Davidson, "Improving the throughput of a pipeline by insertion of delays," *Proc. Third Annual Symposium on Computer Architecture* (1976), pp. 159-164.
10. Rau, B. R. and C. D. Glaeser, "Some scheduling techniques and an easily schedulable horizontal architecture for high performance scientific computing," *Proc. 14th Annual Workshop on Microprogramming* (1981), pp. 183-198.
11. Tokoro, M., E. Tamura, and T. Takizuka, "Optimization of microprograms," *IEEE Trans. on Computers* C-30:7 (1981), pp. 491-504.
12. Wood, G., "Global optimization of microprograms through modular control constructs," *Proc. 12th Annual Workshop in Microprogramming* (1979), pp. 1-6.



## Chapter 11

# Optimizing for Parallelism and Locality

This chapter shows how a compiler can enhance parallelism and locality in computationally intensive programs involving arrays to speed up target programs running on multiprocessor systems. Many scientific, engineering, and commercial applications have an insatiable need for computational cycles. Examples include weather prediction, protein-folding for designing drugs, fluid-dynamics for designing aeropropulsion systems, and quantum chromodynamics for studying the strong interactions in high-energy physics.

One way to speed up a computation is to use parallelism. Unfortunately, it is not easy to develop software that can take advantage of parallel machines. Dividing the computation into units that can execute on different processors in parallel is already hard enough; yet that by itself does not guarantee a speedup. We must also minimize interprocessor communication, because communication overhead can easily make the parallel code run even slower than the sequential execution!

Minimizing communication can be thought of as a special case of improving a program's *data locality*. In general, we say that a program has good data locality if a processor often accesses the same data it has used recently. Surely if a processor on a parallel machine has good locality, it does not need to communicate with other processors frequently. Thus, parallelism and data locality need to be considered hand-in-hand. Data locality, by itself, is also important for the performance of individual processors. Modern processors have one or more level of caches in the memory hierarchy; a memory access can take tens of machine cycles whereas a cache hit would only take a few cycles. If a program does not have good data locality and misses in the cache often, its performance will suffer.

Another reason why parallelism and locality are treated together in this same chapter is that they share the same theory. If we know how to optimize for data locality, we know where the parallelism is. You will see in this chapter that the



program model we used for data-flow analysis in Chapter 9 is inadequate for parallelization and locality optimization. The reason is that work on data-flow analysis assumes we don't distinguish among the ways a given statement is reached, and in fact these Chapter 9 techniques take advantage of the fact that we don't distinguish among different executions of the same statement, e.g., in a loop. To parallelize a code, we need to reason about the dependences among different dynamic executions of the same statement to determine if they can be executed on different processors simultaneously.

This chapter focuses on techniques for optimizing the class of numerical applications that use arrays as data structures and access them with simple regular patterns. More specifically, we study programs that have *affine* array accesses with respect to surrounding loop indexes. For example, if  $i$  and  $j$  are the index variables of surrounding loops, then  $Z[i][j]$  and  $Z[i][i + j]$  are affine accesses. A function of one or more variables,  $i_1, i_2, \dots, i_n$ , is *affine* if it can be expressed as a sum of a constant, plus constant multiples of the variables, i.e.,  $C_0 + c_1 X_1 + c_2 X_2 + \dots + c_n X_n$ , where  $C_0, c_1, \dots, c_n$  are constants. Affine functions are usually known as linear functions, although strictly speaking, linear functions do not have the  $CQ$  term.

Here is a simple example of a loop in this domain:

```
for (i = 0; i < 10; i++) {
    Z[i] = 0;
}
```

Because iterations of the loop write to different locations, different processors can execute different iterations concurrently. On the other hand, if there is another statement  $Z[j] = 1$  being executed, we need to worry about whether  $i$  could ever be the same as  $j$ , and if so, in which order do we execute those instances of the two statements that share a common value of the array index.

Knowing which iterations can refer to the same memory location is important. This knowledge lets us specify the data dependences that must be honored when scheduling code for both uniprocessors and multiprocessors. Our objective is to find a schedule that honors all the data dependences such that operations that access the same location and cache lines are performed close together if possible, and on the same processor in the case of multiprocessors.

The theory we present in this chapter is grounded in linear algebra and integer programming techniques. We model iterations in an  $n$ -deep loop nest as an  $n$ -dimensional polyhedron, whose boundaries are specified by the bounds of the loops in the code. Affine functions map each iteration to the array locations it accesses. We can use integer linear programming to determine if there exist two iterations that can refer to the same location.

The set of code transformations we discuss here fall into two categories: *affine partitioning* and *blocking*. Affine partitioning splits up the polyhedron of iterations into components, to be executed either on different machines or one-by-one sequentially. On the other hand, blocking creates a hierarchy of iterations. Suppose we are given a loop that sweeps through an array row-by-

row. We may instead subdivide the array into blocks and visit all elements in a block before moving to the next. The resulting code will consist of outer loops traversing the blocks, and then inner loops to sweep the elements within each block. Linear algebra techniques are used to determine both the best affine partitions and the best blocking schemes.

In the following, we first start with an overview of the concepts in parallel computation and locality optimization in Section 11.1. Then, Section 11.2 is an extended concrete example — matrix multiplication — that shows how *loop transformations* that reorder the computation inside a loop can improve both locality and the effectiveness of parallelization.

Sections 11.3 to Sections 11.6 present the preliminary information necessary for loop transformations. Section 11.3 shows how we model the individual iterations in a loop nest; Section 11.4 shows how we model array index functions that map each loop iteration to the array locations accessed by the iteration; Section 11.5 shows how to determine which iterations in a loop refer to the same array location or the same cache line using standard linear algebra algorithms; and Section 11.6 shows how to find all the data dependences among array references in a program.

The rest of the chapter applies these preliminaries in coming up with the optimizations. Section 11.7 first looks at the simpler problem of finding parallelism that requires no synchronization. To find the best affine partitioning, we simply find the solution to the constraint that operations that share a data dependence must be assigned to the same processor.

Well, not too many programs can be parallelized without requiring any synchronization. Thus, in Sections 11.8 through 11.9.9, we consider the general case of finding parallelism that requires synchronization. We introduce the concept of pipelining, show how to find the affine partitioning that maximizes the degree of pipelining allowed by a program. We show how to optimize for locality in Section 11.10. Finally, we discuss how affine transforms are useful for optimizing for other forms of parallelism.

## 11.1 Basic Concepts

This section introduces the basic concepts related to parallelization and locality optimization. If operations can be executed in parallel, they also can be reordered for other goals such as locality. Conversely, if data dependences in a program dictate that instructions in a program must execute serially, there is obviously no parallelism, nor is there any opportunity to reorder instructions to improve locality. Thus parallelization analysis also finds the available opportunities for code motion to improve data locality.

To minimize communication in parallel code, we group together all related operations and assign them to the same processor. The resulting code must therefore have data locality. One crude approach to getting good data locality on a uniprocessor is to have the processor execute the code assigned to each

processor in succession.

In this introduction, we start by presenting an overview of parallel computer architectures. We then show the basic concepts in parallelization, the kind of transformations that can make a big difference, as well as the concepts useful for parallelization. We then discuss how similar considerations can be used to optimize locality. Finally, we introduce informally the mathematical concepts used in this chapter.

### 11.1.1 Multiprocessors

The most popular parallel machine architecture is the symmetric multiprocessor (SMP). High-performance personal computers often have two processors, and many server machines have four, eight, and some even tens of processors. Moreover, as it has become feasible for several high-performance processors to fit on a single chip, multiprocessors have become even more widely used.

Processors on a symmetric multiprocessor share the same address space. To communicate, a processor can simply write to a memory location, which is then read by any other processor. Symmetric multiprocessors are so named because all processors can access all of the memory in the system with a uniform access time. Fig. 11.1 shows the high-level architecture of a multiprocessor. The processors may have their own first-level, second-level, and in some cases, even a third-level cache. The highest-level caches are connected to physical memory through typically a shared bus.

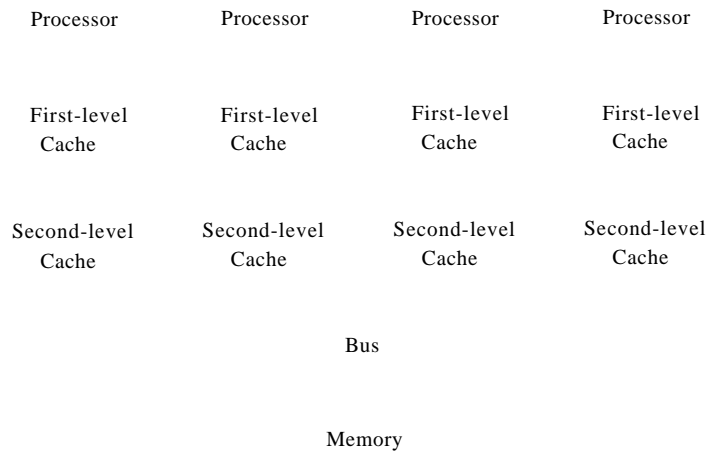

Figure 11.1: The symmetric multi-processor architecture

Symmetric multiprocessors use a *coherent cache protocol* to hide the presence of caches from the programmer. Under such a protocol, several processors are

allowed to keep copies of the same cache line<sup>1</sup> at the same time, provided that they are only reading the data. When a processor wishes to write to a cache line, copies from all other caches are removed. When a processor requests data not found in its cache, the request goes out on the shared bus, and the data will be fetched either from memory or from the cache of another processor.

The time taken for one processor to communicate with another is about twice the cost of a memory access. The data, in units of cache lines, must first be written from the first processor's cache to memory, and then fetched from the memory to the cache of the second processor. You may think that interprocessor communication is relatively cheap, since it is only about twice as slow as a memory access. However, you must remember that memory accesses are very expensive when compared to cache hits—they can be a hundred times slower. This analysis brings home the similarity between efficient parallelization and locality analysis. For a processor to perform well, either on its own or in the context of a multiprocessor, it must find most of the data it operates on in its cache.

In the early 2000's, the design of symmetric multiprocessors no longer scaled beyond tens of processors, because the shared bus, or any other kind of interconnect for that matter, could not operate at speed with the increasing number of processors. To make processor designs scalable, architects introduced yet another level in the memory hierarchy. Instead of having memory that is equally far away for each processor, they distributed the memories so that each processor could access its local memory quickly as shown in Fig. 11.2. Remote memories thus constituted the next level of the memory hierarchy; they are collectively bigger but also take longer to access. Analogous to the principle in memory-hierarchy design that fast stores are necessarily small, machines that support fast interprocessor communication necessarily have a small number of processors.

There are two variants of a parallel machine with distributed memories: NUM A (nonuniform memory access) machines and message-passing machines. NUM A architectures provide a shared address space to the software, allowing processors to communicate by reading and writing shared memory. On message-passing machines, however, processors have disjoint address spaces, and processors communicate by sending messages to each other. Note that even though it is simpler to write code for shared memory machines, the software must have good locality for either type of machine to perform well.

### 11.1.2 Parallelism in Applications

We use two high-level metrics to estimate how well a parallel application will perform: *parallelism coverage* which is the percentage of the computation that runs in parallel, *granularity of parallelism*, which is the amount of computation that each processor can execute without synchronizing or communicating with others. One particularly attractive target of parallelization is loops: a loop may

<sup>1</sup>You may wish to review the discussion of caches and cache lines in Section 7.4.

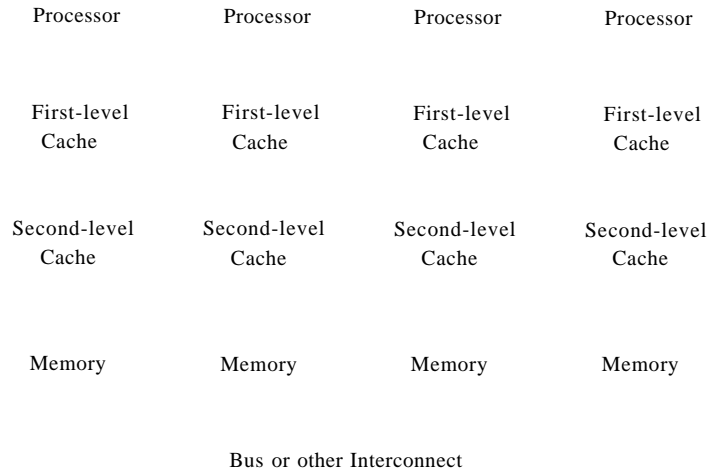

Figure 11.2: Distributed memory machines

have many iterations, and if they are independent of each other, we have found a great source of parallelism.

### Amdahl's Law

The significance of parallelism coverage is succinctly captured by Amdahl's Law. *Amdahl's Law* states that, if  $f$  is the fraction of the code parallelized, and if the parallelized version runs on a  $p$ -processor machine with no communication or parallelization overhead, the speedup is

$$\frac{1}{(1 - f) + (f/p)}$$

For example, if half of the computation remains sequential, the computation can only double in speed, regardless of how many processors we use. The speedup achievable is a factor of 1.6 if we have 4 processors. Even if the parallelism coverage is 90%, we get at most a factor of 3 speed up on 4 processors, and a factor of 10 on an unlimited number of processors.

### Granularity of Parallelism

It is ideal if the entire computation of an application can be partitioned into many independent coarse-grain tasks because we can simply assign the different tasks to different processors. One such example is the SETI (Search for Extra-Terrestrial Intelligence) project, which is an experiment that uses home computers connected over the Internet to analyze different portions of radio telescope data in parallel. Each unit of work, requiring only a small amount

of input and generating a small amount of output, can be performed independently of all others. As a result, such a computation runs well on machines over the Internet, which has relatively high communication latency (delay) and low bandwidth.

Most applications require more communication and interaction between processors, yet still allow coarse-grained parallelism. Consider, for example, the web server responsible for serving a large number of mostly independent requests out of a common database. We can run the application on a multiprocessor, with a thread implementing the database and a number of other threads servicing user requests. Other examples include drug design or airfoil simulation, where the results of many different parameters can be evaluated independently. Sometimes the evaluation of even just one set of parameters in a simulation takes so long that it is desirable to speed it up with parallelization. As the granularity of available parallelism in an application decreases, better interprocessor communication support and more programming effort are needed.

Many long-running scientific and engineering applications, with their simple control structures and large data sets, can be more readily parallelized at a finer grain than the applications mentioned above. Thus, this chapter is devoted primarily to techniques that apply to numerical applications, and in particular, to programs that spend most of their time manipulating data in multidimensional arrays. We shall examine this class of programs next.

### 11.1.3 Loop-Level Parallelism

Loops are the main target for parallelization, especially in applications using arrays. Long running applications tend to have large arrays, which lead to loops that have many iterations, one for each element in the array. It is not uncommon to find loops whose iterations are independent of one another. We can divide the large number of iterations of such loops among the processors. If the amount of work performed in each iteration is roughly the same, simply dividing the iterations evenly across processors will achieve maximum parallelism. Example 11.1 is an extremely simple example showing how we can take advantage of loop-level parallelism.

**Example 11.1:** The loop

```
for (i = 0; i < n; i++) {  
    z[i] = x[i] - y[i];  
    z[i] = z[i] * z[i];  
}
```

computes the square of differences between elements in vectors  $X$  and  $Y$  and stores it into  $Z$ . The loop is parallelizable because each iteration accesses a different set of data. We can execute the loop on a computer with  $M$  processors by giving each processor an unique ID  $p = 0, 1, \dots, M - 1$  and having each processor execute the same code:

## Task-Level Parallelism

It is possible to find parallelism outside of iterations in a loop. For example, we can assign two different function invocations, or two independent loops, to two processors. This form of parallelism is known as *task parallelism*. The task level is not as attractive a source of parallelism as is the loop level. The reason is that the number of independent tasks is a constant for each program and does not scale with the size of the data, as does the number of iterations of a typical loop. Moreover, the tasks generally are not of equal size, so it is hard to keep all the processors busy all the time.

```

b = ceil(n/M);
for (i = b*p; i < min(n,b*(p+1)); i++) {
    Z[i] = X[i] - Y[i];
    Z[i] = Z[i] * Z[i];
}

```

We divide the iterations in the loop evenly among the processors; the  $p$ th processor is given the  $p$ th swath of iterations to execute. Note that the number of iterations may not be divisible by  $M$ , so we assure that the last processor does not execute past the bound of the original loop by introducing a minimum operation. •

The parallel code shown in Example 11.1 is an SPMD (Single Program Multiple Data) program. The same code is executed by all processors, but it is parameterized by an identifier unique to each processor, so different processors can take different actions. Typically one processor, known as the *master*, executes all the serial part of the computation. The master processor, upon reaching a parallelized section of the code, wakes up all the *slave* processors. All the processors execute the parallelized regions of the code. At the end of each parallelized region of code, all the processors participate in a *barrier synchronization*. Any operation executed before a processor enters a synchronization barrier is guaranteed to be completed before any other processors are allowed to leave the barrier and execute operations that come after the barrier.

If we parallelize only little loops like those in Example 11.1, then the resulting code is likely to have low parallelism coverage and relatively fine-grain parallelism. We prefer to parallelize the outermost loops in a program, as that yields the coarsest granularity of parallelism. Consider, for example, the application of a two-dimensional FFT transformation that operates on an  $n \times n$  data set. Such a program performs  $n$  FFT's on the rows of the data, then another  $n$  FFT's on the columns. It is preferable to assign each of the  $n$  independent FFT's to one processor each, rather than trying to use several processors to collaborate on one FFT. The code is easier to write, the parallelism coverage

for the algorithm is 100%, and the code has good data locality as it requires no communication at all while computing an FFT.

Many applications do not have large outermost loops that are parallelizable. The execution time of these applications, however, is often dominated by time-consuming *kernels*, which may have hundreds of lines of code consisting of loops with different nesting levels. It is sometimes possible to take the kernel, reorganize its computation and partition it into mostly independent units by focusing on its locality.

### 11.1.4 Data Locality

There are two somewhat different notions of data locality that need to be considered when parallelizing programs. *Temporal* locality occurs when the same data is used several times within a short time period. *Spatial* locality occurs when different data elements that are located near to each other are used within a short period of time. An important form of spatial locality occurs when all the elements that appear on one cache line are used together. The reason is that as soon as one element from a cache line is needed, all the elements in the same line are brought to the cache and will probably still be there if they are used soon. The effect of this spatial locality is that cache misses are minimized, with a resulting important speedup of the program.

Kernels can often be written in many semantically equivalent ways but with widely varying data localities and performances. Example 11.2 shows an alternative way of expressing the computation in Example 11.1.

Example 11.2: Like Example 11.1 the following also finds the squares of differences between elements in vectors  $X$  and  $Y$ .

```

for (i = 0; i < n; i++)
    Z[i] = X[i] - Y[i];
for (i = 0; i < n; i++)
    Z[i] = Z[i] * Z[i];

```

The first loop finds the differences, the second finds the squares. Code like this appears often in real programs, because that is how we can optimize a program for *vector machines*, which are supercomputers which have instructions that perform simple arithmetic operations on vectors at a time. We see that the bodies of the two loops here are *fused* as one in Example 11.1.

Given that the two programs perform the same computation, which performs better? The fused loop in Example 11.1 has better performance because it has better data locality. Each difference is squared immediately, as soon as it is produced; in fact, we can hold the difference in a register, square it, and write the result just once into the memory location  $Z[i]$ . In contrast, the code in Example 11.1 fetches  $Z[i]$  once, and writes it twice. Moreover, if the size of the array is larger than the cache,  $Z[i]$  needs to be refetched from memory the second time it is used in this example. Thus, this code can run significantly slower. •



```

for (j = 0; j < n; j++)
  for (i = 0; i < n; i++)
    Z[i,j] = 0;

```

(a) Zeroing an array column-by-column.

```

for (i = 0; i < n; i++)
  for (j = 0; j < n; j++)
    Z[i,j] = 0;

```

(b) Zeroing an array row-by-row.

```

b = ceil(n/M);
for (i = b*p; i < min(n,b*(p+1)); i++)
  for (j = 0; j < n; j++)
    Z[i,j] = 0;

```

(c) Zeroing an array row-by-row in parallel.

Figure 11.3: Sequential and parallel code for zeroing an array

**Example 11.3:** Suppose we want to set array  $\mathbf{Z}$ , stored in row-major order (recall Section 6.4.3), to all zeros. Fig. 11.3(a) and (b) sweeps through the array column-by-column and row-by-row, respectively. We can transpose the loops in Fig. 11.3(a) to arrive at Fig. 11.3(b). In terms of spatial locality, it is preferable to zero out the array row-by-row since all the words in a cache line are zeroed consecutively. In the column-by-column approach, even though each cache line is reused by consecutive iterations of the outer loop, cache lines will be thrown out before reuse if the size of a column is greater than the size of the cache. For best performance, we parallelize the outer loop of Fig. 11.3(b) in a manner similar to that used in Example 11.1. •

The two examples above illustrate several important characteristics associated with numeric applications operating on arrays:

- Array code often has many parallelizable loops.
- When loops have parallelism, their iterations can be executed in arbitrary order; they can be reordered to improve data locality drastically.
- As we create large units of parallel computation that are independent of each other, executing these serially tends to produce good data locality.

### 11.1.5 Introduction to Affine Transform Theory

Writing correct and efficient sequential programs is difficult; writing parallel programs that are correct and efficient is even harder. The level of difficulty

increases as the granularity of parallelism exploited decreases. As we see above, programmers must pay attention to data locality to get high performance. Furthermore, the task of taking an existing sequential program and parallelizing it is extremely hard. It is hard to catch all the dependences in the program, especially if it is not a program with which we are familiar. Debugging a parallel program is harder yet, because errors can be nondeterministic.

Ideally, a parallelizing compiler automatically translates ordinary sequential programs into efficient parallel programs and optimizes the locality of these programs. Unfortunately, compilers without high-level knowledge about the application, can only preserve the semantics of the original algorithm, which may not be amenable to parallelization. Furthermore, programmers may have made arbitrary choices that limit the program's parallelism.

Successes in parallelization and locality optimizations have been demonstrated for Fortran numeric applications that operate on arrays with affine accesses. Without pointers and pointer arithmetic, Fortran is easier to analyze. Note that not all applications have affine accesses; most notably, many numeric applications operate on sparse matrices whose elements are accessed indirectly through another array. This chapter focuses on the parallelization and optimizations of kernels, consisting of mostly tens of lines.

As illustrated by Examples 11.2 and 11.3, parallelization and locality optimization require that we reason about the different instances of a loop and their relations with each other. This situation is very different from data-flow analysis, where we combine information associated with all instances together.

For the problem of optimizing loops with array accesses, we use three kinds of spaces. Each space can be thought of as points on a grid of one or more dimensions.

1. The *iteration space* is the set of the dynamic execution instances in a computation, that is, the set of combinations of values taken on by the loop indexes.
2. The *data space* is the set of array elements accessed.
3. The *processor space* is the set of processors in the system. Normally, these processors are assigned integer numbers or vectors of integers to distinguish among them.

Given as input are a sequential order in which the iterations are executed and affine array-access functions (e.g.,  $X[iJ + 1]$ ) that specify which instances in the iteration space access which elements in the data space.

The output of the optimization, again represented as affine functions, defines what each processor does and when. To specify what each processor does, we use an affine function to assign instances in the original iteration space to processors. To specify when, we use an affine function to map instances in the iteration space to a new ordering. The schedule is derived by analyzing the array-access functions for data dependences and reuse patterns.

The following example will illustrate the three spaces — iteration, data, and processor. It will also introduce informally the important concepts and issues that need to be addressed in using these spaces to parallelize code. The concepts each will be covered in detail in later sections.

Example 11.4: Figure 11.4 illustrates the different spaces and their relations used in the following program:

```
float Z[100] ;
for (i = 0; i < 10; i++)
    Z[i+10] = Z[i] ;
```

The three spaces and the mappings among them are as follows:

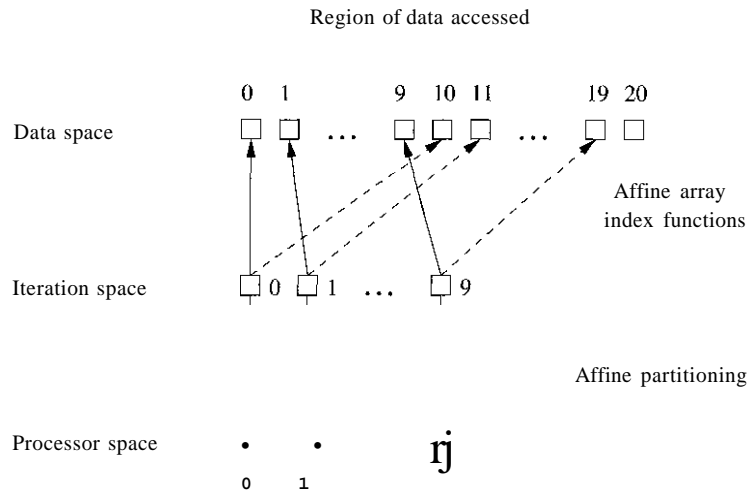

Figure 11.4: Iteration, data, and processor space for Example 11.4

1. *Iteration Space:* The iteration space is the set of iterations, whose ID's are given by the values held by the loop index variables. A  $d$ -deep *loop nest* (i.e.,  $d$  nested loops) has  $d$  index variables, and is thus modeled by a  $\mathbf{G}^d$ -dimensional space. The space of iterations is bounded by the lower and upper bounds of the loop indexes. The loop of this example defines a one-dimensional space of 10 iterations, labeled by the loop index values:  $i = 0, 1, \dots, 9$ .
2. *Data Space:* The data space is given directly by the array declarations. In this example, elements in the array are indexed by  $a = 0, 1, \dots, 99$ . Even though all arrays are linearized in a program's address space, we treat  $n$ -dimensional arrays as  $n$ -dimensional spaces, and assume that the individual indexes stay within their bounds. In this example, the array is one-dimensional anyway.

3. *Processor Space:* We pretend that there are an unbounded number of virtual processors in the system as our initial parallelization target. The processors are organized in a multidimensional space, one dimension for each loop in the nest we wish to parallelize. After parallelization, if we have fewer physical processors than virtual processors, we divide the virtual processors into even blocks, and assign a block each to a processor. In this example, we need only ten processors, one for each iteration of the loop. We assume in Fig. 11.4 that processors are organized in a one-dimensional space and numbered  $0, 1, \dots, 9$ , with loop iteration  $i$  assigned to processor  $i$ . If there were, say, only five processors, we could assign iterations 0 and 1 to processor 0, iterations 2 and 3 to processor 1, and so on. Since iterations are independent, it doesn't matter how we do the assignment, as long as each of the five processors gets two iterations.
4. *Affine Array-Index Function:* Each array access in the code specifies a mapping from an iteration in the iteration space to an array element in the data space. The access function is affine if it involves multiplying the loop index variables by constants and adding constants. Both the array index functions  $i + 10$ , and  $i$  are affine. From the access function, we can tell the *dimension* of the data accessed. In this case, since each index function has one loop variable, the space of accessed array elements is one dimensional.
5. *Affine Partitioning:* We parallelize a loop by using an affine function to assign iterations in an iteration space to processors in the processor space. In our example, we simply assign iteration  $i$  to processor  $i$ . We can also specify a new execution order with affine functions. If we wish to execute the loop above sequentially, but in reverse, we can specify the ordering function succinctly with an affine expression  $10 - i$ . Thus, iteration 9 is the 1st iteration to execute and so on.
6. *Region of Data Accessed:* To find the best affine partitioning, it useful to know the region of data accessed by an iteration. We can get the region of data accessed by combining the iteration space information with the array index function. In this case, the array access  $Z[i + 10]$  touches the region  $\{a \mid 10 < a < 20\}$  and the access  $Z[i]$  touches the region  $\{a \mid 0 < a < 10\}$ .
7. *Data Dependence:* To determine if the loop is parallelizable, we ask if there is a data dependence that crosses the boundary of each iteration. For this example, we first consider the dependences of the write accesses in the loop. Since the access function  $Z[z + 10]$  maps different iterations to different array locations, there are no dependences regarding the order in which the various iterations write values to the array. Is there a dependence between the read and write accesses? Since only  $Z[10], Z[11], \dots, Z[19]$  are written (by the access  $Z[i + 10]$ ), and only  $Z[0], Z[1], \dots, Z[9]$  are read (by the access  $Z[i]$ ), there can be no dependencies regarding the relative order of a read and a write. Therefore, this loop is parallelizable. That

is, each iteration of the loop is independent of all other iterations, and we can execute the iterations in parallel, or in any order we choose. Notice, however, that if we made a small change, say by increasing the upper limit on loop index  $i$  to 10 or more, then there would be dependencies, as some elements of array  $Z$  would be written on one iteration and then read 10 iterations later. In that case, the loop could not be parallelized completely, and we would have to think carefully about how iterations were partitioned among processors and how we ordered iterations.

•

Formulating the problem in terms of multidimensional spaces and affine mappings between these spaces lets us use standard mathematical techniques to solve the parallelization and locality optimization problem generally. For example, the region of data accessed can be found by the elimination of variables using the Fourier-Motzkin elimination algorithm. Data dependence is shown to be equivalent to the problem of integer linear programming. Finally, finding the affine partitioning corresponds to solving a set of linear constraints. Don't worry if you are not familiar with these concepts, as they will be explained starting in Section 11.3.

## 11.2 Matrix Multiply: An In-Depth Example

We shall introduce many of the techniques used by parallel compilers in an extended example. In this section, we explore the familiar matrix-multiplication algorithm to show that it is nontrivial to optimize even a simple and easily parallelizable program. We shall see how rewriting the code can improve data locality; that is, processors are able to do their work with far less communication (with global memory or with other processors, depending on the architecture) than if the straightforward program is chosen. We shall also discuss how cognizance of the existence of cache lines that hold several consecutive data elements can improve the running time of programs such as matrix multiplication.

### 11.2.1 The Matrix-Multiplication Algorithm

In Fig. 11.5 we see a typical matrix-multiplication program.<sup>2</sup> It takes two  $n \times n$  matrices,  $X$  and  $F$ , and produces their product in a third  $n \times n$  matrix  $Z$ . Recall that  $Z[i,j]$  — the element of matrix  $Z$  in row  $i$  and column  $j$  — must become  $Z[i,j] = \sum_k X[i,k]F[k,j]$ .

The code of Fig. 11.5 generates  $n^2$  results, each of which is an inner product between one row and one column of the two matrix operands. Clearly, the

<sup>2</sup>In pseudocode programs in this chapter, we shall generally use C syntax, but to make multidimensional array accesses — the central issue for most of the chapter — easier to read, we shall use Fortran-style array references, that is,  $Z[i,j]$  instead of

```

for (i = 0; i < n; i++)
  for (j = 0; j < n; j++) {
    z[i,j] = 0.0;
    for (k = 0; k < n; k++)
      z[i,j] = z[i,j] + x[i,k]*y[k,j];
  }

```

Figure 11.5: The basic matrix-multiplication algorithm

calculations of each of the elements of  $Z$  are independent and can be executed in parallel.

The larger  $n$  is, the more times the algorithm touches each element. That is, there are  $3n^2$  locations among the three matrices, but the algorithm performs  $n^3$  operations, each of which multiplies an element of  $X$  by an element of  $Y$  and adds the product to an element of  $Z$ . Thus, the algorithm is computation-intensive and memory accesses should not, in principle, constitute a bottleneck.

### Serial Execution of the Matrix Multiplication

Let us first consider how this program behaves when run sequentially on a uniprocessor. The innermost loop reads and writes the same element of  $Z$ , and uses a row of  $X$  and a column of  $Y$ .  $Z[i,j]$  can easily be stored in a register and requires no memory accesses. Assume, without loss of generality, that the matrix is laid out in row-major order, and that  $c$  is the number of array elements in a cache line.

0 1                      n - 1

$i = 0$

Figure 11.6: The data access pattern in matrix multiply

Figure 11.6 suggests the access pattern as we execute one iteration of the outer loop of Fig. 11.5. In particular, the picture shows the first iteration, with  $i = 0$ . Each time we move from one element of the first row of  $X$  to the next,

we visit each element in a single column of  $Y$ . We see in Fig. 11.6 the assumed organization of the matrices into cache lines. That is, each small rectangle represents a cache line holding four array elements (i.e.,  $c = 4$  and  $n = 12$  in the picture).

Accessing  $X$  puts little burden on the cache. One row of  $X$  is spread among only  $n/c$  cache lines. Assuming these all fit in the cache, only  $n/c$  cache misses occur for a fixed value of index  $i$ , and the total number of misses for all of  $X$  is  $n^2/c$ , the minimum possible (we assume  $n$  is divisible by  $c$ , for convenience).

However, while using one row of  $X$ , the matrix-multiplication algorithm accesses all the elements of  $Y$ , column by column. That is, when  $j = 0$ , the inner loop brings to the cache the entire first column of  $Y$ . Notice that the elements of that column are stored among  $n$  different cache lines. If the cache is big enough (or  $n$  small enough) to hold  $n$  cache lines, and no other uses of the cache force some of these cache lines to be expelled, then the column for  $j = 0$  will still be in the cache when we need the second column of  $Y$ . In that case, there will not be another  $n$  cache misses reading  $Y$ , until  $j = c$ , at which time we need to bring into the cache an entirely different set of cache lines for  $Y$ . Thus, to complete the first iteration of the outer loop (with  $i = 0$ ) requires between  $n^2/c$  and  $n^2$  cache misses, depending on whether columns of cache lines can survive from one iteration of the second loop to the next.

Moreover, as we complete the outer loop, for  $i = 1, 2$ , and so on, we may have many additional cache misses as we read  $Y$ , or none at all. If the cache is big enough that all  $n^2/c$  cache lines holding  $Y$  can reside together in the cache, then we need no more cache misses. The total number of cache misses is thus  $2n^2/c$ , half for  $X$  and half for  $Y$ . However, if the cache can hold one column of  $Y$  but not all of  $Y$ , then we need to bring all of  $Y$  into cache again, each time we perform an iteration of the outer loop. That is, the number of cache misses is  $n^2/c + n^2/c$ ; the first term is for  $X$  and the second is for  $Y$ . Worst, if we cannot even hold one column of  $Y$  in the cache, then we have  $n^2$  cache misses per iteration of the outer loop and a total of  $n^2/c + n^2$  cache misses.

### Row-by-Row Parallelization

Now, let us consider how we could use some number of processors, say  $p$  processors, to speed up the execution of Fig. 11.5. An obvious approach to parallelizing matrix multiplication is to assign different rows of  $Z$  to different processors. A processor is responsible for  $n/p$  consecutive rows (we assume  $n$  is divisible by  $p$ , for convenience). With this division of labor, each processor needs to access  $n/p$  rows of matrices  $X$  and  $Z$ , but the entire  $Y$  matrix. One processor will compute  $n^2/p$  elements of  $Z$ , performing  $n^2/p$  multiply-and-add operations to do so.

While the computation time thus decreases in proportion to  $p$ , the communication cost actually rises in proportion to  $p$ . That is, each of  $p$  processors has to read  $n^2/p$  elements of  $X$ , but all  $n^2$  elements of  $Y$ . The total number of cache lines that must be delivered to the caches of the  $p$  processors is at last

$n^2/c + pn^2/c$ ; the two terms are for delivering  $X$  and copies of  $Y$ , respectively. As  $p$  approaches  $n$ , the computation time becomes  $O(n^2)$  while the communication cost is  $O(n^3)$ . That is, the bus on which data is moved between memory and the processors' caches becomes the bottleneck. Thus, with the proposed data layout, using a large number of processors to share the computation can actually slow down the computation, rather than speed it up.

### 11.2.2 Optimizations

The matrix-multiplication algorithm of Fig. 11.5 shows that even though an algorithm may *reuse* the same data, it may have poor data locality. A reuse of data results in a cache hit only if the reuse happens soon enough, before the data is displaced from the cache. In this case,  $n^2$  multiply-add operations separate the reuse of the same data element in matrix  $Y$ , so locality is poor. In fact,  $n$  operations separate the reuse of the same cache line in  $Y$ . In addition, on a multiprocessor, reuse may result in a cache hit only if the data is reused by the same processor. When we considered a parallel implementation in Section 11.2.1, we saw that elements of  $Y$  had to be used by every processor. Thus, the reuse of  $Y$  is not turned into locality.

#### Changing Data Layout

One way to improve the locality of a program is to change the layout of its data structures. For example, storing  $Y$  in column-major order would have improved the reuse of cache lines for matrix  $Y$ . The applicability of this approach is limited, because the same matrix normally is used in different operations. If  $Y$  played the role of  $X$  in another matrix multiplication, then it would suffer from being stored in column-major order, since the first matrix in a multiplication is better stored in row-major order.

#### Blocking

It is sometimes possible to change the execution order of the instructions to improve data locality. The technique of interchanging loops, however, does not improve the matrix-multiplication routine. Suppose the routine were written to generate a column of matrix  $Z$  at a time, instead of a row at a time. That is, make the  $j$ -loop the outer loop and the  $z$ -loop the second loop. Assuming matrices are still stored in row-major order, matrix  $Y$  enjoys better spatial and temporal locality, but only at the expense of matrix  $X$ .

*Blocking* is another way of reordering iterations in a loop that can greatly improve the locality of a program. Instead of computing the result a row or a column at a time, we divide the matrix up into submatrices, or *blocks*, as suggested by Fig. 11.7, and we order operations so an entire block is used over a short period of time. Typically, the blocks are squares with a side of length  $B$ . If  $B$  evenly divides  $n$ , then all the blocks are square. If  $B$  does not evenly



divide  $n$ , then the blocks on the lower and right edges will have one or both sides of length less than  $B$ .

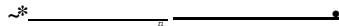

Figure 11.7: A matrix divided into blocks of side  $B$

Figure 11.8 shows a version of the basic matrix-multiplication algorithm where all three matrices have been blocked into squares of side  $B$ . As in Fig. 11.5,  $Z$  is assumed to have been initialized to all O's. We assume that  $B$  divides  $n$ ; if not, then we need to modify line (4) so the upper limit is  $\min(u + B, n)$ , and similarly for lines (5) and (6).

```

1) for (ii = 0; ii < n; ii = ii+B)
2)   for (jj = 0; jj < n; jj = jj+B)
3)     for (kk = 0; kk < n; kk = kk+B)
4)       for (i = ii; i < ii+B; i++)
5)         for (j = jj; j < jj+B; j++)
6)           for (k = kk; k < kk+B; k++)
7)             Z[i,j] = Z[i,j] + X[i,k]*Y[k,j];

```

Figure 11.8: Matrix multiplication with blocking

The outer three loops, lines (1) through (3), use indexes  $ii$ ,  $jj$ , and  $kk$ , which are always incremented by  $B$ , and therefore always mark the left or upper edge of some blocks. With fixed values of  $ii$ ,  $jj$ , and  $kk$ , lines (4) through (7) enable the blocks with upper-left corners  $X[ii,kk]$  and  $Y[kk,jj]$  to make all possible contributions to the block with upper-left corner  $Z[ii,jj]$ .

If we pick  $B$  properly, we can significantly decrease the number of cache misses, compared with the basic algorithm, when all of  $X$ ,  $Y$ , or  $Z$  cannot fit in the cache. Choose  $B$  such that it is possible to fit one block from each of the matrices in the cache. Because of the order of the loops, we actually need each

### Another View of Block-Based Matrix Multiplication

We can imagine that the matrices  $X, Y$ , and  $Z$  of Fig. 11.8 are not  $n \times n$  matrices of floating-point numbers, but rather  $(n/B) \times (n/B)$  matrices whose elements are themselves  $B \times B$  matrices of floating-point numbers. Lines (1) through (3) of Fig. 11.8 are then like the three loops of the basic algorithm in Fig. 11.5, but with  $n/B$  as the size of the matrices, rather than  $n$ . We can then think of lines (4) through (7) of Fig. 11.8 as implementing a single multiply-and-add operation of Fig. 11.5. Notice that in this operation, the single multiply step is a matrix-multiply step, and it uses the basic algorithm of Fig. 11.5 on the floating-point numbers that are elements of the two matrices involved. The matrix addition is element-wise addition of floating-point numbers.

block of  $Z$  in cache only once, so (as in the analysis of the basic algorithm in Section 11.2.1) we shall not count the cache misses due to  $Z$ .

To bring a block of  $X$  or  $Y$  to the cache takes  $B^2/c$  cache misses; recall  $c$  is the number of elements in a cache line. However, with fixed blocks from  $X$  and  $Y$ , we perform  $B^2$  multiply-and-add operations in lines (4) through (7) of Fig. 11.8. Since the entire matrix-multiplication requires  $n^3$  multiply-and-add operations, the number of times we need to bring a pair of blocks to the cache is  $n^3/B^2$ . As we require  $2B^2/c$  cache misses each time we do, the total number of cache misses is  $2n^3/Bc$ .

It is interesting to compare this figure  $2n^3/Bc$  with the estimates given in Section 11.2.1. There, we said that if entire matrices can fit in the cache, then  $O(n^2/c)$  cache misses suffice. However, in that case, we can pick  $B = n$ , i.e., make each matrix be a single block. We again get  $O(n^2/c)$  as our estimate of cache misses. On the other hand, we observed that if entire matrices will not fit in cache, we require  $O(n^3/c)$  cache misses, or even  $O(n^3)$  cache misses. In that case, assuming that we can still pick a significantly large  $B$  (e.g.,  $B$  could be 200, and we could still fit three blocks of 8-byte numbers in a one-megabyte cache), there is a great advantage to using blocking in matrix multiplication.

The blocking technique can be reapplied for each level of the memory hierarchy. For example, we may wish to optimize register usage by holding the operands of a  $2 \times 2$  matrix multiplication in registers. We choose successively bigger block sizes for the different levels of caches and physical memory.

Similarly, we can distribute blocks between processors to minimize data traffic. Experiments showed that such optimizations can improve the performance of a uniprocessor by a factor of 3, and the speed up on a multiprocessor is close to linear with respect to the number of processors used.

### 11.2.3 Cache Interference

Unfortunately, there is somewhat more to the story of cache utilization. Most caches are not fully associative (see Section 7.4.2). In a direct-mapped cache, if  $n$  is a multiple of the cache size, then all the elements in the same row of an  $n \times n$  array will be competing for the same cache location. In that case, bringing in the second element of a column will throw away the cache line of the first, even though the cache has the capacity to keep both of these lines at the same time. This situation is referred to as *cache interference*.

There are various solutions to this problem. The first is to rearrange the data once and for all so that the data accessed is laid out in consecutive data locations. The second is to embed the  $n \times n$  array in a larger  $m \times n$  array where  $m$  is chosen to minimize the interference problem. Third, in some cases we can choose a block size that is guaranteed to avoid interference.

### 11.2.4 Exercises for Section 11.2

**Exercise 11.2.1:** The block-based matrix-multiplication algorithm of Fig. 11.8 does not have the initialization of the matrix  $Z$  to zero, as the code of Fig. 11.5 does. Add the steps that initialize  $Z$  to all zeros in Fig. 11.8.

## 11.3 Iteration Spaces

The motivation for this study is to exploit the techniques that, in simple settings like matrix multiplication as in Section 11.2, were quite straightforward. In the more general setting, the same techniques apply, but they are far less intuitive. But by applying some linear algebra, we can make everything work in the general setting.

As discussed in Section 11.1.5, there are three kinds of spaces in our transformation model: iteration space, data space, and processor space. Here we start with the iteration space. The iteration space of a loop nest is defined to be all the combinations of loop-index values in the nest.

Often, the iteration space is rectangular, as in the matrix-multiplication example of Fig. 11.5. There, each of the nested loops had a lower bound of  $0$  and an upper bound of  $n - 1$ . However, in more complicated, but still quite realistic, loop nests, the upper and/or lower bounds on one loop index can depend on the values of the indexes of the outer loops. We shall see an example shortly.

### 11.3.1 Constructing Iteration Spaces from Loop Nests

To begin, let us describe the sort of loop nests that can be handled by the techniques to be developed. Each loop has a single loop index, which we assume is incremented by  $1$  at each iteration. That assumption is without loss of generality, since if the incrementation is by integer  $c > 1$ , we can always replace

uses of the index  $i$  by uses of  $ci + a$  for some positive or negative constant  $a$ , and then increment  $i$  by 1 in the loop. The bounds of the loop should be written as affine expressions of outer loop indices.

**Example 11.5 :** Consider the loop

```
for (i = 2; i <= 100; i = i+3)
    Z[i] = 0;
```

which increments  $i$  by 3 each time around the loop. The effect is to set to 0 each of the elements  $Z[2], Z[5], Z[8], \dots, Z[98]$ . We can get the same effect with:

```
for (j = 0; j <= 32; j++)
    Z[3*j+2] = 0;
```

That is, we substitute  $3j + 2$  for  $i$ . The lower limit  $i = 2$  becomes  $j = 0$  (just solve  $3j + 2 = 2$  for  $j$ ), and the upper limit  $i < 100$  becomes  $j < 32$  (simplify  $3j + 2 < 100$  to get  $j < 32.67$  and round down because  $j$  has to be an integer).

•

Typically, we shall use for-loops in loop nests. A while-loop or repeat-loop can be replaced by a for-loop if there is an index and upper and lower bounds for the index, as would be the case in something like the loop of Fig. 11.9(a). A for-loop like for ( $i=0; i<100; i++$ ) serves exactly the same purpose.

However, some while- or repeat-loops have no obvious limit. For example, Fig. 11.9(b) may or may not terminate, but there is no way to tell what condition on  $i$  in the unseen body of the loop causes the loop to break. Figure 11.9(c) is another problem case. Variable  $n$  might be a parameter of a function, for example. We know the loop iterates  $n$  times, but we don't know what  $n$  is at compile time, and in fact we may expect that different executions of the loop will execute different numbers of times. In cases like (b) and (c), we must treat the upper limit on  $i$  as infinity.

A  $d$ -deep loop nest can be modeled by a  $d$ -dimensional space. The dimensions are ordered, with the  $k$ th dimension representing the  $k$ th nested loop, counting from the outermost loop, inward. A point  $(x_1, x_2, \dots, x_d)$  in this space represents values for all the loop indexes; the outermost loop index has value  $x_1$ , the second loop index has value  $x_2$ , and so on. The innermost loop index has value  $x_d$ .

But not all points in this space represent combinations of indexes that actually occur during execution of the loop nest. As an affine function of outer loop indices, each lower and upper loop bound defines an inequality dividing the iteration space into two half spaces: those that are iterations in the loop (the *positive* half space), and those that are not (the *negative* half space). The conjunction (logical AND) of all the linear equalities represents the intersection of the positive half spaces, which defines a convex polyhedron, which we call the *iteration space* for the loop nest. A *convex polyhedron* has the property that if

```

i = 0;
while (i<100) {
    <some statements not involving i>
    i = i+1;
}

```

(a) A while-loop with obvious limits.

```

i = 0;
while (1) {
    <some statements>
    i = i+1;
}

```

(b) It is unclear when or if this loop terminates.

```

i = 0;
while (i<n) {
    <some statements not involving i or n>
    i = i+1;
}

```

(c) We don't know the value of  $n$ , so we don't know when this loop terminates.

Figure 11.9: Some while-loops

two points are in the polyhedron, all points on the line between them are also in the polyhedron. All the iterations in the loop are represented by the points with integer coordinates found within the polyhedron described by the loop-bound inequalities. And conversely, all integer points within the polyhedron represent iterations of the loop nest at some time.

```

for (i = 0; i <= 5; i++)
    for (j = i; j <= 7; j++)
        Z[j,i] = 0;

```

Figure 11.10: A 2-dimensional loop nest

**Example 11.6:** Consider the 2-dimensional loop nest in Fig. 11.10. We can model this two-deep loop nest by the 2-dimensional polyhedron shown in Fig. 11.11. The two axes represent the values of the loop indexes  $i$  and  $j$ . Index  $i$  can take on any integral value between 0 and 5; index  $j$  can take on any integral value such that  $i < j < 7$ . •

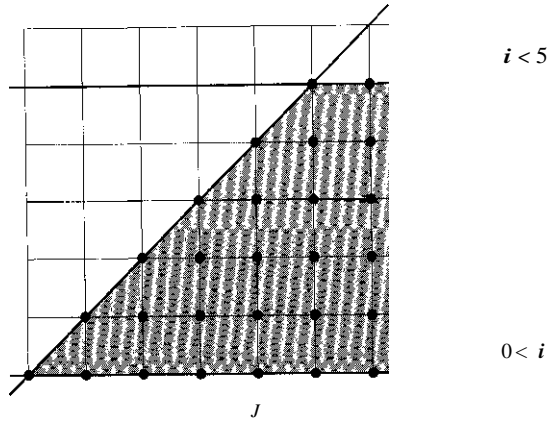

Figure 11.11: The iteration space of Example 11.6

### Iteration Spaces and Array-Accesses

In the code of Fig. 11.10, the iteration space is also the portion of the array  $A$  that the code accesses. That sort of access, where the array indexes are also loop indexes in some order, is very common. However, we should not confuse the space of iterations, whose dimensions are loop indexes, with the data space. If we had used in Fig. 11.10 an array access like  $A[2*i, i+j]$  instead of  $A[i, j]$ , the difference would have been apparent.

#### 11.3.2 Execution Order for Loop Nests

A sequential execution of a loop nest sweeps through iterations in its iteration space in an ascending lexicographic order. A vector  $i = [i_0, i_1, \dots, i_n]$  is *lexicographically less than* another vector  $i' = [i'_0, \dots, i'_n]$ , written  $i < i'$ , if and only if there exists an  $m < \min(n, n')$  such that  $[i_0, i_1, \dots, i_m] = [i'_0, i'_1, \dots, i'_m]$  and  $i_{m+1} < i'_{m+1}$ . Note that  $m = 0$  is possible, and in fact common.

Example 11.7: With  $i$  as the outer loop, the iterations in the loop nest in Example 11.6 are executed in the order shown in Fig. 11.12. •

#### 11.3.3 Matrix Formulation of Inequalities

The iterations in a  $d$ -deep loop can be represented mathematically as

$$\{i \text{ in } \mathbf{Z}^d \mid \mathbf{B}i + \mathbf{b} > \mathbf{0}\} \tag{11.1}$$

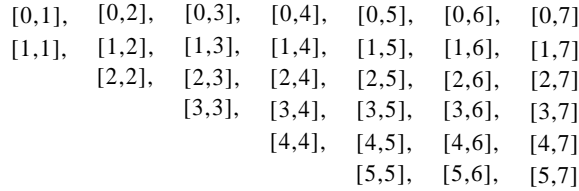

Figure 11.12: Iteration order for loop nest of Fig. 11.10

Here,

1.  $Z$ , as is conventional in mathematics, represents the set of integers — positive, negative, and zero,
2.  $B$  is a  $d \times d$  integer matrix,
3.  $b$  is an integer vector of length  $d$ , and
4.  $\mathbf{0}$  is a vector of  $d$  0's.

Example 11.8 : We can write the inequalities of Example 11.6 as in Fig. 11.13. That is, the range of  $i$  is described by  $i > 0$  and  $i < 5$ ; the range of  $j$  is described by  $j > i$  and  $j < 7$ . We need to put each of these inequalities in the form  $ui + vj + w > 0$ . Then,  $[w, v]$  becomes a row of the matrix  $B$  in the inequality (11.1), and  $w$  becomes the corresponding component of the vector  $b$ . For instance,  $i > 0$  is of this form, with  $u = 1$ ,  $v = 0$ , and  $w = 0$ . This inequality is represented by the first row of  $B$  and top element of  $b$  in Fig. 11.13.

$$\begin{pmatrix} 1 & 0 \\ -1 & 0 \\ -1 & 1 \\ 0 & -1 \end{pmatrix} \begin{pmatrix} i \\ j \end{pmatrix} + \begin{pmatrix} 0 \\ 5 \\ 0 \\ 7 \end{pmatrix} > \begin{pmatrix} 0 \\ 0 \\ 0 \\ 0 \end{pmatrix}$$

Figure 11.13: Matrix-vector multiplication and a vector inequality represents the inequalities defining an iteration space

As another example, the inequality  $i < 5$  is equivalent to  $(-1)i + (0)j + 5 > 0$ , and is represented by the second row of  $B$  and  $b$  in Fig. 11.13. Also,  $j > i$  becomes  $(-1)i + (1)j + 0 > 0$  and is represented by the third row. Finally,  $j < 7$  becomes  $(0)i + (-1)j + 7 > 0$  and is the last row of the matrix and vector. •

## Manipulating Inequalities

To convert inequalities, as in Example 11.8, we can perform transformations much as we do for equalities, e.g., adding or subtracting from both sides, or multiplying both sides by a constant. The only special rule we must remember is that when we multiply both sides by a negative number, we have to reverse the direction of the inequality. Thus,  $i < 5$ , multiplied by  $-1$ , becomes  $-i > -5$ . Adding 5 to both sides, gives  $-i + 5 > 0$ , which is essentially the second row of Fig. 11.13.

### 11.3.4 Incorporating Symbolic Constants

Sometimes, we need to optimize a loop nest that involves certain variables that are loop-invariant for all the loops in the nest. We call such variables *symbolic constants*, but to describe the boundaries of an iteration space we need to treat them as variables and create an entry for them in the vector of loop indexes, i.e., the vector  $\mathbf{i}$  in the general formulation of inequalities (11.1).

Example 11.9 : Consider the simple loop:

```
for (i = 0; i <= n; i++) {
    }

```

This loop defines a one-dimensional iteration space, with index  $i$ , bounded by  $i > 0$  and  $i < n$ . Since  $n$  is a symbolic constant, we need to include it as a variable, giving us a vector of loop indexes  $[i, n]$ . In matrix-vector form, this iteration space is defined by

$$\begin{vmatrix} -1 & 1 \\ 1 & 0 \end{vmatrix} \begin{vmatrix} i \\ n \end{vmatrix} > \begin{vmatrix} 0 \\ 0 \end{vmatrix}$$

Notice that, although the vector of array indexes has two dimensions, only the first of these, representing  $i$ , is part of the output — the set of points lying with the iteration space. •

### 11.3.5 Controlling the Order of Execution

The linear inequalities extracted from the lower and upper bounds of a loop body define a set of iterations over a convex polyhedron. As such, the representation assumes no execution ordering between iterations within the iteration space. The original program imposes one sequential order on the iterations, which is the lexicographic order with respect to the loop index variables ordered from the outermost to the innermost. However, the iterations in the space can be executed in any order as long as their data dependences are honored (i.e.,



the order in which writes and reads of any array element are performed by the various assignment statements inside the loop nest do not change).

The problem of how we choose an ordering that honors the data dependences and optimizes for data locality and parallelism is hard and is dealt with later starting from Section 11.7. Here we assume that a legal and desirable ordering is given, and show how to generate code that enforce the ordering. Let us start by showing an alternative ordering for Example 11.6.

**Example 11.10:** There are no dependences between iterations in the program in Example 11.6. We can therefore execute the iterations in arbitrary order, sequentially or concurrently. Since iteration  $(j, i)$  accesses element  $Z[j, i]$  in the code, the original program visits the array in the order of Fig. 11.14(a). To improve spatial locality, we prefer to visit contiguous words in the array consecutively, as in Fig. 11.14(b).

This access pattern is obtained if we execute the iterations in the order shown in Fig. 11.14(c). That is, instead of sweeping the iteration space in Fig. 11.11 horizontally, we sweep the iteration space vertically, so  $j$  becomes the index of the outer loop. The code that executes the iterations in the above order is

```
for (j = 0; j <= 7;
    for (i = 0; i <= min(5,j); i++)
        Z[j,i] = 0;
```

•

Given a convex polyhedron and an ordering of the index variables, how do we generate the loop bounds that sweep through the space in lexicographic order of the variables? In the example above, the constraint  $i < j$  shows up as a lower bound for index  $j$  in the inner loop in the original program, but as an upper bound for index  $i$ , again in the inner loop, in the transformed program.

The bounds of the outermost loop, expressed as linear combinations of symbolic constants and constants, define the range of all the possible values it can take on. The bounds for inner loop variables are expressed as linear combinations of outer loop index variables, symbolic constants and constants. They define the range the variable can take on for each combination of values in outer loop variables.

### Projection

Geometrically speaking, we can find the loop bounds of the outer loop index in a two-deep loop nest by *projecting* the convex polyhedron representing the iteration space onto the outer dimension of the space. The projection of a polyhedron on a lower-dimensional space is intuitively the shadow cast by the object onto that space. The projection of the two-dimensional iteration space in Fig. 11.11 onto the  $i$  axis is the vertical line from 0 to 5; and the projection onto

Z[0,0],	Z[1,0],	Z[2,0],	Z[3,0],	Z[4,0],	Z[5,0],	Z[6,0],	Z[7,0]
	Z[1,1],	Z[2,1],	Z[3,1],	Z[4,1],	Z[5,1],	Z[6,1],	Z[1,7]
		Z[2,2],	Z[3,2],	Z[4,2],	Z[5,2],	Z[6,2],	Z[7,2]
			Z[3,3],	Z[4,3],	Z[5,3],	Z[6,3],	Z[7,3]
				Z[4,4],	Z[5,4],	Z[6,4],	Z[7,4]
					Z[5,5],	Z[6,5],	Z[7,5]

(a) Original access order.

Z[0,0]							
Z[1,0],	Z[1,1]						
Z[2,0],	Z[2,1],	Z[2,2]					
Z[3,0],	Z[3,1],	Z[3,2],	Z[3,3]				
Z[4,0],	Z[4,1],	Z[4,2],	Z[4,3],	Z[4,4]			
Z[5,0],	Z[5,1],	Z[5,2],	Z[5,3],	Z[5,4],	Z[5,5]		
Z[6,0],	Z[6,1],	Z[6,2],	Z[6,3],	Z[6,4],	Z[6,5]		
Z[7,0],	Z[7,1],	Z[7,2],	Z[7,3],	Z[7,4],	Z[7,5]		

(b) Preferred order of access.

[0,0]							
[0,1],	[1,1]						
[0,2],	[1,2],	[2,2]					
[0,3],	[1,3],	[2,3],	[3,3]				
[0,4],	[1,4],	[2,4],	[3,4],	[4,4]			
[0,5],	[1,5],	[2,5],	[3,5],	[4,5],	[5,5]		
[0,6],	[1,6],	[2,6],	[3,6],	[4,6],	[5,6]		
[0,7],	[1,7],	[2,7],	[3,7],	[4,7],	[5,7]		

(c) Preferred order of iterations.

Figure 11.14: Reordering the accesses and iterations for a loop nest

the  $j$  axis is the horizontal line from 0 to 7. When we project a 3-dimensional object along the  $z$  axis onto a 2-dimensional  $x$  and  $y$  plane, we eliminate variable  $z$ , losing the height of the individual points and simply record the 2-dimensional footprint of the object in the  $x$ - $y$  plane.

Loop bound generation is only one of the many uses of projection. Projection can be defined formally as follows. Let  $S$  be an  $n$ -dimensional polyhedron. The projection of  $S$  onto the first  $m$  of its dimensions is the set of points  $(x_1, x_2, \dots, x_m)$  such that for some  $x_{m+1}, x_{m+2}, \dots, x_n$  vector  $[x_1, x_2, \dots, x_n]$  is in  $S$ . We can compute projection using *Fourier-Motzkin elimination*, as follows:

**Algorithm 11.11:** Fourier-Motzkin elimination.

**INPUT:** A polyhedron  $S$  with variables  $x_1, \dots, x_n$ . That is,  $S$  is a set of linear constraints involving the variables  $x_i$ . One given variable  $x_m$  is specified to be the variable to be eliminated.

**OUTPUT:** A polyhedron  $S'$  with variables  $x_1, \dots, x_{m-1}, x_{m+1}, \dots, x_n$  (i.e., all the variables of  $S$  except for  $x_m$ ) that is the projection of  $S$  onto dimensions other than the  $m$ th.

**METHOD:** Let  $C$  be all the constraints in  $S$  involving  $x_m$ . Do the following:

1. For every pair of a lower bound and an upper bound on  $x_m$  in  $C$ , such as

$$\begin{aligned} L &< c_1 x_m \\ c_2 x_m &< U \end{aligned}$$

create the new constraint

$$c_1 L < c_2 U$$

Note that  $c_1$  and  $c_2$  are integers, but  $L$  and  $U$  may be expressions with variables other than  $x_m$ .

2. If integers  $c_1$  and  $c_2$  have a common factor, divide both sides by that factor.
3. If the new constraint is not satisfiable, then there is no solution to  $S$ ; i.e., the polyhedra  $S$  and  $S'$  are both empty spaces.
4.  $S'$  is the set of constraints  $S - C$ , plus all the constraints generated in step 2.

Note, incidentally, that if  $x_m$  has  $u$  lower bounds and  $v$  upper bounds, eliminating  $x_m$  produces up to  $uv$  inequalities, but no more. •

The constraints added in step (1) of Algorithm 11.11 correspond to the implications of constraints  $C$  on the remaining variables in the system. Therefore, there is a solution in  $S'$  if and only if there exists at least one corresponding

solution in  $S$ . Given a solution in  $S'$  the range of the corresponding  $x_i$  can be found by replacing all variables but  $x_i$  in the constraints  $C$  by their actual values.

**Example 11.12 :** Consider the inequalities defining the iteration space in Fig. 11.11. Suppose we wish to use Fourier-Motzkin elimination to project the two-dimensional space away from the  $i$  dimension and onto the  $j$  dimension. There is one lower bound on  $i$ :  $0 < i$  and two upper bounds:  $i < j$  and  $i < 5$ . This generates two constraints:  $0 < j$  and  $0 < 5$ . The latter is trivially true and can be ignored. The former gives the lower bound on  $j$ , and the original upper bound  $j < 7$  gives the upper bound. •

### Loop-Bounds Generation

Now that we have defined Fourier-Motzkin elimination, the algorithm to generate the loop bounds to iterate over a convex polyhedron (Algorithm 11.13) is straightforward. We compute the loop bounds in order, from the innermost to the outer loops. All the inequalities involving the innermost loop index variables are written as the variable's lower or upper bounds. We then project away the dimension representing the innermost loop and obtain a polyhedron with one fewer dimension. We repeat until the bounds for all the loop index variables are found.

**Algorithm 11.13:** Computing bounds for a given order of variables.

**INPUT:** A convex polyhedron  $S$  over variables  $v_1, \dots, v_n$ .

**OUTPUT:** A set of lower bounds  $L_i$  and upper bounds  $U_i$  for each  $v_i$ , expressed only in terms of the  $v_j$ 's, for  $j < i$ .

**METHOD:** The algorithm is described in Fig. 11.15. •

**Example 11.14:** We apply Algorithm 11.13 to generate the loop bounds that sweep the iteration space of Fig. 11.11 vertically. The variables are ordered  $j, i$ . The algorithm generates these bounds:

$$\begin{array}{l|l} L_i & 0 \\ U_i & 5, j \\ L_j & 0 \\ & 7 \end{array}$$

We need to satisfy all the constraints, thus the bound on  $i$  is  $\min(5, j)$ . There are no redundancies in this example. •

```

Si = S; /* Use Algorithm 11.11 to find the bounds */
for ( i = n; i > 1; i—— ) {
    Lv = all the lower bounds on vi in Sf;
    Uv = all the upper bounds on vi in Si;
    Si-i = Constraints returned by applying Algorithm 11.11
           to eliminate Vi from the constraints Sf;
}
/* Remove redundancies */
S' = 0;
for ( i = 1; i < n; i + + ) {
    Remove any bounds in Lv and Uv implied by S';
    Add the remaining constraints of Lv and Uv on vi to S'';
}

```

Figure 11.15: Code to express variable bounds with respect to a given variable ordering

[0,0],	[1,1],	[2,2],	[3,3],	[4,4],	[5,5]
[0,1],	[1,2],	[2,3],	[3,4],	[4,5],	[5,6]
[0,2],	[1,3],	[2,4],	[3,5],	[4,6],	[5,7]
[0,3],	[1,4],	[2,5],	[3,6],	[4,7]	
[0,4],	[1,5],	[2,6],	[3,7]		
[0,5],	[1,6],	[2,7]			
[0,6],	[1,7]				
[0,7]					

Figure 11.16: Diagonalwise ordering of the iteration space of Fig. 11.11

### 11.3.6 Changing Axes

Note that sweeping the iteration space horizontally and vertically, as discussed above, are just two of the most common ways of visiting the iteration space. There are many other possibilities; for example, we can sweep the iteration space in Example 11.6 diagonal by diagonal, as discussed below in Example 11.15.

Example 11.15: We can sweep the iteration space shown in Fig. 11.11 diagonally using the order shown in Fig. 11.16. The difference between the coordinates  $j$  and  $i$  in each diagonal is a constant, starting with 0 and ending with 7. Thus, we define a new variable  $k = j - i$  and sweep through the iteration space in lexicographic order with respect to  $k$  and  $j$ . Substituting  $i = j - k$  in the inequalities we get:

To create the loop bounds for the order described above, we can apply Algorithm 11.13 to the above set of inequalities with variable ordering  $k, j$ .

$$\begin{array}{ll} L_j \setminus & k \\ U_j \setminus & 5 + k, 7 \\ L_i & 0 \\ U_i & 7 \end{array}$$

From these inequalities, we generate the following code, replacing  $i$  by  $j - k$  in array accesses.

```
for (k = 0; k <= 7; k++)
  for (j = k; j <= min(5+k,7); j++)
    Z[j,j-k] = 0;
```

•

In general, we can change the axes of a polyhedron by creating new loop index variables that represent **affine** combinations of the original variables, and defining an ordering on those variables. The hard problem lies in choosing the right axes to satisfy the data dependences while achieving the parallelism and locality objectives. We discuss this problem starting with Section 11.7. What we have established here is that once the axes are chosen, it is straightforward to generate the desired code, as shown in Example 11.15.

There are many other iteration-traversal orders not handled by this technique. For example, we may wish to visit all the odd rows in an iteration space before we visit the even rows. Or, we may want to start with the iterations in the middle of the iteration space and progress to the fringes. For applications that have affine access functions, however, the techniques described here cover most of the desirable iteration orderings.

### 11.3.7 Exercises for Section 11.3

Exercise 11.3.1: Convert each of the following loops to a form where the loop indexes are each incremented by 1:

- for ( $i=10$ ;  $i<50$ ;  $i=i+7$ )  $X[i,i+1] = 0$ ;
- for ( $i= -3$ ;  $i<=10$ ;  $i=i+2$ )  $X[i] = x[i+1]$ ;
- for ( $i=50$ ;  $i>=10$ ;  $i--$ )  $X[i] = 0$ ;

Exercise 11.3.2: Draw or describe the iteration spaces for each of the following loop nests:

- The loop nest of Fig. 11.17(a).
- The loop nest of Fig. 11.17(b).

```

for (i = 1; i < 30; i++)
  for (j = i+2; j < 40-1; j++)
    X[i,j] = 0;

```

(a) Loop nest for Exercise 11.3.2(a).

```

for (i = 10; i <= 1000; i++)
  for (j = i; j < i+10; j++)
    X[i,j] = 0;

```

(b) Loop nest for Exercise 11.3.2(b).

```

for (i = 0; i < 100; i++)
  for (j = 0; j < 100+i; j++)
    for (k = i+j; k < 100-i-j; k++)
      X[i,j,k] = 0;

```

(c) Loop nest for Exercise 11.3.2(c).

Figure 11.17: Loop nests for Exercise 11.3.2

c) The loop nest of Fig. 11.17(c).

**Exercise 11.3.3:** Write the constraints implied by each of the loop nests of Fig. 11.17 in the form of (11.1). That is, give the values of the vectors  $\mathbf{i}$  and  $\mathbf{b}$  and the matrix  $\mathbf{B}$ .

**Exercise 11.3.4:** Reverse each of the loop-nesting orders for the nests of Fig. 11.17.

**Exercise 11.3.5:** Use the Fourier-Motzkin elimination algorithm to eliminate  $i$  from each of the sets of constraints obtained in Exercise 11.3.3.

**Exercise 11.3.6:** Use the Fourier-Motzkin elimination algorithm to eliminate  $j$  from each of the sets of constraints obtained in Exercise 11.3.3.

**Exercise 11.3.7:** For each of the loop nests in Fig. 11.17, rewrite the code so the axis  $i$  is replaced by the major diagonal, i.e., the direction of the axis is characterized by  $i = j$ . The new axis should correspond to the outermost loop.

**Exercise 11.3.8:** Repeat Exercise 11.3.7 for the following changes of axes:

- a) Replace  $i$  by  $i + j$ ; i.e., the direction of the axis is the lines for which  $i+j$  is a constant. The new axis corresponds to the outermost loop.
- b) Replace  $j$  by  $i - 2j$ . The new axis corresponds to the outermost loop.

**! Exercise 11.3.9:** Let  $A$ ,  $B$ , and  $C$  be integer constants in the following loop, with  $C > 1$  and  $B > A$ :

```
for (i = A; i <= B; i = i + C)
    Z[i] = 0;
```

Rewrite the loop so the incrementation of the loop variable is 1 and the initialization is to 0, that is, to be of the form

```
for (j = 0; j <= D; j++)
    Z[E*j + F] = 0;
```

for integers  $D$ ,  $E$ , and  $F$ . Express  $D$ ,  $E$ , and  $F$  in terms of  $A$ ,  $B$ , and  $C$ .

**Exercise 11.3.10:** For a generic two-loop nest

```
for (i = 0; i <= A; i++)
    for(j = B*i+C; j <= D*i+E;
```

with  $A$  through  $E$  integer constants, write the constraints that define the loop nest's iteration space in matrix-vector form, i.e., in the form  $\mathbf{B}\mathbf{i} + \mathbf{b} = \mathbf{0}$ .

**Exercise 11.3.11:** Repeat Exercise 11.3.10 for a generic two-loop nest with symbolic integer constants  $m$  and  $n$  as in

```
for (i = 0; i <= m; i++)
    for(j = A*i+B; j <= O*i+n; j++)
```

As before,  $A$ ,  $B$ , and  $C$  stand for specific integer constants. Only  $i$ ,  $j$ ,  $m$ , and  $n$  should be mentioned in the vector of unknowns. Also, remember that only  $i$  and  $j$  are output variables for the expression.

## 11.4 Affine Array Indexes

The focus of this chapter is on the class of affine array accesses, where each array index is expressed as affine expressions of loop indexes and symbolic constants. Affine functions provide a succinct mapping from the iteration space to the data space, making it easy to determine which iterations map to the same data or same cache line.

Just as the affine upper and lower bounds of a loop can be represented as a matrix-vector calculation, we can do the same for affine access functions. Once placed in the matrix-vector form, we can apply standard linear algebra to find pertinent information such as the dimensions of the data accessed, and which iterations refer to the same data.



### 11.4.1 Affine Accesses

We say that an array access in a loop is *affine* if

1. The bounds of the loop are expressed as affine expressions of the surrounding loop variables and symbolic constants, and
2. The index for each dimension of the array is also an affine expression of surrounding loop variables and symbolic constants.

**Example 11.16:** Suppose  $i$  and  $j$  are loop index variables bounded by affine expressions. Some examples of affine array accesses are  $Z[i]$ ,  $Z[i + j + 1]$ ,  $Z[0]$ ,  $Z[i, i]$ , and  $Z[2*i + 1, 3*j - 10]$ . If  $n$  is a symbolic constant for a loop nest, then  $Z[S * n, n - j]$  is another example of an affine array access. However,  $Z[i * j]$  and  $Z[n * j]$  are not affine accesses. •

Each affine array access can be described by two matrices and two vectors. The first matrix-vector pair is the  $\mathbf{B}$  and  $\mathbf{b}$  that describe the iteration space for the access, as in the inequality of Equation (11.1). The second pair, which we usually refer to as  $\mathbf{F}$  and  $\mathbf{f}$ , represent the function(s) of the loop-index variables that produce the array index(es) used in the various dimensions of the array access.

Formally, we represent an array access in a loop nest that uses a vector of index variables  $\mathbf{i}$  by the four-tuple  $T = (\mathbf{F}, \mathbf{f}, \mathbf{B} > \mathbf{b})$ ; it maps a vector  $\mathbf{i}$  within the bounds

$$\mathbf{B}\mathbf{i} + \mathbf{b} > \mathbf{0}$$

to the array element location

$$\mathbf{F}\mathbf{i} + \mathbf{f}$$

**Example 11.17:** In Fig. 11.18 are some common array accesses, expressed in matrix notation. The two loop indexes are  $i$  and  $j$ , and these form the vector  $\mathbf{i}$ . Also,  $X$ ,  $Y$ , and  $Z$  are arrays with 1, 2, and 3 dimensions, respectively.

The first access,  $A[i - 1]$ , is represented by a  $1 \times 2$  matrix  $\mathbf{F}$  and a vector  $\mathbf{f}$  of length 1. Notice that when we perform the matrix-vector multiplication and add in the vector  $\mathbf{f}$ , we are left with a single function, which is exactly the formula for the access to the one-dimensional array  $X$ . Also notice the third access,  $Y[j, j + 1]$ , which, after matrix-vector multiplication and addition, yields a pair of functions,  $(J, j + 1)$ . These are the indexes of the two dimensions of the array access.

Finally, let us observe the fourth access  $K[1, 2]$ . This access is a constant, and unsurprisingly the matrix  $\mathbf{F}$  is all 0's. Thus, the vector of loop indexes,  $\mathbf{i}$ , does not appear in the access function. •

ACCESS	AFFINE	EXPRESSION
X[i-1]	$\begin{bmatrix} 1 & 0 \end{bmatrix}$	$\begin{bmatrix} i \\ j \end{bmatrix} + \mathbf{1}_1$
Y[i,j]	$\begin{bmatrix} 1 & 0 \\ 0 & 1 \end{bmatrix}$	$\begin{bmatrix} i \\ -j \end{bmatrix} + \begin{bmatrix} 0 \\ 0 \end{bmatrix}$
Y[j,j+1]	$\begin{bmatrix} 0 & 1 \\ 0 & 1 \end{bmatrix}$	$\begin{bmatrix} i \\ j \end{bmatrix} + \begin{bmatrix} 0 \\ 1 \end{bmatrix}$
Y[1,2]	$\begin{bmatrix} 0 & 0 \\ 0 & 0 \end{bmatrix}$	$\begin{bmatrix} i \\ j \end{bmatrix} + \begin{bmatrix} 1 \\ 2 \end{bmatrix}$
	$\begin{bmatrix} 0 & 0 \\ 0 & 0 \end{bmatrix}$	$\begin{bmatrix} 1 \\ 1 \end{bmatrix}$
Z[1,i,2*i+j]	$\begin{bmatrix} 1 & 0 \\ 2 & 1 \end{bmatrix}$	$\begin{bmatrix} -j \\ - \end{bmatrix} + \begin{bmatrix} 0 \\ 0 \end{bmatrix}$

Figure 11.18: Some array accesses and their matrix-vector representations

### 11.4.2 Affine and Nonaffine Accesses in Practice

There are certain common data access patterns found in numerical programs that fail to be affine. Programs involving sparse matrices are one important example. One popular representation for sparse matrices is to store only the nonzero elements in a vector, and auxiliary index arrays are used to mark where a row starts and which columns contain nonzeros. Indirect array accesses are used in accessing such data. An access of this type, such as  $X[i-1]$  is a nonaffine access to the array  $X$ . If the sparsity is regular, as in banded matrices having nonzeros only around the diagonal, then dense arrays can be used to represent the subregions with nonzero elements. In that case, accesses may be affine.

Another common example of nonaffine accesses is linearized arrays. Programmers sometimes use a linear array to store a logically multidimensional object. One reason why this is the case is that the dimensions of the array may not be known at compile time. An access that would normally look like  $Z[i,j]$  would be expressed as  $Z[i * n + j]$ , which is a quadratic function. We can convert the linear access into a multidimensional access if every access can

be decomposed into separate dimensions with the guarantee that none of the components exceeds its bound. Finally, we note that induction-variable analyses can be used to convert some nonaffine accesses into affine ones, as shown in Example 11.18.

**Example 11.18:** We can rewrite the code

```

j = n;
for (i = 0; i <= n; i++) {
    Z[j] = 0;
    j = J+2;
}

```

as

```

j = n;
for (i = 0; i <= n; i++) {
    Z[n+2*i] = 0;
}

```

to make the access to matrix  $Z$  affine. •

### 11.4.3 Exercises for Section 11.4

**Exercise 11.4.1:** For each of the following array accesses, give the vector  $f$  and the matrix  $F$  that describe them. Assume that the vector of indexes  $i$  is  $i, j, \dots$ , and that all loop indexes have affine limits.

- $X[2*i + S, 2*j - i]$ .
- $Y[i-j, j - k, k - i]$ .
- $Z[3, 2*j, fc - 2*i + 1]$ .

## 11.5 Data Reuse

From array access functions we derive two kinds of information useful for locality optimization and parallelization:

- Data reuse:* for locality optimization, we wish to identify sets of iterations that access the same data or the same cache line.
- Data dependence:* for correctness of parallelization and locality loop transformations, we wish to identify *all* the data dependences in the code. Recall that two (not necessarily distinct) accesses have a data dependence if instances of the accesses may refer to the same memory location, and at least one of them is a write.

In many cases, whenever we identify iterations that reuse the same data, there are data dependences between them.

Whenever there is a data dependence, obviously the same data is reused. For example, in matrix multiplication, the same element in the output array is written  $O(n)$  times. The write operations must be executed in the original execution order;<sup>3</sup> there is reuse because we can allocate the same element to a register.

However, not all reuse can be exploited in locality optimizations; here is an example illustrating this issue.

**Example 11.19:** Consider the following loop:

```
for (i = 0; i < n; i++)
    Z[7i+3] = Z[3i+5];
```

We observe that the loop writes to a different location at each iteration, so there are no reuses or dependences on the different write operations. The loop, however, reads locations 5, 8, 11, 14, 17, ..., and writes locations 3, 10, 17, 24, ... The read and write iterations access the same elements 17, 38, and 59 and so on. That is, the integers of the form  $17 + 21j$  for  $j = 0, 1, 2, \dots$  are all those integers that can be written both as  $7i + 3$  and as  $3i + 5$ , for some integers  $i$  and  $i'$ . However, this reuse occurs rarely, and cannot be exploited easily if at all. •

Data dependence is different from reuse analysis in that one of the accesses sharing a data dependence must be a write access. More importantly, data dependence needs to be both correct and precise. It needs to find all dependences for correctness, and it should not find spurious dependences because they can cause unnecessary serialization.

With data reuse, we only need to find where most of the exploitable reuses are. This problem is much simpler, so we take up this topic here in this section and tackle data dependences in the next. We simplify reuse analysis by ignoring loop bounds, because they seldom change the shape of the reuse. Much of the reuse exploitable by affine partitioning resides among instances of the same array accesses, and accesses that share the same *coefficient matrix* (what we have typically called **F** in the affine index function). As shown above, access patterns like  $7i + 3$  and  $3i + 5$  have no reuse of interest.

### 11.5.1 Types of Reuse

We first start with Example 11.20 to illustrate the different kinds of data reuses. In the following, we need to distinguish between the access as an instruction in

<sup>3</sup> There is a subtle point here. Because of the commutativity of addition, we would get the same answer to the sum regardless of the order in which we performed the sum. However, this case is very special. In general, it is far too complex for the compiler to determine what computation is being performed by a sequence of arithmetic steps followed by writes, and we cannot rely on there being any algebraic rules that will help us reorder the steps safely.

a program, e.g.,  $x = Z[i, j]$ , from the execution of this instruction many times, as we execute the loop nest. For emphasis, we may refer to the statement itself as a *static access*, while the various iterations of the statement as we execute its loop nest are called *dynamic accesses*.

Reuses can be classified as *self* versus *group*. If iterations reusing the same data come from the same static access, we refer to the reuse as self reuse; if they come from different accesses, we refer to it as group reuse. The reuse is *temporal* if the same exact location is referenced; it is *spatial* if the same cache line is referenced.

Example 11.20 : Consider the following loop nest:

```
float Z[n] ;
for (i = 0; i < n; i++)
  for (j = 0; j < n; j++)
    Z[j+1] = (Z[j] + Z[j+1] + Z[j+2])/3;
```

Accesses  $Z[j]$ ,  $Z[j + 1]$ , and  $Z[j + 2]$  each have self-spatial reuse because consecutive iterations of the same access refer to contiguous array elements. Presumably contiguous elements are very likely to reside on the same cache line. In addition, they all have self-temporal reuse, since the exact elements are used over and over again in each iteration in the outer loop. In addition, they all have the same coefficient matrix, and thus have group reuse. There is group reuse, both temporal and spatial, between the different accesses. Although there are  $4n^2$  accesses in this code, if the reuse can be exploited, we only need to bring in about  $n/c$  cache lines into the cache, where  $c$  is the number of words in a cache line. We drop a factor of  $n$  due to self-spatial reuse, a factor of  $c$  due to spatial locality, and finally a factor of 4 due to group reuse. •

In the following, we show how we can use linear algebra to extract the reuse information from affine array accesses. We are interested in not just finding how much potential savings there are, but also which iterations are reusing the data so that we can try to move them close together to exploit the reuse.

### 11.5.2 Self Reuse

There can be substantial savings in memory accesses by exploiting self reuse. If the data referenced by a static access has  $k$  dimensions and the access is nested in a loop  $d$  deep, for some  $d > k$ , then the same data can be reused  $n^{d-k}$  times, where  $n$  is the number of iterations in each loop. For example, if a 3-deep loop nest accesses one column of an array, then there is a potential savings factor of  $n^2$  accesses. It turns out that the dimensionality of an access corresponds to the concept of the *rank* of the coefficient matrix in the access, and we can find which iterations refer to the same location by finding the *null space* of the matrix, as explained below.

## Rank of a Matrix

The rank of a matrix  $\mathbf{F}$  is the largest number of columns (or equivalently, rows) of  $\mathbf{F}$  that are linearly independent. A set of vectors is *linearly independent* if none of the vectors can be written as a linear combination of finitely many other vectors in the set.

**Example 11.21:** Consider the matrix

$$\begin{array}{ccc} " & 1 & 2 & 3 & " \\ & 5 & 7 & 9 & \\ & 4 & 5 & 6 & \\ _ & 2 & 1 & 0 & _ \end{array}$$

Notice that the second row is the sum of the first and third rows, while the fourth row is the third row minus twice the first row. However, the first and third rows are linearly independent; neither is a multiple of the other. Thus, the rank of the matrix is 2.

We could also draw this conclusion by examining the columns. The third column is twice the second column minus the first column. On the other hand, any two columns are linearly independent. Again, we conclude that the rank is 2. •

**Example 11.22:** Let us look at the array accesses in Fig. 11.18. The first access,  $X[i - 1]$ , has dimension 1, because the rank of the matrix  $[1 \ 0]$  is 1. That is, the one row is linearly independent, as is the first column.

The second access,  $X[i]$ , has dimension 2. The reason is that the matrix

$$\begin{array}{cc} " & 1 & 0 & " \\ & 0 & 1 & \end{array}$$

has two independent rows (and therefore two independent columns, of course). The third access,  $Y[j, j + 1]$ , is of dimension 1, because the matrix

$$\begin{array}{cc} " & 0 & 1 & " \\ & 0 & 1 & \end{array}$$

has rank 1. Note that the two rows are identical, so only one is linearly independent. Equivalently, the first column is 0 times the second column, so the columns are not independent. Intuitively, in a large, square array  $Y$ , the only elements accessed lie along a one-dimensional line, just above the main diagonal.

The fourth access,  $Y[l, 2]$  has dimension 0, because a matrix of all 0's has rank 0. Note that for such a matrix, we cannot find a linear sum of even one row that is nonzero. Finally, the last access,  $Z[i, i, 2 * i + j]$ , has dimension 2. Note that in the matrix for this access

$$\begin{array}{ccc} " & 0 & 0 & " \\ & 1 & 0 & \\ & 2 & 1 & \end{array}$$

the last two rows are linearly independent; neither is a multiple of the other. However, the first row is a linear "sum" of the other two rows, with both coefficients 0. •

### Null Space of a Matrix

A reference in a  $d$ -deep loop nest with rank  $r$  accesses  $O(n)$  data elements in  $O(n^d)$  iterations, so on average,  $O(n^{d-r})$  iterations must refer to the same array element. Which iterations access the same data? Suppose an access in this loop nest is represented by matrix-vector combination  $\mathbf{F}$  and  $\mathbf{f}$ . Let  $\mathbf{i}$  and  $\mathbf{i}'$  be two iterations that refer to the same array element. Then  $\mathbf{F}\mathbf{i} + \mathbf{f} = \mathbf{F}\mathbf{i}' + \mathbf{f}$ . Rearranging terms, we get

$$\mathbf{F}(\mathbf{i} - \mathbf{i}') = \mathbf{0}.$$

There is a well-known concept from linear algebra that characterizes when  $\mathbf{i}$  and  $\mathbf{i}'$  satisfy the above equation. The set of all solutions to the equation  $\mathbf{F}\mathbf{v} = \mathbf{0}$  is called the *null space* of  $\mathbf{F}$ . Thus, two iterations refer to the same array element if the difference of their loop-index vectors belongs to the null space of matrix  $\mathbf{F}$ .

It is easy to see that the null vector,  $\mathbf{v} = \mathbf{0}$ , always satisfies  $\mathbf{F}\mathbf{v} = \mathbf{0}$ . That is, two iterations surely refer to the same array element if their difference is  $\mathbf{0}$ ; in other words, if they are really the same iteration. Also, the null space is truly a vector space. That is, if  $\mathbf{F}\mathbf{v}_1 = \mathbf{0}$  and  $\mathbf{F}\mathbf{v}_2 = \mathbf{0}$ , then  $\mathbf{F}(\mathbf{v}_1 + \mathbf{v}_2) = \mathbf{0}$  and  $\mathbf{F}(c\mathbf{v}_1) = \mathbf{0}$ .

If the matrix  $\mathbf{F}$  is *fully ranked*, that is, its rank is  $d$ , then the null space of  $\mathbf{F}$  consists of only the null vector. In that case, iterations in a loop nest all refer to different data. In general, the dimension of the null space, also known as the *nullity*, is  $d - r$ . If  $d > r$ , then for each element there is a  $(d - r)$ -dimensional space of iterations that access that element.

The null space can be represented by its basis vectors. A  $k$ -dimensional null space is represented by  $k$  independent vectors; any vector that can be expressed as a linear combination of the basis vectors belongs to the null space.

**Example 11.23**: Let us reconsider the matrix of Example 11.21:

$$\begin{array}{ccc} 1 & 2 & 3 \\ 5 & 7 & 9 \\ 4 & 5 & 6 \\ 2 & 1 & 0 \end{array}$$

We determined in that example that the rank of the matrix is 2; thus the nullity is  $3 - 2 = 1$ . To find a basis for the null space, which in this case must be a single nonzero vector of length 3, we may suppose a vector in the null space to

be  $[x,y,z]$  and try to solve the equation

$$\begin{array}{ccc|c|c} 1 & 2 & 3 & x & 0 \\ 5 & 7 & 9 & y & 0 \\ 4 & 5 & 6 & z & 0 \\ 2 & 1 & 0 & & \end{array}$$

If we multiply the first two rows by the vector of unknowns, we get the two equations

$$\begin{array}{rcl} x + 2y + 3z & = & 0 \\ 5x + 7y + 9z & = & 0 \end{array}$$

We could write the equations that come from the third and fourth rows as well, but because there are no three linearly independent rows, we know that the additional equations add no new constraints on  $x$ ,  $y$ , and  $z$ . For instance, the equation we get from the third row,  $Ax + 5y + 6z = 0$  can be obtained by subtracting the first equation from the second.

We must eliminate as many variables as we can from the above equations. Start by using the first equation to solve for  $x$ ; that is,  $x = -2y - 3z$ . Then substitute for  $x$  in the second equation, to get  $-3y = 6z$ , or  $y = -2z$ . Since  $x = -2y - 3z$ , and  $y = -2z$ , it follows that  $x = z$ . Thus, the vector  $[x,y,z]$  is really  $[z, -2z,z]$ . We may pick any nonzero value of  $z$  to form the one and only basis vector for the null space. For example, we may choose  $z = 1$  and use  $[1, -2, 1]$  as the basis of the null space. •

**Example 11.24:** The rank, nullity, and null space for each of the references in Example 11.17 are shown in Fig. 11.19. Observe that the sum of the rank and nullity in all the cases is the depth of the loop nest, 2. Since the accesses and  $Z[l, i, 2 * i + j]$  have a rank of 2, all iterations refer to different locations.

Accesses  $X[i - 1]$  and  $Y[j, j + 1]$  both have rank-1 matrices, so  $O(n)$  iterations refer to the same location. In the former case, entire rows in the iteration space refer to the same location. In other words, iterations that differ only in the  $j$  dimension share the same location, which is succinctly represented by the basis of the null space,  $[0, 1]$ . For  $Y[j, j + 1]$ , entire columns in the iteration space refer to the same location, and this fact is succinctly represented by the basis of the null space,  $[1, 0]$ .

Finally, the access  $F[1, 2]$  refers to the same location in all the iterations. The null space corresponding has 2 basis vectors,  $[0, 1]$ ,  $[1, 0]$ , meaning that all pairs of iterations in the loop nest refer to exactly the same location. •

### 11.5.3 Self-Spatial Reuse

The analysis of spatial reuse depends on the data layout of the matrix. C matrices are laid out in row-major order and Fortran matrices are laid out in column-major order. In other words, array elements  $X[i,j]$  and  $X[i, j + 1]$  are



ACCESS	AFFINE EXPRESSION			RANK	NULL- ITY	BASIS OF NULL SPACE		
$\mathbf{x}C_{i-i}$	[ 1 0 ]	$\begin{matrix} i \\ \cdot j \cdot \end{matrix}$	+ [ - i ]	1	1		" 0 1	
$\mathbf{y}t_{i,j}$	" 1 0 " 0 1	$\begin{matrix} i \\ \cdot j \cdot \end{matrix}$	+ " 0 " 0	2	0			
$\mathbf{y}[j, j+1]$	" 0 1 " 0 1	$\begin{matrix} i \\ \cdot j \cdot \end{matrix}$	+ " 0 " 1	1	1		1 0	
$\mathbf{y}[1,2]$	" 0 0 " 0 0	$\begin{matrix} i \\ \cdot j \cdot \end{matrix}$	+ " 1 " 2	0	2	" 1 0		0 " 1
$\mathbf{z}[1, i, 2*i+j]$	" 0 0 " 1 0 2 1	$\begin{matrix} i \\ \cdot j \cdot \end{matrix}$	+ " 1 " 0 0	2	0			

Figure 11.19: Rank and nullity of affine accesses

contiguous in C and  $X[i, j]$  and  $X[i + 1, j]$  are contiguous in Fortran. Without loss of generality, in the rest of the chapter, we shall adopt the C (row-major) array layout.

As a first approximation, we consider two array elements to share the same cache line if and only if they share the same row in a two-dimensional array. More generally, in an array of  $d$  dimensions, we take array elements to share a cache line if they differ only in the last dimension. Since for a typical array and cache, many array elements can fit in one cache line, there is significant speedup to be had by accessing an entire row in order, even though, strictly speaking, we occasionally have to wait to load a new cache line.

The trick to discovering and taking advantage of self-spatial reuse is to drop the last row from the coefficient matrix  $\mathbf{F}$ . If the resulting *truncated* matrix has rank that is less than the depth of the loop nest, then we can assure spatial locality by making sure that the innermost loop varies only the last coordinate of the array.

Example 11.25: Consider the last access,  $Z[l, i, 2*i + j]$ , in Fig. 11.19. If we

delete the last row, we are left with the truncated matrix

$$\begin{array}{c} " 0 0 " \\ 1 \ 0 \end{array}$$

The rank of this matrix is evidently 1, and since the loop nest has depth 2, there is the opportunity for spatial reuse. In this case, since  $j$  is the inner-loop index, the inner loop visits contiguous elements of the array  $Z$  stored in row-major order. Making  $i$  the inner-loop index will not yield spatial locality, since as  $i$  changes, both the second and third dimensions change. •

The general rule for determining whether there is self-spatial reuse is as follows. As always, we assume that the loop indexes correspond to columns of the coefficient matrix in order, with the outermost loop first, and the innermost loop last. Then in order for there to be spatial reuse, the vector  $[0,0,\dots,0,1]$  must be in the null space of the truncated matrix. The reason is that if this vector is in the null space, then when we fix all loop indexes but the innermost one, we know that all dynamic accesses during one run through the inner loop vary in only the last array index. If the array is stored in row-major order, then these elements are all near one another, perhaps in the same cache line.

Example 11.26: Note that  $[0,1]$  (transposed as a column vector) is in the null space of the truncated matrix of Example 11.25. Thus, as mentioned there, we expect that with  $j$  as the inner-loop index, there will be spatial locality. On the other hand, if we reverse the order of the loops, so  $i$  is the inner loop, then the coefficient matrix becomes

$$\begin{array}{c} " 0 0 " \\ 0 \ 1 \end{array}$$

Now,  $[0,1]$  is not in the null space of this matrix. Rather, the null space is generated by the basis vector  $[1,0]$ . Thus, as we suggested in Example 11.25, we do not expect spatial locality if  $i$  is the inner loop.

We should observe, however, that the test for  $[0,0,\dots,0,1]$  being in the null space is not quite sufficient to assure spatial locality. For instance, suppose the access were not  $Z[l,i,2*i + j]$  but  $Z[l,i,2*i + 50*j]$ . Then, only every fiftieth element of  $Z$  would be accessed during one run of the inner loop, and we would not reuse a cache line unless it were long enough to hold more than 50 elements. •

### 11.5.4 Group Reuse

We compute group reuse only among accesses in a loop sharing the same coefficient matrix. Given two dynamic accesses  $F_{i_1} + f_1$  and  $F_{i_2} + f_2$ , reuse of the same data requires that

$$F_{i_1} + \mathbf{f}_1 = F_{i_2} + \mathbf{f}_2$$

or

$$\mathbf{F}(\mathbf{i} - \mathbf{i}_2) = (\mathbf{f}_2 - \mathbf{f}_1).$$

Suppose  $\mathbf{v}$  is one solution to this equation. Then if  $\mathbf{w}$  is any vector in the null space of  $\mathbf{F}$ ,  $\mathbf{w} + \mathbf{v}$  is also a solution, and in fact those are all the solutions to the equation.

Example 11.27: The following 2-deep loop nest

```
for (i = 1; i <= n; i++)
    for (j = 1; j <= n;
        Z[i,j] = Z[i-1,j];
```

has two array accesses,  $Z[i,j]$  and  $Z[i-1,j]$ . Observe that these two accesses are both characterized by the coefficient matrix

$$\begin{bmatrix} 1 & 0 \\ 0 & 1 \end{bmatrix}$$

like the second access,  $Y[i,j]$  in Fig. 11.19. This matrix has rank 2, so there is no self-temporal reuse.

However, each access exhibits self-spatial reuse. As described in Section 11.5.3, when we delete the bottom row of the matrix, we are left with only the top row,  $[1,0]$ , which has rank 1. Since  $[0,1]$  is in the null space of this truncated matrix, we expect spatial reuse. As each incrementation of inner-loop index  $j$  increases the second array index by one, we in fact do access adjacent array elements, and will make maximum use of each cache line.

Although there is no self-temporal reuse for either access, observe that the two references  $Z[i,j]$  and  $Z[i-1,j]$  access almost the same set of array elements. That is, there is group-temporal reuse because the data read by access  $Z[i-1,j]$  is the same as the data written by access  $Z[i,j]$ , except for the case  $i = 1$ . This simple pattern applies to the entire iteration space and can be exploited to improve data locality in the code. Formally, discounting the loop bounds, the two accesses  $Z[i,j]$  and  $Z[i-1,j]$  refer to the same location in iterations  $(k,ji)$  and  $(j_2, j_2)$ , respectively, provided

$$\begin{bmatrix} 1 & 0 \\ 0 & 1 \end{bmatrix} h + \begin{bmatrix} 1 & 0 \\ 0 & 1 \end{bmatrix} h +$$

Rewriting the terms, we get

$$\begin{bmatrix} 1 & 0 \\ 0 & 1 \end{bmatrix} \begin{bmatrix} k - k \\ h - 32 \end{bmatrix} \begin{bmatrix} -1 \\ 0 \end{bmatrix}$$

That is,  $ji = J2$  and  $i_2 = k + 1$ .

Notice that the reuse occurs along the  $i$ -axis of the iteration space. That is, the iteration  $(kih)$  occurs  $n$  iterations (of the inner loop) after the iteration

Thus, many iterations are executed before the data written is reused. This data may or may not still be in the cache. If the cache manages to hold two consecutive rows of matrix  $Z$ , then access  $Z[i - \dots]$  does not miss in the cache, and the total number of cache misses for the entire loop nest is  $n^2/c$ , where  $c$  is the number of elements per cache line. Otherwise, there will be twice as many misses, since both static accesses require a new cache line for each  $c$  dynamic accesses. •

Example 11.28 : Suppose there are two accesses

$$A[i, j, i + j] \text{ and } A[i + 1, j - 1, \% + j]$$

in a 3-deep loop nest, with indexes  $i, j,$  and  $k,$  from the outer to the inner loop. Then two accesses  $i_1 = [i, j, k]$  and  $i_2 = [i + 1, j - 1, \% + j]$  reuse the same element whenever

$$\begin{bmatrix} k \\ h \\ h \end{bmatrix} + \begin{bmatrix} 0 \\ 0 \\ 0 \end{bmatrix} = \begin{bmatrix} 1 & 0 & 0 \\ 0 & 1 & 0 \\ 1 & 1 & 0 \end{bmatrix} \begin{bmatrix} i \\ j \\ \% + j \end{bmatrix} + \begin{bmatrix} 1 \\ -1 \\ 0 \end{bmatrix}$$

One solution to this equation for a vector  $v = [i - i_1, j_1 - j_2, \&i - \&_2]$  is  $v = [1, -1, 0]$ ; that is,  $i_1 = i_2 + 1, j_1 = j_2 - 1,$  and  $k_1 = k_2$ .<sup>4</sup> However, the null space of the matrix

$$\mathbf{F} = \begin{bmatrix} 1 & 0 & 0 \\ 0 & 1 & 0 \\ 1 & 1 & 0 \end{bmatrix}$$

is generated by the basis vector  $[0, 0, 1]$ ; that is, the third loop index,  $k,$  can be arbitrary. Thus,  $v,$  the solution to the above equation, is any vector  $[1, -1, m]$  for some  $m.$  Put another way, a dynamic access to  $A[i, j, i + j],$  in a loop nest with indexes  $i, j,$  and  $k,$  is reused not only by other dynamic accesses  $A[i, j, i + j]$  with the same values of  $i$  and  $j$  and a different value of  $k,$  but also by dynamic accesses  $A[i + 1, j - 1, i + j]$  with loop index values  $i + 1, j - 1,$  and any value of  $k.$  •

Although we shall not do so here, we can reason about group-spatial reuse analogously. As per the discussion of self-spatial reuse, we simply drop the last dimension from consideration.

The extent of reuse is different for the different categories of reuse. Self-temporal reuse gives the most benefit: a reference with a  $d$ -dimensional null space reuses the same data  $O(n^d)$  times. The extent of self-spatial reuse is limited by the length of the cache line. Finally, the extent of group reuse is limited by the number of references in a group sharing the reuse.

<sup>4</sup>It is interesting to observe that, although there is a solution in this case, there would be no solution if we changed one of the third components from  $i + j$  to  $i + j + 1.$  That is, in the example as given, both accesses touch those array elements that lie in the 2-dimensional subspace  $S$  defined by "the third component is the sum of the first two components." If we changed  $i + j$  to  $i + j + 1,$  none of the elements touched by the second access would lie in  $S,$  and there would be no reuse at all.

### 11.5.5 Exercises for Section 11.5

**Exercise 11.5.1:** Compute the ranks of each of the matrices in Fig. 11.20. Give both a maximal set of linearly dependent columns and a maximal set of linearly dependent rows.

0 1	1 2 3 4	0 0 1
1 2	5 6 7 8	0 1 1
2 3	9 10 12 15	1 1 1
3 4	3 2 2 3	5 6 3
(a)	(b)	(c)

Figure 11.20: Compute the ranks and null spaces of these matrices

**Exercise 11.5.2:** Find a basis for the null space of each matrix in Fig. 11.20.

**Exercise 11.5.3:** Assume that the iteration space has dimensions (variables)  $i$ ,  $j$ , and  $k$ . For each of the accesses below, describe the subspaces that refer to the following single elements of the array:

- a)  $A[i, i + j]$
- b)  $A[i, i + l, i + 2]$
- ! c)  $A[i, i, j + k]$
- ! d)  $A[i-j, j-k, k-i]$

! **Exercise 11.5.4:** Suppose array  $A$  is stored in row-major order and accessed inside the following loop nest:

```

for (i = 0; i < 100; i++)
  for (j = 0; j < 100; j++)
    for (k = 0; k < 100; k++)
      <some access to A>

```

Indicate for each of the following accesses whether it is possible to rewrite the loops so that the access to  $A$  exhibits self-spatial reuse; that is, entire cache lines are used consecutively. Show how to rewrite the loops, if so. Note: the rewriting of the loops may involve both reordering and introduction of new loop indexes. However, you may not change the layout of the array, e.g., by changing it to column-major order. Also note: in general, reordering of loop indexes may be legal or illegal, depending on criteria we develop in the next section. However, in this case, where the effect of each access is simply to set an array element to 0, you do not have to worry about the effect of reordering loops as far as the semantics of the program is concerned.

a)  $A[i+1, i+k, j] = 0$ .

!! b)  $A[tj+k, i, i] = 0$ .

c)  $A[i, j, k, i+j+k] = 0$ .

!! d)  $A[i, j-k, i+j, i+k] = 0$ .

**Exercise 11.5.5:** In Section 11.5.3 we commented that we get spatial locality if the innermost loop varies only as the last coordinate of an array access. However, that assertion depended on our assumption that the array was stored in row-major order. What condition would assure spatial locality if the array were stored in column-major order?

! **Exercise 11.5.6:** In Example 11.28 we observed that the the existence of reuse between two similar accesses depended heavily on the particular expressions for the coordinates of the array. Generalize our observation there to determine for which functions  $f(i, j)$  there is reuse between the accesses  $A[i, j, i + j]$  and  $A[i + l, j - l, f(i, j)]$ .

! **Exercise 11.5.7:** In Example 11.27 we suggested that there will be more cache misses than necessary if rows of the matrix  $Z$  are so long that they do not fit in the cache. If that is the case, how could you rewrite the loop nest in order to guarantee group-spatial reuse?

## 11.6 Array Data-Dependence Analysis

Parallelization or locality optimizations frequently reorder the operations executed in the original program. As with all optimizations, operations can be reordered only if the reordering does not change the program's output. Since we cannot, in general, understand deeply what a program does, code optimization generally adopts a simpler, conservative test for when we can be sure that the program output is not affected: we check that the operations on any memory location are done in the same order in the original and modified programs. In the present study, we focus on array accesses, so the array elements are the memory locations of concern.

Two accesses, whether read or write, are clearly *independent* (can be reordered) if they refer to two different locations. In addition, read operations do not change the memory state and therefore are also independent. Following Section 11.5, we say that two accesses are *data dependent* if they refer to the same memory location and at least one of them is a write operation. To be sure that the modified program does the same as the original, the relative execution ordering between every pair of data-dependent operations in the original program must be preserved in the new program.

Recall from Section 10.2.1 that there are three flavors of data dependence:

1. *True dependence*, where a write is followed by a read of the same location.

2. *Antidependence*, where a read is followed by a write to the same location.
3. *Output dependence*, which is two writes to the same location.

In the discussion above, data dependence is defined for dynamic accesses. We say that a static access in a program depends on another as long as there exists a dynamic instance of the first access that depends on some instance of the second.<sup>5</sup>

It is easy to see how data dependence can be used in parallelization. For example, if no data dependences are found in the accesses of a loop, we can easily assign each iteration to a different processor. Section 11.7 discusses how we use this information systematically in parallelization.

### 11.6.1 Definition of Data Dependence of Array Accesses

Let us consider two static accesses to the same array in possibly different loops. The first is represented by access function and bounds  $T = (\mathbf{F}, \mathbf{f}, \mathbf{B}, \mathbf{b})$  and is in a  $d$ -deep loop nest; the second is represented by  $T' = (\mathbf{F}', \mathbf{f}', \mathbf{B}', \mathbf{b}')$  and is in a  $d'$ -deep loop nest. These accesses are data dependent if

1. At least one of them is a write reference and
2. There exist vectors  $\mathbf{i}$  in  $Z'$  and  $\mathbf{i}'$  in  $Z'$  such that
  - (a)  $\mathbf{B}\mathbf{i} > \mathbf{0}$ ,
  - (b)  $\mathbf{B}'\mathbf{i}' > \mathbf{0}$ , and
  - (c)  $\mathbf{F}\mathbf{i} + \mathbf{f} = \mathbf{F}'\mathbf{i}' + \mathbf{f}'$ .

Since a static access normally embodies many dynamic accesses, it is also meaningful to ask if its dynamic accesses may refer to the same memory location. To search for dependencies between instances of the same static access, we assume  $T = T'$  and augment the definition above with the additional constraint that  $\mathbf{i} \wedge \mathbf{i}'$  to rule out the trivial solution.

Example 11.29: Consider the following 1-deep loop nest:

```
for (i = 1; i < 10; i++) {
    z[i] = z[i-1];
}
```

This loop has two accesses:  $Z[i - 1]$  and  $Z[i]$ ; the first is a read reference and the second a write. To find all the data dependences in this program, we need to check if the write reference shares a dependence with itself and with the read reference:

<sup>5</sup>Recall the difference between static and dynamic accesses. A static access is an array reference at a particular location in a program, while a dynamic access is one execution of that reference.

1. *Data dependence between  $Z[i - 1]$  and  $Z[i]$ .* Except for the first iteration, each iteration reads the value written in the previous iteration. Mathematically, we know that there is a dependence because there exist integers  $i$  and  $i'$  such that

$$1 < i < 10, 1 < i' < 10, \text{ and } i - 1 = i'.$$

There are nine solutions to the above system of constraints: ( $i = 2, i' = 1$ ), ( $i = 3, i' = 2$ ), and so forth.

2. *Data dependence between  $Z[i]$  and itself.* It is easy to see that different iterations in the loop write to different locations; that is, there are no data dependencies among the instances of the write reference  $Z[i]$ . Mathematically, we know that there does not exist a dependence because there do not exist integers  $i$  and  $i'$  satisfying

$$1 < i < 10, 1 < i' < 10, i = i', \text{ and } i \neq i'.$$

Notice that the third condition,  $i = i'$ , comes from the requirement that  $Z[i]$  and  $Z[i']$  are the same memory location. The contradictory fourth condition,  $i \neq i'$ , comes from the requirement that the dependence be nontrivial — between different dynamic accesses.

It is not necessary to consider data dependences between the read reference  $Z[i - 1]$  and itself because any two read accesses are independent. •

## 11.6.2 Integer Linear Programming

Data dependence requires finding whether there exist integers that satisfy a system consisting of equalities and inequalities. The equalities are derived from the matrices and vectors representing the accesses; the inequalities are derived from the loop bounds. Equalities can be expressed as inequalities: an equality  $x = y$  can be replaced by two inequalities,  $x > y$  and  $y > x$ .

Thus, data dependence may be phrased as a search for integer solutions that satisfy a set of linear inequalities, which is precisely the well-known problem of *integer linear programming*. Integer linear programming is an NP-complete problem. While no polynomial algorithm is known, heuristics have been developed to solve linear programs involving many variables, and they can be quite fast in many cases. Unfortunately, such standard heuristics are inappropriate for data dependence analysis, where the challenge is to solve many small and simple integer linear programs rather than large complicated integer linear programs.

The data dependence analysis algorithm consists of three parts:



1. Apply the GCD (Greatest Common Divisor) test, which checks if there is an integer solution to the equalities, using the theory of linear Diophantine equations. If there are no integer solutions, then there are no data dependences. Otherwise, we use the equalities to substitute for some of the variables thereby obtaining simpler inequalities.
2. Use a set of simple heuristics to handle the large numbers of typical inequalities.
3. In the rare case where the heuristics do not work, we use a linear integer programming solver that uses a branch-and-bound approach based on Fourier-Motzkin elimination.

### 11.6.3 The GCD Test

The first subproblem is to check for the existence of integer solutions to the equalities. Equations with the stipulation that solutions must be integers are known as *Diophantine equations*. The following example shows how the issue of integer solutions arises; it also demonstrates that even though many of our examples involve a single loop nest at a time, the data dependence formulation applies to accesses in possibly different loops.

Example 11.30: Consider the following code fragment:

```

for (i = 1; i < 10; i++) {
    Z[2*i] = ...;
}
for (j = 1; j < 10;      {
    Z[2*j+1] = ...;
}

```

The access  $Z[2*i]$  only touches even elements of  $Z$ , while access  $Z[2*j+1]$  touches only odd elements. Clearly, these two accesses share no data dependence regardless of the loop bounds. We can execute iterations in the second loop before the first, or interleave the iterations. This example is not as contrived as it may look. An example where even and odd numbers are treated differently is an array of complex numbers, where the real and imaginary components are laid out side by side.

To prove the absence of data dependences in this example, we reason as follows. Suppose there were integers  $i$  and  $j$  such that  $Z[2*i]$  and  $Z[2*j+1]$  are the same array element. We get the Diophantine equation

$$2i = 2j + 1.$$

There are no integers  $i$  and  $j$  that can satisfy the above equation. The proof is that if  $i$  is an integer, then  $2i$  is even. If  $j$  is an integer, then  $2j$  is even, so  $2j + 1$  is odd. No even number is also an odd number. Therefore, the equation

has no integer solutions, and thus there is no dependence between the read and write accesses. •

To describe when there is a solution to a linear Diophantine equation, we need the concept of the *greatest common divisor* (GCD) of two or more integers. The GCD of integers  $a_1, a_2, \dots, a_n$ , denoted  $\gcd(a_1, a_2, \dots, a_n)$ , is the largest integer that evenly divides all these integers. GCD's can be computed efficiently by the well-known Euclidean algorithm (see the box on the subject).

**Example 11.31:**  $\gcd(24, 36, 54) = 6$ , because  $24/6$ ,  $36/6$ , and  $54/6$  each have remainder 0, yet any integer larger than 6 must leave a nonzero remainder when dividing at least one of 24, 36, and 54. For instance, 12 divides 24 and 36 evenly, but not 54. •

The importance of the GCD is in the following theorem.

**Theorem 11.32:** The linear Diophantine equation

$$a_1x_1 + a_2x_2 + \dots + a_nx_n = c$$

has an integer solution for  $x_1, x_2, \dots, x_n$  if and only if  $\gcd(a_1, a_2, \dots, a_n)$  divides  $c$ . •

**Example 11.33:** We observed in Example 11.30 that the linear Diophantine equation  $2i = 2j + 1$  has no solution. We can write this equation as

$$2i - 2j = 1.$$

Now  $\gcd(2, -2) = 2$ , and 2 does not divide 1 evenly. Thus, there is no solution. For another example, consider the equation

$$24x + 36y + 54z = 30.$$

Since  $\gcd(24, 36, 54) = 6$ , and  $30/6 = 5$ , there is a solution in integers for  $x$ ,  $y$ , and  $z$ . One solution is  $x = -1$ ,  $y = 0$ , and  $z = 1$ , but there are an infinity of other solutions. •

The first step to the data dependence problem is to use a standard method such as Gaussian elimination to solve the given equalities. Every time a linear equation is constructed, apply Theorem 11.32 to rule out, if possible, the existence of an integer solution. If we can rule out such solutions, then answer "no". Otherwise, we use the solution of the equations to reduce the number of variables in the inequalities.

**Example 11.34:** Consider the two equalities

$$\begin{aligned} x - 2y + z &= 0 \\ 3x + 2y + z &= 5 \end{aligned}$$

## The Euclidean Algorithm

The *Euclidean algorithm* for finding  $\text{gcd}(a, b)$  works as follows. First, assume that  $a$  and  $b$  are positive integers, and  $a > b$ . Note that the GCD of negative numbers, or the GCD of a negative and a positive number is the same as the GCD of their absolute values, so we can assume all integers are positive.

If  $a = b$ , then  $\text{gcd}(a, b) = a$ . If  $a > b$ , let  $c$  be the remainder of  $a/b$ . If  $c = 0$ , then  $b$  evenly divides  $a$ , so  $\text{gcd}(a, b) = b$ . Otherwise, compute  $\text{gcd}(b, c)$ ; this result will also be  $\text{gcd}(a, b)$ .

To compute  $\text{gcd}(a_1, a_2, \dots, a_n)$ , for  $n > 2$ , use the Euclidean algorithm to compute  $\text{gcd}(a_1, a_2) = c$ . Then recursively compute  $\text{gcd}(c, a_3, a_4, \dots, a_n)$ .

Looking at each equality by itself, it appears there might be a solution. For the first equality,  $\text{gcd}(1, -2, 1) = 1$  divides 0, and for the second equality,  $\text{gcd}(3, 2, 1) = 1$  divides 5. However, if we use the first equality to solve for  $z = 2y - x$  and substitute for  $z$  in the second equality, we get  $2x + 4y = 5$ . This Diophantine equation has no solution, since  $\text{gcd}(2, 4) = 2$  does not divide 5 evenly. •

### 11.6.4 Heuristics for Solving Integer Linear Programs

The data dependence problem requires many simple integer linear programs be solved. We now discuss several techniques to handle simple inequalities and a technique to take advantage of the similarity found in data dependence analysis.

#### Independent-Variables Test

Many of the integer linear programs from data dependence consist of inequalities that involve only one unknown. The programs can be solved simply by testing if there are integers between the constant upper bounds and constant lower bounds independently.

Example 11.35 : Consider the nested loop

```
for (i = 0; i <= 10; i++)
  for (j = 0; j <= 10; j++)
    z[i, j] = z[j+10, i+9];
```

To find if there is a data dependence between  $Z[i, j]$  and  $Z[j+10, i+9]$ , we ask if there exist integers  $i, j, i'$ , and  $j'$  such that

$$\begin{aligned} 0 < i, j, i', j' < 10 \\ i &= j' + 10 \\ j &= i' + 11 \end{aligned}$$

The GCD test, applied to the two equalities above, will determine that there may be an integer solution. The integer solutions to the equalities are expressed by

$$i = t_1, j = t_2, i' = t_2 - 11, j' = t_1 - 10.$$

for any integers  $t_1$  and  $t_2$ . Substituting the variables  $t_1$  and  $t_2$  into the linear inequalities, we get

$$\begin{aligned} 0 < t_1 < 10 \\ 0 < t_2 < 10 \\ 0 < t_2 - 11 < 10 \\ 0 < t_1 - 10 < 10 \end{aligned}$$

Thus, combining the lower bounds from the last two inequalities with the upper bounds from the first two, we deduce

$$\begin{aligned} 10 < t_1 < 10 \\ 11 < t_2 < 10 \end{aligned}$$

Since the lower bound on  $t_2$  is greater than its upper bound, there is no integer solution, and hence no data dependence. This example shows that even if there are equalities involving several variables, the GCD test may still create linear inequalities that involve one variable at a time. •

### Acyclic Test

Another simple heuristic is to find if there exists a variable that is bounded below or above by a constant. In certain circumstances, we can safely replace the variable by the constant; the simplified inequalities have a solution if and only if the original inequalities have a solution. Specifically, suppose every lower bound on  $v_i$  is of the form

$$C_0 < C_1 v_i \text{ for some } C_1 > 0.$$

while the upper bounds on  $v_i$  are all of the form

$$C_1 v_i < C_0 + C_2 v_i + \dots + C_n v_n + \dots + c_n + v_n$$

where  $c_1, c_2, \dots, c_n$  are all nonnegative. Then we can replace variable  $v_i$  by its smallest possible integer value. If there is no such lower bound, we simply

replace  $v_i$  with  $-\infty$ . Similarly, if every constraint involving  $V_j$  can be expressed in the two forms above, but with the directions of the inequalities reversed, then we can replace variable  $V_j$  with the largest possible integer value, or by  $\infty$  if there is no constant upper bound. This step can be repeated to simplify the inequalities and in some cases determine if there is a solution.

Example 11.36: Consider the following inequalities:

$$\begin{array}{rcl} 1 & < & V_i, V_2 < 10 \\ 0 & < & V_3 < 4 \\ V_2 & < & V_i \\ & & V_i < v_3 + 4 \end{array}$$

Variable  $v_i$  is bounded from below by  $v_2$  and from above by  $v_3$ . However,  $v_2$  is bounded from below only by the constant 1, and  $v_3$  is bounded from above only by the constant 4. Thus, replacing  $v_2$  by 1 and  $v_3$  by 4 in the inequalities, we obtain

$$\begin{array}{rcl} 1 & < & v_i < 10 \\ 1 & < & v_i \\ & & v_i < 8 \end{array}$$

which can now be solved easily with the independent-variables test. •

### The Loop-Residue Test

Let us now consider the case where every variable is bounded from below and above by other variables. It is commonly the case in data dependence analysis that constraints have the form  $V_j < V_i + c$ , which can be solved using a simplified version of the *loop-residue test* due to Shostack. A set of these constraints can be represented by a directed graph whose nodes are labeled with variables. There is an edge from  $V_i$  to  $V_j$  labeled  $c$  whenever there is a constraint  $V_j < V_i + c$ .

We define the *weight* of a path to be the sum of the labels of all the edges along the path. Each path in the graph represents a combination of the constraints in the system. That is, we can infer that  $v < v' + c$  whenever there exists a path from  $v$  to  $v'$  with weight  $c$ . A cycle in the graph with weight  $c$  represents the constraint  $v < v + c$  for each node  $v$  on the cycle. If we can find a negatively weighted cycle in the graph, then we can infer  $v < v$ , which is impossible. In this case, we can conclude that there is no solution and thus no dependence.

We can also incorporate into the loop-residue test constraints of the form  $c < v$  and  $v < c$  for variable  $v$  and constant  $c$ . We introduce into the system of inequalities a new dummy variable  $v_0$ , which is added to each constant upper and lower bound. Of course,  $v_0$  must have value 0, but since the loop-residue test only looks for cycles, the actual values of the variables never becomes significant. To handle constant bounds, we replace

$$\begin{aligned}
 v < c & \text{ by } v < v + c \\
 c < v & \text{ by } v < v - c.
 \end{aligned}$$

Example 11.37: Consider the inequalities

$$\begin{aligned}
 1 &< v_1, v_2 < 10 \\
 0 &< v_3 < 4 \\
 v_1 &< v_3 \\
 2v_1 &< 2v_3 - 7
 \end{aligned}$$

The constant upper and lower bounds on  $v_1$  become  $v_1 < 10$  and  $v_1 > 1$ ; the constant bounds on  $v_2$  and  $v_3$  are handled similarly. Then, converting the last constraint to  $v_1 < v_3 - 4$ , we can create the graph shown in Fig. 11.21. The cycle  $v_1, v_3, v_0, v_1$  has weight  $-1$ , so there is no solution to this set of inequalities. •

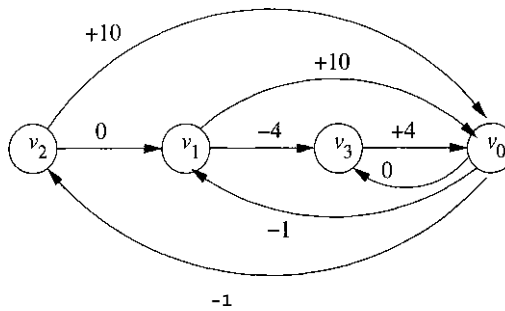

Figure 11.21: Graph for the constraints of Example 11.37

**Memoization**

Often, similar data dependence problems are solved repeatedly, because simple access patterns are repeated throughout the program. One important technique to speed up data dependence processing is to use *memoization*. Memoization tabulates the results to the problems as they are generated. The table of stored solutions is consulted as each problem is presented; the problem needs to be solved only if the result to the problem cannot be found in the table.

**11.6.5 Solving General Integer Linear Programs**

We now describe a general approach to solving the integer linear programming problem. The problem is NP-complete; our algorithm uses a branch-and-bound approach that can take an exponential amount of time in the worst case. However, it is rare that the heuristics of Section 11.6.4 cannot resolve the problem, and even if we do need to apply the algorithm of this section, it seldom needs to perform the branch-and-bound step.

The approach is to first check for the existence of rational solutions to the inequalities. This problem is the classical linear-programming problem. If there is no rational solution to the inequalities, then the regions of data touched by the accesses in question do not overlap, and there surely is no data dependence. If there is a rational solution, we first try to prove that there is an integer solution, which is commonly the case. Failing that, we then split the polyhedron bounded by the inequalities into two smaller problems and recurse.

Example 11.38: Consider the following simple loop:

```
for (i = 1; i < 10; i++)
    Z[i] = Z[i+10J];
```

The elements touched by access  $Z[i]$  are  $Z[1], \dots, Z[9]$ , while the elements touched by  $Z[i + 10]$  are  $Z[11], \dots, Z[19]$ . The ranges do not overlap and therefore there are no data dependences. More formally, we need to show that there are no two dynamic accesses  $i$  and  $i'$ , with  $1 < i < 9$ ,  $1 < i' < 9$ , and  $i = i' + 10$ . If there were such integers  $i$  and  $i'$ , then we could substitute  $i' + 10$  for  $i$  and get the four constraints on  $i'$ :  $1 < i' < 9$  and  $1 < i' + 10 < 9$ . However,  $i' + 10 < 9$  implies  $i' < -1$ , which contradicts  $1 < i'$ . Thus, no such integers  $i$  and  $i'$  exist. •

Algorithm 11.39 describes how to determine if an integer solution can be found for a set of linear inequalities based on the Fourier-Motzkin elimination algorithm.

Algorithm 11.39: Branch-and-bound solution to integer linear programming problems.

**INPUT:** A convex polyhedron  $S_n$  over variables  $v_1, \dots, v_n$ .

**OUTPUT:** "yes" if  $S_n$  has an integer solution, "no" otherwise.

**METHOD:** The algorithm is shown in Fig. 11.22. •

Lines (1) through (3) attempt to find a rational solution to the inequalities. If there no rational solution, there is no integer solution. If a rational solution is found, this means that the inequalities define a nonempty polyhedron. It is relatively rare for such a polyhedron not to include any integer solutions — for that to happen, the polyhedron must be relatively thin along some dimension and fit between integer points.

Thus, lines (4) through (9) try to check quickly if there is an integer solution. Each step of the Fourier-Motzkin elimination algorithm produces a polyhedron with one fewer dimension than the previous one. We consider the polyhedra in reverse order. We start with the polyhedron with one variable and assign to that variable an integer solution roughly in the middle of the range of possible values if possible. We then substitute the value for the variable in all other polyhedra, decreasing their unknown variables by one. We repeat the same process until

- 1) apply Algorithm 11.13 to  $S_n$  to project away variables  $v_n, v_{n-1}, \dots, v_1$  in that order;
- 2) let  $S_i$  be the polyhedron after projecting away  $v_n, i$ , for  $i = n - 1, n - 2, \dots, 0$ ;
- 3) **if**  $S_0$  is false **return** "no";  
/\* There is no rational solution if  $S_0$ , which involves only constants, has unsatisfiable constraints \*/
- 4) **for** ( $i = 1; i < n; i++$ ) {
- 5)     **if** ( $S_i$  does not include an integer value) **break**;
- 6)     pick  $C_i$ , an integer in the middle of the range for  $V_i$  in  $S_i$ ;
- 7)     modify  $S_i$  by replacing  $v_i$  by  $C_i$ ;
- 8) }
- 9) **if** ( $i == n + 1$ ) **return** "yes";
- 10) **if** ( $i == 1$ ) **return** "no";
- 11) let the lower and upper bounds on  $V_i$  in  $S_i$  be  $k$  and  $U_i$ , respectively;
- 12) recursively apply this algorithm to  $S_n \cup \{v^i < [k]\}$  and  $S_n \cup \{v^i > [U_i]\}$ ;
- 13) **if** (either returns "yes") **return** "yes" **else return** "no";

Figure 11.22: Finding an integer solution in inequalities

we have processed all the polyhedra, in which case an integer solution is found, or we have found a variable for which there is no integer solution.

If we cannot find an integer value for even the first variable, there is no integer solution (line 10). Otherwise, all we know is that there is no integer solution including the combination of specific integers we have picked so far, and the result is inconclusive. Lines (11) through (13) represent the branch-and-bound step. If variable  $V_i$  is found to have a rational but not integer solution, we split the polyhedron into two with the first requiring that  $V_i$  must be an integer smaller than the rational solution found, and the second requiring that  $V_i$  must be an integer greater than the rational solution found. If neither has a solution, then there is no dependence.

### 11.6.6 Summary

We have shown that essential pieces of information that a compiler can glean from array references are equivalent to certain standard mathematical concepts. Given an access function  $T = (\mathbf{F}, \mathbf{f}, \mathbf{B}, \mathbf{b})$ :

1. The dimension of the data region accessed is given by the rank of the matrix  $\mathbf{F}$ . The dimension of the space of accesses to the same location is given by the nullity of  $\mathbf{F}$ . Iterations whose differences belong to the null space of  $\mathbf{F}$  refer to the same array elements.



2. Iterations that share self-temporal reuse of an access are separated by vectors in the null space of  $\mathbf{F}$ . Self-spatial reuse can be computed similarly by asking when two iterations use the same row, rather than the same element. Two accesses  $\mathbf{F}\mathbf{i}_1 + \mathbf{f}_1$  and  $\mathbf{F}\mathbf{i}_2 + \mathbf{f}_2$  share easily exploitable locality along the  $\mathbf{d}$  direction, if  $\mathbf{d}$  is the particular solution to the equation  $\mathbf{F}\mathbf{d} = (\mathbf{f}_1 - \mathbf{f}_2)$ . In particular, if  $\mathbf{d}$  is the direction corresponding to the innermost loop, i.e., the vector  $[0, 0, \dots, 0, 1]$ , then there is spatial locality if the array is stored in row-major form.
3. The data dependence problem — whether two references can refer to the same location — is equivalent to integer linear programming. Two access functions share a data dependence if there are integer-valued vectors  $\mathbf{i}$  and  $\mathbf{i}'$  such that  $\mathbf{B}\mathbf{i} > \mathbf{0}$ ,  $\mathbf{B}'\mathbf{i}' > \mathbf{0}$ , and  $\mathbf{F}\mathbf{i} + \mathbf{f} = \mathbf{F}'\mathbf{i}' + \mathbf{f}$ .

### 11.6.7 Exercises for Section 11.6

**Exercise 11.6.1:** Find the GCD's of the following sets of integers:

- a)  $\{16, 24, 56\}$ .
- b)  $\{-45, 105, 240, \dots\}$ .
- ! c)  $\{84, 105, 180, 315, 350\}$ .

**Exercise 11.6.2:** For the following loop

```
for (i = 0; i < 10; i++)
    A[i] = A[10-i];
```

indicate all the

- a) True dependences (write followed by read of the same location).
- b) Antidependences (read followed by write to the same location).
- c) Output dependences (write followed by another write to the same location).

**! Exercise 11.6.3:** In the box on the Euclidean algorithm, we made a number of assertions without proof. Prove each of the following:

- a) The Euclidean algorithm as stated always works. In particular,  $\text{gcd}(6, c) = \text{gcd}(0, 6)$ , where  $c$  is the nonzero remainder of  $a/b$ .
- b)  $\text{gcd}(a, \&) = \text{gcd}(a, -b)$ .
- c)  $\text{gcd}(a_1, a_2, \dots, a_n) = \text{gcd}(\text{gcd}(a_1, a_2), a_3, a_4, \dots, a_n)$  for  $n > 2$ .

- d) The GCD is really a function on sets of integers; i.e., order doesn't matter. Show the *commutative law* for GCD:  $\text{gcd}(a, b) = \text{gcd}(b, a)$ . Then, show the more difficult statement, the *associative law* for GCD:  $\text{gcd}(\text{gcd}(a, b), c) = \text{gcd}(a, \text{gcd}(b, c))$ . Finally, show that together these laws imply that the GCD of a set of integers is the same, regardless of the order in which the GCD's of pairs of integers are computed.
- e) If  $S$  and  $T$  are sets of integers, then  $\text{gcd}(S \cup T) = \text{gcd}(\text{gcd}(S), \text{gcd}(T))$ .

**! Exercise 11.6.4:** Find another solution to the second Diophantine equation in Example 11.33.

**Exercise 11.6.5:** Apply the independent-variables test in the following situation. The loop nest is

```

for (i=0; i<100; i++)
  for (j=0; j<100; j++)
    for (k=0; k<100; k++)

```

and inside the nest is an assignment involving array accesses. Determine if there are any data dependences due to each of the following statements:

- a)  $A[i, j, k] = A[i+100, j+100, k+100]$ .
- b)  $A[i, j, k] = A[j+100, k+100, i+100]$ .
- c)  $A[i, j, k] = A[j-50, k-50, i-50]$ .
- d)  $A[i, j, k] = A[i+99, k+100, j]$ .

**Exercise 11.6.6:** In the two constraints

$$\begin{array}{l} 1 < x < y - 100 \\ 3 < x < 2y - 50 \end{array}$$

eliminate  $x$  by replacing it by a constant lower bound on  $y$ .

**Exercise 11.6.7:** Apply the loop-residue test to the following set of constraints:

$$\begin{array}{l} 0 < x < 99 \quad y < a; -50 \\ 0 < z < 99 \quad z < y - 60 \\ 0 < z < 99 \end{array}$$

**Exercise 11.6.8:** Apply the loop-residue test to the following set of constraints:

$$\begin{array}{l} 0 < z < 99 \quad y < x - 50 \\ 0 < y < 99 \quad z < y + 40 \\ 0 < x < 99 \quad x < z + 20 \end{array}$$

Exercise 11.6.9: Apply the loop-residue test to the following set of constraints:

$$\begin{array}{ll} 0 < x < 99 & y < x - 100 \\ 0 < y < 99 & z < y + 60 \\ 0 < z < 99 & x < z + 50 \end{array}$$

## 11.7 Finding Synchronization-Free Parallelism

Having developed the theory of affine array accesses, their reuse of data, and the dependences among them, we shall now begin to apply this theory to parallelization and optimization of real programs. As discussed in Section 11.1.4, it is important that we find parallelism while minimizing communication among processors. Let us start by studying the problem of parallelizing an application without allowing any communication or synchronization between processors at all. This constraint may appear to be a purely academic exercise; how often can we find programs and routines that have such a form of parallelism? In fact, many such programs exist in real life, and the algorithm for solving this problem is useful in its own right. In addition, the concepts used to solve this problem can be extended to handle synchronization and communication.

### 11.7.1 An Introductory Example

Shown in Fig. 11.23 is an excerpt of a C translation (with Fortran-style array accesses retained for clarity) from a 5000-line Fortran multigrid algorithm to solve three-dimensional Euler equations. The program spends most its time in a small number of routines like the one shown in the figure. It is typical of many numerical programs. These often consist of numerous for-loops, with different nesting levels, and they have many array accesses, all of which are affine expressions of surrounding loop indexes. To keep the example short, we have elided lines from the original program with similar characteristics.

The code of Fig. 11.23 operates on the scalar variable  $T$  and a number of different arrays with different dimensions. Let us first examine the use of variable  $T$ . Because each iteration in the loop uses the same variable  $T$ , we cannot execute the iterations in parallel. However,  $T$  is used only as a way to hold a common subexpression used twice in the same iteration. In the first two of the three loop nests in Fig. 11.23, each iteration of the innermost loop writes a value into  $T$  and uses the value immediately after twice, in the same iteration. We can eliminate the dependences by replacing each use of  $T$  by the right-hand-side expression in the previous assignment of  $T$ , without changing the semantics of the program. Or, we can replace the scalar  $T$  by an array. We then have each iteration use its own array element  $T[j, i]$ .

With this modification, the computation of an array element in each assignment statement depends only on other array elements with the same values for the last two components ( $j$  and  $i$ , respectively). We can thus group all

```

for (j = 2; j <= jl;
    for (i = 2, i <= il, i++) {
        AP[j,i] =
        T = 1.0/(1.0 + AP[j,i]);
        D[2,j,i] = T*AP[j,i];
        DW[1,2,j,i] = T*DW[1,2,j,i];
    }
for (k = 3; k <= kl-1; k++)
    for (j = 2; j <= jl; j++)
        for (i = 2; i <= il; i++) {
            AM[j,i] = AP[j,i];
            AP[j,i] = . . . ;
            T = ...AP[j,i] - AM[j,i]*D[k-1,j,i]...;
            D[k,j,i] = T*AP[j,i];
            DW[1,k,j,i] = T*(DW[1,k,j,i] + DW[1,k-1,j,i])...;
        }

for (k = kl-1; k >= 2; k-)
    for (j = 2; j <= jl;
        for (i = 2; i <= il; i++)
            DW[1,k,j,i] = DW[1,k,j,i] + D[k,j,i]*DW[1,k+1,j,i];

```

Figure 11.23: Code excerpt of a multigrid algorithm

operations that operate on the  $(j,i)$ th element of all arrays into one computation unit, and execute them in the original sequential order. This modification produces  $(j_l - 1) \times (i_l - 1)$  units of computation that are all independent of one another. Notice that second and third nests in the source program involve a third loop, with index  $k$ . However, because there is no dependence between dynamic accesses with the same values for  $j$  and  $i$ , we can safely perform the loops on  $k$  inside the loops on  $j$  and  $i$  — that is, within a computation unit.

Knowing that these computation units are independent enables a number of legal transforms on this code. For example, instead of executing the code as originally written, a uniprocessor can perform the same computation by executing the units of independent operation one unit at a time. The resulting code, shown in Fig. 11.24, has improved temporal locality, because results produced are consumed immediately.

The independent units of computation can also be assigned to different processors and executed in parallel, without requiring any synchronization or communication. Since there are  $(j_l - 1) \times (i_l - 1)$  independent units of computation, we can utilize at most  $(j_l - 1) \times (i_l - 1)$  processors. By organizing the processors as if they were in a 2-dimensional array, with ID's  $2 < j < j_l$  and  $2 < i < i_l$ , the SPMD program to be executed by each processor is simply the body in the inner loop in Fig. 11.24.

```

for (j = 2; j <= j1; j++)
  for (i = 2; i <= i1; i++) {
    AP[j,i]      = ...;
    T[j,i]       = 1.0/(1.0 + AP[j,i]);
    D[2,j,i]     = T[j,i]*AP[j,i];
    DW[1,2,j,i]  = T[j,i]*DW[1,2,j,i];
    for (k = 3; k <= k1-1; k++) {
      AM[j,i]    = AP[j,i];
      AP[j,i]    = ...;
      T[j,i]     = ...AP[j,i] - AM[j,i]*D[k-1,j,i]...;
      D[k,j,i]   = T[j,i]*AP[j,i];
      DW[1,k,j,i] = T[j,i]*(DW[1,k,j,i] + DW[1,k-1,j,i])...;
    }

    for (k = k1-1; k >= 2; k-)
      DW[1,k,j,i] = DW[1,k,j,i] + D[k,j,i]*DW[1,k+1,j,i];
  }

```

Figure 11.24: Code of Fig. 11.23 transformed to carry outermost parallel loops

The above example illustrates the basic approach to finding synchronization-free parallelism. We first split the computation into as many independent units as possible. This partitioning exposes the scheduling choices available. We then assign computation units to the processors, depending on the number of processors we have. Finally, we generate an SPMD program that is executed on each processor.

### 11.7.2 Affine Space Partitions

A loop nest is said to have  $k$  degrees of parallelism if it has, within the nest,  $k$  parallelizable loops — that is, loops such that there are no data dependencies between different iterations of the loops. For example, the code in Fig. 11.24 has 2 degrees of parallelism. It is convenient to assign the operations in a computation with  $k$  degrees of parallelism to a processor array with  $k$  dimensions.

We shall assume initially that each dimension of the processor array has as many processors as there are iterations of the corresponding loop. After all the independent computation units have been found, we shall map these "virtual" processors to the actual processors. In practice, each processor should be responsible for a fairly large number of iterations, because otherwise there is not enough work to amortize away the overhead of parallelization.

We break down the program to be parallelized into elementary statements, such as 3-address statements. For each statement, we find an *affine space partition* that maps each dynamic instance of the statement, as identified by its loop indexes, to a processor ID.

Example 11.40: As discussed above, the code of Fig. 11.23 has two degrees of parallelism. We view the processor array as a 2-dimensional space. Let  $(p_i, P_2)$  be the ID of a processor in the array. The parallelization scheme discussed in Section 11.7.1 can be described by simple affine partition functions. All the statements in the first loop nest have this same affine partition:

$$\begin{array}{r} p_i \\ P_2 \end{array} \begin{array}{cc} 1 & 0 \\ 0 & 1 \end{array} +$$

All the statements in the second and third loop nests have the following same affine partition:

$$\begin{array}{r} p_i \\ P_2 \end{array} \begin{array}{ccc} 0 & 1 & 0 \\ 0 & 0 & 1 \end{array} +$$

•

The algorithm to find synchronization-free parallelism consists of three steps:

1. Find, for each statement in the program, an affine partition that maximizes the degree of parallelism. Note that we generally treat the statement, rather than the single access, as the unit of computation. The same affine partition must apply to each access in the statement. This grouping of accesses makes sense, since there is almost always dependence among accesses of the same statement anyway.
2. Assign the resulting independent computation units among the processors, and choose an interleaving of the steps on each processor. This assignment is driven by locality considerations.
3. Generate an SPMD program to be executed on each processor.

We shall discuss next how to find the affine partition functions, how to generate a sequential program that executes the partitions serially, and how to generate an SPMD program that executes each partition on a different processor. After we discuss how parallelism with synchronizations is handled in Sections 11.8 through 11.9.9, we return to Step 2 above in Section 11.10 and discuss the optimization of locality for uniprocessors and multiprocessors.

### 11.7.3 Space-Partition Constraints

To require no communication, each pair of operations that share a data dependence must be assigned to the same processor. We refer to these constraints as "space-partition constraints." Any mapping that satisfies these constraints creates partitions that are independent of one another. Note that such constraints can be satisfied by putting all the operations in a single partition. Unfortunately, that "solution" does not yield any parallelism. Our goal is to create

as many independent partitions as possible while satisfying the space-partition constraints; that is, operations are not placed on the same processor unless it is necessary.

When we restrict ourselves to affine partitions, then instead of maximizing the number of independent units, we may maximize the degree (number of dimensions) of parallelism. It is sometimes possible to create more independent units if we can use *piecewise* affine partitions. A piecewise affine partition divides instances of a single access into different sets and allows a different affine partition for each set. However, we shall not consider such an option here.

Formally, an affine partition of a program is *synchronization free* if and only if for every two (not necessarily distinct) accesses sharing a dependence,  $T_1 = (\mathbf{F}_1, \mathbf{f}_1, \mathbf{B}_1, \mathbf{b}_1)$  in statement  $s_1$  nested in  $d_1$  loops, and  $T_2 = (\mathbf{F}_2, \mathbf{f}_2, \mathbf{B}_2, \mathbf{b}_2)$  in statement  $s_2$  nested in  $d_2$  loops, the partitions  $(\mathbf{C}_1, \mathbf{c}_1)$  and  $(\mathbf{C}_2, \mathbf{c}_2)$  for statements  $s_1$  and  $s_2$ , respectively, satisfy the following *space-partition constraints*:

- For all  $\mathbf{i}_1$  in  $\mathbf{Z}^n$  and  $\mathbf{i}_2$  in  $\mathbf{Z}^n$  such that
  - a)  $\mathbf{B}_1 \mathbf{i}_1 - \mathbf{B}_2 \mathbf{i}_2 > 0$ ,
  - b)  $\mathbf{B}_1 \mathbf{i}_1 + \mathbf{b}_1 > 0$ , and
  - c)  $\mathbf{F}_1 \mathbf{i}_1 + \mathbf{f}_1 = \mathbf{F}_2 \mathbf{i}_2 + \mathbf{f}_2$ ,

it is the case that  $\mathbf{C}_1 \mathbf{i}_1 + \mathbf{c}_1 = \mathbf{C}_2 \mathbf{i}_2 + \mathbf{c}_2$ .

The goal of the parallelization algorithm is to find, for each statement, the partition with the highest rank that satisfies these constraints.

Shown in Fig. 11.25 is a diagram illustrating the essence of the space-partition constraints. Suppose there are two static accesses in two loop nests with index vectors  $\mathbf{i}_1$  and  $\mathbf{i}_2$ . These accesses are dependent in the sense that they access at least one array element in common, and at least one of them is a write. The figure shows particular dynamic accesses in the two loops that happen to access the same array element, according to the affine access functions  $\mathbf{F}_1 \mathbf{i}_1 + \mathbf{f}_1$  and  $\mathbf{F}_2 \mathbf{i}_2 + \mathbf{f}_2$ . Synchronization is necessary unless the affine partitions for the two static accesses,  $\mathbf{C}_1 \mathbf{i}_1 + \mathbf{c}_1$  and  $\mathbf{C}_2 \mathbf{i}_2 + \mathbf{c}_2$ , assign the dynamic accesses to the same processor.

If we choose an affine partition whose rank is the maximum of the ranks of all statements, we get the maximum possible parallelism. However, under this partitioning some processors may be idle at times, while other processors are executing statements whose affine partitions have a smaller rank. This situation may be acceptable if the time taken to execute those statements is relatively short. Otherwise, we can choose an affine partition whose rank is smaller than the maximum possible, as long as that rank is greater than 0.

We show in Example 11.41 a small program designed to illustrate the power of the technique. Real applications are usually much simpler than this, but may have boundary conditions resembling some of the issues shown here. We shall use this example throughout this chapter to illustrate that programs with

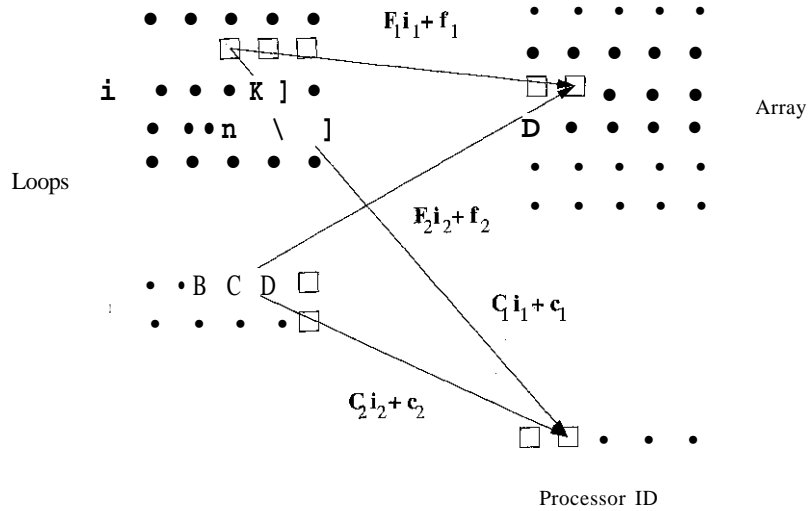

Figure 11.25: Space-partition constraints

affine accesses have relatively simple space-partition constraints, that these constraints can be solved using standard linear algebra techniques, and that the desired SPMD program can be generated mechanically from the affine partitions.

Example 11.41: This example shows how we formulate the space-partition constraints for the program consisting of the small loop nest with two statements,  $s_1$  and  $s_2$ , shown in Figure 11.26.

```

for (i = 1; i <= 100; i++)
  for (j = 1; j <= 100; j++) {
    x[i,j] = x[i,j] + y[i-1,j]; /* (s1) */
    y[i,j] = y[i,j] + x[i,j-1]; /* (s2) */
  }
    
```

Figure 11.26: A loop nest exhibiting long chains of dependent operations

We show the data dependences in the program in Figure 11.27. That is, each black dot represents an instance of statement  $S_1$ , and each white dot represents an instance of statement  $S_2$ . The dot located at coordinates  $(i, j)$  represents the instance of the statement that is executed for those values of the loop indexes. Note, however, that the instance of  $s_2$  is located just below the instance of  $s_1$  for the same  $(i, j)$  pair, so the vertical scale of  $j$  is greater than the horizontal scale of  $i$ .

Notice that  $X[i,j]$  is written by  $s_1(i, j)$ , that is, by the instance of statement  $s_1$  with index values  $i$  and  $j$ . It is later read by  $s_2(i, j + 1)$ , so  $s_1(i, j)$  must



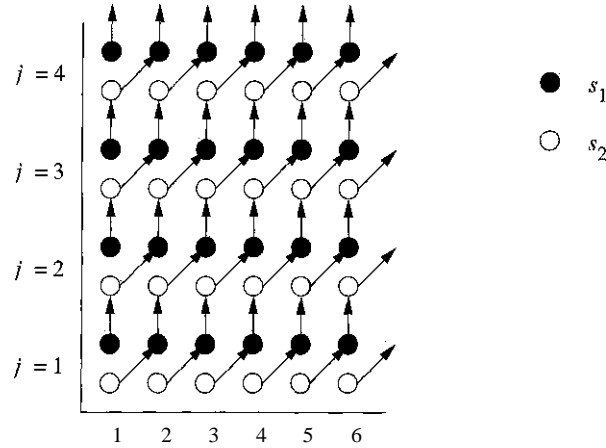

Figure 11.27: Dependences of the code in Example 11.41

precede  $s_1(i, j + 1)$ . This observation explains the vertical arrows from black dots to white dots. Similarly,  $Y[i, j]$  is written by  $s_1(i, j)$  and later read by  $s_2(i + 1, j)$ . Thus,  $s_1(i, j)$  must precede  $s_2(i + 1, j)$ , which explains the arrows from white dots to black.

It is easy to see from this diagram that this code can be parallelized without synchronization by assigning each chain of dependent operations to the same processor. However, it is not easy to write the SPMD program that implements this mapping scheme. While the loops in the original program have 100 iterations each, there are 200 chains, with half originating and ending with statement  $s_1$  and the other half originating and ending with  $s_2$ . The lengths of the chains vary from 1 to 100 iterations.

Since there are two statements, we are seeking two affine partitions, one for each statement. We only need to express the space-partition constraints for one-dimensional affine partitions. These constraints will be used later by the solution method that tries to find all the independent one-dimensional affine partitions and combine them to get multidimensional affine partitions. We can thus represent the affine partition for each statement by a  $1 \times 2$  matrix and a  $1 \times 1$  vector to translate the vector of indexes into a single processor number. Let  $([C_1 C_2], [c_1])$ ,  $([C_1 C_2], [c_2])$ , be the one-dimensional affine partitions for the statements  $s_1$  and  $s_2$ , respectively.

We apply six data dependence tests:

1. Write access  $X[i, j]$  and itself in statement  $s_1$ ,
2. Write access  $X[i, j]$  with read access  $X[i, j]$  in statement  $s_1$ ,
3. Write access  $X[i, j]$  in statement  $s_1$  with read access  $X[i, j - 1]$  in statement  $s_2$ ,

4. Write access  $X[i, j]$  and itself in statement  $s_1$ ,
5. Write access  $Y[i, j]$  with read access  $Y[i, j]$  in statement  $s_1$ ,
6. Write access  $Y[i, j]$  in statement  $s_2$  with read access  $Y[i - 1, j]$  in statement  $s_1$ .

We see that the dependence tests are all simple and highly repetitive. The only dependences present in this code occur in case (3) between instances of accesses  $X[i, j]$  and  $X[i, j - 1]$  and in case (6) between  $Y[i, j]$  and  $Y[i - 1, j]$ .

The space-partition constraints imposed by the data dependence between  $X[i, j]$  in statement  $s_1$  and  $X[i, j - 1]$  in statement  $s_1$  can be expressed in the following terms:

$$\begin{aligned} \text{For all } i, j \text{ and } i', j' \text{ such that} \\ 1 < i < 100 \quad 1 < j < 100 \\ 1 < i' < 100 \quad 1 < j' < 100 \\ i = i' \end{aligned}$$

we have

$$C_{11}i + C_{12}j + C_{13} = C_{21}i' + C_{22}j' + C_{23}$$

That is, the first four conditions say that  $(i, j)$  and  $(i', j')$  lie within the iteration space of the loop nest, and the last two conditions say that the dynamic accesses  $X[i, j]$  and  $X[i', j']$  touch the same array element. We can derive the space-partition constraint for accesses  $Y[i, j]$  in statement  $s_2$  and  $Y[i, j]$  in statement  $s_1$  in a similar manner. •

### 11.7.4 Solving Space-Partition Constraints

Once the space-partition constraints have been extracted, standard linear algebra techniques can be used to find the affine partitions satisfying the constraints. Let us first show how we find the solution to Example 11.41.

Example 11.42 : We can find the affine partitions for Example 11.41 with the following steps:

1. Create the space-partition constraints shown in Example 11.41. We use the loop bounds in determining the data dependences, but they are not used in the rest of the algorithm otherwise.
2. The unknown variables in the equalities are  $i, i', j, j', C_{11}, C_{12}, C_{13}, C_{21}, C_{22}, C_{23}$ . Reduce the number of unknowns by using the equalities due to the access functions:  $i - i' = 0$  and  $j - j' = 1$ . We do so using Gaussian elimination, which reduces the four variables to two: say  $t_1 = i - i'$ , and  $t_2 = j + 1 - j'$ . The equality for the partition becomes

$$[C_{11} - C_{21} \quad C_{12} - C_{22}] \begin{bmatrix} t_1 \\ t_2 \end{bmatrix} + [C_{13} - C_{23} - C_{22}] = 0.$$

3. The equation above holds for all combinations of  $t_1$  and  $t_2$ . Thus, it must be that

$$\begin{aligned} C_{n1} - C_{21} &= 0 \\ C_{n2} - C_{22} &= 0 \\ c_1 - c_2 - C_{22} &= 0. \end{aligned}$$

If we perform the same steps on the constraint between the accesses  $Y[i - l, j]$  and  $Y[i, j]$ , we get

$$\begin{aligned} C_{n1} - C_{21} &= 0 \\ C_{n2} - C_{22} &= 0 \\ c_1 - c_2 + C_{21} &= 0. \end{aligned}$$

Simplifying all the constraints together, we obtain the following relationships:

$$C_{n1} = C_{21} = -C_{22} \quad C_{n2} = c_2 - c_1.$$

4. Find all the independent solutions to the equations involving only unknowns in the coefficient matrix, ignoring the unknowns in the constant vectors in this step. There is only one independent choice in the coefficient matrix, so the affine partitions we seek can have at most a rank of one. We keep the partition as simple as possible by setting  $C_{n1} = 1$ . We cannot assign 0 to  $C_{n1}$  because that will create a rank-0 coefficient matrix, which maps all iterations to the same processor. It then follows that  $C_{21} = 1$ ,  $C_{22} = -1$ ,  $C_{12} = -1$ .
5. Find the constant terms. We know that the difference between the constant terms,  $c_2 - c_1$ , must be  $-1$ . We get to pick the actual values, however. To keep the partitions simple, we pick  $c_2 = 0$ ; thus  $c_1 = -1$ .

Let  $p$  be the ID of the processor executing iteration  $s_i$ . In terms of  $p$ , the affine partition is

$$s_i : [p] = [1 \ -1] \mathbf{i} + [-1] \mathbf{j};$$

$$\delta_{>}: [p] = [l \ -1] \mathbf{j} + [0]$$

That is, the  $(i, j)$ th iteration of  $s_i$  is assigned to the processor  $p = i - j - 1$ , and the  $(i, j)$ th iteration of  $s_j$  is assigned to processor  $p = l - j$ .

**Algorithm 11.43:** Finding a highest-ranked synchronization-free affine partition for a program.

**INPUT:** A program with affine array accesses.

**OUTPUT:** A partition.

**METHOD:** Do the following:

1. Find all data-dependent pairs of accesses in a program for each pair of data-dependent accesses,  $T_1 = (F_1, f_1, B_1, b_1)$  in statement  $s_1$  nested in  $d_1$  loops and  $T_2 = (F_2, f_2, B_2, b_2)$  in statement  $s_2$  nested in  $d_2$  loops. Let  $(C_1, c_1)$  and  $(C_2, c_2)$  represent the (currently unknown) partitions of statements  $s_1$  and  $s_2$ , respectively. The space-partition constraints state that if

$$F_1 i_1 + f_1 = F_2 i_2 + f_2$$

then

$$C_1 i_1 + c_1 = C_2 i_2 + c_2$$

for all  $i_1$  and  $i_2$ , within their respective loop bounds. We shall generalize the domain of iterations to include all  $i_1$  in  $Z^n$  and  $i_2$  in  $Z^m$ ; that is, the bounds are all assumed to be minus infinity to infinity. This assumption makes sense, since an affine partition cannot make use of the fact that an index variable can take on only a limited set of integer values.

2. For each pair of dependent accesses, we reduce the number of unknowns in the index vectors.
  - (a) Note that  $F_1 i_1 + f_1$  is the same vector as

$$F \begin{bmatrix} i_1 \\ 1 \end{bmatrix} - f_1$$

That is, by adding an extra component 1 at the bottom of column-vector  $i_1$ , we can make the column-vector  $f_1$  be an additional, last column of the matrix  $F$ . We may thus rewrite the equality of the access functions  $F_1 i_1 + f_1 = F_2 i_2 + f_2$  as

$$\begin{bmatrix} F_1 & -f_2 & (f_1 - f_2) \end{bmatrix} \begin{bmatrix} i_1 \\ i_2 \\ 1 \end{bmatrix} = 0.$$

- (b) The above equations will in general have more than one solution. However, we may still use Gaussian elimination to solve the equations for the components of  $i_1$  and  $i_2$  as best we can. That is, eliminate as many variables as possible until we are left with only variables that cannot be eliminated. The resulting solution for  $i_1$  and  $i_2$  will have the form

where  $U$  is an upper-triangular matrix and  $t$  is a vector of free variables ranging over all integers.

- (c) We may use the same trick as in Step (2a) to rewrite the equality of the partitions. Substituting the vector  $(i, i_2, 1)$  with the result from Step (2b), we can write the constraints on the partitions as

$$; c_i - c_{i_2} (c_i - c_{i_2}) ] U = 0.$$

3. Drop the nonpartition variables. The equations above hold for all combinations of  $t$  if

$$[ C_i - C_{i_2} (c_i - c_{i_2}) ] U = \mathbf{0}.$$

Rewrite these equations in the form  $Ax = \mathbf{0}$ , where  $x$  is a vector of all the unknown coefficients of the affine partitions.

4. Find the rank of the affine partition and solve for the coefficient matrices. Since the rank of an affine partition is independent of the value of the constant terms in the partition, we eliminate all the unknowns that come from the constant vectors like  $c_i$  or  $c_{i_2}$ , thus replacing  $Ax = \mathbf{0}$  by simplified constraints  $A'x' = \mathbf{0}$ . Find the solutions to  $A'x' = \mathbf{0}$ , expressing them as  $B$ , a set of basis vectors spanning the null space of  $A'$ .
5. Find the constant terms. Derive one row of the desired affine partition from each basis vector in  $B$ , and derive the constant terms using  $Ax = \mathbf{0}$ .

Note that Step 3 ignores the constraints imposed by the loop bounds on variables  $t$ . The constraints are only stricter as a result, and the algorithm must therefore be safe. That is, we place constraints on the  $C$ 's and  $c$ 's assuming  $t$  is arbitrary. Conceivably, there would be other solutions for the  $C$ 's and  $c$ 's that are valid only because some values of  $t$  are impossible. Not searching for these other solutions may cause us to miss an optimization, but cannot cause the program to be changed to a program that does something different from what the original program does.

### 11.7.5 A Simple Code-Generation Algorithm

Algorithm 11.43 generates affine partitions that split computations into independent partitions. Partitions can be assigned arbitrarily to different processors, since they are independent of one another. A processor may be assigned more than one partition and can interleave the execution of its partitions, as long as operations within each partition, which normally have data dependences, are executed sequentially.

It is relatively easy to generate a correct program given an affine partition. We first introduce Algorithm 11.45, a simple approach to generating code for a single processor that executes each of the independent partitions sequentially. Such code optimizes temporal locality, since array accesses that have several uses are very close in time. Moreover, the code easily can be turned into an SPMD program that executes each partition on a different processor. The code generated is, unfortunately, inefficient; we shall next discuss optimizations to make the code execute efficiently.

The essential idea is as follows. We are given bounds for the index variables of a loop nest, and we have determined, in Algorithm 11.43, a partition for the accesses of a particular statement  $s$ . Suppose we wish to generate sequential code that performs the action of each processor sequentially. We create an outermost loop that iterates through the processor IDs. That is, each iteration of this loop performs the operations assigned to a particular processor ID. The original program is inserted as the loop body of this loop; in addition, a test is added to guard each operation in the code to ensure that each processor only executes the operations assigned to it. In this way, we guarantee that the processor executes all the instructions assigned to it, and does so in the original sequential order.

**Example 11.44:** Let us generate code that executes the independent partitions in Example 11.41 sequentially. The original sequential program is from Fig. 11.26 is repeated here as Fig. 11.28.

```

for (i = 1; i <= 100; i++)
  for (j = 1; j <= 100;      {
    X[i,j] = X[i,j] + Y[i-1,j]; /* (s1) */
    Y[i,j] = Y[i,j] + X[i,j-1]; /* (s2) */
  }

```

Figure 11.28: Repeat of Fig. 11.26

In Example 11.41, the affine partitioning algorithm found one degree of parallelism. Thus, the processor space can be represented by a single variable  $p$ . Recall also from that example that we selected an affine partition that, for all values of index variables  $i$  and  $j$  with  $1 < i < 100$  and  $1 < j < 100$ , assigned

1. Instance  $(i, j)$  of statement  $s_1$  to processor  $p = i - j - 1$ , and
2. Instance  $(i, j)$  of statement  $s_2$  to processor  $p = i - j$ .

We can generate the code in three steps:

1. For each statement, find all the processor IDs participating in the computation. We combine the constraints  $1 < i < 100$  and  $1 < j < 100$  with one of the equations  $p = i - j - 1$  or  $p = i - j$ , and project away  $i$  and  $j$  to get the new constraints

- (a)  $-100 < p < 98$  if we use the function  $p = i - j - 1$  that we get for statement  $s_1$ , and
  - (b)  $-99 < p < 99$  if we use  $p = i - j$  from statement  $s_2$ .
2. Find all the processor IDs participating in any of the statements. When we take the union of these ranges, we get  $-100 < p < 99$ ; these bounds are sufficient to cover all instances of both statements  $s_1$  and  $s_2$ .
  3. Generate the code to iterate through the computations in each partition sequentially. The code, shown in Fig. 11.29, has an outer loop that iterates through all the partition IDs participating in the computation (line (1)). Each partition goes through the motion of generating the indexes of all the iterations in the original sequential program in lines (2) and (3) so that it can pick out the iterations the processor  $p$  is supposed to execute. The tests of lines (4) and (6) make sure that statements  $s_1$  and  $s_2$  are executed only when the processor  $p$  would execute them.

The generated code, while correct, is extremely inefficient. First, even though each processor executes computation from at most 99 iterations, it generates loop indexes for  $100 \times 100$  iterations, an order of magnitude more than necessary. Second, each addition in the innermost loop is guarded by a test, creating another constant factor of overhead. These two kinds of inefficiencies are dealt with in Sections 11.7.6 and 11.7.7, respectively. •

```

1)   for (p = -100; p <= 99; p++)
2)       for (i = 1; i <= 100; i++)
3)           for (j = 1; j <= 100; j++) {
4)               if (p == i-j-1)
5)                   x[i,j] = x[i,j] + y[i-1,j]; /* (s1) */
6)               if (p == i-j)
7)                   y[i,j] = x[i,j-1] + y[i,j]; /* (s2) */
8)           }

```

Figure 11.29: A simple rewriting of Fig. 11.28 that iterates over processor space

Although the code of Fig. 11.29 appears designed to execute on a uniprocessor, we could take the inner loops, lines (2) through (8), and execute them on 200 different processors, each of which had a different value for  $p$ , from  $-100$  to 99. Or, we could partition the responsibility for the inner loops among any number of processors less than 200, as long as we arranged that each processor knew what values of  $p$  it was responsible for and executed lines (2) through (8) for just those values of  $p$ .

Algorithm 11.45: Generating code that executes partitions of a program sequentially.

**INPUT:** A program  $P$  with affine array accesses. Each statement  $s$  in the program has associated bounds of the form  $\mathbf{B}_s \mathbf{i} + \mathbf{b}_s > 0$ , where  $\mathbf{i}$  is the vector of loop indexes for the loop nest in which statement  $s$  appears. Also associated with statement  $s$  is a partition  $\mathbf{C}_s \mathbf{i} + \mathbf{c}_s = \mathbf{p}$  where  $\mathbf{p}$  is an  $m$ -dimensional vector of variables representing a processor ID;  $m$  is the maximum, over all statements in program  $P$ , of the rank of the partition for that statement.

**OUTPUT:** A program equivalent to  $P$  but iterating over the processor space rather than over loop indexes.

**METHOD:** Do the following:

1. For each statement, use Fourier-Motzkin elimination to project out all the loop index variables from the bounds.
2. Use Algorithm 11.13 to determine bounds on the partition ID's.
3. Generate loops, one for each of the  $m$  dimensions of processor space. Let  $\mathbf{p} = [p_1, p_2, \dots, p_m]$  be the vector of variables for these loops; that is, there is one variable for each dimension of the processor space. Each loop variable  $p_i$  ranges over the union of the partition spaces for all statements in the program  $P$ .

Note that the union of the partition spaces is not necessarily convex. To keep the algorithm simple, instead of enumerating only those partitions that have a nonempty computation to perform, set the lower bound of each  $p_i$  to the minimum of all the lower bounds imposed by all statements and the upper bound of each  $p_i$  to the maximum of all the upper bounds imposed by all statements. Some values of  $\mathbf{p}$  may thereby have no operations.

The code to be executed by each partition is the original sequential program. However, every statement is guarded by a predicate so that only those operations belonging to the partition are executed. •

An example of Algorithm 11.45 will follow shortly. Bear in mind, however, that we are still far from the optimal code for typical examples.

### 11.7.6 Eliminating Empty Iterations

We now discuss the first of the two transformations necessary to generate efficient SPMD code. The code executed by each processor cycles through all the iterations in the original program and picks out the operations that it is supposed to execute. If the code has  $k$  degrees of parallelism, the effect is that each processor performs  $k$  orders of magnitude more work. The purpose of the first transformation is to tighten the bounds of the loops to eliminate all the empty iterations.

We begin by considering the statements in the program one at a time. A statement's iteration space to be executed by each partition is the original iteration space plus the constraint imposed by the affine partition. We can generate



tight bounds for each statement by applying Algorithm 11.13 to the new iteration space; the new index vector is like the original sequential index vector, with processor ID's added as outermost indexes. Recall that the algorithm will generate tight bounds for each index in terms of surrounding loop indexes.

After finding the iteration spaces of the different statements, we combine them, loop by loop, making the bounds the union of those for each statement. Some loops end up having a single iteration, as illustrated by Example 11.46 below, and we can simply eliminate the loop and simply set the loop index to the value for that iteration.

Example 11.46: For the loop of Fig. 11.30(a), Algorithm 11.43 will create the affine partition

$$\begin{aligned} S \setminus : p &= i \\ s_i : p &= j \end{aligned}$$

Algorithm 11.45 will create the code of Fig. 11.30(b). Applying Algorithm 11.13 to statement  $s \setminus$  produces the bound:  $p < i < p$ , or simply  $\% = p$ . Similarly, the algorithm determines  $j = p$  for statement  $s_i$ . Thus, we get the code of Fig. 11.30(c). Copy propagation of variables  $i$  and  $j$  will eliminate the unnecessary test and produce the code of Fig. 11.30(d). •

We now return to Example 11.44 and illustrate the step to merge multiple iteration spaces from different statements together.

Example 11.47: Let us now tighten the loop bounds of the code in Example 11.44. The iteration space executed by partition  $p$  for statement  $s_i$  is defined by the following equalities and inequalities:

$$\begin{aligned} -100 &< p < 99 \\ 1 &< i < 100 \\ 1 &< j < 100 \\ i - p - 1 &= j \end{aligned}$$

Applying Algorithm 11.13 to the above creates the constraints shown in Fig. 11.31(a). Algorithm 11.13 generates the constraint  $p + 2 < i < 100 + p + 1$  from  $i - p - 1 = j$  and  $1 < j < 100$ , and tightens the upper bound of  $p$  to 98. Likewise, the bounds for each of the variables for statement  $s_i$  are shown in Fig. 11.31(b).

The iteration spaces for  $s_i$  and  $s_j$  in Fig. 11.31 are similar, but as expected from Fig. 11.27, certain limits differ by 1 between the two. The code in Fig. 11.32 executes over this union of iteration spaces. For example, for  $i$  use  $\min(1, \text{L} > +1)$  as the lower bound and  $\max(100, 100 + p + 1)$  as the upper bound. Note that the innermost loop has 2 iterations except that it has only one the first and last time it is executed. The overhead in generating loop indexes is thus reduced by an order of magnitude. Since the iteration space executed is larger than either that of  $s_i$  and  $s_j$ , conditionals are still necessary to select when these statements are executed. •

```

for (i=1; i<=N; i++)
  Y[i] = Z[i]; /* (s1) */
for (j=1; j<=N; j++)
  X[j] = Y[j]; /* (s2) */

```

(a) Initial code.

```

for (p=1; p<=N; p++) {
  for (i=1; i<=N; i++)
    if (p == i)
      Y[i] = Z[i]; /* (s1) */
  for (j=1; j<=N; j++)
    if (p == j)
      X[j] = Y[j]; /* (s2) */
}

```

(b) Result of applying Algorithm 11.45.

```

for (p=1; p<=N; p++) {
  i = p;
  if (p == i)
    Y[i] = Z[i]; /* (s1) */
  j = p;
  if (p == j)
    X[j] = Y[j]; /* (s2) */
}

```

(c) After applying Algorithm 11.13.

```

for (p=1; p<=N; p++) {
  Y[p] = Z[p]; /* (s1) */
  X[p] = Y[p]; /* (s2) */
}

```

(d) Final code.

Figure 11.30: Code for Example 11.46

$$\begin{array}{l}
 3 \bullet \quad i - p - 1 < 3 < i - p - 1 \\
 \quad \quad \quad 1 < 3 < 100 \\
 \\
 i : \quad p + 2 < i < 100 + \wedge + 1 \\
 \quad \quad \quad 1 < i < 100 \\
 \\
 p : \quad -100 < p < 98
 \end{array}$$

(a) Bounds for statement  $s_{\pm}$ 

$$\begin{array}{l}
 3 \bullet \quad i - p < 3 < i - p \\
 \quad \quad \quad 1 < 3 < 100 \\
 \\
 i : \quad p + 1 < i < 100 + p \\
 \quad \quad \quad 1 < i < 100 \\
 \\
 p : \quad -99 < p < 99
 \end{array}$$

(b) Bounds for statement  $s_{\pm}$ Figure 11.31: Tighter bounds on  $p$ ,  $i$ , and  $j$  for Fig. 11.29

### 11.7.7 Eliminating Tests from Innermost Loops

The second transformation is to remove conditional tests from the inner loops. As seen from the examples above, conditional tests remain if the iteration spaces of statements in the loop intersect but not completely. To avoid the need for conditional tests, we split the iteration space into subspaces, each of which executes the same set of statements. This optimization requires code to be duplicated and should only be used to remove conditionals in the inner loops.

To split an iteration space to reduce tests in inner loops, we apply the following steps repeatedly until we remove all the tests in the inner loops:

1. Select a loop that consists of statements with different bounds.
2. Split the loop using a condition such that some statement is excluded from at least one of its components. We choose the condition from among the boundaries of the overlapping different polyhedra. If some statement has all its iterations in only one of the half planes of the condition, then such a condition is useful.
3. Generate code for each of these iteration spaces separately.

**Example 11.48:** Let us remove the conditionals from the code of Fig. 11.32. Statements  $s_i$  and  $s_2$  are mapped to the same set of partition ID's except for

```

for (p = -100; p <= 99; p++)
  for (i = max(1,p+1); i <= min(100,101+p); i++)
    for (j = max(1,i-p-1); j <= min(100,i-p); j++) {
      if (p == i-j-1)
        X[i,j] = X[i,j-1] + Y[i-1,j]; /* (s1) */
      if (p == i-j)
        Y[i,j] = X[i,j-1] + Y[i,j]; /* (s2) */
    }

```

Figure 11.32: Code of Fig. 11.29 improved by tighter loop bounds

the boundary partitions at either end. Thus, we separate the partition space into three subspaces:

1.  $p = -100$ ,
2.  $-99 < p < 98$ , and
3.  $p = 99$ .

The code for each subspace can then be specialized for the value(s) of  $p$  contained. Figure 11.33 shows the resulting code for each of the three iteration spaces.

Notice that the first and third spaces do not need loops on  $i$  or  $j$ , because for the particular value of  $p$  that defines each space, these loops are degenerate; they have only one iteration. For example, in space (1), substituting  $p = -100$  in the loop bounds restricts  $i$  to 1, and subsequently  $j$  to 100. The assignments to  $p$  in spaces (1) and (3) are evidently dead code and can be eliminated.

Next we split the loop with index  $i$  in space (2). Again, the first and last iterations of loop index  $i$  are different. Thus, we split the loop into three subspaces:

- a)  $\max(1, p+1) < i < p+2$ , where only  $s_1$  is executed,
- b)  $\max(1, p+2) < i < \min(100, 100+p)$ , where both  $s_1$  and  $s_2$  are executed, and
- c)  $101+p < i < \min(101+p, 100)$ , where only  $s_2$  is executed.

The loop nest for space (2) in Fig. 11.33 can thus be written as in Fig. 11.34(a).

Figure 11.34(b) shows the optimized program. We have substituted Fig. 11.34(a) for the loop nest in Fig. 11.33. We also propagated out assignments to  $p$ ,  $i$ , and  $j$  into the array accesses. When optimizing at the intermediate-code level, some of these assignments will be identified as common subexpressions and re-extracted from the array-access code. •

```

/* space (1) */
p = -100;
i = 1;
j = 100;
X[i,j] = X[i,j] + Y[i-1,j]; /* (s1) */

/* space (2) */
for (p = -99; p <= 98; p++)
  for (i = max(1,p+1); i <= min(100,101+p); i++)
    for (j = max(1,i-p-1); j <= min(100,i-p); j++) {
      if (p == i-j-i)
        X[i,j] = X[i,j] + Y[i-1,j]; /* (s1) */
      if (p == i-j)
        Y[i,j] = X[i,j-1] + Y[i,j]; /* (s2) */
    }

/* space (3) */
p = 99;
i = 100;
j = i;

Y[i,j] = X[i,j-1] + Y[i,j]; /* (s2) */

```

Figure 11.33: Splitting the iteration space on the value of  $p$ 

### 11.7.8 Source-Code Transforms

We have seen how we can derive from simple affine partitions for each statement programs that are significantly different from the original source. It is not apparent from the examples seen so far how affine partitions correlate with changes at the source level. This section shows that we can reason about source code changes relatively easily by breaking down affine partitions into a series of primitive transforms.

#### Seven Primitive Affine Transforms

Every affine partition can be expressed as a series of primitive affine transforms, each of which corresponds to a simple change at the source level. There are seven kinds of primitive transforms: the first four primitives are illustrated in Fig. 11.35, the last three, also known as *unimodular transforms*, are illustrated in Fig. 11.36.

The figure shows one example for each primitive: a source, an affine partition, and the resulting code. We also draw the data dependences for the code before and after the transforms. From the data dependence diagrams, we see that each primitive corresponds to a simple geometric transform and induces a relatively simple code transform. The seven primitives are:

```

/* space (2) */
for (p = -99; p <= 98; p++) {
  /* space (2a) */
  if (p >= 0) {
    i = p+1;
    J = U
    Y[i,j] = X[i,j-1] + Y[i,j]; /* (s2) */
  }
  /* space (2b) */
  for (i = max(1,p+2); i <= min(100,100+p); i++) {
    j = i-p-i;
    X[i,j] = X[i,j] + Y[i-1,j]; /* (si) */
    j = i-p-5
    Y[i,j] = X[i,j-1] + Y[i,j]; /* (s2) */
  }
  /* space (2c) */
  if (p <= -1) {
    i = 101+p;
    j = 100;
    X[i,j] = X[i,j] + Y[i-1,j]; /* (si) */
  }
}

```

(a) Splitting space (2) on the value of  $i$ .

```

/* space (1); p = -100 */
X[1,100] = X[1,100] + Y[0,100]; /* (si) */

/* space (2) */
for (p = -99; p <= 98; p++) {
  if (p >= 0)
    Y[p+1,1] = X[p+1,0] + Y[p+1,1]; /* (s2) */
  for (i = max(1,p+2); i <= min(100,100+p); i++) {
    X[i,i-p-1] = X[i,i-p-1] + Y[i-1,i-p-1]; /* (si) */
    Y[i,i-p] = X[i,i-p-1] + Y[i,i-p]; /* (s2) */
  }
  if (p <= -1)
    X[101+p,100] = X[101+p,100] + Y[101+p-1,100]; /* (si) */
}
/* space (3); p = 99 */
Y[100,1] = X[100,0] + Y[100,1]; /* (s2) */

```

(b) Optimized code equivalent to Fig. 11.28.

Figure 11.34: Code for Example 11.48

SOURCE CODE	PARTITION	TRANSFORMED CODE
<pre> for (i=1; i&lt;=N; i++)   Y[i] = Z[i]; /*s1*/ for (j=1; j&lt;=N; j++)   X[j] = Y[j]; /*s2*/ </pre>	<pre> Fusion s<sub>1</sub>:p = i S2-P = j </pre>	<pre> for (p=1; p&lt;=N; p++){   Y[p] = Z[p];   X[p] = Y[p]; } 0 0 0 0 0 0 i </pre>
<p>© © © • t t t *2</p>		<p>*2</p>
<pre> for (p=1; p&lt;=M; p++){   Y[p] = Z[p];   X[p] = Y[p]; } </pre>	<pre> Fission s<sub>1</sub> : i = p S2 * j = P </pre>	<pre> for (i=1; i&lt;=N; i++)   Y[i] = Z[i]; /*s1*/ for (j=1; j&lt;=N; j++)   X[j] = Y[j]; /*s2*/ </pre>
<p>" 0 0 0 i</p>		<p>- 0 0 0 0 Q i</p>
<p>*2</p>		<p>t t t *2</p>
<pre> for (i=1; i&lt;=N; i++) {   Y[i] = Z[i]; /*s1*/   X[i] = Y[i-1]; /*s2*/ } </pre>	<pre> Re-indexing s<sub>1</sub> : p = i s<sub>2</sub> : p = i - 1 </pre>	<pre> if (N&gt;=1) X[1]=Y[0]; for (p=i; p&lt;=N-1; p++){   Y[p]=Z[p];   X[p+1]=Y[p]; } if (N&gt;=1) Y[N]=Z[N]; </pre>
<p>Q o *i</p>		<p>o o o o o o</p>
<p>*2</p>		<p>*2</p>
<pre> for (i=1; i&lt;=N; i++)   Y[2*i] = Z[2*i]; /*s1*/ for (j=1; j&lt;=2N; j++)   X[j]=Y[j]; /*s2*/ </pre>	<pre> Scaling s<sub>1</sub> : p = 2 * i (S2 * P = j) </pre>	<pre> for (p=1; p&lt;=2*N; p++){   if (p mod 2 == 0)     Y[p] = ZCp];   X[p] = Y[p]; } </pre>
<p># ● ● ● ● ● *2</p>		<p>i</p>
		<p>*2</p>

Figure 11.35: Primitive affine transforms (I)

SOURCE CODE	PARTITION	TRANSFORMED CODE
<pre> for (i=0; i&lt;=N; i++)   Y[N-i] = Z[i]; /*s1*/ for (j=0; j&lt;=N; j++)   X[j] = Y[j]; /*s2*/ </pre>	<p style="text-align: center;">Reversal</p> $si : p = N - i$ $(S2-P = j)$	<pre> for (p=0; p&lt;=N; p++)   Y[p] = Z[N-p];   X[p] = Y[p]; } </pre>
		*2
<pre> for (i=1; i&lt;=N; i++)   for (j=0; j&lt;=M; j++)     Z[i,j] =       Z[i-1,j]; </pre>	<p style="text-align: center;">Permutation</p> $\left  p \right  \left  \begin{array}{cc} 0 & 1 \\ 1 & 0 \end{array} \right  \left  i \right $	<pre> for (p=0; p&lt;=M; p++)   for (q=1; q&lt;=N; i++)     Z[q,p] = Z[q-1,p] </pre> <p style="text-align: center;">O - K )</p> <p style="text-align: center;">  . .   ●</p> <hr style="width: 50px; margin-left: auto; margin-right: 0;"/>
<pre> for (i=1; i&lt;=N+M-1; i++)   for (j=max(1,i-N);         j&lt;=min(i,M); j++)     Z[i,j] =       Z[i-1,j-1]; </pre>	<p style="text-align: center;">Skewing</p> $\left  p \right  \left  \begin{array}{cc} 1 & -1 \\ 0 & 1 \end{array} \right  \left  i \right $ <p style="text-align: center;">+</p>	<pre> for (p=1; p&lt;=N; p++)   for (q=1; q&lt;=M; q++)     Z[p,q-p] =       Z[p-1,q-p-1] </pre> <p style="text-align: center;">O - K )</p> <p style="text-align: center;">O - K )</p> <p style="text-align: center;">O K )</p> <hr style="width: 50px; margin-left: auto; margin-right: 0;"/>

Figure 11.36: Primitive affine transforms (II)



## Unimodular Transforms

A unimodular transform is represented by just a unimodular coefficient matrix and no constant vector. A *unimodular matrix* is a square matrix whose determinant is  $\pm 1$ . The significance of a unimodular transform is that it maps an n-dimensional iteration space to another n-dimensional polyhedron, where there is a one-to-one correspondence between iterations of the two spaces.

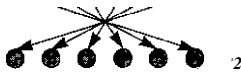
1. *Fusion*. The fusion transform is characterized by mapping multiple loop indexes in the original program to the same loop index. The new loop fuses statements from different loops.
2. *Fission*. Fission is the inverse of fusion. It maps the same loop index for different statements to different loop indexes in the transformed code. This splits the original loop into multiple loops.
3. *Re-indexing*. Re-indexing shifts the dynamic executions of a statement by a constant number of iterations. The affine transform has a constant term.
4. *Scaling*. Consecutive iterations in the source program are spaced apart by a constant factor. The affine transform has a positive nonunit coefficient.
5. *Reversal*. Execute iterations in a loop in reverse order. Reversal is characterized by having  $-1$  as a coefficient.
6. *Permutation*. Permute the inner and outer loops. The affine transform consists of permuted rows of the identity matrix.
7. *Shewing*. Iterate through the iteration space in the loops at an angle. The affine transform is a unimodular matrix with 1's on the diagonal.

### A Geometric Interpretation of Parallelization

The affine transforms shown in all but the fission example are derived by applying the synchronization-free affine partition algorithm to the respective source codes. (We shall discuss how fission can parallelize code with synchronization in the next section.) In each of the examples, the generated code has an (outer-most) parallelizable loop whose iterations can be assigned to different processors and no synchronization is necessary.

These examples illustrate that there is a simple geometric interpretation of how parallelization works. Dependence edges always point from an earlier instance to a later instance. So, dependences between separate statements not nested in any common loop follows the lexical order; dependences between

statements nested in the same loop follows the lexicographic order. Geometrically, dependences of a two-dimensional loop nest always point within the range  $[0^\circ, 180^\circ)$ , meaning that the angle of the dependence must be below  $180^\circ$ , but no less than  $0^\circ$ .

The affine transforms change the ordering of iterations such that all the dependences are found only between operations nested within the same iteration of the outermost loop. In other words, there are no dependence edges at the boundaries of iterations in the outermost loop. We can parallelize simple source codes by drawing their dependences and finding such transforms geometrically.

### 11.7.9 Exercises for Section 11.7

**Exercise 11.7.1:** For the following loop

```
for (i = 2; i < 100; i++)
    A[i] = A[i-2];
```

- What is the largest number of processors that can be used effectively to execute this loop?
- Rewrite the code with processor  $p$  as a parameter.
- Set up and find one solution to the space-partition constraints for this loop.
- What is the affine partition of highest rank for this loop?

**Exercise 11.7.2:** Repeat Exercise 11.7.1 for the loop nests in Fig. 11.37.

**Exercise 11.7.3:** Rewrite the following code

```
for (i = 0; i < 100; i++)
    A[i] = 2*A[i];
for (j = 0; j < 100; j++)
    A[j] = A[j] + 1;
```

so it consists of a single loop. Rewrite the loop in terms of a processor number  $p$  so the code can be partitioned among 100 processors, with iteration  $p$  executed by processor  $p$ .

**Exercise 11.7.4:** In the following code

```
for (i = 1; i < 100; i++)
    for (j = 1; j < 100; j++)
/* (s) */    A[i,j] =
                (A[i-1,j] + A[i+1,j] + A[i,j-1] + A[i,j+1])/4;
```

```

for (i = 0; i <= 97; i++)
    A[i] = A[i+2];

```

(a)

```

for (i = 1; i <= 100; i++)
    for (j = 1; j <= 100; j++)
        for (k = 1; k <= 100; k++) {
            A[i,j,k] = A[i,j,k] + B[i-1,j,k];
            B[i,j,k] = B[i,j,k] + C[i,j-1,k];
            C[i,j,k] = C[i,j,k] + A[i,j,k-1];
        }

```

!(b)

```

for (i = 1; i <= 100; i++)
    for (j = 1; j <= 100; j++)
        for (k = 1; k <= 100; k++) {
            A[i,j,k] = A[i,j,k] + B[i-1,j,k];
            B[i,j,k] = B[i,j,k] + A[i,j-1,k];
            C[i,j,k] = C[i,j,k] + A[i,j,k-1] + B[i,j,k];
        }

```

!(c)

Figure 11.37: Code for Exercise 11.7.2

the only constraints are that the statement  $s$  that forms the body of the loop nest must execute iterations  $s(i - 1, j)$  and  $s(i, j - 1)$  before executing iteration  $s(i, j)$ . Verify that these are the only necessary constraints. Then rewrite the code so that the outer loop has index variable  $p$ , and on the  $p$ th iteration of the outer loop, all instances of  $s(i, j)$  such that  $i + j = p$  are executed.

**Exercise 11.7.5:** Repeat Exercise 11.7.4, but arrange that on the  $p$ th iteration of the outer loop, instances of  $s$  such that  $i - j = p$  are executed.

! **Exercise 11.7.6:** Combine the following loops

```

for (i = 0; i < 100; i++)
    A[i] = B[i];
for (j = 98; j >= 0; j = j-2)
    B[i] = i;

```

into a single loop, preserving all dependencies.

Exercise **11.7.7**: Show that the matrix

$$\begin{pmatrix} 2 & 1 \\ 1 & 1 \end{pmatrix}$$

is unimodular. Describe the transformation it performs on a two-dimensional loop nest.

Exercise **11.7.8**: Repeat Exercise 11.7.7 on the matrix

$$\begin{pmatrix} 1 & 3 \\ 2 & 5 \end{pmatrix}$$

## 11.8 Synchronization Between Parallel Loops

Most programs have no parallelism if we do not allow processors to perform any synchronizations. But adding even a small constant number of synchronization operations to a program can expose more parallelism. We shall first discuss parallelism made possible by a constant number of synchronizations in this section and the general case, where we embed synchronization operations in loops, in the next.

### 11.8.1 A Constant Number of Synchronizations

Programs with no synchronization-free parallelism may contain a sequence of loops, some of which are parallelizable if they are considered independently. We can parallelize such loops by introducing synchronization barriers before and after their execution. Example 11.49 illustrates the point.

```

for (i = 1; i < n; i++)
    for (j = 0; j < n; j++)
        X[i,j] = f(X[i,j] + X[i-1,j]);
for (i = 0; i < n; i++)
    for (j = 1; j < n;
        X[i,j] = g(X[i,j] + X[i,j-1]);

```

Figure 11.38: Two sequential loop nests

Example **11.49**: In Fig. 11.38 is a program representative of an ADI (Alternating Direction Implicit) integration algorithm. There is no synchronization-free parallelism. Dependences in the first loop nest require that each processor works on a column of array  $X$ ; however, dependences in the second loop nest require that each processor works on a row of array  $X$ . For there to be no communication, the entire array has to reside on the same processor, hence there

is no parallelism. We observe, however, that both loops are independently parallelizable.

One way to parallelize the code is to have different processors work on different columns of the array in the first loop, synchronize and wait for all processors to finish, and then operate on the individual rows. In this way, all the computation in the algorithm can be parallelized with the introduction of just one synchronization operation. However, we note that while only one synchronization is performed, this parallelization requires almost all the data in matrix  $X$  to be transferred between processors. It is possible to reduce the amount of communication by introducing more synchronizations, which we shall discuss in Section 11.9.9. •

It may appear that this approach is applicable only to programs consisting of a sequence of loop nests. However, we can create additional opportunities for the optimization through code transforms. We can apply loop fission to decompose loops in the original program into several smaller loops, which can then be parallelized individually by separating them with barriers. We illustrate this technique with Example 11.50.

Example 11.50: Consider the following loop:

```
for (i=1; i<=n; i++) {
    x[i] = y[i] + z[i];    /* (s1) */
    W[A[i]] = x[i];      /* (s2) */
}
```

Without knowledge of the values in array  $A$ , we must assume that the access in statement  $s_2$  may write to any of the elements of  $W$ . Thus, the instances of  $S2$  must be executed sequentially in the order they are executed in the original program.

There is no synchronization-free parallelism, and Algorithm 11.43 will simply assign all the computation to the same processor. However, at the least, instances of statement  $s_1$  can be executed in parallel. We can parallelize part of this code by having different processors perform different instances of statement  $s_1$ . Then, in a separate sequential loop, one processor, say numbered 0, executes  $s_2$ , as in the SPMD code shown in Fig. 11.39. •

## 11.8.2 Program-Dependence Graphs

To find all the parallelism made possible by a constant number of synchronizations, we can apply fission to the original program greedily. Break up loops into as many separate loops as possible, and then parallelize each loop independently.

To expose all the opportunities for loop fission, we use the abstraction of a *program-dependence graph* (PDG). A program dependence graph of a program

```

X[p] = Y[p] + Z[p];    /* (s1) */
/* synchronization barrier */
if (p == 0)
  for (i=1; i<=n; i++)
    W[A[i]] = X[i];    /* (s2) */

```

Figure 11.39: SPMD code for the loop in Example 11.50, with  $p$  being a variable holding the processor ID

is a graph whose nodes are the assignment statements of the program and whose edges capture the data dependences, and the directions of the data dependence, between statements. An edge from statement  $s_1$  to statement  $s_2$  exists whenever some dynamic instance of  $s_1$  shares a data dependence with a *later* dynamic instance of  $s_2$ .

To construct the PDG for a program, we first find the data dependences between every pair of (not necessarily distinct) static accesses in every pair of (not necessarily distinct) statements. Suppose we determine that there is a dependence between access  $T_1$  in statement  $s_1$  and access  $T_2$  in statement  $s_2$ . Recall that an instance of a statement is specified by an index vector  $\mathbf{i} = [ih, \dots, im]$  where  $ik$  is the loop index of the  $k$ th outermost loop in which the statement is embedded.

1. If there exists a data-dependent pair of instances,  $\mathbf{i}_1$  of  $s_1$  and  $\mathbf{i}_2$  of  $s_2$ , and  $\mathbf{i}_1$  is executed before  $\mathbf{i}_2$  in the original program, written  $\mathbf{i}_1 \prec_{s_1, s_2} \mathbf{i}_2$ , then there is an edge from  $s_1$  to  $s_2$ .
2. Similarly, if there exists a data-dependent pair of instances,  $\mathbf{i}_1$  of  $s_2$  and  $\mathbf{i}_2$  of  $s_1$ , and  $\mathbf{i}_2 \prec_{s_1, s_2} \mathbf{i}_1$ , then there is an edge from  $s_2$  to  $s_1$ .

Note that it is possible for a data dependence between two statements  $s_1$  and  $s_2$  to generate both an edge from  $s_1$  to  $s_2$  and an edge from  $s_2$  back to  $s_1$ .

In the special case where statements  $s_1$  and  $s_2$  are not distinct,  $\mathbf{i}_1 \prec_{s_1, s_2} \mathbf{i}_2$  if and only if  $\mathbf{i}_1 \prec \mathbf{i}_2$  ( $\mathbf{i}_1$  is lexicographically less than  $\mathbf{i}_2$ ). In the general case,  $s_1$  and  $s_2$  may be different statements, possibly belonging to different loop nests.

**Example 11.51:** For the program of Example 11.50, there are no dependences among the instances of statement  $s_1$ . However, the  $z$ 'th instance of statement  $s_2$  must follow the  $z$ 'th instance of statement  $s_1$ . Worse, since the reference  $Wp4[i]$  may write any element of array  $W$ , the  $z$ 'th instance of  $s_2$  depends on all previous instances of  $s_2$ . That is, statement  $s_2$  depends on itself. The PDG for the program of Example 11.50 is shown in Fig. 11.40. Note that there is one cycle in the graph, containing  $s_2$  only. •

The program-dependence graph makes it easy to determine if we can split statements in a loop. Statements connected in a cycle in a PDG cannot be



Figure 11.40: Program-dependence graph for the program of Example 11.50

split. If  $s_i \rightarrow s_j$  is a dependence between two statements in a cycle, then some instance of  $s_i$  must execute before some instance of  $s_j$ , and vice versa. Note that this mutual dependence occurs only if  $s_i$  and  $s_j$  are embedded in some common loop. Because of the mutual dependence, we cannot execute all instances of one statement before the other, and therefore loop fission is not allowed. On the other hand, if the dependence  $s_i \rightarrow s_j$  is unidirectional, we can split up the loop and execute all the instances of  $s_i$  first, then those of  $s_j$ .

```

for (i = 0; i < n; i++) {
    Z[i] = Z[i] / WCi;          /* (s1) */
    for (j = i; j < n; j++) {
        X[i,j] = Y[i,j]*Y[i,j]; /* (s2) */
        Z[j] = Z[j] + X[i,j];   /* (s3) */
    }
}

```

(a) A program.

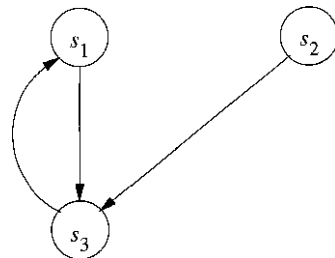

(b) Its dependence graph.

Figure 11.41: Program and dependence graph for Example 11.52.

Example 11.52: Figure 11.41(b) shows the program-dependence graph for the program of Fig. 11.41(a). Statements  $s_1$  and  $s_3$  belong to a cycle in the graph and therefore cannot be placed in separate loops. We can, however, split statement  $s_1$  out and execute all its instances before executing the rest of the computation, as in Fig. 11.42. The first loop is parallelizable, but the second is not. We can parallelize the first loop by placing barriers before and after its parallel execution. •

```

for (i = 0; i < n; i++)
  for (j = i; j < n; j++)
    X[i,j] = Y[i,j]*Y[i,j]; /* (s2) */
for (i = 0; i < n; i++) {
  Z[i] = Z[i] / W[i]; /* (si) */
  for (j = i; j < n; j++)
    Z[j] = Z[j] + X[i,j]; /* (s3) */
}

```

Figure 11.42: Grouping strongly connected components of a loop nest

### 11.8.3 Hierarchical Time

While the relation  $\prec_{s_{152}}$  can be very hard to compute in general, there is a family of programs to which the optimizations of this section are commonly applied, and for which there is a straightforward way to compute dependencies. Assume that the program is block structured, consisting of loops and simple arithmetic operations and no other control constructs. A statement in the program is either an assignment statement, a sequence of statements, or a loop construct whose body is a statement. The control structure thus represents a hierarchy. At the top of the hierarchy is the node representing the statement of the whole program. An assignment statement is a leaf node. If a statement is a sequence, then its children are the statements within the sequence, laid out from left to right according to their lexical order. If a statement is a loop, then its children are the components of the loop body, which is typically a sequence of one or more statements.

```

s0;
L1: for (i 0; ...) {
  si;
  L2: for (j 0; ) {
    s2;
    s3;
  }
  L3: for (k 0;
    s4;
  s5;
}

```

Figure 11.43: A hierarchically structured program

Example 11.53: The hierarchical structure of the program in Fig. 11.43 is shown in Fig. 11.44. The hierarchical nature of the execution sequence is high-



lighted in Fig. 11.45. The single instance of  $s_0$  precedes all other operations, because it is the first statement executed. Next, we execute all instructions from the first iteration of the outer loop before those in the second iteration and so forth. For all dynamic instances whose loop index  $i$  has value 0, the statements  $s_i$ ,  $L_2$ ,  $L_3$ , and  $s_5$  are executed in lexical order. We can repeat the same argument to generate the rest of the execution order. •

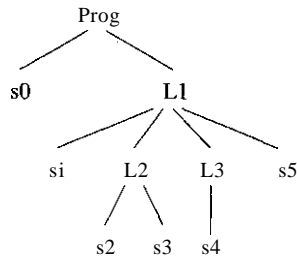

Figure 11.44: Hierarchical structure of the program in Example 11.53.

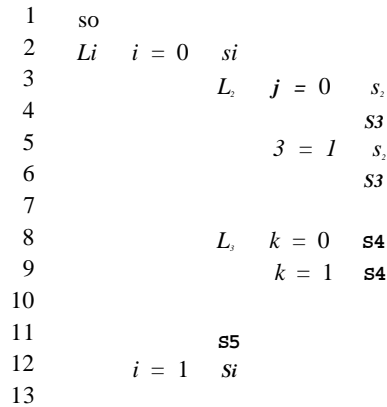

Figure 11.45: Execution order of the program in Example 11.53.

We can resolve the ordering of two instances from two different statements in a hierarchical manner. If the statements share common loops, we compare the values of their common loop indexes, starting with the outermost loop. As soon as we find a difference between their index values, the difference determines the ordering. Only if the index values for the outer loops are the same do we need to compare the indexes of the next inner loop. This process is analogous to how we would compare time expressed in terms of hours, minutes and seconds. To compare two times, we first compare the hours, and only if they refer to

the same hour would we compare the minutes and so forth. If the index values are the same for all common loops, then we resolve the order based on their relative lexical placement. Thus, the execution order for the simple nested-loop programs we have been discussing is often referred to as "hierarchical time."

Let  $s_i$  be a statement nested in a  $d_i$ -deep loop, and  $s_j$  in a  $d_j$ -deep loop, sharing  $d$  common (outer) loops; note  $d < d_i$  and  $d < d_j$  certainly. Suppose  $i = [i_1, \dots, i_d]$  is an instance of  $s_i$  and  $j = [j_1, \dots, j_d]$  is an instance of  $s_j$ .

$i$  precedes  $j$  and only if either

1.  $[i_1, \dots, i_d] \prec [j_1, \dots, j_d]$ , or
2.  $[i_1, \dots, i_d] = [j_1, \dots, j_d]$ , and  $s_i$  appears lexically before  $s_j$ .

The predicate  $[i_1, \dots, i_d] \prec [j_1, \dots, j_d]$  can be written as a disjunction of linear inequalities:

$$(\exists i < j_1) \vee (i_1 = j_1 \wedge \exists i_2 < j_2) \vee \dots \vee (i_1 = j_1 \wedge \dots \wedge i_{d-1} = j_{d-1} \wedge i_d < j_d)$$

A PDG edge from  $s_i$  to  $s_j$  exists as long as the data-dependence condition and one of the disjunctive clauses can be made true simultaneously. Thus, we may need to solve up to  $d$  or  $d + 1$  linear integer programs, depending on whether  $s_i$  appears lexically before  $s_j$ , to determine the existence of one edge.

### 11.8.4 The Parallelization Algorithm

We now present a simple algorithm that first splits up the computation into as many different loops as possible, then parallelizes them independently.

**Algorithm 11.54:** Maximize the degree of parallelism allowed by  $O(1)$  synchronizations.

**INPUT:** A program with array accesses.

**OUTPUT:** SPMD code with a constant number of synchronization barriers.

**METHOD:**

1. Construct the program-dependence graph and partition the statements into strongly connected components (SCC's). Recall from Section 10.5.8 that a strongly connected component is a maximal subgraph of the original whose every node in the subgraph can reach every other node.
2. Transform the code to execute SCC's in a topological order by applying fission if necessary.
3. Apply Algorithm 11.43 to each SCC to find all of its synchronization-free parallelism. Barriers are inserted before and after each parallelized SCC.

•

While Algorithm 11.54 finds all degrees of parallelism with  $O(1)$  synchronizations, it has a number of weaknesses. First, it may introduce unnecessary synchronizations. As a matter of fact, if we apply this algorithm to a program that can be parallelized without synchronization, the algorithm will parallelize each statement independently and introduce a synchronization barrier between the parallel loops executing each statement. Second, while there may only be a constant number of synchronizations, the parallelization scheme may transfer a lot of data among processors with each synchronization. In some cases, the cost of communication makes the parallelism too expensive, and we may even be better off executing the program sequentially on a uniprocessor. In the following sections, we shall next take up ways to increase data locality, and thus reduce the amount of communication.

### 11.8.5 Exercises for Section 11.8

**Exercise 11.8.1:** Apply Algorithm 11.54 to the code of Fig. 11.46.

```

for (i=0; i<100; i++)
    A[i] = A[i] + X[i]; /* (s1) */
for (i=0; i<100; i++)
    for (j=0; j<100; j++)
        B[i,j] = Y[i,j] + A[i] + A[j]; /* (s2) */

```

Figure 11.46: Code for Exercise 11.8.1

**Exercise 11.8.2:** Apply Algorithm 11.54 to the code of Fig. 11.47.

```

for (i=0; i<100; i++)
    A[i] = A[i] + X[i]; /* (s1) */
for (i=0; i<100; i++) {
    B[i] = B[i] + A[i]; /* (s2) */
    for (j=0; j<100; j++)
        C[j] = Y[j] + B[j]; /* (s3) */
}

```

Figure 11.47: Code for Exercise 11.8.2

**Exercise 11.8.3:** Apply Algorithm 11.54 to the code of Fig. 11.48.

```

for (i=0; i<100; i++)
  A[i] = A[i] + X[i]; /* (s1) */
for (i=0; i<100; i++) {
  for (j=0; j<100; j++)
    B[j] = A[i] + Y[j]; /* (s2) */
  C[i] = B[i] + Z[i]; /* (s3) */
  for (j=0; j<100; j++)
    D[i,j] = A[i] + B[j]; /* (s4) */
}

```

Figure 11.48: Code for Exercise 11.8.3

## 11.9 Pipelining

In pipelining, a task is decomposed into a number of stages to be performed on different processors. For example, a task computed using a loop of  $n$  iterations can be structured as a pipeline of  $n$  stages. Each stage is assigned to a different processor; when one processor is finished with its stage, the results are passed as input to the next processor in the pipeline.

In the following, we start by explaining the concept of pipelining in more detail. We then show a real-life numerical algorithm, known as successive over-relaxation, to illustrate the conditions under which pipelining can be applied, in Section 11.9.2. We then formally define the constraints that need to be solved in Section 11.9.6, and describe an algorithm for solving them in Section 11.9.7. Programs that have multiple independent solutions to the time-partition constraints are known as having outermost *fully permutable loops*; such loops can be pipelined easily, as discussed in Section 11.9.8.

### 11.9.1 What is Pipelining?

Our initial attempts to parallelize loops partitioned the iterations of a loop nest so that two iterations that shared data were assigned to the same processor. Pipelining allows processors to share data, but generally does so only in a "local," way, with data passed from one processor to another that is adjacent in the processor space. Here is a simple example.

**Example 11.55 :** Consider the loop:

```

for (i = 1; i <= m; i++)
  for (j = 1; j <= n; j++)
    X[i] = X[i] + Y[i,j];

```

This code sums up the  $i$ th row of  $Y$  and adds it to the  $i$ th element of  $X$ . The inner loop, corresponding to the summation, must be performed sequentially

Time	Processors		
	1	2	3
1	$x[i] += r[i, i]$		
2	$X[2] += Y[2, 1]$	$X[1] +: Y[1, 2]$	
3	$X[3] += Y[3, 1]$	$X[2] +: Y[2, 2]$	$X[1] +: Y[1, 3]$
4	$X[4] += Y[4, 1]$	$X[3] +: Y[3, 2]$	$X[2] +: Y[2, 3]$
5		$X[4] +: Y[4, 2]$	$X[3] +: Y[3, 3]$
6			$X[4] +: Y[4, 3]$

Figure 11.49: Pipelined execution of Example 11.55 with  $m = 4$  and  $n = 3$ .

because of the data dependence;<sup>6</sup> however, the different summation tasks are independent. We can parallelize this code by having each processor perform a separate summation. Processor  $i$  accesses row  $i$  of  $Y$  and updates the  $i$ th element of  $X$ .

Alternatively, we can structure the processors to execute the summation in a pipeline, and derive parallelism by overlapping the execution of the summations, as shown in Fig. 11.49. More specifically, each iteration of the inner loop can be treated as a stage of a pipeline: stage  $j$  takes an element of  $X$  generated in the previous stage, adds to it an element of  $Y$ , and passes the result to the next stage. Notice that in this case, each processor accesses a column, instead of a row, of  $Y$ . If  $Y$  is stored in column-major form, there is a gain in locality by partitioning according to columns, rather than by rows.

We can initiate a new task as soon as the first processor is done with the first stage of the previous task. At the beginning, the pipeline is empty and only the first processor is executing the first stage. After it completes, the results are passed to the second processor, while the first processor starts on the second task, and so on. In this way, the pipeline gradually fills until all the processors are busy. When the first processor finishes with the last task, the pipeline starts to drain, with more and more processors becoming idle until the last processor finishes the last task. In the steady state,  $n$  tasks can be executed concurrently in a pipeline of  $n$  processors. •

It is interesting to contrast pipelining with simple parallelism, where different processors execute different tasks:

- Pipelining can only be applied to nests of depth at least two. We can treat each iteration of the outer loop as a task and the iterations in the inner loop as stages of that task.
- Tasks executed on a pipeline may share dependences. Information pertaining to the same stage of each task is held on the same processor; thus results generated by the  $i$ th stage of a task can be used by the  $i$ th stage

<sup>6</sup>Remember that we do not take advantage of the assumed commutativity and associativity of addition.

of subsequent tasks with no communication cost. Similarly, each input data element used by a single stage of different tasks needs to reside only on one processor, as illustrated by Example 11.55.

- If the tasks are independent, then simple parallelization has better processor utilization because processors can execute all at once without having to pay for the overhead of filling and draining the pipeline. However, as shown in Example 11.55, the pattern of data accesses in a pipelined scheme is different from that of simple parallelization. Pipelining may be preferable if it reduces communication.

### 11.9.2 Successive Over-Relaxation (SOR): An Example

*Successive over-relaxation* (SOR) is a technique for accelerating the convergence of relaxation methods for solving sets of simultaneous linear equations. A relatively simple template illustrating its data-access pattern is shown in Fig. 11.50(a). Here, the new value of an element in the array depends on the values of elements in its neighborhood. Such an operation is performed repeatedly, until some convergence criterion is met.

```
for (i = 0; i <= m; i++)
  for (j = 0; j <= n; j++)
    X[j+1] = 1/3 * (X[j] + X[j+1] + XCj+2])
```

(a) Original source.

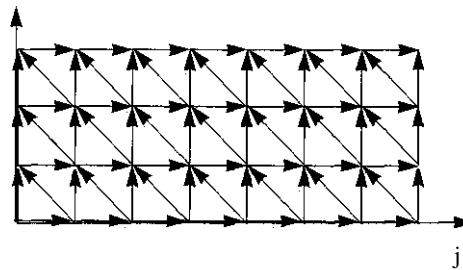

(b) Data dependences in the code.

Figure 11.50: An example of successive over-relaxation (SOR)

Shown in Fig. 11.50(b) is a picture of the key data dependences. We do not show dependences that can be inferred by the dependences already included in the figure. For example, iteration  $[i, j]$  depends on iterations  $[i, j - 1]$ ,  $[i, j - 2]$  and so on. It is clear from the dependences that there is no synchronization-free parallelism. Since the longest chain of dependences consists of  $O(m + n)$  edges, by introducing synchronization, we should be able to find one degree of parallelism and execute the  $O(mn)$  operations in  $O(m + n)$  unit time.

In particular, we observe that iterations that lie along the  $150^\circ$  diagonals<sup>7</sup> in Fig. 11.50(b) do not share any dependences. They **Only** depend on the iterations that lie along diagonals closer to the origin. Therefore we can parallelize this code by executing iterations on each diagonal in order, starting at the origin and proceeding outwards. We refer to the iterations along each diagonal as a *wavefront*, and such a parallelization scheme as *wavefronting*.

### 11.9.3 Fully Permutable Loops

We first introduce the notion of *full permutability*, a concept useful for pipelining and other optimizations. Loops are *fully permutable* if they can be permuted arbitrarily without changing the semantics of the original program. Once loops are put in a fully permutable form, we can easily pipeline the code and apply transformations such as blocking to improve data locality.

The SOR code, as it is written in Fig. 11.50(a), is not fully permutable. As shown in Section 11.7.8, permuting two loops means that iterations in the original iteration space are executed column by column instead of row by row. For instance, the original computation in iteration [2,3] would execute before that of [1,4], violating the dependences shown in Fig. 11.50(b).

We can, however, transform the code to make it fully permutable. Applying the affine transform

$$\begin{pmatrix} 1 & 0 \\ 1 & 1 \end{pmatrix}$$

to the code yields the code shown in Fig. 11.51(a). This transformed code is fully permutable, and its permuted version is shown in Fig. 11.51(c). We also show the iteration space and data dependences of these two programs in Fig. 11.51(b) and (d), respectively. From the figure, we can easily see that this ordering preserves the relative ordering between every data-dependent pair of accesses.

When we permute loops, we change the set of operations executed in each iteration of the outermost loop drastically. The fact that we have this degree of freedom in scheduling means that there is a lot of slack in the ordering of operations in the program. Slack in scheduling means opportunities for parallelization. We show later in this section that if a loop has  $k$  outermost fully permutable loops, by introducing just  $O(n)$  synchronizations, we can get  $O(k - 1)$  degrees of parallelism ( $n$  is the number of iterations in a loop).

### 11.9.4 Pipelining Fully Permutable Loops

A loop with  $k$  outermost fully permutable loops can be structured as a pipeline with  $O(k - 1)$  dimensions. In the SOR example,  $k = 2$ , so we can structure the processors as a linear pipeline.

<sup>7</sup>I.e., the sequences of points formed by repeatedly moving down 1 and right 2.

```

for (i = 0; i <= m; i++)
  for (j = i; j <= i+n; j++)
    X[j-i+1] = 1/3 * (X[j-i] + X[j-i+1] + X[j-i+2])
    
```

(a) The code in Fig. 11.50 transformed by  $\begin{bmatrix} 1 & 0 \\ 1 & 1 \end{bmatrix}$

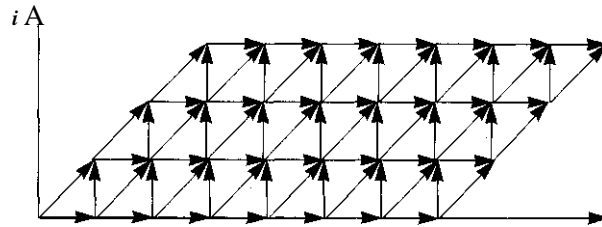

(b) Data dependences of the code in (a).

```

for (j = 0; j <= m+n; j++)
  for (i = max(0,j); i <= min(m,j), i++)
    X[j-i+1] = 1/3 * (X[j-i] + XCj-i+1] + X[j-i+2])
    
```

(c) A permutation of the loops in (a).

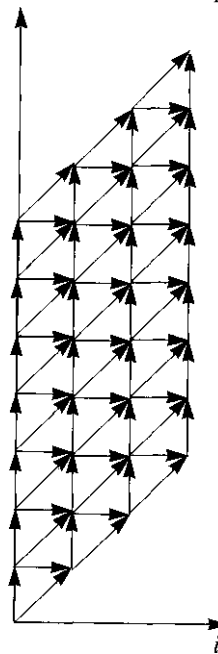

(d) Data dependences of the code in (b).

Figure 11.51: Fully permutable version of the code Fig. 11.50



We can pipeline the SOR code in two different ways, shown in Fig. 11.52(a) and Fig. 11.52(b), corresponding to the two possible permutations shown in Fig. 11.51(a) and (c), respectively. In each case, every column of the iteration space constitutes a task, and every row constitutes a stage. We assign stage  $i$  to processor  $i$ , thus each processor executes the inner loop of the code. Ignoring boundary conditions, a processor can execute iteration  $i$  only after processor  $p - 1$  has executed iteration  $i - 1$ .

```

/* 0 <= p <= m */
for (j = p; j <= p+n; j++) {
    if (p > 0) wait (p-1);
    X[j-p+1] = 1/3 * (X[j-p] + X[j-p+1] + X[j-p+2]);
    if (p < min (m,j)) signal (p+1);
}

```

(a) Processors assigned to rows.

```

/* 0 <= p <= m+n */
for (i = max(0,p); i <= min(m,p); i++) {
    if (p > max(0,i)) wait (p-1);
    X[p-i+1] = 1/3 * (X[p-i] + X[p-i+1] + X[p-i+2]);
    if (p < m+n) & (p > i) signal (p+1);
}

```

(b) Processors assigned to columns.

Figure 11.52: Two pipelining implementations of the code from Fig. 11.51

Suppose every processor takes exactly the same amount of time to execute an iteration and synchronization happens instantaneously. Both these pipelined schemes would execute the same iterations in parallel; the only difference is that they have different processor assignments. All the iterations executed in parallel lie along the  $135^\circ$  diagonals in the iteration space in Fig. 11.51(b), which corresponds to the  $150^\circ$  diagonals in the iteration space of the original code; see Fig. 11.50(b).

However, in practice, processors with caches do not always execute the same code in the same amount of time, and the time for synchronization also varies. Unlike the use of synchronization barriers which forces all processors to operate in lockstep, pipelining requires processors to synchronize and communicate with at most two other processors. Thus, pipelining has relaxed wavefronts, allowing some processors to surge ahead while others lag momentarily. This flexibility reduces the time processors spend waiting for other processors and improves parallel performance.

The two pipelining schemes shown above are but two of the many ways in which the computation can be pipelined. As we said, once a loop is fully

permutable, we have a lot of freedom in how we wish to parallelize the code. The first pipeline scheme maps iteration  $(i, j)$  to processor  $i$ ; the second maps iteration  $(i, j)$  to processor  $j$ . We can create alternative pipelines by mapping iteration  $(i, j)$  to processor  $CQI + cij$ , provided  $CQ$  and  $c$  are positive constants. Such a scheme would create pipelines with relaxed wavefronts between  $90^\circ$  and  $180^\circ$ , both exclusive.

### 11.9.5 General Theory

The example just completed illustrates the following general theory underlying pipelining: if we can come up with at least two different outermost loops for a loop nest and satisfy all the dependences, then we can pipeline the computation. A loop with  $k$  outermost fully permutable loops has  $k - 1$  degrees of pipelined parallelism.

Loops that cannot be pipelined do not have alternative outermost loops. Example 11.56 shows one such instance. To honor all the dependences, each iteration in the outermost loop must execute precisely the computation found in the original code. However, such code may still contain parallelism in the inner loops, which can be exploited by introducing at least  $n$  synchronizations, where  $n$  is the number of iterations in the outermost loop.

```

for (i = 0; i < 100; i++) {
    for (j = 0; j < 100; j++)
        x[j] = x[j] + y[i,j];    /* (s1) */
    z[i] = x[A[i]];              /* (s2) */
}

```

(a)

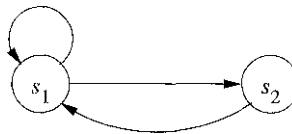

(b)

Figure 11.53: A sequential outer loop (a) and its PDG (b)

Example 11.56 : Figure 11.53 is a more complex version of the problem we saw in Example 11.50. As shown in the program dependence graph in Fig. 11.53(b), statements  $s_1$  and  $s_2$  belong to the same strongly connected component. Because we do not know the contents of matrix  $A$ , we must assume that the access in statement  $s_2$  may read from any of the elements of  $X$ . There is a true dependence from statement  $s_1$  to statement  $s_2$  and an antidependence from

statement  $s_2$  to statement  $s_1$ . There is no opportunity for pipelining either, because all operations belonging to iteration  $i$  in the outer loop must precede those in iteration  $i + 1$ . To find more parallelism, we repeat the parallelization process on the inner loop. The iterations in the second loop can be parallelized without synchronization. Thus, 200 barriers are needed, with one before and one after each execution of the inner loop. •

### 11.9.6 Time-Partition Constraints

We now focus on the problem of finding pipelined parallelism. Our goal is to turn a computation into a set of pipelinable tasks. To find pipelined parallelism, we do not solve directly for what is to be executed on each processor, like we did with loop parallelization. Instead, we ask the following fundamental question: What are all the possible execution sequences that honor the original data dependences in the loop? Obviously the original execution sequence satisfies all the data dependences. The question is if there are affine transformations that can create an alternative schedule, where iterations of the outermost loop execute a different set of operations from the original, and yet all the dependences are satisfied. If we can find such transforms, we can pipeline the loop. The key point is that if there is freedom in scheduling operations, there is parallelism; details of how we derive pipelined parallelism from such transforms will be explained later.

To find acceptable reorderings of the outer loop, we wish to find one-dimensional affine transforms, one for each statement, that map the original loop index values to an iteration number in the outermost loop. The transforms are legal if the assignment can satisfy all the data dependences in the program. The "time-partition constraints," shown below, simply say that if one operation is dependent upon the other, then the first must be assigned an iteration in the outermost loop no earlier than that of the second. If they are assigned in the same iteration, then it is understood that the first will be executed after than the second within the iteration.

An affine-partition mapping of a program is a *legal-time partition* if and only if for every two (not necessarily distinct) accesses sharing a dependence, say

$$•Fi = \langle Fi, fi, Bi, bi \rangle$$

in statement  $s_1$ , which is nested in  $d_1$  loops, and

$$T_2 = \langle F_2, f_2, B_2, b_2 \rangle$$

in statement  $s_2$  nested in  $d_2$  loops, the one-dimensional partition mappings  $(C_1, c_1)$  and  $(C_2, c_2)$  for statements  $s_1$  and  $s_2$ , respectively, satisfy the *time-partition constraints*:

- For all  $i_1$  in  $Z^{d_1}$  and  $i_2$  in  $Z^{d_2}$  such that

$$a) \quad i_1 \leq_{s_1} i_2 \quad b),$$

- b)  $B_{11}i_1 + b_1 > 0$ ,
- c)  $B_{21}i_1 + b_2 > 0$ , and
- d)  $F_{11}i_1 + f_1 = F_{21}i_1 + f_2$ ,

it is the case that  $C_{11}i_1 + c_1 < C_{21}i_1 + c_2$ .

This constraint, illustrated in Fig. 11.54, looks remarkably similar to the space-partition constraints. It is a relaxation of the space-partition constraints, in that if two iterations refer to the same location, they do not necessarily have to be mapped to the same partition; we only require that the original relative execution order between the two iterations is preserved. That is, the constraints here have  $<$  where the space-partition constraints have  $=$ .

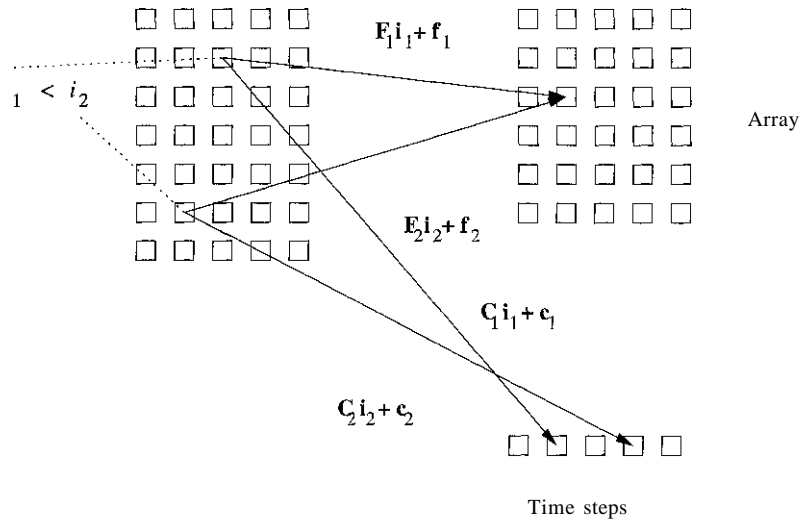

Figure 11.54: Time-Partition Constraints

We know that there exists at least one solution to the time-partition constraints. We can map operations in each iteration of the outermost loop back to the same iteration, and all the data dependences will be satisfied. This solution is the only solution to the time-partition constraints for programs that cannot be pipelined. On the other hand, if we can find several independent solutions to time-partition constraints, the program can be pipelined. Each independent solution corresponds to a loop in the outermost fully permutable nest. As you can expect, there is only one independent solution to the timing constraints extracted from the program in Example 11.56, where there is no pipelined parallelism, and that there are two independent solutions to the SOR code example.

Example 11.57: Let us consider Example 11.56, and in particular the data dependences of references to array  $X$  in statements  $s_1$  and  $s_2$ . Because the

access is not affine in statement  $s_1$ , we approximate the access by modeling matrix  $X$  simply as a scalar variable in dependence analysis involving statement  $s_1$ . Let  $i$  be the index value of a dynamic instance of  $s_1$  and let  $i'$  be the index value of a dynamic instance of  $s_2$ . Let the computation mappings of statements  $s_1$  and  $s_2$  be  $([C_1, C_1], c_1)$  and  $([C_2], c_2)$ , respectively.

Let us first consider the time-partition constraints imposed by dependences from statement  $s_1$  to  $s_2$ . Thus,  $i < i'$ , the transformed  $(i, j)$ th iteration of  $s_1$  must be no later than the transformed  $i'$ th iteration of  $s_2$ ; that is,

$$C_1 i - C_2 i' + c_1 < C_2 i' + c_2.$$

Expanding, we get

$$C_1 i + C_2 j + c_1 < C_2 i' + c_2.$$

Since  $j$  can be arbitrarily large, independent of  $i$  and  $i'$ , it must be that  $C_2 = 0$ . Thus, one possible solution to the constraints is

$$C_1 = C_2 = 1 \quad \text{and} \quad C_3 = c_1 = c_2 = 0.$$

Similar arguments about the data dependence from  $s_2$  to  $s_1$  and  $s_2$  back to itself will yield a similar answer. In this particular solution, the  $i$ th iteration of the outer loop, which consists of the instance  $i$  of  $s_2$  and all instances of  $s_1$ , are all assigned to timestep  $i$ . Other legal choices of  $C_1$ ,  $C_2$ ,  $c_1$ , and  $c_2$  yield similar assignments, although there might be timesteps at which nothing happens. That is, all ways to schedule the outer loop require the iterations to execute in the same order as in the original code. This statement holds whether all 100 iterations are executed on the same processor, on 100 different processors, or anything in between. •

Example 11.58: In the SOR code shown in Fig. 11.50(a), the write reference  $X[j + 1]$  shares a dependence with itself and with the three read references in the code. We are seeking computation mapping  $([C_1, C_2], c)$  for the assignment statement such that

$$[C_1 i - C_2 i' + c] < [d - C_2 j] + [c]$$

if there is a dependence from  $s_1$  to  $s_2$ . By definition,  $X$  that is, either  $i < i'$  or  $(i = i' \wedge j < j')$ .

Let us consider three of the pairs of data dependences:

1. True dependence from write access  $X[j + 1]$  to read access  $X[j + 2]$ . Since the instances must access the same location,  $j + 1 = j' + 2$  or  $j = j' + 1$ . Substituting  $j = j' + 1$  into the timing constraints, we get

$$d - i - C_2 > 0.$$

Since  $j = j' + 1, j > j'$ , the precedence constraints reduce to  $i < i'$ . Therefore,

$$C_i - C_2 > 0.$$

2. Antidependence from read access  $X[j + 2]$  to write access  $X[j + 1]$ . Here,  $j + 2 = j' + 1$ , or  $j = j' - 1$ . Substituting  $j = j' - 1$  into the timing constraints, we get

$$C_i(i' - i) + C_2 > 0.$$

When  $i = i'$ , we get

$$C_2 > 0.$$

When  $i < i'$ , since  $C_2 > 0$ , we get

$$d > 0.$$

3. Output dependence from write access  $X[j + 1]$  back to itself. Here  $j = j'$ . The timing constraints reduce to

$$C_i(i' - i) > 0.$$

Since only  $i < i'$  is relevant, we again get

$$C_i > 0.$$

The rest of the dependences do not yield any new constraints. In total, there are three constraints:

$$\begin{aligned} C_i &> 0 \\ C_2 &> 0 \\ C_i - C_2 &> 0 \end{aligned}$$

Here are two independent solutions to these constraints:

$$\begin{bmatrix} 1 \\ 0 \end{bmatrix}, \begin{bmatrix} 1 \\ 1 \end{bmatrix}$$

The first solution preserves the execution order of the iterations in the outermost loop. Both the original SOR code in Fig. 11.50(a) and the transformed code shown in Fig. 11.51(a) are examples of such an arrangement. The second solution places iterations lying along the 135° diagonals in the same outer loop. The code shown in Fig. 11.51(b) is an example of a code with that outermost loop composition.

Notice that there are many other possible pairs of independent solutions. For example,

$$\begin{bmatrix} 1 \\ 1 \end{bmatrix}, \begin{bmatrix} 2 \\ 1 \end{bmatrix}$$

would also be an independent solutions to the same constraints. We choose the simplest vectors to simplify code transformation. •

### 11.9.7 Solving Time-Partition Constraints by Farkas' Lemma

Since time-partition constraints are similar to space-partition constraints, can we use a similar algorithm to solve them? Unfortunately, the slight difference between the two problems translates into a big technical difference between the two solution methods. Algorithm 11.43 simply solves for  $C_i, c_i, C_i,$  and  $c_i,$  such that for all  $i$  in  $Z^n$  and  $i_i$  in  $Z^n$  if

$$F_i i_i + f_i = F_i i_i + f_i$$

then

$$C_i i_i - c_i = C_i i_i - c_i.$$

The linear inequalities due to the loop bounds are only used in determining if two references share a data dependence, and are not used otherwise.

To find solutions to the time-partition constraints, we cannot ignore the linear inequalities  $i_i < i_i'$ ; ignoring them often would allow only the trivial solution of placing all iterations in the same partition. Thus, the algorithm to find solutions to the time-partition constraints must handle both equalities and inequalities.

The general problem we wish to solve is: given a matrix  $A$ , find a vector  $c$  such that for all vectors  $x$  such that  $Ax > 0$ , it is the case that  $c^T x > 0$ . In other words, we are seeking  $c$  such that the inner product of  $c$  and any coordinates in the polyhedron defined by the inequalities  $Ax > 0$  always yields a nonnegative answer.

This problem is addressed by *Farkas' Lemma*. Let  $A$  be an  $m \times n$  matrix of reals, and let  $c$  be a real, nonzero  $n$ -vector. Farkas' lemma says that either the *primal* system of inequalities

$$Ax > 0, \quad c^T x < 0$$

has a real-valued solution  $x$ , or the *dual* system

$$A^T y = c, \quad y > 0$$

has a real-valued solution  $y$ , but never both.

The dual system can be handled by using Fourier-Motzkin elimination to project away the variables of  $y$ . For each  $c$  that has a solution in the dual system, the lemma guarantees that there are no solutions to the primal system. Put another way, we can prove the negation of the primal system, i.e., we can prove that  $c^T x > 0$  for all  $x$  such that  $Ax > 0$ , by finding a solution  $y$  to the dual system:  $A^T y = c$  and  $y > 0$ .

**Algorithm 11.59:** Finding a set of legal, maximally independent affine time-partition mappings for an outer sequential loop.

### About Farkas' Lemma

The proof of the lemma can be found in many standard texts on linear programming. Farkas' Lemma, originally proved in 1901, is one of the *theorems of the alternative*. These theorems are all equivalent but, despite attempts over the years, a simple, intuitive proof for this lemma or any of its equivalents has not been found.

**INPUT:** A loop nest with array accesses.

**OUTPUT:** A maximal set of linearly independent time-partition mappings.

**METHOD:** The following steps constitute the algorithm:

1. Find all data-dependent pairs of accesses in a program.
2. For each pair of data-dependent accesses,  $T_1 = (\mathbf{F}_1, \mathbf{f}_1, \mathbf{B}_1, \mathbf{b}_1)$  in statement  $s_1$  nested in  $d_1$  loops and  $T_2 = (\mathbf{F}_2, \mathbf{f}_2, \mathbf{B}_2, \mathbf{b}_2)$  in statement  $s_2$  nested in  $d_2$  loops, let  $(\mathbf{C}_1, \mathbf{c}_1)$  and  $(\mathbf{C}_2, \mathbf{c}_2)$  be the (unknown) time-partition mappings of statements  $s_1$  and  $s_2$ , respectively. Recall the time-partition constraints state that

- For all  $\mathbf{i}_1$  in  $\mathbf{Z}^n$  and  $\mathbf{i}_2$  in  $\mathbf{Z}^n$  such that

$$\text{a) } \mathbf{i}_1 \leq \mathbf{g}_{1s_2} \mathbf{h},$$

$$\text{b) } \mathbf{B}_1 \mathbf{i}_1 + \mathbf{b}_1 > 0,$$

$$\text{c) } \mathbf{B}_2 \mathbf{i}_2 + \mathbf{b}_2 > 0, \text{ and}$$

$$\text{d) } \mathbf{F}_1 \mathbf{i}_1 + \mathbf{f}_1 = \mathbf{F}_2 \mathbf{i}_2 + \mathbf{f}_2,$$

it is the case that  $\mathbf{C}_1 \mathbf{i}_1 + \mathbf{c}_1 < \mathbf{C}_2 \mathbf{i}_2 + \mathbf{c}_2$ .

Since  $\mathbf{i}_1 \leq \mathbf{g}_{1s_2} \mathbf{h}$  is a disjunctive union of a number of clauses, we can create a system of constraints for each clause and solve each of them separately, as follows:

- (a) Similarly to step (2a) in Algorithm 11.43, apply Gaussian elimination to the equations

$$\mathbf{F}_1 \mathbf{i}_1 + \mathbf{f}_1 = \mathbf{F}_2 \mathbf{i}_2 + \mathbf{f}_2$$

to reduce the vector

$$\begin{matrix} \mathbf{i}_1 \\ \mathbf{h} \\ \mathbf{1} \end{matrix}$$

to some vector of unknowns,  $\mathbf{x}$ .



- (b) Let  $\mathbf{c}$  be all the unknowns in the partition mappings. Express the linear inequality constraints due to the partition mappings as

$$\mathbf{c}^T \mathbf{D} \mathbf{x} > \mathbf{0}$$

for some matrix  $\mathbf{D}$ .

- (c) Express the precedence constraints on the loop index variables and the loop bounds as

$$\mathbf{A} \mathbf{x} > \mathbf{0}$$

for some matrix  $\mathbf{A}$ .

- (d) Apply Farkas' Lemma. Finding  $\mathbf{x}$  to satisfy the two constraints above is equivalent to finding  $\mathbf{y}$  such that

$$\mathbf{A}^T \mathbf{y} = \mathbf{D}^T \mathbf{c} \text{ and } \mathbf{y} > \mathbf{0}.$$

Note that  $\mathbf{c}^T \mathbf{D}$  here is  $\mathbf{c}^T$  in the statement of Farkas' Lemma, and we are using the negated form of the lemma.

- (e) In this form, apply Fourier-Motzkin elimination to project away the  $\mathbf{y}$  variables, and express the constraints on the coefficients  $\mathbf{c}$  as  $\mathbf{E} \mathbf{c} > \mathbf{0}$ .
- (f) Let  $\mathbf{E}' \mathbf{c}' > \mathbf{0}$  be the system without the constant terms.
3. Find a maximal set of linearly independent solutions to  $\mathbf{E}' \mathbf{c}' > \mathbf{0}$  using Algorithm B.I in Appendix B. The approach of that complex algorithm is to keep track of the current set of solutions for each of the statements, then incrementally look for more independent solutions by inserting constraints that force the solution to be linearly independent for at least one statement.
4. From each solution of  $\mathbf{c}'$  found, derive one affine time-partition mapping. The constant terms are derived using  $\mathbf{E} \mathbf{c} > \mathbf{0}$ .

•

**Example 11.60:** The constraints for Example 11.57 can be written as

$$\begin{bmatrix} -C_1 & -C_1 i_1 & C_1 i_1 & (c_1 - c_1 i_1) \end{bmatrix} > \mathbf{0}$$

$$\begin{bmatrix} -1 & 0 & 1 & 0 \end{bmatrix} > \mathbf{0}$$

Farkas' lemma says that these constraints are equivalent to

$$\begin{bmatrix} 1 & -1 \\ 0 \\ 1 \\ 0 \end{bmatrix} [*] = \begin{bmatrix} -Cn \\ -C2 \\ C2l \\ c_2 - ci \end{bmatrix}$$

Solving this system, we get

$$Cn = C2l > 0 \text{ and } C2 = c_2 - ci = 0.$$

Notice that these constraints are satisfied by the particular solution we obtained in Example 11.57. •

### 11.9.8 Code Transformations

If there exist  $k$  independent solutions to the time-partition constraints of a loop nest, then it is possible to transform the loop nest to have  $k$  outermost fully permutable loops, which can be transformed to create  $k-1$  degrees of pipelining, or to create  $k-1$  inner parallelizable loops. Furthermore, we can apply blocking to fully permutable loops to improve data locality of uniprocessors as well as reducing synchronization among processors in a parallel execution.

#### Exploiting Fully Permutable Loops

We can create a loop nest with  $k$  outermost fully permutable loops easily from  $k$  independent solutions to the time-partition constraints. We can do so by simply making the  $k$ th. solution the  $k$ th row of the new transform. Once the affine transform is created, Algorithm 11.45 can be used to generate the code.

**Example 11.61:** The solutions found in Example 11.58 for our SOR example were

$$\begin{bmatrix} 1 \\ 0 \end{bmatrix} \quad \begin{bmatrix} 1 \\ 1 \end{bmatrix}$$

Making the first solution the first row and the second solution the second row, we get the transform

$$\begin{bmatrix} 1 & 0 \\ 1 & 1 \end{bmatrix}$$

which yields the code in Fig. 11.51(a).

Making the second solution the first row instead, we get the transform

$$\begin{bmatrix} 1 & 1 \\ 1 & 0 \end{bmatrix}$$

which yields the code in Fig. 11.51(c). •

It is easy to see that such transforms produce a legal sequential program. The first row partitions the entire iteration space according to the first solution. The timing constraints guarantee that such a decomposition does not violate any data dependences. Then, we partition the iterations in each of the outermost loop according to the second solution. Again this must be legal because we are dealing with just subsets of the original iteration space. The same goes for the rest of the rows in the matrix. Since we can order the solutions arbitrarily, the loops are fully permutable.

**Exploiting Pipelining**

We can easily transform a loop with  $k$  outermost fully permutable loops into a code with  $k - 1$  degrees of pipeline parallelism.

**Example 11.62:** Let us return to our SOR example. After the loops are transformed to be fully permutable, we know that iteration  $[k, i, j]$  can be executed provided iterations  $[k, k - 1]$  and  $[k - 1, j]$  have been executed. We can guarantee this order in a pipeline as follows. We assign iteration  $k$  to processor  $p_i$ . Each processor executes iterations in the inner loop in the original sequential order, thus guaranteeing that iteration  $[k, i, j]$  executes after  $[i, i, j - 1]$ . In addition, we require that processor  $p$  waits for the signal from processor  $p - 1$  that it has executed iteration  $[p - 1, i, j]$  before it executes iteration  $[p, i, j]$ . This technique generates the pipelined code Fig. 11.52(a) and (b) from the fully permutable loops Fig. 11.51(a) and (c), respectively. •

In general, given  $k$  outermost fully permutable loops, the iteration with index values  $(i_1, \dots, i_k)$  can be executed without violating data-dependence constraints, provided iterations

$$[k - 1, i_1, \dots, i_k] \text{ and } [k - 2, i_1, \dots, i_k], \dots, [k, i_1, \dots, i_k - 1]$$

have been executed. We can thus assign the partitions of the first  $k - 1$  dimensions of the iteration space to  $0(n^{k-1})$  processors as follows. Each processor is responsible for one set of iterations whose indexes agree in the first  $k - 1$  dimensions, and vary over all values of the  $k$ th index. Each processor executes the iterations in the  $k$ th loop sequentially. The processor corresponding to values  $[p_1, p_2, \dots, p_{k-1}]$  for the first  $k - 1$  loop indexes can execute iteration  $i$  in the  $k$ th loop as long as it receives a signal from processors

$$[p_1 - 1, p_2, \dots, p_{k-1}], \dots, [p_1, p_2 - 1, p_3, \dots, p_{k-1} - 1]$$

that they have executed their  $i$ th iteration in the  $k$ th loop.

**Wavefronting**

It is also easy to generate  $k - 1$  inner parallelizable loops from a loop with  $k$  outermost fully permutable loops. Although pipelining is preferable, we include this information here for completeness.

We partition the computation of a loop with  $k$  outermost fully permutable loops using a new index variable  $i'$  where  $i'$  is defined to be some combination of all the indices in the  $k$  permutable loop nest. For example,  $i' = i_1 \pm \dots \pm i_k$  is one such combination.

We create an outermost sequential loop that iterates through the  $i'$  partitions in increasing order; the computation nested within each partition is ordered as before. The first  $k - 1$  loops within each partition are guaranteed to be parallelizable. Intuitively, if given a two-dimensional iteration space, this transform groups iterations along  $135^\circ$  diagonals as an execution of the outermost loop. This strategy guarantees that iterations within each iteration of the outermost loop have no data dependence.

### Blocking

A  $k$ -deep, fully permutable loop nest can be blocked in  $\wedge$ -dimensions. Instead of assigning the iterations to processors based on the value of the outer or inner loop indexes, we can aggregate blocks of iterations into one unit. Blocking is useful for enhancing data locality as well as for minimizing the overhead of pipelining.

Suppose we have a two-dimensional fully permutable loop nest, as in Fig. 11.55(a), and we wish to break the computation into  $b \times b$  blocks. The execution order of the blocked code is shown in Fig. 11.56, and the equivalent code is in Fig. 11.55(b).

If we assign each block to one processor, then all the passing of data from one iteration to another that is within a block requires no interprocessor communication. Alternatively, we can coarsen the granularity of pipelining by assigning a column of blocks to one processor. Notice that each processor synchronizes with its predecessors and successors only at block boundaries. Thus, another advantage of blocking is that programs only need to communicate data accessed at the boundaries of the block with their neighbor blocks. Values that are interior to a block are managed by only one processor.

**Example 11.63:** We now use a real numerical algorithm — Cholesky decomposition — to illustrate how Algorithm 11.59 handles single loop nests with only pipelining parallelism. The code, shown in Fig. 11.57, implements an  $O(n^3)$  algorithm, operating on a 2-dimensional data array. The executed iteration space is a triangular pyramid, since  $j$  only iterates up to the value of the outer loop index  $i$ , and  $k$  only iterates to the value of  $j$ . The loop has four statements, all nested in different loops.

Applying Algorithm 11.59 to this program finds three legitimate time dimensions. It nests all the operations, some of which were originally nested in 1- and 2-deep loop nests into a 3-dimensional, fully permutable loop nest. The code, together with the mappings, is shown in Fig. 11.58.

The code-generation routine guards the execution of the operations with the original loop bounds to ensure that the new programs execute only operations

```

for (i=0; i<n; i++)
  for (j=1; j<n; j++) {
    <S>
  }

```

(a) A simple loop nest.

```

for (ii = 0; ii<n; ii+=b)
  for (jj = 0; jj<n; jj+=b)
    for (i = ii*b; i <= min(ii*b-1, n); i++)
      for (j = ii*b; j <= min(jj*b-1, n); j++) {
        <S>
      }

```

(b) A blocked version of this loop nest.

Figure 11.55: A 2-dimensional loop nest and its blocked version

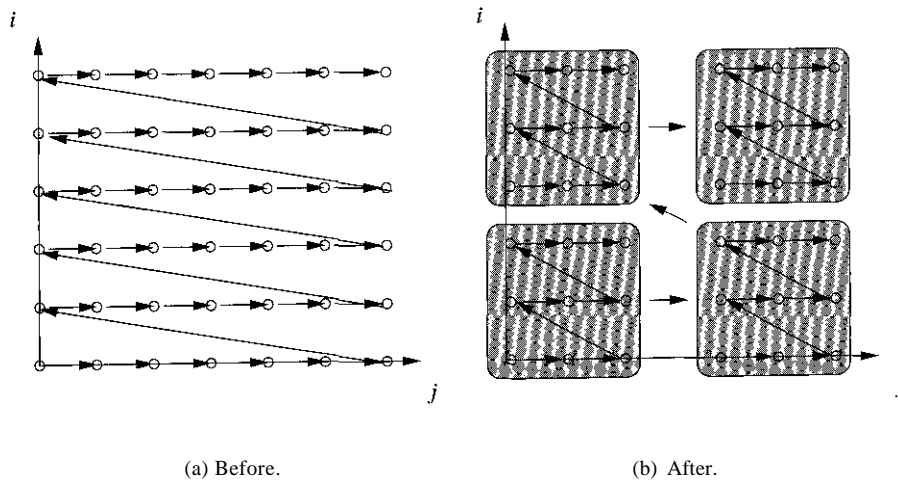

Figure 11.56: Execution order before and after blocking a 2-deep loop nest.

9. PIPELINING

```
for (i = 1; i <= N; i++) {
  for (j = 1; j <= i-1; j++) {
    for (k = 1; k <= j-1; k++)
      X[i,j] = X[i,j] - X[i,k] * X[j,k];
    X[i,j] = X[i,j] / X[j,j];
  }
  for (m = 1; m <= i-1; m++)
    X[i,i] = X[i,i] - X[i,m] * X[i,m];
  X[i,i] = sqrt(X[i,i]);
}
```

Figure 11.57: Cholesky decomposition

```
for (i2 = 1; i2 <= N; i2++)
  for (j2 = 1; j2 <= i2; j2++) {
    /* beginning of code for processor (i2,j2) */
    for (k2 = 1; k2 <= i2; k2++) {

      // Mapping: i2 = i, j2 = j, k2 = k
      if (j2 < i2 kk k2 < j2)
        X[i2,j2] = X[i2,j2] - X[i2,k2] * X[j2,k2];

      // Mapping: i2 = i, j2 = j, k2 = j
      if (j2 == k2 kk j2 < i2)
        X[i2,j2] = X[i2,j2] / X[j2,j2];

      // Mapping: i2 = i, j2 = i, k2 = m
      if (i2 == j2 kk k2 < i2)
        X[i2,i2] = X[i2,i2] - X[i2,k2] * X[i2,k2];

      // Mapping: i2 = i, j2 = i, k2 = i
      if (i2 == j2 kk j2 == k2)
        X[k2,k2] = sqrt(X[k2,k2]);
    }
    /* ending of code for processor (i2,j2) */
  }
```

Figure 11.58: Figure 11.57 written as a fully permutable loop nest

that are in the original code. We can pipeline this code by mapping the 3-dimensional structure to a 2-dimensional processor space. Iterations  $(i2, j2, k2)$  are assigned to the processor with ID  $(i2, j2)$ . Each processor executes the innermost loop, the loop with the index  $k2$ . Before it executes the  $k$ th iteration, the processor waits for signals from the processors with ID's  $(i2 - 1, j2)$  and  $(i2, j2 - 1)$ . After it executes its iteration, it signals processors  $(i2 + 1, j2)$  and  $(i2, j2 + 1)$ . •

### 11.9.9 Parallelism With Minimum Synchronization

We have described three powerful parallelization algorithms in the last three sections: Algorithm 11.43 finds all parallelism requiring no synchronizations, Algorithm 11.54 finds all parallelism requiring only a constant number of synchronizations, and Algorithm 11.59 finds all the pipelinable parallelism requiring  $O(n)$  synchronizations where  $n$  is the number of iterations in the outermost loop. As a first approximation, our goal is to parallelize as much of the computation as possible, while introducing as little synchronization as necessary.

Algorithm 11.64, below, finds all the degrees of parallelism in a program, starting with the coarsest granularity of parallelism. In practice, to parallelize a code for a multiprocessor, we do not need to exploit all the levels of parallelism, just the outermost possible ones until all the computation is parallelized and all the processors are fully utilized.

Algorithm 11.64: Find all the degrees of parallelism in a program, with all the parallelism being as coarse-grained as possible.

**INPUT:** A program to be parallelized.

**OUTPUT:** A parallelized version of the same program.

**METHOD:** Do the following:

1. Find the maximum degree of parallelism requiring no synchronization: Apply Algorithm 11.43 to the program.
2. Find the maximum degree of parallelism that requires  $O(1)$  synchronizations: Apply Algorithm 11.54 to each of the space partitions found in step 1. (If no synchronization-free parallelism is found, the whole computation is left in one partition).
3. Find the maximum degree of parallelism that requires  $O(n)$  synchronizations. Apply Algorithm 11.59 to each of the partitions found in step 2 to find pipelined parallelism. Then apply Algorithm 11.54 to each of the partitions assigned to each processor, or the body of the sequential loop if no pipelining is found.
4. Find the maximum degree of parallelism with successively greater degrees of synchronizations: Recursively apply Step 3 to computation belonging to each of the space partitions generated by the previous step.

•

**Example 11.65:** Let us now return to Example 11.56. No parallelism is found by Steps 1 and 2 of Algorithm 11.54; that is, we need more than a constant number of synchronizations to parallelize this code. In Step 3, applying Algorithm 11.59 determines that there is only one legal outer loop, which is the one in the original code of Fig. 11.53. So, the loop has no pipelined parallelism. In the second part of Step 3, we apply Algorithm 11.54 to parallelize the inner loop. We treat the code within a partition like a whole program, the only difference being that the partition number is treated like a symbolic constant. In this case the inner loop is found to be parallelizable and therefore the code can be parallelized with  $n$  synchronization barriers. •

Algorithm 11.64 finds all the parallelism in a program at each level of synchronization. The algorithm prefers parallelization schemes that have less synchronization, but less synchronization does not mean that the communication is minimized. Here we discuss two extensions to the algorithm to address its weaknesses.

### Considering Communication Cost

Step 2 of Algorithm 11.64 parallelizes each strongly connected component independently if no synchronization-free parallelism is found. However, it may be possible to parallelize a number of the components without synchronization and communication. One solution is to greedily find synchronization-free parallelism among subsets of the program dependence graph that share the most data.

If communication is necessary between strongly connected components, we note that some communication is more expensive than others. For example, the cost of transposing a matrix is significantly higher than just having to communicate between neighboring processors. Suppose  $s_i$  and  $s_j$  are statements in two separate strongly connected components accessing the same data in iterations  $i_i$  and  $i_j$ , respectively. If we cannot find partition mappings  $(C_i, c_i)$  and  $(C_j, c_j)$  for statements  $s_i$  and  $s_j$ , respectively, such that

$$C_i i_i + c_i - C_j i_j + c_j = 0,$$

we instead try to satisfy the constraint

$$C_i i_i + c_i - C_j i_j + c_j < S$$

where  $S$  is a small constant.

### Trading Communication for Synchronization

Sometimes we would rather perform more synchronizations to minimize communication. Example 11.66 discusses one such example. Thus, if we cannot



parallelize a code with just neighborhood communication among strongly connected components, we should attempt to pipeline the computation instead of parallelizing each component independently. As shown in Example 11.66, pipelining can be applied to a sequence of loops.

**Example 11.66:** For the ADI integration algorithm in Example 11.49, we have shown that optimizing the first and second loop nests independently finds parallelism in each of the nests. However, such a scheme would require that the matrix be transposed between the loops, incurring  $O(n^2)$  data traffic. If we use Algorithm 11.59 to find pipelined parallelism, we find that we can turn the entire program into a fully permutable loop nest, as in Fig. 11.59. We then can apply blocking to reduce the communication overhead. This scheme would incur  $O(n)$  synchronizations but would require much less communication. •

```

for (j = 0; j < n; j++)
  for (i = 1; i < n+1; i++) {
    if (i < n) x[i,j] = f(x[i,j] + x[i-1,j])
    if (j > 0) x[i-1,j] = g(x[i-1,j], x[i-1,j-1]);
  }

```

Figure 11.59: A fully permutable loop nest for the code of Example 11.49

### 11.9.10 Exercises for Section 11.9

**Exercise 11.9.1:** In Section 11.9.4, we discussed the possibility of using diagonals other than the horizontal and vertical axes to pipeline the code of Fig. 11.51. Write code analogous to the loops of Fig. 11.52 for the diagonals: (a)  $135^\circ$  (b)  $120^\circ$ .

**Exercise 11.9.2:** Figure 11.55(b) can be simplified if  $b$  divides  $n$  evenly. Rewrite the code under that assumption.

```

for (i=0; i<100; i++) {
  P[i,0] = 1; /* s1 */
  P[i,i] = 1; /* s2 */
}
for (i=2; i<100; i++)
  for (j=1; j<i; j++)
    P[i,j] = P[i-1,j-1] + P[i-1,j]; /* s3 */

```

Figure 11.60: Computing Pascal's triangle

**Exercise 11.9.3:** In Fig. 11.60 is a program to compute the first 100 rows of Pascal's triangle. That is,  $P[i,j]$  will become the number of ways to choose  $j$  things out of  $i$ , for  $0 < j < i < 100$ .

- Rewrite the code as a single, fully permutable loop nest.
- Use 100 processors in a pipeline to implement this code. Write the code for each processor  $p$ , in terms of  $p$ , and indicate the synchronization necessary.
- Rewrite the code using square blocks of 10 iterations on a side. Since the iterations form a triangle, there will be only  $1 + 2 + \dots + 10 = 55$  blocks. Show the code for a processor ( $p_i, P_2$ ) assigned to the  $p_i$ th block in the  $i$  direction and the  $p_2$ th block in the  $j$  direction, in terms of  $p_i$  and  $p_2$ .

```

for (i=0; i<100; i++) {
    A[i, 0,0] = B1[i]; /* s1 */
    A[i,99,0] = B2[i]; /* s2 */
}
for (j=1; j<99; j++) {
    A[ 0,j,0] = B3[j]; /* s3 */
    AC99,j,0] = B4[j]; /* s4 */
}
for (i=0; i<99; i++)
    for (j=0; j<99; j++)
        for (k=1; k<100; k++)
            ACi,j,k] = (4*A[i,j,k-1] + ACi-1,j,k-1] +
                ACi+1,j,k-1] + ACi,j-1,k-1] +
                A[i,j+1,k-1]); /* s5 */

```

Figure 11.61: Code for Exercise 11.9.4

**! Exercise 11.9.4:** Repeat Exercise 11.9.2 for the code of Fig. 11.61. However, note that the iterations for this problem form a 3-dimensional cube of side 100. Thus, the blocks for part (c) should be  $10 \times 10 \times 10$ , and there are 1000 of them.

**! Exercise 11.9.5:** Let us apply Algorithm 11.59 to a simple example of the time-partition constraints. In what follows, assume that the vector  $ii$  is and vector  $ji$  is  $(i_2, j_2)$ ; technically, both these vectors are transposed. The condition  $ii \prec_{s_2} ji$  consists of the following disjunction:

*i.*  $i_1 < j_1$ , or

*ii.*  $i_1 = j_1$  and  $i_2 < j_2$ .

The other equalities and inequalities are

$$\begin{aligned}
2n + j_i - 10 &> 0 \\
i_i + 2j_i - 20 &> 0 \\
h &= h + h \sim 50 \\
h &= h + 40
\end{aligned}$$

Finally, the time-partition inequality, with unknowns  $c_i$ ,  $d_i$ ,  $e_i$ ,  $c_j$ ,  $d_j$ , and  $e_j$ , is

$$c_i h + d_i j_i + e_i < c_j i_j + d_j j_j + e_j.$$

- a) Solve the time-partition constraints for case  $i$  — that is, where  $i_i < i_j$ . In particular, eliminate as many of  $i_i$ ,  $j_i$ ,  $i_j$ , and  $j_j$  as you can, and set up the matrices  $D$  and  $A$  as in Algorithm 11.59. Then, apply Farkas' Lemma to the resulting matrix inequalities.
- b) Repeat part (a) for the case  $ii$ , where  $i_i = i_j$  and  $j_i < j_j$ .

## 11.10 Locality Optimizations

The performance of a processor, be it a part of a multiprocessor or not, is highly sensitive to its cache behavior. Misses in the cache can take tens of clock cycles, so high cache-miss rates can lead to poor processor performance. In the context of a multiprocessor with a common memory bus, contention on the bus can further add to the penalty of poor data locality.

As we shall see, even if we just wish to improve the locality of uniprocessors, the affine-partitioning algorithm for parallelization is useful as a means of identifying opportunities for loop transformations. In this section, we describe three techniques for improving data locality in uniprocessors and multiprocessors.

1. We improve the temporal locality of computed results by trying to use the results as soon as they are generated. We do so by dividing a computation into independent partitions and executing all the dependent operations in each partition close together.
2. *Array contraction* reduces the dimensions of an array and reduces the number of memory locations accessed. We can apply array contraction if only one location of the array is used at a given time.
3. Besides improving temporal locality of computed results, we also need to optimize for the spatial locality of computed results, and for both the temporal and spatial locality of read-only data. Instead of executing each partition one after the other, we interleave a number of the partitions so that reuses among partitions occur close together.

### 11.10.1 Temporal Locality of Computed Data

The affine-partitioning algorithm pulls all the dependent operations together; by executing these partitions serially we improve temporal locality of computed data. Let us return to the multigrid example discussed in Section 11.7.1. Applying Algorithm 11.43 to parallelize the code in Fig 11.23 finds two degrees of parallelism. The code in Fig 11.24 contains two outer loops that iterate through the independent partitions serially. This transformed code has improved temporal locality, since computed results are used immediately in the same iteration.

Thus, even if our goal is to optimize for sequential execution, it is profitable to use parallelization to find these related operations and place them together. The algorithm we use here is similar to that of Algorithm 11.64, which finds all the granularities of parallelism starting with the outermost loop. As discussed in Section 11.9.9, the algorithm parallelizes strongly connected components individually, if we cannot find synchronization-free parallelism at each level. This parallelization tends to increase communication. Thus, we combine separately parallelized strongly connected components greedily, if they share reuse.

### 11.10.2 Array Contraction

The optimization of array contraction provides another illustration of the trade-off between storage and parallelism, which was first introduced in the context of instruction-level parallelism in Section 10.2.3. Just as using more registers allows for more instruction-level parallelism, using more memory allows for more loop-level parallelism. As shown in the multigrid example in Section 11.7.1, expanding a temporary scalar variable into an array allows different iterations to keep different instances of the temporary variables and to execute at the same time. Conversely, when we have a sequential execution that operates on one array element at a time serially, we can contract the array, replace it with a scalar, and have each iteration use the same location.

In the transformed multigrid program shown in Fig. 11.24, each iteration of the inner loop produces and consumes a different element of  $AP$ ,  $AM$ ,  $T$ , and a row of  $D$ . If these arrays are not used outside of the code excerpt, the iterations can serially reuse the same data storage instead of putting the values in different elements and rows, respectively. Figure 11.62 shows the result of reducing the dimensionality of the arrays. This code runs faster than the original, because it reads and writes less data. Especially in the case when an array is reduced to a scalar variable, we can allocate the variable to a register and eliminate the need to access memory altogether.

As less storage is used, less parallelism is available. Iterations in the transformed code in Fig. 11.62 now share data dependences and no longer can be executed in parallel. To parallelize the code on  $P$  processors, we can expand each of the scalar variables by a factor of  $P$  and have each processor access its own private copy. Thus, the amount by which the storage is expanded is

```

for (j = 2, j <= j1, j++)
  for (i = 2, i <= i1, i++) {
    AP
    T          = 1.0/(1.0 +AP);
    D[2]       = T*AP;
    DW[1,2,j,i] = T*DW[1,2,j,i];
    for (k=3, k <= k1-1, k++) {
      AM       = AP;
      AP       = ...;
      T        = ...AP -AM*D[k-1]...;
      D[k]     = T*AP;
      DW[1,k,j,i] = T*(DW[1,k,j,i]+DW[1,k-1,j,i])...;
    }

    for (k=k1-1, k>=2, k-)
      DW[1,k,j,i] = DW[1,k,j,i] +D[k] *DW[1,k+1,j,i];
  }

```

Figure 11.62: Code of Fig. 11.23 after partitioning (Fig. 11.24) and array contraction

directly correlated to the amount of parallelism exploited.

There are three reasons it is common to find opportunities for array contraction:

1. Higher-level programming languages for scientific applications, such as Matlab and Fortran 90, support array-level operations. Each subexpression of array operations produces a temporary array. Because the arrays can be large, every array operation such as a multiply or add would require reading and writing many memory locations, while requiring relatively few arithmetic operations. It is important that we reorder operations so that data is consumed as it is produced and that we contract these arrays into scalar variables.
2. Supercomputers built in the 80's and 90's are all vector machines, so many scientific applications developed then have been optimized for such machines. Even though vectorizing compilers exist, many programmers still write their code to operate on vectors at a time. The multigrid code example of this chapter is an example of this style.
3. Opportunities for contraction are also introduced by the compiler. As illustrated by variable  $T$  in the multigrid example, a compiler would expand arrays to improve parallelization. We have to contract them when the space expansion is not necessary.

Example 1T.67: The array expression  $Z = W + X + Y$  translates to

```

for (i=0; i<n; i++) T[i] = W[i] + X[i];
for (i=0; i<n; i++) Z[i] = T[i] + Y[i];

```

Rewriting the code as

```

for (i=0; i<n; i++) { T = W[i] + X[i]; Z[i] = T + Y[i] }

```

can speed it up considerably. Of course at the level of C code, we would not even have to use the temporary T, but could write the assignment to  $Z[i]$  as a single statement. However, here we are trying to model the intermediate-code level at which a vector processor would deal with the operations. •

Algorithm 11.68: Array contraction.

**INPUT:** A program transformed by Algorithm 11.64.

**OUTPUT:** An equivalent program with reduced array dimensions.

**METHOD:** A dimension of an array can be contracted to a single element if

1. Each independent partition uses only one element of the array,
2. The value of the element upon entry to the partition is not used by the partition, and
3. The value of the element is not live on exit from the partition.

Identify the contractable dimensions — those that satisfy the three conditions above — and replace them with a single element. •

Algorithm 11.68 assumes that the program has first been transformed by Algorithm 11.64 to pull all the dependent operations into a partition and execute the partitions sequentially. It finds those array variables whose elements' live ranges in different iterations are disjoint. If these variables are not live after the loop, it contracts the array and has the processor operate on the same scalar location. After array contraction, it may be necessary to selectively expand arrays to accommodate for parallelism and other locality optimizations.

The liveness analysis required here is more complex than that described in Section 9.2.5. If the array is declared as a global variable, or if it is a parameter, interprocedural analysis is required to ensure that the value on exit is not used. Furthermore, we need to compute the liveness of individual array elements, conservatively treating the array as a scalar would be too imprecise.

### 11.10.3 Partition Interleaving

Different partitions in a loop often read the same data, or read and write the same cache lines. In this and the next two sections, we discuss how to optimize for locality when reuse is found across partitions.

**Reuse in Innermost Blocks**

We adopt the simple model that data can be found in the cache if it is reused within a small number of iterations. If the innermost loop has a large or unknown bound, only reuse across iterations of the innermost loop translates into a locality benefit. Blocking creates inner loops with small known bounds, allowing reuse within and across entire blocks of computation to be exploited. Thus, blocking has the effect of capitalizing on more dimensions of reuse.

**Example 11.69:** Consider the matrix-multiply code shown in Fig. 11.5 and its blocked version in Fig. 11.7. Matrix multiplication has reuse along every dimension of its three-dimensional iteration space. In the original code, the innermost loop has  $n$  iterations, where  $n$  is unknown and can be large. Our simple model assumes that only the data reused across iterations in the innermost loop is found in the cache.

In the blocked version, the three innermost loops execute a three-dimensional block of computation, with  $B$  iterations on each side. The block size  $B$  is chosen by the compiler to be small enough so that all the cache lines read and written within the block of computation fit into the cache. Thus reused data across iterations in the third outermost loop can be found in the cache. •

We refer to the innermost set of loops with small known bounds as the *innermost block*. It is desirable that the innermost block include all the dimensions of the iteration space that carry reuse, if possible. Maximizing the lengths of each side of the block is not as important. For the matrix-multiply example, 3-dimensional blocking reduces the amount of data accessed for each matrix by a factor of  $B^2$ . If reuse is present, it is better to accommodate higher-dimensional blocks with shorter sides than lower-dimensional blocks with longer sides.

We can optimize locality of the innermost fully permutable loop nest by blocking the subset of loops that share reuse. We can generalize the notion of blocking to exploit reuses found among iterations of outer parallel loops, also. Observe that blocking primarily interleaves the execution of a small number of instances of the innermost loop. In matrix multiplication, each instance of the innermost loop computes one element of the array answer; there are  $n^2$  of them. Blocking interleaves the execution of a block of instances, computing  $B$  iterations from each instance at a time. Similarly, we can interleave iterations in parallel loops to take advantage of reuses between them.

We define two primitives below that can reduce the distance between reuses across different iterations. We apply these primitives repeatedly, starting from the outermost loop until all the reuses are moved adjacent to each other in the innermost block.

**Interleaving Inner Loops in a Parallel Loop**

Consider the case where an outer parallelizable loop contains an inner loop. To exploit reuse across iterations of the outer loop, we interleave the executions of

a fixed number of instances of the inner loop, as shown in Fig. 11.63. Creating two-dimensional inner blocks, this transformation reduces the distance between reuse of consecutive iterations of the outer loop.

```

for (i=0; i<n; i++)          for (ii=0; ii<n; ii+=4)
  for (j=0; j<n;             for (j=0; j<n;
    <S>                       for (i=ii; ii<min(n, ii+4); ii+=4)
                              <S>

```

(a) Source program.

(b) Transformed code.

Figure 11.63: Interleaving 4 instances of the inner loop

The step that turns a loop

```

for (i=0; i<n; i++)
  <S>

```

into

```

for (ii=0; ii<n; ii+=4)
  for (i=ii; ii<min(n, ii+4); ii+=4)
    <S>

```

is known as *stripmining*. In the case where the outer loop in Fig. 11.63 has a small known bound, we need not stripmine it, but can simply permute the two loops in the original program.

### Interleaving Statements in a Parallel Loop

Consider the case where a parallelizable loop contains a sequence of statements  $s_1, s_2, \dots, s_m$ . If some of these statements are loops themselves, statements from consecutive iterations may still be separated by many operations. We can exploit reuse between iterations by again interleaving their executions, as shown in Fig. 11.64. This transformation *distributes* a stripmined loop across the statements. Again, if the outer loop has a small fixed number of iterations, we need not stripmine the loop but simply distribute the original loop over all the statements.

We use  $Si(j)$  to denote the execution of statement  $s_i$  in iteration  $j$ . Instead of the original sequential execution order shown in Fig. 11.65(a), the code executes in the order shown in Fig. 11.65(b).

**Example 11.70:** We now return to the multigrid example and show how we exploit reuse between iterations of outer parallel loops. We observe that references  $DW[l, k, j, i]$ ,  $DW[l, k-l, j, i]$ , and  $DW[l, k+l, j, i]$  in the innermost loops of the code in Fig. 11.62 have rather poor spatial locality. From reuse analysis, as discussed in Section 11.5, the loop with index  $i$  carries spatial



```

for (i=0; i<n; i++) {
  <S1>
  <S2>
}

for (ii=0; ii<n; ii+=4) {
  for (i=ii; i<min(n,ii+4); i++)
    <S1>
  for (i=ii; i<rain(n,ii+4); i++)
    <S2>
}

```

(a) Source program.

(b) Transformed code.

Figure 11.64: The statement-interleaving transformation

locality and the loop with index  $k$  carries group reuse. The loop with index  $k$  is already the innermost loop, so we are interested in interleaving operations on  $DW$  from a block of partitions with consecutive  $i$  values.

We apply the transform to interleave statements in the loop to obtain the code in Fig. 11.66, then apply the transform to interleave inner loops to obtain the code in Fig. 11.67. Notice that as we interleave  $B$  iterations from loop with index  $i$ , we need to expand variables  $AP, AM, T$  into arrays that hold  $B$  results at a time. •

### 11.10.4 Putting it All Together

Algorithm 11.71 optimizes locality for a uniprocessor, and Algorithm 11.72 optimizes both parallelism and locality for a multiprocessor.

**Algorithm 11.71:** Optimize data locality on a uniprocessor.

**INPUT:** A program with affine array accesses.

**OUTPUT:** An equivalent program that maximizes data locality.

**METHOD:** Do the following steps:

1. Apply Algorithm 11.64 to optimize the temporal locality of computed results.
2. Apply Algorithm 11.68 to contract arrays where possible.
3. Determine the iteration subspace that may share the same data or cache lines using the technique described in Section 11.5. For each statement, identify those outer parallel loop dimensions that have data reuse.
4. For each outer parallel loop carrying reuse, move a block of the iterations into the innermost block by applying the interleaving primitives repeatedly.

$si(0),$	$\mathbf{5}_2(0),$	$\bullet,$	$s_m(0),$
	$\mathbf{5}_2(1),$	$\bullet j$	$\mathbf{5}_m(1),$
$*i(2),$	$\mathbf{5}_2(2),$	$\bullet \mathbf{5}$	$\mathbf{5}_{T0}(2),$
$\ll i(3),$	$\mathbf{5}_2(3),$	$\bullet \mathbf{5}$	$\mathbf{5}_m(3),$
$si(4),$	$\mathbf{5}_2(4),$	$\bullet \mathbf{5}$	$\mathbf{5}_{T0}(4),$
$\mathbf{5I}(5),$	$\mathbf{5}_2(5),$	$\bullet \mathbf{5}$	$\mathbf{5}_m(5),$
$\mathbf{5I}(6),$	$\ll 2(6),$	$\bullet,$	$\mathbf{3}_m(6),$
$*i(7),$	$\mathbf{82(I)},$	$\bullet \mathbf{5}$	$\mathbf{5}_{T0}(7),$

(a) Original order.

$\mathbf{81}$	$(0),$	$\mathbf{si}$	$(1),$	$si$	$(2),$	$\mathbf{si}$	$(3),$
$S_2$	$(0),$	$\mathbf{s}_2$	$(1),$	$S_2$	$(2),$	$\mathbf{s}_2$	$(3),$
	$\dots,$						
$\mathbf{Sm}$	$(0),$	$S_m$	$(1),$	$S_m$	$(2),$	$\mathbf{8}_m$	$(3),$
$\mathbf{81}$	$(4),$	$\mathbf{8i}$	$(5),$	$\mathbf{81}$	$(6),$	$\mathbf{8i}$	$(7),$
$\mathbf{s}_2$	$(4),$	$\mathbf{s}_2$	$(5),$	$\mathbf{s}_2$	$(6),$	$\mathbf{s}_2$	$(7),$
	$\dots j$						
$s_m$	$(4),$	$\mathbf{8}_{T0}$	$(5),$	$\mathbf{8}_m$	$(6),$	$s_m$	$(7)$

(b) Transformed order.

Figure 11.65: Distributing a stripmined loop

5. Apply blocking to the subset of dimensions in the innermost fully permutable loop nest that carries reuse.
6. Block outer fully permutable loop nest for higher levels of memory hierarchies, such as the third-level cache or the physical memory.
7. Expand scalars and arrays where necessary by the lengths of the blocks.

Algorithm 11.72: Optimize parallelism and data locality for multiprocessors.

**INPUT:** A program with affine array accesses.

**OUTPUT:** An equivalent program that maximizes parallelism and data locality.

**METHOD:** Do the following:

1. Use the Algorithm 11.64 to parallelize the program and create an SPMD program.

```

for (j = 2, j <= j1,
  for (ii = 2, ii <= il, ii+=b) {
    for (i = ii; i <= min(ii+b-1,il); i++) {
      ib      = i-ii+1;
      AP[ib]  = ...;
      T       = 1.0/(1.0 +AP[ib]);
      D[2,ib] = T*AP[ib];
      DW[1,2,j,i] = T*DW[1,2,j,i]J
    }
    for (i = ii; i <= min(ii+b-1,il); i++) {
      for (k=3, k <= kl-1, k++)
        ib      = i-ii+1;
        AM      = AP[ib];
        AP[ib]  = ...;
        T       = ...AP[ib]-AM*D[ib,k-1]...;
        D[ib,k] = T*AP;
        DW[1,k,j,i] = T*(DW[1,k,j,i]+DW[1,k-1,j,i])...;
      }

    for (i = ii; i <= min(ii+b-1,il); i++)
      for (k=kl-1, k>=2, k~) {
        DW[1,k,j,i] = DW[1,k,j,i] +D[iw,k]*DW[1,k+1,j,i];
        /* Ends code to be executed by processor (j,i) */
      }
  }
}

```

Figure 11.66: Excerpt of Fig. 11.23 after partitioning, array contraction, and blocking

2. Apply Algorithm 11.71 to the SPMD program produced in Step 1 to optimize its locality.

### 11.10.5 Exercises for Section 11.10

Exercise 11.10.1: Perform array contraction on the following vector operations:

```

for (i=0; i<n; i++) T[i] = A[i] * B[i];
for (i=0; i<n; i++) D[i] = T[i] + C[i];

```

Exercise 11.10.2: Perform array contraction on the following vector operations:

```

for (j = 2, j <= j1, j++)
  for (ii = 2, ii <= i1, ii+=b) {
    for (i = ii; i <= min(ii+b-1,i1); i++) {
      ib      = i-ii+1;
      AP[ib]  = ...;
      T       = 1.0/(1.0 +AP[ib]);
      D[2,ib] = T*AP[ib];
      DW[1,2,j,i] = T*DW[1,2,j,i];
    }
    for (k=3, k <= k1-1, k++)
      for (i = ii; i <= min(ii+b-1,i1); i++) {
        ib      = i-ii+1;
        AM      = AP[ib];
        AP[ib]  = ...;
        T       = ...AP[ib]-AM*D[ib,k-1]...;
        D[ib,k] = T*AP;
        DW[1,k,j,i] = T*(DW[1,k,j,i]+DW[1,k-1,j,i])...;
      }

    for (k=k1-1, k>=2, k-) {
      for (i = ii; i <= min(ii+b-1,i1); i++)
        DW[1,k,j,i] = DW[1,k,j,i] +D[iw,k]*DW[1,k+1,j,i];
      /* Ends code to be executed by processor (j,i) */
    }
  }
}

```

Figure 11.67: Excerpt of Fig. 11.23 after partitioning, array contraction, and blocking

```

for (i=0; i<n; i++) T[i] = A[i] + B[i];
for (i=0; i<n; i++) S[i] = C[i] + D[i];
for (i=0; i<n; i++) E[i] = T[i] * S[i];

```

Exercise 11.10.3: Stripmine the outer loop

```

for (i=n-1; i>=0; i-)
  for (j=0; j<n; j++)

```

into strips of width 10.

## 11.11 Other Uses of Affine Transforms

So far we have focused on the architecture of shared memory machines, but the theory of affine loop transforms has many other applications. We can apply affine transforms to other forms of parallelism including distributed memory

machines, vector instructions, SIMD (Single Instruction Multiple Data) instructions, as well as multiple-instruction-issue machines. The reuse analysis introduced in this chapter also is useful for data *prefetching*, which is an effective technique for improving memory performance.

### 11.11.1 Distributed Memory Machines

For distributed memory machines, where processors communicate by sending messages to each other, it is even more important that processors be assigned large, independent units of computation, such as those generated by the affine-partitioning algorithm. Besides computation partitioning, a number of additional compilation issues remain:

1. *Data allocation.* If processors use different portions of an array, they each only have to allocate enough space to hold the portion used. We can use projection to determine the section of arrays used by each processor. The input is the system of linear inequalities representing the loop bounds, the array access functions, and the affine partitions that map the iterations to processor IDs. We project away the loop indices and find for each processor ID the set of array locations used.
2. *Communication code.* We need to generate explicit code to send and receive data to and from other processors. At each synchronization point
  - (a) Determine the data residing on one processor that is needed by other processors.
  - (b) Generate the code that finds all the data to be sent and packs it into a buffer.
  - (c) Similarly, determine the data needed by the processor, unpack received messages, and move the data to the right memory locations.

Again, if all accesses are affine, these tasks can be performed by the compiler, using the affine framework.

3. *Optimization.* It is not necessary for all the communications to take place at the synchronization points. It is preferable that each processor sends data as soon as it is available, and that each processor does not start waiting for data until it is needed. Such optimizations must be balanced by the goal of not generating too many messages, since there is a nontrivial overhead associated with processing each message.

Techniques described here have other applications as well. For example, a special-purpose embedded system may use coprocessors to offload some of its computations. Or, instead of demand fetching data into the cache, an embedded system may use a separate controller to load and unload data into and out of the cache, or other data buffers, while the processor operates on other data. In these cases, similar techniques can be used to generate the code to move data around.

### 11.11.2 Multi-Instruction-Issue Processors

We can also use affine loop transforms to optimize the performance of multi-instruction-issue machines. As discussed in Chapter 10.5, the performance of a software-pipelined loop is limited by two factors: cycles in precedence constraints and the usage of the critical resource. By changing the makeup of the innermost loop, we can improve these limits.

First, we may be able to use loop transforms to create innermost parallelizable loops, thus eliminating precedence cycles altogether. Suppose a program has two loops, with the outer being parallelizable and the inner not. We can permute the two loops to make the inner loop parallelizable and so create more opportunities for instruction-level parallelism. Notice that it is not necessary for iterations in the innermost loop to be completely parallelizable. It is sufficient that the cycle of dependences in the loop be short enough so that all the hardware resources are fully utilized.

We can also relax the limit due to resource usage by improving the usage balance inside a loop. Suppose one loop only uses the adder, and another uses only the multiplier. Or, suppose one loop is memory bound and another is compute bound. It is desirable to fuse each pair of loops in these examples together so as to utilize all the functional units at the same time.

### 11.11.3 Vector and SIMD Instructions

Besides multiple-instruction issue, there are two other important forms of instruction-level parallelism: vector and SIMD operations. In both cases, the issue of just one instruction causes the same operation to be applied to a vector of data.

As mentioned previously, many early supercomputers used vector instructions. Vector operations are performed in a pipelined manner; the elements in the vector are fetched serially and computations on different elements are overlapped. In advanced vector machines, vector operations can be *chained*: as the elements of the vector results are produced, they are immediately consumed by operations of another vector instruction without having to wait for all the results to be ready. Moreover, in advanced machines with *scatter/gather* hardware, the elements of the vectors need not be contiguous; an index vector is used to specify where the elements are located.

SIMD instructions specify that the same operation be performed on contiguous memory locations. These instructions load data from memory in parallel, store them in wide registers, and compute on them using parallel hardware. Many media, graphics, and digital-signal-processing applications can benefit from these operations. Low-end media processors can achieve instruction-level parallelism simply by issuing one SIMD instruction at a time. Higher-end processors can combine SIMD with multiple-instruction issue to achieve higher performance.

SIMD and vector instruction generation share many similarities with locality

optimization. As we find independent partitions that operate on contiguous memory locations, we stripmine those iterations and interleave these operations in innermost loops.

SIMD instruction generation poses two additional difficulties. First, some machines require that the SIMD data fetched from memory be aligned. For example, they might require that 256-byte SIMD operands be placed in addresses that are multiples of 256. If the source loop operates on just one array of data, we can generate one main loop that operates on aligned data and extra code before and after the loop to handle those elements at the boundary. For loops operating on more than one array, however, it may not be possible to align all the data at the same time. Second, data used by consecutive iterations in a loop may not be contiguous. Examples include many important digital-signal-processing algorithms, such as Viterbi decoders and fast Fourier transforms. Additional operations to shuffle the data around may be necessary to take advantage of the SIMD instructions.

#### 11.11.4 Prefetching

No data-locality optimization can eliminate all memory accesses; for one, data used for the first time must be fetched from memory. To hide the latency of memory operations, *prefetch instructions* have been adopted in many high-performance processors. Prefetch is a machine instruction that indicates to the processor that certain data is likely to be used soon, and that it is desirable to load the data into the cache if it is not present already.

The reuse analysis described in Section 11.5 can be used to estimate when caches misses are likely. There are two important considerations when generating prefetch instructions. If contiguous memory locations are to be accessed, we need to issue only one prefetch instruction for each cache line. Prefetch instructions should be issued early enough so that the data is in the cache by the time it are used. However, we should not issue prefetch instructions too far in advance. The prefetch instructions can displace data that may still be needed; also the prefetched data may be flushed before it is used.

Example 11.73: Consider the following code:

```
for (i=0; i<3; i++)
  for (j=0; j<100; j++)
    A[i,j] = ...;
```

Suppose the target machine has a prefetch instruction that can fetch two words of data at a time, and that the latency of a prefetch instruction takes about the time to execute six iterations of the loop above. The prefetch code for the above example is shown in Fig. 11.68.

We unroll the innermost loop twice, so a prefetch can be issued for each cache line. We use the concept of software pipelining to prefetch data six iterations before it is used. The prolog fetches the data used in the first six iterations. The

```

for (i=0; i<3; i++) {
  for (j=0; j<6; j+=2)
    prefetch(&A[i,j]);
  for (j=0; j<94; j+=2) {
    prefetch(&A[i,j+6]);
    A[i, j] = . . . ;
    A[i,j+1] =
  }
  for (j=94; j<100; j++)
    A[i,j] =
}

```

Figure 11.68: Code modified to prefetch data

steady state loop prefetches six iterations ahead as it performs its computation. The epilog issues no prefetches, but simply executes the remaining iterations.

•

## 11.12 Summary of Chapter 11

- *Parallelism and Locality from Arrays.* The most important opportunities for both parallelism and locality-based optimizations come from loops that access arrays. These loops tend to have limited dependences among accesses to array elements and tend to access arrays in a regular pattern, allowing efficient use of the cache for good locality.
- *Affine Accesses.* Almost all theory and techniques for parallelism and locality optimization assume accesses to arrays are affine: the expressions for the array indexes are linear functions of the loop indexes.
- 4- *Iteration Spaces.* A loop nest with  $d$  nested loops defines a  $d$ -dimensional iteration space. The points in the space are the  $d$ -tuples of values that the loop indexes can assume during the execution of the loop nest. In the affine case, the limits on each loop index are linear functions of the outer loop indexes, so the iteration space is a polyhedron.
- *Fourier-Motzkin Elimination.* A key manipulation of iteration spaces is to reorder the loops that define the iteration space. Doing so requires that a polyhedral iteration space be projected onto a subset of its dimensions. The Fourier-Motzkin algorithm replaces the upper and lower limits on a given variable by inequalities between the limits themselves.
- *Data Dependences and Array Accesses.* A central problem we must solve in order to manipulate loops for parallelism and locality optimizations is whether two array accesses have a data dependence (can touch the



same array element). When the accesses and loop bounds are affine, the problem can be expressed as whether there are solutions to a matrix-vector equation within the polyhedron that defines the iteration space.

- *Matrix Rank and Data Reuse.* The matrix that describes an array access can tell us several important things about that access. If the rank of the matrix is as large as possible (minimum of the number of rows and number of columns), then the access never touches the same element twice as the loops iterate. If the array is stored in row- (column-)major form, then the rank of the matrix with the last (first) row deleted tells us whether the access has good locality; i.e., elements in a single cache line are accessed at about the same time.
- *Data Dependence and Diophantine Equations.* Just because two accesses to the same array touch the same region of the array does not mean that they actually access any element in common. The reason is that each may skip some elements; e.g., one accesses even elements and the other accesses odd elements. In order to be sure that there is a data dependence, we must solve a Diophantine (integer solutions only) equation.
- 4- *Solving Diophantine Linear Equations.* The key technique is to compute the greatest common divisor (GCD) of the coefficients of the variables. Only if that GCD divides the constant term will there be integer solutions.
- *Space-Partition Constraints.* To parallelize the execution of a loop nest, we need to map the iterations of the loop to a space of processors, which can have one or more dimensions. The space-partition constraints say that if two accesses in two different iterations share a data dependence (i.e., they access the same array element), then they must map to the same processor. As long as the mapping of iterations to processors is affine, we can formulate the problem in matrix-vector terms.
- *Primitive Code Transformations.* The transformations used to parallelize programs with affine array accesses are combinations of seven primitives: loop fusion, loop fission, re-indexing (adding a constant to loop indexes), scaling (multiplying loop indexes by a constant), reversal (of a loop index), permutation (of the order of loops), and skewing (rewriting loops so the line of passage through the iteration space is no longer along one of the axes).
- *Synchronization of Parallel Operations.* Sometimes more parallelism can be obtained if we insert synchronization operations between steps of a program. For example, consecutive loop nests may have data dependences, but synchronizations between the loops can allow the loops to be parallelized separately.
- *Pipelining.* This parallelization technique allows processors to share data, by synchronously passing certain data (typically array elements) from one

processor to an adjacent processor in the processor space. The method can improve the locality of the data accessed by each processor.

- 4 *Time-Partition Constraints.* To discover opportunities for pipelining, we need to discover solutions to the time-partition constraints. These say that whenever two array accesses can touch the same array element, then the access in the iteration that occurs first must be assigned to a stage in the pipeline that occurs no later than the stage to which the second access is assigned.
- 4- *Solving Time-Partition Constraints.* Farkas' Lemma provides a powerful technique for finding all the affine time-partition mappings that are allowed by a given loop nest with array accesses. The technique is essentially to replace the primal formulation of the linear inequalities that express the time-partition constraints by their dual.
  - *Blocking.* This technique breaks each of several loops in a loop nest into two loops each. The advantage is that doing so may allow us to work on small sections (blocks) of a multidimensional array, one block at a time. That, in turn, improves the locality of the program, letting all the needed data reside in the cache while working on a single block.
  - *Stripmining.* Similar to blocking, this technique breaks only a subset of the loops of a loop nest into two loops each. A possible advantage is that a multidimensional array is accessed a "strip" at a time, which may lead to the best possible cache utilization.

## 11.13 References for Chapter 11

For detailed discussions of multiprocessor architectures, we refer the reader to the text by Hennessy and Patterson [9].

Lamport [13] and Kuck, Muraoka, and Chen [6] introduced the concept of data-dependence analysis. Early data-dependence tests used heuristics to prove a pair of references to be independent by determining if there are no solutions to Diophantine equations and systems of real linear inequalities: [5, 6, 26]. Maydan, Hennessy, and Lam [18] formulated the data-dependence test as integer linear programming and showed that the problem can be solved exactly and efficiently in practice. The data-dependence analysis described here is based on work by Maydan, Hennessy, and Lam [18] and Pugh and Wonnacott [23], which in turn use techniques of Fourier-Motzkin elimination [7] and Shostak's algorithm [25].

The 70's and early 80's saw the use of loop transformations to improve vectorization and parallelization: loop fusion [3], loop fission [1], stripmining [17], and loop interchange [28]. There were three major experimental parallelizer/vectorizing projects going on at the time: Parafrase led by Kuck at the University of Illinois Urbana-Champaign [21], the PFC project led by Kennedy

at Rice University [4], and the PTRAN project led by Allen at IBM Research [2].

McKellar and Coffman [19] first discussed using blocking to improve data locality. Lam, Rothbert, and Wolf [12] provided the first in-depth empirical analysis of blocking on caches for modern architectures. Wolf and Lam [27] used linear-algebra techniques to compute data reuse in loops. Sarkar and Gao [24] introduced the optimization of array contraction.

Lamport [13] was the first to model loops as iteration spaces and used hyperplaning (a special case of an affine transform) to find parallelism for multiprocessors. Affine transforms have their root in systolic-array algorithm design [11]. Intended as parallel algorithms directly implemented in VLSI, systolic arrays require communication to be minimized along with parallelization. Algebraic techniques were developed to map the computation onto space and time coordinates. The concept of an affine schedule and the use of Farkas' Lemma in affine transformations were introduced by Feautrier [8]. The affine-transformation algorithm described here is based on work by Lim et al. [15, 14, 16].

Porterfield [22] proposed one of the first compiler algorithms to prefetch data. Mowry, Lam, and Gupta [20] applied reuse analysis to minimize the prefetch overhead and gain an overall performance improvement.

1. Abu-Sufah, W., D. J. Kuck, and D. H. Lawrie, "On the performance enhancement of paging systems through program analysis and transformations," *IEEE Trans. on Computing* C-30:5 (1981), pp. 341-356.
2. Allen, F. E., M. Burke, P. Charles, R. Cytron, and J. Ferrante, "An overview of the PTRAN analysis system for multiprocessing," *J. Parallel and Distributed Computing* 5:5 (1988), pp. 617-640.
3. Allen, F. E. and J. Cocke, "A Catalogue of optimizing transformations," in *Design and Optimization of Compilers* (R. Rustin, ed.), pp. 1-30, Prentice-Hall, 1972.
4. Allen, R. and K. Kennedy, "Automatic translation of Fortran programs to vector form," *ACM Transactions on Programming Languages and Systems* 9:4 (1987), pp. 491-542.
5. Banerjee, U., *Data Dependence in Ordinary Programs*, Master's thesis, Department of Computer Science, University of Illinois Urbana-Champaign, 1976.
6. Banerjee, U., *Speedup of Ordinary Programs*, Ph.D. thesis, Department of Computer Science, University of Illinois Urbana-Champaign, 1979.
7. Dantzig, G. and B. C. Eaves, "Fourier-Motzkin elimination and its dual," *J. Combinatorial Theory*, A(14) (1973), pp. 288-297.
8. Feautrier, P., "Some efficient solutions to the affine scheduling problem: I. One-dimensional time," *International J. Parallel Programming* 21:5 (1992), pp. 313-348,

9. Hennessy, J. L. and D. A. Patterson, *Computer Architecture: A Quantitative Approach*, Third Edition, Morgan Kaufman, San Francisco, 2003.
10. Kuck, D., Y. Muraoka, and S. Chen, "On the number of operations simultaneously executable in Fortran-like programs and their resulting speedup," *IEEE Transactions on Computers* C-21:12 (1972), pp. 1293-1310.
11. Kung, H. T. and C. E. Leiserson, "Systolic arrays (for VLSI)," in Duff, I. S. and G. W. Stewart (eds.), *Sparse Matrix Proceedings* pp. 256-282. Society for Industrial and Applied Mathematics, 1978.
12. Lam, M. S., E. E. Rothberg, and M. E. Wolf, "The cache performance and optimization of blocked algorithms," *Proc. Sixth International Conference on Architectural Support for Programming Languages and Operating Systems* (1991), pp. 63-74.
13. Lamport, L., "The parallel execution of DO loops," *Comm. ACM* 17:2 (1974), pp. 83-93.
14. Lim, A. W., G. I. Cheong, and M. S. Lam, "An affine partitioning algorithm to maximize parallelism and minimize communication," *Proc. 13th International Conference on Supercomputing* (1999), pp. 228-237.
15. Lim, A. W. and M. S. Lam, "Maximizing parallelism and minimizing synchronization with affine transforms," *Proc. 24th ACM SIGPLAN-SIGACT Symposium on Principles of Programming Languages* (1997), pp. 201-214.
16. Lim, A. W., S.-W. Liao, and M. S. Lam, "Blocking and array contraction across arbitrarily nested loops using affine partitioning," *Proc. ACM SIGPLAN Symposium on Principles and Practice of Parallel Programming* (2001), pp. 103-112.
17. Loveman, D. B., "Program improvement by source-to-source transformation," *J. ACM* 24:1 (1977), pp. 121-145.
18. Maydan, D. E., J. L. Hennessy, and M. S. Lam, "An efficient method for exact dependence analysis," *Proc. ACM SIGPLAN 1991 Conference on Programming Language Design and Implementation*, pp. 1-14.
19. McKeller, A. C. and E. G. Coffman, "The organization of matrices and matrix operations in a paged multiprogramming environment," *Comm. ACM*, 12:3 (1969), pp. 153-165.
20. Mowry, T. C, M. S. Lam, and A. Gupta, "Design and evaluation of a compiler algorithm for prefetching," *Proc. Fifth International Conference on Architectural Support for Programming Languages and Operating Systems* (1992), pp. 62-73.

21. Padua, D. A. and M. J. Wolfe, "Advanced compiler optimizations for supercomputers," *Comm. ACM*, 29:12 (1986), pp. 1184-1201.
22. Porterfield, A., *Software Methods for Improving Cache Performance on Supercomputer Applications*, Ph.D. Thesis, Department of Computer Science, Rice University, 1989.
23. Pugh, W. and D. Wonnacott, "Eliminating false positives using the omega test," *Proc. ACM SIGPLAN 1992 Conference on Programming Language Design and Implementation*, pp. 140-151.
24. Sarkar, V. and G. Gao, "Optimization of array accesses by collective loop transformations," *Proc. 5th International Conference on Supercomputing* (1991), pp. 194-205.
25. R. Shostak, "Deciding linear inequalities by computing loop residues," *J. ACM*, 28:4 (1981), pp. 769-779.
26. Towle, R. A., *Control and Data Dependence for Program Transformation*, Ph.D. thesis, Department of Computer Science, University of Illinois Urbana-Champaign, 1976.
27. Wolf, M. E. and M. S. Lam, "A data locality optimizing algorithm," *Proc. SIGPLAN 1991 Conference on Programming Language Design and Implementation*, pp. 30-44.
28. Wolfe, M. J., *Techniques for Improving the Inherent Parallelism in Programs*, Master's thesis, Department of Computer Science, University of Illinois Urbana-Champaign, 1978.

## Chapter 12

# Interprocedural Analysis

In this chapter, we motivate the importance of interprocedural analysis by discussing a number of important optimization problems that cannot be solved with intraprocedural analysis. We begin by describing the common forms of interprocedural analysis and explaining the difficulties in their implementation. We then describe applications for interprocedural analysis. For widely used programming languages like C and Java, pointer alias analysis is key to any interprocedural analysis. Thus, for much of the chapter, we discuss techniques needed to compute pointer aliases. To start, we present Datalog, a notation that greatly hides the complexity of an efficient pointer analysis. We then describe an algorithm for pointer analysis, and show how we use the abstraction of binary decision diagrams (BDD's) to implement the algorithm efficiently.

Most compiler optimizations, including those described in Chapters 9, 10, and 11, are performed on procedures one at a time. We refer to such analyses as *intraprocedural*. These analyses conservatively assume that procedures invoked may alter the state of all the variables visible to the procedures and that they may create all possible side effects, such as modifying any of the variables visible to the procedure or generating exceptions that cause the unwinding of the call stack. Intraprocedural analysis is thus relatively simple, albeit imprecise. Some optimizations do not need interprocedural analysis, while others may yield almost no useful information without it.

An interprocedural analysis operates across an entire program, flowing information from the caller to its callees and vice versa. One relatively simple but useful technique is to *inline* procedures, that is, to replace a procedure invocation by the body of the procedure itself with suitable modifications to account for parameter passing and the return value. This method is applicable only if we know the target of the procedure call.

If procedures are invoked indirectly through a pointer or via the method-dispatch mechanism prevalent in object-oriented programming, analysis of the program's pointers or references can in some cases determine the targets of the indirect invocations. If there is a unique target, inlining can be applied.

Even if a unique target is determined for each procedure invocation, inlining must be applied judiciously. In general, it is not possible to inline recursive procedures directly, and even without recursion, inlining can expand the code size exponentially.

## 12.1 Basic Concepts

In this section, we introduce call graphs — graphs that tell us which procedures can call which. We also introduce the idea of "context sensitivity," where data-flow analyses are required to take cognizance of what the sequence of procedure calls has been. That is, context-sensitive analysis includes (a synopsis of) the current sequence of activation records on the stack, along with the current point in the program, when distinguishing among different "places" in the program.

### 12.1.1 Call Graphs

A *call graph* for a program is a set of nodes and edges such that

1. There is one node for each procedure in the program.
2. There is one node for each *call site*, that is, a place in the program where a procedure is invoked.
3. If call site *c* may call procedure *p*, then there is an edge from the node for *c* to the node for *p*.

Many programs written in languages like C and Fortran make procedure calls directly, so the call target of each invocation can be determined statically. In that case, each call site has an edge to exactly one procedure in the call graph. However, if the program includes the use of a procedure parameter or function pointer, the target generally is not known until the program is run and, in fact, may vary from one invocation to another. Then, a call site can link to many or all procedures in the call graph.

Indirect calls are the norm for object-oriented programming languages. In particular, when there is overriding of methods in subclasses, a use of method *m* may refer to any of a number of different methods, depending on the subclass of the receiver object to which it was applied. The use of such *virtual* method invocations means that we need to know the type of the receiver before we can determine which method is invoked.

**Example 12.1:** Figure 12.1 shows a C program that declares *pf* to be a global pointer to a function whose type is "integer to integer." There are two functions of this type, *f un1* and *f un2*, and a main function that is not of the type that *pf* points to. The figure shows three call sites, denoted *c1*, *c2*, and *c3*; the labels are not part of the program.

```

int (*pf)(int);

int fun1(int x) {
  if (x < 10)
c1:    return (*pf)(x+1);
  else
    return x;
}

int fun2(int y) {
c2:    pf = &fun1;
    return (*pf)(y);
}

void main() {
c3:    pf = &fun2;
    (*pf)(5);
}

```

Figure 12.1: A program with a function pointer

The simplest analysis of what `pf` could point to would simply observe the types of functions. Functions `fun1` and `fun2` are of the same type as what `pf` points to, while `main` is not. Thus, a conservative call graph is shown in Fig. 12.2(a). A more careful analysis of the program would observe that `pf` is made to point to `fun2` in `main` and is made to point to `fun1` in `fun2`. But there are no other assignments to any pointer, so, in particular, there is no way for `pf` to point to `main`. This reasoning yields the same call graph as Fig. 12.2(a).

An even more precise analysis would say that at `c3`, it is only possible for `pf` to point to `fun2`, because that call is preceded immediately by that assignment to `pf`. Similarly, at `c2` it is only possible for `pf` to point to `fun1`. As a result, the initial call to `fun1` can come only from `fun2`, and `fun1` does not change `pf`, so whenever we are within `fun1`, `pf` points to `fun1`. In particular, at `c1`, we can be sure `pf` points to `fun1`. Thus, Fig. 12.2(b) is a more precise, correct call graph. •

In general, the presence of references or pointers to functions or methods requires us to get a static approximation of the potential values of all procedure parameters, function pointers, and receiver object types. To make an accurate approximation, interprocedural analysis is necessary. The analysis is iterative, starting with the statically observable targets. As more targets are discovered, the analysis incorporates the new edges into the call graph and repeats discovering more targets until convergence is reached.



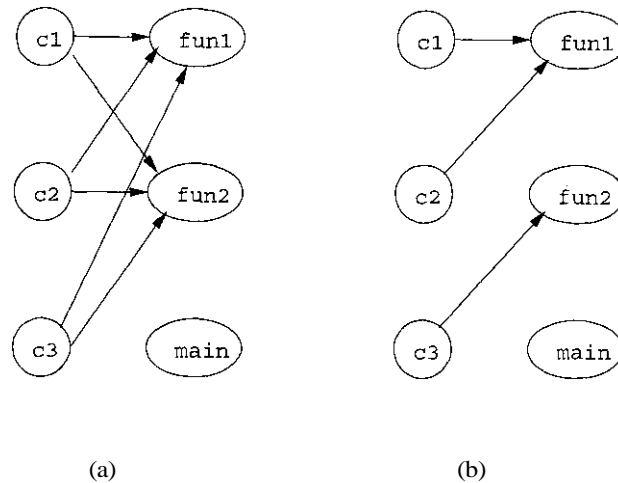

Figure 12.2: Call graphs derived from Fig. 12.1

### 12.1.2 Context Sensitivity

Interprocedural analysis is challenging because the behavior of each procedure is dependent upon the context in which it is called. Example 12.2 uses the problem of interprocedural constant propagation on a small program to illustrate the significance of contexts.

**Example 12\*2:** Consider the program fragment in Fig. 12.3. Function  $f$  is invoked at three call sites:  $c1$ ,  $c2$  and  $c3$ . Constant 0 is passed in as the actual parameter at  $c1$ , and constant 243 is passed in at  $c2$  and  $c3$  in each iteration; the constants 1 and 244 are returned, respectively. Thus, function  $f$  is invoked with a constant in each of the contexts, but the value of the constant is context-dependent.

As we shall see, it is not possible to tell that  $t1$ ,  $t2$ , and  $t3$  each are assigned constant values (and thus so is  $X[i]$ ), unless we recognize that when called in context  $c1$ ,  $f$  returns 1, and when called in the other two contexts,  $f$  returns 244. A naive analysis would conclude that  $f$  can return either 1 or 244 from any call. •

One simplistic but extremely inaccurate approach to interprocedural analysis, known as *context-insensitive analysis*, is to treat each call and return statement as "goto" operations. We create a *super* control-flow graph where, besides the normal intraprocedural control flow edges, additional edges are created connecting

1. Each call site to the beginning of the procedure it calls, and
2. The return statements back to the call sites.<sup>1</sup>

<sup>1</sup>The return is actually to the instruction following the call site.

```

        for (i = 0; i < n; i++) {
c1:         t1 = f(0);
c2:         t2 = f(243);
c3:         t3 = f(243);
            x[i] = t1+t2+t3;
        }

        int f (int v) {
            return (v+1);
        }

```

Figure 12.3: A program fragment illustrating the need for context-sensitive analysis

Assignment statements are added to assign each actual parameter to its corresponding formal parameter and to assign the returned value to the variable receiving the result. We can then apply a standard analysis intended to be used within a procedure to the super control-flow graph to find context-insensitive interprocedural results. While simple, this model abstracts out the important relationship between input and output values in procedure invocations, causing the analysis to be imprecise.

**Example 12.3:** The super control-flow graph for the program in Fig. 12.3 is shown in Figure 12.4. Block *BQ* is the function *f*. Block *B3* contains the call site *c1*; it sets the formal parameter *v* to 0 and then jumps to the beginning of *f*, at *BQ*. Similarly, *B4* and *B5* represent the call sites *c2* and *c3*, respectively. In *B4*, which is reached from the end of *f* (block *BQ*), we take the return value from *f* and assign it to *t1*. We then set formal parameter *v* to 243 and call *f* again, by jumping to *B5*. Note that there is no edge from *B3* to *B4*. Control must flow through *f* on the way from *B3* to *B4*.

*B5* is similar to *B4*. It receives the return from *f*, assigns the return value to *t2*, and initiates the third call to *f*. Block *B7* represents the return from the third call and the assignment to *X[i]*.

If we treat Fig. 12.4 as if it were the flow graph of a single procedure, then we would conclude that coming into *BQ*, *v* can have the value 0 or 243. Thus, the most we can conclude about *retval* is that it is assigned 1 or 244, but no other value. Similarly, we can only conclude about *t1*, *t2*, and *t3* that they can each be either 1 or 244. Thus, *X[i]* appears to be either 3, 246, 489, or 732. In contrast, a context-sensitive analysis would separate the results for each of the calling contexts and produces the intuitive answer described in Example 12.2: *t1* is always 1, *t2* and *t3* are always 244, and *X[i]* is 489. •

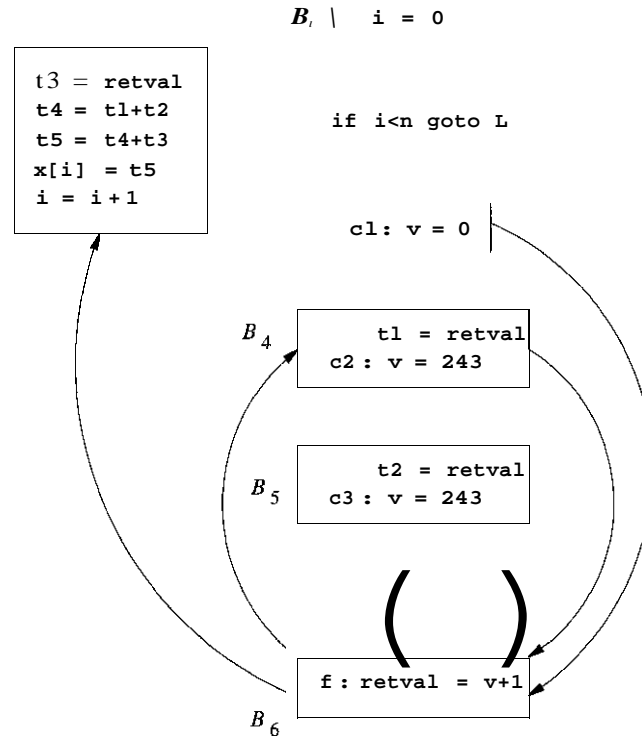

Figure 12.4: The control-flow graph for Fig. 12.3, treating function calls as control flow

### 12.1.3 Call Strings

In Example 12.2, we can distinguish among the contexts by just knowing the call site that calls the procedure  $f$ . In general, a calling context is defined by the contents of the entire call stack. We refer to the string of call sites on the stack as the *call string*.

**Example 12.4:** Figure 12.5 is a slight modification of Fig. 12.3. Here we have replaced the calls to  $f$  by calls to  $g$ , which then calls  $f$  with the same argument. There is an additional call site,  $c4$ , where  $g$  calls  $f$ .

There are three call strings to  $f$ :  $(c1, c4)$ ,  $(c2, c4)$ , and  $(c3, c4)$ . As we see in this example, the value of  $v$  in function  $f$  depends not on the immediate or last site  $c4$  on the call string. Rather, the constants are determined by the first element in each of the call strings. •

Example 12.4 illustrates that information relevant to the analysis can be introduced early in the call chain. In fact, it is sometimes necessary to consider the entire call string to compute the most precise answer, as illustrated in Example 12.5.

```

        for (i = 0; i < n; i++) {
c1:          t1 = g(0);
c2:          t2 = g(243);
c3:          t3 = g(243);
              X[i] = t1+t2+t3;
        }

int g (int v) {
c4:      return f(v);
}

int f (int v) {
        return (v+1);
}

```

Figure 12.5: Program fragment illustrating call strings

```

        for (i = 0; i < n; i++) {
c1:          t1 = g(0);
c2:          t2 = g(243);
c3:          t3 = g(243);
              X[i] = t1+t2+t3;
        }

int g (int v) {
        if (v > 1) {
c4:          return g(v-1);
        } else {
c5:          return f(v);
        }
}

int f (int v) {
        return (v+1);
}

```

Figure 12.6: Recursive program requiring analysis of complete call strings

Example 12.5: This example illustrates how the ability to reason about unbounded call strings can yield more precise results. In Fig. 12.6 we see that if  $g$  is called with a positive value  $c$ , then  $g$  will be invoked recursively  $c$  times. Each time  $g$  is called, the value of its parameter  $v$  decreases by 1. Thus, the value of  $g$ 's parameter  $v$  in the context whose call string is  $c2(c4)^n$  is  $243 - n$ . The effect of  $g$  is thus to increment 0 or any negative argument by 1, and to return 2 on any argument 1 or greater.

There are three possible call strings for  $/$ . If we start with the call at  $c1$ , then  $g$  calls  $/$  immediately, so  $(c1, c5)$  is one such string. If we start at  $c2$  or  $c3$ , then we call  $g$  a total of 243 times, and then call  $/$ . These call strings are  $(c2, c4, c4, \dots, c5)$  and  $(c3, c4, c4, \dots, c5)$ , where in each case there are 242  $c4$ 's in the sequence. In the first of these contexts, the value of  $/$ 's parameter  $v$  is 0, while in the other two contexts it is 1. •

In designing a context-sensitive analysis, we have a choice in precision. For example, instead of qualifying the results by the full call string, we may just choose to distinguish between contexts by their  $k$  most immediate call sites. This technique is known as *fc-limiting context analysis*. Context-insensitive analysis is simply a special case of *fc-limiting context analysis*, where  $k$  is 0. We can find all the constants in Example 12.2 using a 1-limiting analysis and all the constants in Example 12.4 using a 2-limiting analysis. However, no  $\wedge$ -limiting analysis can find all the constants in Example 12.5, provided the constant 243 were replaced by two different and arbitrarily large constants.

Instead of choosing a fixed value  $k$ , another possibility is to be fully context sensitive for all *acyclic* call strings, which are strings that contain no recursive cycles. For call strings with recursion, we can collapse all recursive cycles, in order to bound the number of different contexts analyzed. In Example 12.5, the calls initiated at call site  $c2$  may be approximated by the call string:  $(c2, c4^*, c5)$ . Note that, with this scheme, even for programs without recursion, the number of distinct calling contexts can be exponential in the number of procedures in the program.

### 12.1.4 Cloning-Based Context-Sensitive Analysis

Another approach to context-sensitive analysis is to clone the procedure conceptually, one for each unique context of interest. We can then apply a context-insensitive analysis to the cloned call graph. Examples 12.6 and 12.7 show the equivalent of a cloned version of Examples 12.4 and 12.5, respectively. In reality, we do not need to clone the code, we can simply use an efficient internal representation to keep track of the analysis results of each clone.

Example 12.6: The cloned version of Fig. 12.5 is shown in Fig. 12.7. Because every calling context refers to a distinct clone, there is no confusion. For example,  $g1$  receives 0 as input and produces 1 as output, and  $g2$  and  $g3$  both receive 243 as input and produce 244 as output. •

```

        for (i = 0; i < n; i++) {
c1:          t1 = g1(0);
c2:          t2 = g2(243);
c3:          t3 = g3(243);
              X[i] = t1+t2+t3;
        }
    int g1 (int v) {
c4.1:        return f1(v);
    }
    int g2 (int v) {
c4.2:        return f2(v);
    }
    int g3 (int v) {
c4.3:        return f3(v);
    }

    int f1 (int v) {
        return (v+1);
    }
    int f2 (int v) {
        return (v+1);
    }
    int f3 (int v) {
        return (v+1);
    }

```

Figure 12.7: Cloned version of Fig. 12.5

Example 12.7: The cloned version of Example 12.5 is shown in Fig. 12.8. For procedure  $g$ , we create a clone to represent all instances of  $g$  that are first called from sites  $c1$ ,  $c2$ , and  $c3$ . In this case, the analysis would determine that the invocation at call site  $c1$  returns 1, assuming the analysis can deduce that with  $v = 0$ , the test  $v > 1$  fails. This analysis does not handle recursion well enough to produce the constants for call sites  $c2$  and  $c3$ , however. •

### 12.1.5 Summary-Based Context-Sensitive Analysis

Summary-based interprocedural analysis is an extension of region-based analysis. Basically, in a summary-based analysis each procedure is represented by a concise description ("summary") that encapsulates some observable behavior of the procedure. The primary purpose of the summary is to avoid reanalyzing a procedure's body at every call site that may invoke the procedure. \*

Let us first consider the case where there is no recursion. Each procedure is modeled as a region with a single entry point, with each caller-callee pair sharing

```
    for (i = 0; i < n; i++) {
c1:        t1 = g1(0);
c2:        t2 = g2(243);
c3:        t3 = g3(243);
           x[i] = t1+t2+t3;
    }

    int g1 (int v) {
        if (v > 1) {
c4.1:      return g1(v-1);
        } else {
c5.1:      return f1(v);
        }
    }

    int g2 (int v) {
        if (v > 1) {
c4.2:      return g2(v-1);
        } else {
c5.2:      return f2(v);
        }
    }

    int g3 (int v) {
        if (v > 1) {
c4.3:      return g3(v-1);
        } else {
c5.3:      return f3(v);
        }
    }

    int f1 (int v) {
        return (v+1);
    }
    int f2 (int v) {
        return (v+1);
    }
    int f3 (int v) {
        return (v+1);
    }
}
```

Figure 12.8: Cloned version of Fig. 12.6

an outer-inner region relationship. The only difference from the intraprocedural version is that, in the interprocedural case, a procedure region can be nested inside several different outer regions.

The analysis consists of two parts:

1. A bottom-up phase that computes a transfer function to summarize the effect of a procedure, and
2. A top-down phase that propagates caller information to compute results of the callees.

To get fully context-sensitive results, information from different calling contexts must propagate down to the callees individually. For a more efficient, but less precise calculation, information from all callers can be combined, using a meet operator, then propagated down to the callees.

**Example 12.8 :** For constant propagation, each procedure is summarized by a transfer function specifying how it would propagate constants through its body. In Example 12.2, we can summarize  $f$  as a function that, given a constant  $c$  as an actual parameter to  $v$ , returns the constant  $c+1$ . Based on this information, the analysis would determine that  $t1$ ,  $t2$ , and  $t3$  have the constant values 1, 244, and 244, respectively. Note that this analysis does not suffer the inaccuracy due to unrealizable call strings.

Recall that Example 12.4 extends Example 12.2 by having  $g$  call  $f$ . Thus, we could conclude that the transfer function for  $g$  is the same as the transfer function for  $f$ . Again we conclude that  $t1$ ,  $t2$ , and  $t3$  have the constant values 1, 244, and 244, respectively.

Now, let us consider what is the value of parameter  $v$  in function  $f$  for Example 12.2. As a first cut, we can combine all the results for all calling contexts. Since  $v$  may have values 0 or 243, we can simply conclude that  $v$  is not a constant. This conclusion is fair, because there is no constant that can replace  $v$  in the code.

If we desire more precise results, we can compute specific results for contexts of interest. Information must be passed down from the context of interest to determine the context-sensitive answer. This step is analogous to the top-down pass in region-based analysis. For example, the value of  $v$  is 0 at call site  $c1$  and 243 at sites  $c2$  and  $c3$ . To get the advantage of constant propagation within  $f$ , we need to capture this distinction by creating two clones, with the first specialized for input value 0 and the latter with value 243, as shown in Fig. 12.9. •

With Example 12.8, we see that, in the end, if we wish to compile the code differently in different contexts, we still need to clone the code. The difference is that in the cloning-based approach, cloning is performed prior to the analysis, based on the call strings. In the summary-based approach, the cloning is performed after the analysis, using the analysis results as a basis.



```

        for (i = 0; i < n; i++) {
c1:         t1 = f0(0);
c2:         t2 = f243(243);
c3:         t3 = f243(243);
            X[i] = t1+t2+t3;
        }

int f0 (int v) {
    return (1);
}

int f243 (int v) {
    return (244);
}

```

Figure 12.9: Result of propagating all possible constant arguments to the function /

Even if cloning is not applied, in the summary-based approach inferences about the effect of a called procedure are made accurately, without the problem of unrealizable paths.

Instead of cloning a function, we could also inline the code. Inlining has the additional effect of eliminating the procedure-call overhead as well.

We can handle recursion by computing the fixedpoint solution. In the presence of recursion, we first find the strongly connected components in the call graph. In the bottom-up phase, we do not visit a strongly connected component unless all its successors have been visited. For a nontrivial strongly connected component, we iteratively compute the transfer functions for each procedure in the component until convergence is reached; that is, we iteratively update the transfer functions until no more changes occur.

### 12.1.6 Exercises for Section 12.1

**Exercise 12.1.1:** In Fig. 12.10 is a C program with two function pointers,  $p$  and  $q$ .  $N$  is a constant that could be less than or greater than 10. Note that the program results in an infinite sequence of calls, but that is of no concern for the purposes of this problem.

- a) Identify all the call sites in this program.
- b) For each call site, what can  $p$  point to? What can  $q$  point to?
- c) Draw the call graph for this program.
- ! d) Describe all the call strings for  $f$  and  $g$ .

```

int (*p)(int);
int (*q)(int);

int f(int i) {
    if (i < 10)
        *p = &q; return (*q)(i);}
    else
        *p = &f; return (*p)(i);}
}

int g(int j) {
    if (j < 10)
        {q = &f; return (*p)(j);}
    else
        {q = &g; return (*q)(j);}
}

void main() {
    p = &f;
    q = &g;
    (*p)((*q)(N));
}

```

Figure 12.10: Program for Exercise 12.1.1

Exercise 12.1.2 : In Fig. 12.11 is a function `id` that is the "identity function"; it returns exactly what it is given as an argument. We also see a code fragment consisting of a branch and following assignment that sums  $x + y$ .

- a) Examining the code, what can we tell about the value of  $z$  at the end?
- b) Construct the flow graph for the code fragment, treating the calls to `id` as control flow.
- c) If we run a constant-propagation analysis, as in Section 9.4, on your flow graph from (b), what constant values are determined?
- d) What are all the call sites in Fig. 12.11?
- e) What are all the contexts in which `id` is called?
- f) Rewrite the code of Fig. 12.11 by cloning a new version of `id` for each context in which it is called.
- g) Construct the flow graph of your code from (f), treating the calls as control flow.

```
int id(int x) { return x;}

if (a == 1) { x = id(2); y = id(3); }
else      { x = id(3); y = id(2); }
z = x+y;
```

Figure 12.11: Code fragment for Exercise 12.1.2

- h) Perform a constant-propagation analysis on your flow graph from (g). What constant values are determined now?

## 12.2 Why Interprocedural Analysis?

Given how hard interprocedural analysis is, let us now address the important problem of why and when we wish to use interprocedural analysis. Although we used constant propagation to illustrate interprocedural analysis, this interprocedural optimization is neither readily applicable nor particularly beneficial when it does occur. Most of the benefits of constant propagation can be obtained simply by performing intraprocedural analysis and inlining procedure calls of the most frequently executed sections of code.

However, there are many reasons why interprocedural analysis is essential. Below, we describe several important applications of interprocedural analysis.

### 12.2.1 Virtual Method Invocation

As mentioned above, object-oriented programs have many small methods. If we only optimize one method at a time, then there are few opportunities for optimization. Resolving method invocation enables optimization. A language like Java dynamically loads its classes. As a result, we do not know at compile-time to which of (perhaps) many methods named  $m$  a use of "m" refers in an invocation such as  $x.mQ$ .

Many Java implementations use a just-in-time compiler to compile its byte-codes at run time. One common optimization is to profile the execution and determine which are the common receiver types. We can then inline the methods that are most frequently invoked. The code includes a dynamic check on the type and executes the inlined methods if the run-time object has the expected type.

Another approach to resolving uses of a method name  $m$  is possible as long as all the source code is available at compile time. Then, it is possible to perform an interprocedural analysis to determine the object types. If the type for a variable  $x$  turns out to be unique, then a use of  $x.mQ$  can be resolved.

We know exactly what method `m` refers to in this context. In that case, we can in-line the code for this `m`, and the compiler does not even have to include a test for the type of `x`.

### 12.2.2 Pointer Alias Analysis

Even if we do not wish to perform interprocedural versions of the common data-flow analyses like reaching definitions, these analyses can in fact benefit from interprocedural pointer analysis. All the analyses presented in Chapter 9 apply only to local scalar variables that cannot have aliases. However, use of pointers is common, especially in languages like C. By knowing whether pointers can be *aliases* (can point to the same location), we can improve the accuracy of the techniques from Chapter 9.

Example 12.9: Consider the following sequence of three statements, which might form a basic block:

```
*p = i;  
*q = 2;  
x = *p;
```

Without knowing if `p` and `q` can point to the same location — that is, whether they can be aliases — we cannot conclude that `x` is equal to 1 at the end of the block. •

### 12.2.3 Parallelization

As discussed in Chapter 11, the most effective way to parallelize an application is to find the coarsest granularity of parallelism, such as that found in the outermost loops of a program. For this task, interprocedural analysis is of great importance. There is a significant difference between *scalar* optimizations (those based on values of simple variables, as discussed in Chapter 9) and parallelization. In parallelization, just one spurious data dependence can render an entire loop not parallelizable, and greatly reduce the effectiveness of the optimization. Such amplification of inaccuracies is not seen in scalar optimizations. In scalar optimization, we only need to find the majority of the optimization opportunities. Missing one opportunity or two seldom makes much of a difference.

### 12.2.4 Detection of Software Errors and Vulnerabilities

Interprocedural analysis is not only important for optimizing code. The same techniques can be used to analyze existing software for many kinds of coding errors. These errors can render software unreliable; coding errors that hackers can exploit to take control of, or otherwise damage, a computer system can pose significant security vulnerability risks.

Static analysis is useful in detecting occurrences of many common error patterns. For example, a data item must be guarded by a lock. As another example, disabling an interrupt in the operating system must be followed by a re-enabling of the interrupt. Since a significant source of errors is the inconsistencies that span procedure boundaries, interprocedural analysis is of great importance. PREFIX and METAL are two practical tools that use interprocedural analysis effectively to find many programming errors in large programs. Such tools find errors statically and can improve software reliability greatly. However, these tools are both incomplete and unsound, in the sense that they may not find all errors, and not all reported warnings are real errors. Unfortunately, the interprocedural analysis used is sufficiently imprecise that, were the tools to report all potential errors, the large number of false warnings would render the tools unusable. Nevertheless, even though these tools are not perfect, their systematic use has been shown to greatly improve software reliability.

When it comes to security vulnerabilities, it is highly desirable that we find all the potential errors in a program. In 2006, two of the "most popular" forms of intrusions used by hackers to compromise a system were

1. Lack of input validation on Web applications: SQL injection is one of the most popular forms of such vulnerability whereby hackers gain control of a database by manipulating inputs accepted by web applications.
2. Buffer overflows in C and C++ programs. Because C and C++ do not check if accesses to arrays are in bounds, hackers can write well-crafted strings into unintended areas and hence gain control of the program's execution.

In the next section, we shall discuss how we can use interprocedural analysis to protect programs against such vulnerabilities.

### 12.2.5 SQL Injection

SQL injection refers to the vulnerability where hackers can manipulate user input to a Web application and gain unintended access to a database. For example, banks want their users to be able to make transactions online, provided they supply their correct password. A common architecture for such a system is to have the user enter strings into a Web form, and then to have those strings form part of a database query written in the SQL language. If systems developers are not careful, the strings provided by the user can alter the meaning of the SQL statement in unexpected ways.

Example 12.10: Suppose a bank offers its customers access to a relation

```
AcctData(name, password, balance)
```

That is, this relation is a table of triples, each consisting of the name of a customer, the password, and the balance of the account. The intent is that customers can see their account balance only if they provide both their name and

their correct password. Having a hacker see an account balance is not the worst thing that could occur, but this simple example is typical of more complicated situations where the hacker could execute payments from the account.

The system might implement a balance inquiry as follows:

1. Users invoke a Web form where they enter their name and password.
2. The name is copied to a variable  $n$  and the password to a variable  $p$ .
3. Later, perhaps in some other procedure, the following SQL query is executed:

```
SELECT balance FROM AcctData
WHERE name = ':n' and password = ':p'
```

For readers not familiar with SQL, this query says: "Find in the table AcctData a row with the first component (name) equal to the string currently in variable  $n$  and the second component (password) equal to the string currently in variable  $p$ ; print the third component (balance) of that row." Note that SQL uses single quotes, not double quotes, to delimit strings, and the colons in front of  $n$  and  $p$  indicate that they are variables of the surrounding language.

Suppose the hacker, who wants to find Charles Dickens' account balance, supplies the following values for the strings  $n$  and  $p$ :

$n = \text{Charles Dickens}' \text{ — } p = \text{who cares}$

The effect of these strange strings is to convert the query into

```
SELECT balance FROM AcctData
WHERE name = 'Charles Dickens' —' and password = 'who cares'
```

In many database systems — is a comment-introducing token and has the effect of making whatever follows on that line a comment. As a result, the query now asks the database system to print the balance for every person whose name is 'Charles Dickens', regardless of the password that appears with that name in a name-password-balance triple. That is, with comments eliminated, the query is:

```
SELECT balance FROM AcctData
WHERE name = 'Charles Dickens'
```

•

In Example 12.10, the "bad" strings were kept in two variables, which might be passed between procedures. However, in more realistic cases, these strings might be copied several times, or combined with others to form the full query. We cannot hope to detect coding errors that create SQL-injection vulnerabilities without doing a full interprocedural analysis of the entire program.

### 12.2.6 Buffer Overflow

A *buffer overflow attack* occurs when carefully crafted data supplied by the user writes beyond the intended buffer and manipulates the program execution. For example, a C program may read a string  $s$  from the user, and then copy it into a buffer  $b$  using the function call:

```
strcpy(b,s);
```

If the string  $s$  is actually longer than the buffer  $b$ , then locations that are not part of  $b$  will have their values changed. That in itself will probably cause the program to malfunction or at least to produce the wrong answer, since some data used by the program will have been changed.

But worse, the hacker who chose the string  $s$  can pick a value that will do more than cause an error. For example, if the buffer is on the run-time stack, then it is near the return address for its function. An insidiously chosen value of  $s$  may overwrite the return address, and when the function returns, it goes to a place chosen by the hacker. If hackers have detailed knowledge of the surrounding operating system and hardware, they may be able to execute a command that will give them control of the machine itself. In some situations, they may even have the ability to have the false return address transfer control to code that is part of the string  $s$ , thus allowing any sort of program to be inserted into the executing code.

To prevent buffer overflows, every array-write operation must be statically proven to be within bounds, or a proper array-bounds check must be performed dynamically. Because these bounds checks need to be inserted by hand in C and C++ programs, it is easy to forget to insert the test or to get the test wrong. Heuristic tools have been developed that will check if at least some test, though not necessarily a correct test, has been performed before a `strcpy` is called.

Dynamic bounds checking is unavoidable because it is impossible to determine statically the size of users' input. All a static analysis can do is assure that the dynamic checks have been inserted properly. Thus, a reasonable strategy is to have the compiler insert dynamic bounds checking on every write, and use static analysis as a means to optimize away as many bounds check as possible. It is no longer necessary to catch every potential violation; moreover, we only need to optimize only those code regions that execute frequently.

Inserting bounds checking into C programs is nontrivial, even if we do not mind the cost. A pointer may point into the middle of some array, and we do not know the extent of that array. Techniques have been developed to keep track of the extent of the buffer pointed to by each pointer dynamically. This information allows the compiler to insert array bounds checks for all accesses. Interestingly enough, it is not advisable to halt a program whenever a buffer overflow is detected. In fact, buffer overflows do occur in practice, and a program would likely fail if we disable all buffer overflows. The solution is to extend the size of the array dynamically to accommodate for the buffer overruns.

Interprocedural analysis can be used to speed up the cost of dynamic array bounds checks. For example, suppose we are interested only in catching buffer overflows involving user-input strings, we can use static analysis to determine which variables may hold contents provided by the user. Like SQL injection, being able to track an input as it is copied across procedures is useful in eliminating unnecessary bounds checks.

## 12.3 A Logical Representation of Data Flow

To this point, our representation of data-flow problems and solutions can be termed "set-theoretic." That is, we represent information as sets and compute results using operators like union and intersection. For instance, when we introduced the reaching-definitions problem in Section 9.2.4, we computed  $IN[B]$  and  $OUT[J3]$  for a block  $B$ , and we described these as sets of definitions. We represented the contents of the block  $B$  by its gen and kill sets.

To cope with the complexity of interprocedural analysis, we now introduce a more general and succinct notation based on logic. Instead of saying something like "definition  $D$  is in  $IN[\#?]$ ," we shall use a notation like  $in(B,D)$  to mean the same thing. Doing so allows us to express succinct "rules" about inferring program facts. It also allows us to implement these rules efficiently, in a way that generalizes the bit-vector approach to set-theoretic operations. Finally, the logical approach allows us to combine what appear to be several independent analyses into one, integrated algorithm. For example, in Section 9.5 we described partial-redundancy elimination by a sequence of four data-flow analyses and two other intermediate steps. In the logical notation, all these steps could be combined into one collection of logical rules that are solved simultaneously.

### 12.3.1 Introduction to Datalog

Datalog is a language that uses a Prolog-like notation, but whose semantics is far simpler than that of Prolog. To begin, the elements of Datalog are *atoms* of the form  $p(X_1, X_2, \dots, X_n)$ . Here,

1.  $p$  is a *predicate* — a symbol that represents a type of statement such as "a definition reaches the beginning of a block."
2.  $X_1, X_2, \dots, X_n$  are terms such as variables or constants. We shall also allow simple expressions as arguments of a predicate.<sup>2</sup>

A *ground atom* is a predicate with only constants as arguments. Every ground atom asserts a particular fact, and its value is either true or false. It

<sup>2</sup>Formally, such terms are built from function symbols and complicate the implementation of Datalog considerably. However, we shall use only a few operators, such as addition or subtraction of constants, in contexts that do not complicate matters.



is often convenient to represent a predicate by a *relation*, or table of its true ground atoms. Each ground atom is represented by a single row, or *tuple*, of the relation. The columns of the relation are named by *attributes*, and each tuple has a component for each attribute. The attributes correspond to the components of the ground atoms represented by the relation. Any ground atom in the relation is true, and ground atoms not in the relation are false.

Example 12.11: Let us suppose the predicate  $in(B,D)$  means "definition  $D$  reaches the beginning of block  $BP$ ". Then we might suppose that, for a particular flow graph,  $in(b_1,d_1)$  is true, as are  $in(b_2,d_1)$  and  $in(b_2,d_2)$ . We might also suppose that for this flow graph, all other  $in$  facts are false. Then the relation in Fig. 12.12 represents the value of this predicate for this flow graph.

$B$	$D$
$h$	$d_1$
	$d_1$
$b_2$	$d_2$

Figure 12.12: Representing the value of a predicate by a relation

The attributes of the relation are  $B$  and  $D$ . The three tuples of the relation are  $(h,d_1)$ ,  $(b_2,d_1)$ , and  $(b_2,d_2)$ .

We shall also see at times an atom that is really a comparison between variables and constants. An example would be  $X \wedge Y$  or  $X = 10$ . In these examples, the predicate is really the comparison operator. That is, we can think of  $X = 10$  as if it were written in predicate form:  $equals(X, 10)$ . There is an important difference between comparison predicates and others, however. A comparison predicate has its standard interpretation, while an ordinary predicate like  $in$  means only what it is defined to mean by a Datalog program (described next).

A *literal* is either an atom or a negated atom. We indicate negation with the word **NOT** in front of the atom. Thus, **NOT**  $in(B,D)$  is an assertion that definition  $D$  does not reach the beginning of block  $B$ .

### 12.3.2 Datalog Rules

Rules are a way of expressing logical inferences. In Datalog, rules also serve to suggest how a computation of the true facts should be carried out. The form of a rule is

$$H : - B_1 \wedge B_2 \wedge \dots \wedge B_n$$

The components are as follows:

- $H$  and  $B_1, B_2, \dots, B_n$  are literals — either atoms or negated atoms.

## Datalog Conventions

We shall use the following conventions for Datalog programs:

1. Variables begin with a capital letter.
2. All other elements begin with lowercase letters or other symbols such as digits. These elements include predicates and constants that are arguments of predicates.

- $H$  is the *head* and  $B_1, B_2, \dots, B_n$  form the *body* of the rule.
- Each of the  $B_i$ 's is sometimes called a *subgoal* of the rule.

We should read the  $:-$  symbol as "if." The meaning of a rule is "the head is true if the body is true." More precisely, we *apply* a rule to a given set of ground atoms as follows. Consider all possible substitutions of constants for the variables of the rule. If this substitution makes every subgoal of the body true (assuming that all and only the given ground atoms are true), then we can infer that the head with this substitution of constants for variables is a true fact. Substitutions that do not make all subgoals true give us no information; the head may or may not be true.

A *Datalog program* is a collection of rules. This program is applied to "data," that is, to a set of ground atoms for some of the predicates. The result of the program is the set of ground atoms inferred by applying the rules until no more inferences can be made.

Example 12.12: A simple example of a Datalog program is the computation of paths in a graph, given its (directed) edges. That is, there is one predicate  $edge(X, Y)$  that means "there is an edge from node  $X$  to node  $Y$ ." Another predicate  $path(X, Y)$  means that there is a path from  $X$  to  $Y$ . The rules defining paths are:

- 1)  $path(X, Y) \quad :- \quad edge(X, Y)$
- 2)  $path(X, Y) \quad :- \quad path(X, Z) \wedge path(Z, Y)$

The first rule says that a single edge is a path. That is, whenever we replace variable  $X$  by a constant  $a$  and variable  $Y$  by a constant  $b$ , and  $edge(a, b)$  is true (i.e., there is an edge from node  $a$  to node  $b$ ), then  $path(a, b)$  is also true (i.e., there is a path from  $a$  to  $b$ ). The second rule says that if there is a path from some node  $X$  to some node  $Z$ , and there is also a path from  $Z$  to node  $Y$ , then there is a path from  $X$  to  $Y$ . This rule expresses "transitive closure." Note that any path can be formed by taking the edges along the path and applying the transitive closure rule repeatedly.

For instance, suppose that the following facts (ground atoms) are true:  $edge(1,2)$ ,  $edge(2,3)$ , and  $edge(3,4)$ . Then we can use the first rule with three different substitutions to infer  $path(1,2)$ ,  $path(2,3)$ , and  $path(3,4)$ . As an example, substituting  $X = 1$  and  $Y = 2$  instantiates the first rule to be  $path(1,2) : - edge(1,2)$ . Since  $edge(1,2)$  is true, we infer  $path(1,2)$ .

With these three *path* facts, we can use the second rule several times. If we substitute  $X = 1$ ,  $Z = 2$ , and  $Y = 3$ , we instantiate the rule to be  $path(1,3) : - path(1,2) \ \& \ path(2,3)$ . Since both subgoals of the body have been inferred, they are known to be true, so we may infer the head:  $path(1,3)$ . Then, the substitution  $X = 1$ ,  $Z = 3$ , and  $Y = 4$  lets us infer the head  $path(1,4)$ ; that is, there is a path from node 1 to node 4. •

### 12.3.3 Intensional and Extensional Predicates

It is conventional in Datalog programs to distinguish predicates as follows:

1. EDB, or *extensional database*, predicates are those that are defined a priori. That is, their true facts are either given in a relation or table, or they are given by the meaning of the predicate (as would be the case for a comparison predicate, e.g.).
2. IDB, or *intensional database*, predicates are defined only by the rules.

A predicate must be IDB or EDB, and it can be only one of these. As a result, any predicate that appears in the head of one or more rules must be an IDB predicate. Predicates appearing in the body can be either IDB or EDB. For instance, in Example 12.12, *edge* is an EDB predicate and *path* is an IDB predicate. Recall that we were given some *edge* facts, such as  $edge(1,2)$ , but the *path* facts were inferred by the rules.

When Datalog programs are used to express data-flow algorithms, the EDB predicates are computed from the flow graph itself. IDB predicates are then expressed by rules, and the data-flow problem is solved by inferring all possible IDB facts from the rules and the given EDB facts.

Example 12.13 : Let us consider how reaching definitions might be expressed in Datalog. First, it makes sense to think on a statement level, rather than a block level; that is, the construction of gen and kill sets from a basic block will be integrated with the computation of the reaching definitions themselves. Thus, the block  $b \setminus$  suggested in Fig. 12.13 is typical. Notice that we identify points within the block numbered  $0, 1, \dots, n$ , if  $n$  is the number of statements in the block. The  $i$ th definition is "at" point  $i$ , and there is no definition at point 0.

A point in the program must be represented by a pair  $(b,n)$ , where  $b$  is a block name and  $n$  is an integer between 0 and the number of statements in block  $b$ . Our formulation requires two EDB predicates:

```

0  x = y+z
   *p = u
2  x = v
3

```

Figure 12.13: A basic block with points between statements

1.  $def(B, N, X)$  is true if and only if the  $i$ Vth statement in block  $B$  may define variable  $X$ . For instance, in Fig. 12.13  $def(b_i, l, x)$  is true,  $def(b_i, S, x)$  is true, and  $def(b_i, 2, Y)$  is true for every possible variable  $Y$  that  $p$  may point to at that point. For the moment, we shall assume that  $Y$  can be any variable of the type that  $p$  points to.
2.  $succ(B, N, C)$  is true if and only if block  $C$  is a successor of block  $B$  in the flow graph, and  $B$  has  $N$  statements. That is, control can flow from the point  $N$  of  $B$  to the point 0 of  $C$ . For instance, suppose that  $b_i$  is a predecessor of block  $b_j$  in Fig. 12.13, and  $b_j$  has 5 statements. Then  $succ(b_i, 5, \&i)$  is true.

There is one IDB predicate,  $rd(B, N, C, M, X)$ . It is intended to be true if and only if the definition of variable  $X$  at the  $M$ th statement of block  $C$  reaches the point  $N$  in block  $B$ . The rules defining predicate  $rd$  are in Fig. 12.14.

- 1)  $rd(B, N, B, N, X) \quad :- \quad def(B, N, X)$
- 2)  $rd(B, N, C, M, X) \quad :- \quad rd(B, N - 1, C, M, X) \quad k$   
 $def(B, A, Y) \quad k$   
 $X \text{ j+ } Y$
- 3)  $rd(B, 0, C, M, X) \quad :- \quad rd(D, N, C, M, X) \quad k$   
 $succ(D, N, B)$

Figure 12.14: Rules for predicate  $rd$ 

Rule (1) says that if the  $N$ th statement of block  $B$  defines  $X$ , then that definition of  $X$  reaches the  $N$ th point of  $B$  (i.e., the point immediately after the statement). This rule corresponds to the concept of "gen" in our earlier, set-theoretic formulation of reaching definitions.

Rule (2) represents the idea that a definition passes through a statement unless it is "killed," and the only way to kill a definition is to redefine its variable with 100% certainty. In detail, rule (2) says that the definition of variable  $X$  from the  $M$ th statement of block  $C$  reaches the point  $N$  of block  $B$  if

- a) it reaches the previous point  $N - 1$  of  $B$ , and

- b) there is at least one variable  $Y$ , other than  $X$ , that may be defined at the  $TV$ th statement of  $B$ .

Finally, rule (3) expresses the flow of control in the graph. It says that the definition of  $X$  at the  $M$ th statement of block  $C$  reaches the point 0 of  $B$  if there is some block  $D$  with  $TV$  statements, such that the definition of  $X$  reaches the end of  $D$ , and  $B$  is a successor of  $D$ . •

The EDB predicate *succ* from Example 12.13 clearly can be read off the flow graph. We can obtain *def* from the flow graph as well, if we are conservative and assume a pointer can point anywhere. If we want to limit the range of a pointer to variables of the appropriate type, then we can obtain type information from the symbol table, and use a smaller relation *def*. An option is to make *def* an IDB predicate and define it by rules. These rules will use more primitive EDB predicates, which can themselves be determined from the flow graph and symbol table.

Example 12.14: Suppose we introduce two new EDB predicates:

1. *assign*( $B, N, X$ ) is true whenever the  $iV$ th statement of block  $B$  has  $X$  on the left. Note that  $X$  can be a variable or a simple expression with an l-value, like  $*p$ .
2. *type*( $X, T$ ) is true if the type of  $X$  is  $T$ . Again,  $X$  can be any expression with an l-value, and  $T$  can be any expression for a legal type.

Then, we can write rules for *def*, making it an IDB predicate. Figure 12.15 is an expansion of Fig. 12.14, with two of the possible rules for *def*. Rule (4) says that the  $TV$ th statement of block  $B$  defines  $X$ , if  $X$  is assigned by the  $TV$ th statement. Rule (5) says that  $X$  can also be defined by the  $iV$ th statement of block  $B$  if that statement assigns to  $*P$ , and  $X$  is any of the variables of the type that  $P$  points to. Other kinds of assignments would need other rules for *def*.

As an example of how we would make inferences using the rules of Fig. 12.15, let us re-examine the block  $bi$  of Fig. 12.13. The first statement assigns a value to variable  $x$ , so the fact *assign*( $bi, 1, x$ ) would be in the EDB. The third statement also assigns to  $x$ , so *assign*( $bi, 3, x$ ) is another EDB fact. The second statement assigns indirectly through  $p$ , so a third EDB fact is *assign*( $bi, 2, *p$ ). Rule (4) then allows us to infer *def*( $bi, 1, x$ ) and *def*( $bi, 3, x$ ).

Suppose that  $p$  is of type pointer-to-integer ( $*int$ ), and  $x$  and  $y$  are integers. Then we may use rule (5), with  $B = h$ ,  $N = 2$ ,  $P = p$ ,  $T = int$ , and  $X$  equal to either  $x$  or  $y$ , to infer *def*( $h, 2, x$ ) and *def*( $h, 2, y$ ). Similarly, we can infer the same about any other variable whose type is integer or coerceable to an integer. •

- 1)  $rd(B,N,B,N,X) \quad :- \quad def(B,N,X)$
- 2)  $rd(B,N,C,M,X) \quad :- \quad rd(B, N - 1, C, M, X) \ \& \ def(B,N,Y)k$
- 3)  $rd(\pounds, 0, C, M, X) \quad :- \quad rd(D, iV, C, M, X) \ \& \ succ(D,N,B)$
- 4)  $def(B,N,X) \quad :- \quad assign(B,N,X)$
- 5)  $def(B,N,X) \quad :- \quad assign(B, N, *P) \ \& \ *ype(X,T) \ \& \ type(P,*T)$

Figure 12.15: Rules for predicates  $rd$  and  $def$ 

### 12.3.4 Execution of Datalog Programs

Every set of Datalog rules defines relations for its IDB predicates, as a function of the relations that are given for its EDB predicates. Start with the assumption that the IDB relations are empty (i.e., the IDB predicates are false for all possible arguments). Then, repeatedly apply the rules, inferring new facts whenever the rules require us to do so. When the process converges, we are done, and the resulting IDB relations form the output of the program. This process is formalized in the next algorithm, which is similar to the iterative algorithms discussed in Chapter 9.

Algorithm 12.15: Simple evaluation of Datalog programs.

**INPUT:** A Datalog program and sets of facts for each EDB predicate.

**OUTPUT:** Sets of facts for each IDB predicate.

**METHOD:** For each predicate  $p$  in the program, let  $R_p$  be the relation of facts that are true for that predicate. If  $p$  is an EDB predicate, then  $R_p$  is the set of facts given for that predicate. If  $p$  is an IDB predicate, we shall compute  $R_p$ . Execute the algorithm in Fig. 12.16. •

Example 12.16: The program in Example 12.12 computes paths in a graph. To apply Algorithm 12.15, we start with EDB predicate  $edge$  holding all the edges of the graph and with the relation for  $path$  empty. On the first round, rule (2) yields nothing, since there are no  $path$  facts. But rule (1) causes all the  $edge$  facts to become  $path$  facts as well. That is, after the first round, we know  $path(a, 6)$  if and only if there is an edge from  $a$  to  $6$ .

```

for (each IDB predicate  $p$ )
   $R_p = \emptyset$ ;
while (changes to any  $R_p$  occur) {
  consider all possible substitutions of constants for
  variables in all the rules;
  determine, for each substitution, whether all the
  subgoals of the body are true, using the current
   $R_p$ 's to determine truth of EDB and IDB predicates;
  if (a substitution makes the body of a rule true)
    add the head to  $R_p$  if  $q$  is the head predicate;
}

```

Figure 12.16: Evaluation of Datalog programs

On the second round, rule (1) yields no new paths facts, because the EDB relation *edge* never changes. However, now rule (2) lets us put together two paths of length 1 to make paths of length 2. That is, after the second round,  $path(a, b)$  is true if and only if there is a path of length 1 or 2 from  $a$  to  $b$ . Similarly, on the third round, we can combine paths of length 2 or less to discover all paths of length 4 or less. On the fourth round, we discover paths of length up to 8, and in general, after the  $i$ th round,  $path(a, b)$  is true if and only if there is a path from  $a$  to  $b$  of length  $2^i$  or less. •

### 12.3.5 Incremental Evaluation of Datalog Programs

There is an efficiency enhancement of Algorithm 12.15 possible. Observe that a new IDB fact can only be discovered on round  $i$  if it is the result of substituting constants in a rule, such that at least one of the subgoals becomes a fact that was just discovered on round  $i - 1$ . The proof of that claim is that if all the facts among the subgoals were known at round  $i - 2$ , then the "new" fact would have been discovered when we made the same substitution of constants on round  $i - 1$ .

To take advantage of this observation, introduce for each IDB predicate  $p$  a predicate  $newP$  that will hold only the newly discovered p-facts from the previous round. Each rule that has **One** or more IDB predicates among its subgoals is replaced by a collection of rules. Each rule in the collection is formed by replacing exactly one occurrence of some IDB predicate  $q$  in the body by  $newQ$ . Finally, for all rules, we replace the head predicate  $h$  by  $newH$ . The resulting rules are said to be in *incremental form*.

The relations for each IDB predicate  $p$  accumulates all the p-facts, as in Algorithm 12.15. In one round, we

1. Apply the rules to evaluate the  $newP$  predicates.

### Incremental Evaluation of Sets

It is also possible to solve set-theoretic data-flow problems incrementally. For example, in reaching definitions, a definition can only be newly discovered to be in  $m[B]$  on the 2th round if it was just discovered to be in **OUT**[P] for some predecessor  $P$  of  $B$ . The reason we do not generally try to solve such data-flow problems incrementally is that the bit-vector implementation of sets is so efficient. It is generally easier to fly through the complete vectors than to decide whether a fact is new or not.

2. Then, subtract  $p$  from  $newP$ , to make sure the facts in  $newP$  are truly new.
3. Add the facts in  $newP$  to  $p$ .
4. Set all the  $newX$  relations to 0 for the next round.

These ideas will be formalized in Algorithm 12.18. However, first, we shall give an example.

Example 12.17: Consider the Datalog program in Example 12.12 again. The incremental form of the rules is given in Fig. 12.17. Rule (1) does not change, except in the head because it has no IDB subgoals in the body. However, rule (2), with two IDB subgoals, becomes two different rules. In each rule, one of the occurrences  $opath$  in the body is replaced by  $newPath$ . Together, these rules enforce the idea that at least one of the two paths concatenated by the rule must have been discovered on the previous round. •

$$\begin{array}{ll}
 1) & newPath(X,Y) \quad :- \quad edge(X,Y) \\
 2a) & newPath(X, Y) \quad :- \quad path(X, Z) \ \& \\
 & \quad \quad \quad \quad \quad \quad newPath(Z, \quad Y) \\
 2b) & newPath(X, Y) \quad :- \quad newPath(X, Z) \ k \\
 & \quad \quad \quad \quad \quad \quad path(Z, \quad Y)
 \end{array}$$

Figure 12.17: Incremental rules for the path Datalog program

Algorithm 12.18: Incremental evaluation of Datalog programs.

**INPUT:** A Datalog program and sets of facts for each EDB predicate.

**OUTPUT:** Sets of facts for each IDB predicate.



**METHOD:** For each predicate  $p$  in the program, let  $R_p$  be the relation of facts that are true for that predicate. If  $p$  is an EDB predicate, then  $R_p$  is the set of facts given for that predicate. If  $p$  is an IDB predicate, we shall compute  $R_p$ . In addition, for each IDB predicate  $p$ , let  $R_{new}p$  be a relation of "new" facts for predicate  $p$ .

1. Modify the rules into the incremental form described above.
2. Execute the algorithm in Fig. 12.18.

•

```

for (each IDB predicate  $p$ ) {
     $R_p = \emptyset$ ;
     $R_{new}p = 0$ ;
}
repeat {
    consider all possible substitutions of constants for
        variables in all the rules;
    determine, for each substitution, whether all the
        subgoals of the body are true, using the current
         $R_p$ 's and  $R_{new}p$ 's to determine truth of EDB
        and IDB predicates;
    if (a substitution makes the body of a rule true)
        add the head to  $R_{new}p$ , where  $h$  is the head
        predicate;
    for (each predicate  $p$ ) {
         $R_{new}p = R_{new}p \cup R_p$ ;
         $R_p = R_p \cup R_{new}p$ ;
    }
} until (all  $R_{new}p$ 's are empty);

```

Figure 12.18: Evaluation of Datalog programs

### 12.3.6 Problematic Datalog Rules

There are certain Datalog rules or programs that technically have no meaning and should not be used. The two most important risks are

1. *Unsafe rules*: those that have a variable in the head that does not appear in the body in a way that constrains that variable to take on only values that appear in the EDB.
2. *Unstratified programs*: sets of rules that have a recursion involving a negation.

We shall elaborate on each of these risks.

## Rule Safety

Any variable that appears in the head of a rule must also appear in the body. Moreover, that appearance must be in a subgoal that is an ordinary IDB or EDB atom. It is not acceptable if the variable appears only in a negated atom, or only in a comparison operator. The reason for this policy is to avoid rules that let us infer an infinite number of facts.

Example 12.19: The rule

$$p(X,Y) \text{ :- } q(Z) \ \& \ \mathbf{NOT} \ r(X) \ kX^Y$$

is unsafe for two reasons. Variable  $X$  appears only in the negated subgoal  $r(X)$  and the comparison  $X / Y$ .  $Y$  appears only in the comparison. The consequence is that  $p$  is true for an infinite number of pairs  $(X, Y)$ , as long as  $r(X)$  is false and  $Y$  is anything other than  $X$ . •

## Stratified Datalog

In order for a program to make sense, recursion and negation must be separated. The formal requirement is as follows. We must be able to divide the IDB predicates into *strata*, so that if there is a rule with head predicate  $p$  and a subgoal of the form  $\mathbf{NOT} \#(\bullet\bullet\bullet)$ , then  $q$  is either EDB or an IDB predicate in a lower stratum than  $p$ . As long as this rule is satisfied, we can evaluate the strata, lowest first, by Algorithm 12.15 or 12.18, and then treat the relations for the IDB predicates of that strata as if they were EDB for the computation of higher strata. However, if we violate this rule, then the iterative algorithm may fail to converge, as the next example shows.

Example 12.20 : Consider the Datalog program consisting of the one rule:

$$p(X) \text{ :- } e(X) \ \& \ \mathbf{NOT} p(X)$$

Suppose  $e$  is an EDB predicate, and only  $e(1)$  is true. Is  $p(1)$  true?

This program is not stratified. Whatever stratum we put  $p$  in, its rule has a subgoal that is negated and has an IDB predicate (namely  $p$  itself) that is surely not in a lower stratum than  $p$ .

If we apply the iterative algorithm, we start with  $R_p = 0$ , so initially, the answer is "no;  $p(1)$  is not true." However, the first iteration lets us infer  $p(1)$ , since both  $e(1)$  and  $\mathbf{NOT} p(1)$  are true. But then the second iteration tells us  $p(1)$  is false. That is, substituting  $\mathbf{1}$  for  $X$  in the rule does not allow us to infer  $p(1)$ , since subgoal  $\mathbf{NOT} p(1)$  is false. Similarly, the third iteration says  $p(1)$  is true, the fourth says it is false, and so on. We conclude that this unstratified program is meaningless, and do not consider it a valid program. •

### 12.3.7 Exercises for Section 12.3

**! Exercise 12.3.1:** In this problem, we shall consider a reaching-definitions data-flow analysis that is simpler than that in Example 12.13. Assume that each statement by itself is a block, and initially assume that each statement defines exactly one variable. The EDB predicate  $pred(I, J)$  means that statement  $I$  is a predecessor of statement  $J$ . The EDB predicate  $defines(I, X)$  means that the variable defined by statement  $I$  is  $X$ . We shall use IDB predicates  $in(I, D)$  and  $out(I, D)$  to mean that definition  $D$  reaches the beginning or end of statement  $I$ , respectively. Note that a definition is really a statement number. Fig. 12.19 is a datalog program that expresses the usual algorithm for computing reaching definitions.

```

1)   $kill(I, D) \quad :- \quad defines(I, X) \ k \ defines(D, X)$ 

2)   $out(I, I) \quad :- \quad defines(I, X)$ 
3)   $out(I, D) \quad :- \quad in(I, D) \ k \ \mathbf{NOT} \ kill(I, D)$ 

4)   $in(I, D) \quad :- \quad out(J, D) \ k \ pred(J, I)$ 

```

Figure 12.19: Datalog program for a simple reaching-definitions analysis

Notice that rule (1) says that a statement kills itself, but rule (2) assures that a statement is in its own "out set" anyway. Rule (3) is the normal transfer function, and rule (4) allows confluence, since  $I$  can have several predecessors.

Your problem is to modify the rules to handle the common case where a definition is ambiguous, e.g., an assignment through a pointer. In this situation,  $defines(I, X)$  may be true for several different  $X$ 's and one  $I$ . A definition is best represented by a pair  $(D, X)$ , where  $D$  is a statement, and  $X$  is one of the variables that may be defined at  $D$ . As a result,  $in$  and  $out$  become three-argument predicates; e.g.,  $in(I, D, X)$  means that the (possible) definition of  $X$  at statement  $D$  reaches the beginning of statement  $I$ .

**Exercise 12.3.2:** Write a Datalog program analogous to Fig. 12.19 to compute available expressions. In addition to predicate  $defines$ , use a predicate  $eval(I, X, O, Y)$  that says statement  $I$  causes expression  $XOY$  to be evaluated. Here,  $O$  is the operator in the expression, e.g.,  $+$ .

**Exercise 12.3.3:** Write a Datalog program analogous to Fig. 12.19 to compute live variables. In addition to predicate  $defines$ , assume a predicate  $use(I, X)$  that says statement  $I$  uses variable  $X$ .

**Exercise 12.3.4:** In Section 9.5, we defined a data-flow calculation that involved six concepts: anticipated, available, earliest, postponable, latest, and used. Suppose we had written a Datalog program to define each of these in

terms of EDB concepts derivable from the program (e.g., gen and kill information) and others of these six concepts. Which of the six depend on which others? Which of these dependences are negated? Would the resulting Datalog program be stratified?

**Exercise 12.3.5 :** Suppose that the EDB predicate  $edge(X,Y)$  consists of the following facts:

$$\begin{array}{lll} edge\{1,2\} & edge\{2,3\} & edge\{2>,4\} \\ edge\{4,1\} & edge\{4,5\} & edge\{5,6\} \end{array}$$

- Simulate the Datalog program of Example 12.12 on this data, using the simple evaluation strategy of Algorithm 12.15. Show the *path* facts discovered at each round.
- Simulate the Datalog program of Fig. 12.17 on this data, as part of the incremental evaluation strategy of Algorithm 12.18. Show the *path* facts discovered at each round.

**Exercise 12.3.6 :** The following rule

$$p(X, Y) \text{ :- } q(X, Z) \text{ k } r(Z, W) \text{ k } \text{NOT } p(W, Y)$$

is part of a larger Datalog program  $P$ .

- Identify the head, body, and subgoals of this rule.
- Which predicates are certainly IDB predicates of program  $PI$ ?
- ! Which predicates are certainly EDB predicates of  $P$ ?
- Is the rule safe?
- Is  $P$  stratified?

**Exercise 12.3.7:** Convert the rules of Fig. 12.14 to incremental form.

## 12.4 A Simple Pointer-Analysis Algorithm

In this section, we begin the discussion of a very simple flow-insensitive pointer-alias analysis assuming that there are no procedure calls. We shall show in subsequent sections how to handle procedures first context insensitively, then context sensitively. Flow sensitivity adds a lot of complexity, and is less important to context sensitivity for languages like Java where methods tend to be small.

The fundamental question that we wish to ask in pointer-alias analysis is whether a given pair of pointers may be aliased. One way to answer this question is to compute for each pointer the answer to the question "what objects can this pointer point to?" If two pointers can point to the same object, then the pointers may be aliased.

### 12A.1 Why is Pointer Analysis Difficult

Pointer-alias analysis for C programs is particularly difficult, because C programs can perform arbitrary computations on pointers. In fact, one can read in an integer and assign it to a pointer, which would render this pointer a potential alias of all other pointer variables in the program. Pointers in Java, known as references, are much simpler. No arithmetic is allowed, and pointers can only point to the beginning of an object.

Pointer-alias analysis must be interprocedural. Without interprocedural analysis, one must assume that any method called can change the contents of all accessible pointer variables, thus rendering any intraprocedural pointer-alias analysis ineffective.

Languages allowing indirect function calls present an additional challenge for pointer-alias analysis. In C, one can call a function indirectly by calling a dereferenced function pointer. We need to know what the function pointer can point to before we can analyze the function called. And clearly, after analyzing the function called, one may discover more functions that the function pointer can point to, and therefore the process needs to be iterated.

While most functions are called directly in C, virtual methods in Java cause many invocations to be indirect. Given an invocation  $x.m()$  in a Java program, there may be many classes to which object  $x$  might belong and that have a method named  $m$ . The more precise our knowledge of the actual type of  $x$ , the more precise our call graph is. Ideally, we can determine at compile time the exact class of  $x$  and thus know exactly which method  $m$  refers to.

Example 12.21: Consider the following sequence of Java statements:

```
Object o;  
o = new String();  
n = o.lengthO ;
```

Here  $o$  is declared to be an Object. Without analyzing what  $o$  refers to, all possible methods called "length" declared for all classes must be considered as possible targets. Knowing that  $o$  points to a String will narrow interprocedural analysis to precisely the method declared for String. •

It is possible to apply approximations to reduce the number of targets. For example, statically we can determine what are all the types of objects created, and we can limit the analysis to those. But we can be more accurate if we can discover the call graph on the fly, based on the points-to analysis obtained at the same time. More accurate call graphs lead not only to more precise results but also can reduce greatly the analysis time otherwise needed.

Points-to analysis is complicated. It is not one of those "easy" data flow problems where we only need to simulate the effect of going around a loop of statements once. Rather, as we discover new targets for a pointer, all statements assigning the contents of that pointer to another pointer need to be re-analyzed.

For simplicity, we shall focus mainly on Java. We shall start with flow-insensitive and context-insensitive analysis, assuming for now that no methods are called in the program. Then, we describe how we can discover the call graph on the fly as the points-to results are computed. Finally, we describe one way of handling context sensitivity.

### 12.4.2 A Model for Pointers and References

Let us suppose that our language has the following ways to represent and manipulate references:

1. Certain program variables are of type "pointer to  $T$ " or "reference to  $T$ ," where  $T$  is a type. These variables are either static or live on the run-time stack. We call them simply *variables*.
2. There is a heap of objects. All variables point to heap objects, not to other variables. These objects will be referred to as *heap objects*.
3. A heap object can have *fields*, and the value of a field can be a reference to a heap object (but not to a variable).

Java is modeled well by this structure, and we shall use Java syntax in examples. Note that C is modeled less well, since pointer variables can point to other pointer variables in C, and in principle, any C value can be coerced into a pointer.

Since we are performing an insensitive analysis, we only need to assert that a given variable  $v$  can point to a given heap object  $h$ ; we do not have to address the issue of where in the program  $v$  can point to  $h$ , or in what contexts  $v$  can point to  $h$ . Note, however, that variables can be named by their full name. In Java, this name can incorporate the module, class, method, and block within a method, as well as the variable name itself. Thus, we can distinguish many variables that have the same identifier.

Heap objects do not have names. Approximation often is used to name the objects, because an unbounded number of objects may be created dynamically. One convention is to refer to objects by the statement at which they are created. As a statement can be executed many times and create a new object each time, an assertion like " $v$  can point to  $/i$ " really means " $v$  can point to One or more of the objects created at the statement labeled  $h$ ."

The goal of the analysis is to determine what each variable and each field of each heap object can point to. We refer to this as a *points-to analysis*; two pointers are aliased if their points-to sets intersect. We describe here an *inclusion-based* analysis; that is, a statement such as  $v = w$  causes variable  $v$  to point to all the objects  $w$  points to, but not vice versa. While this approach may seem obvious, there are other alternatives to how we define points-to analysis. For example, we can define an *equivalence-based* analysis such that a statement like  $v = w$  would turn variables  $v$  and  $w$  into one equivalence class, pointing

to all the variables that each can point to. While this formulation does not approximate aliases well, it provides a quick, and often good, answer to the question of which variables point to the same kind of objects.

### 12.4.3 Flow Insensitivity

We start by showing a very simple example to illustrate the effect of ignoring control flow in points-to analysis.

**Example 12.22:** In Fig. 12.20, three objects, *h*, *i*, and *j*, are created and assigned to variables *a*, *b*, and *c*, respectively. Thus, surely *a* points to *h*, *b* points to *i*, and *c* points to *j* by the end of line (3).

```

1)  h:  a = new Object();
2)  i:  b = new ObjectO ;
3)  j:  c = new Object();
4)      a = b;
5)      b = c;
6)      c = a;

```

Figure 12.20: Java code for Example 12.22

If you follow the statements (4) through (6), you discover that after line (4) *a* points only to *i*. After line (5), *b* points only to *j*, and after line (6), *c* points only to *i*. •

The above analysis is flow sensitive because we follow the control flow and compute what each variable can point to after each statement. In other words, in addition to considering what points-to information each statement "generates," we also account for what points-to information each statement "kills." For instance, the statement `b = c;` kills the previous fact "`b` points to *f*" and generates the new relationship "`b` points to what `c` points to."

A flow-insensitive analysis ignores the control flow, which essentially assumes that every statement in the program can be executed in any order. It computes only one global points-to map indicating what each variable can possibly point to at any point of the program execution. If a variable can point to two different objects after two different statements in a program, we simply record that it can point to both objects. In other words, in flow-insensitive analysis, an assignment does not "kill" any points-to relations but can only "generate" more points-to relations. To compute the flow-insensitive results, we repeatedly add the points-to effects of each statement on the points-to relationships until no new relations are found. Clearly, lack of flow sensitivity weakens the analysis results greatly, but it tends to reduce the size of the representation of the results and make the algorithm converge faster.

Example 12.23: Returning to Example 12.22, lines (1) through (3) again tell us  $a$  can point to  $h$ ;  $b$  can point to  $i$ , and  $c$  can point to  $j$ . With lines (4) and (5),  $a$  can point to both  $h$  and  $i$ , and  $b$  can point to both  $i$  and  $j$ . With line (6),  $c$  can point to  $h, i$ , and  $j$ . This information affects line (5), which in turn affects line (4). In the end, we are left with the useless conclusion that anything can point to anything. •

#### 12.4.4 The Formulation in Datalog

Let us now formalize a flow-insensitive pointer-alias analysis based on the discussion above. We shall ignore procedure calls for now and concentrate on the four kinds of statements that can affect pointers:

1. *Object creation*,  $h: T \ v = \text{new } T();$  This statement creates a new heap object, and variable  $v$  can point to it.
2. *Copy statement*,  $v = w;$  Here,  $v$  and  $w$  are variables. The statement makes  $v$  point to whatever heap object  $w$  currently points to; i.e.,  $w$  is copied into  $v$ .
3. *Field store*,  $v.f = w;$  The type of object that  $v$  points to must have a field  $f$ , and this field must be of some reference type. Let  $v$  point to heap object  $h$ , and let  $w$  point to  $g$ . This statement makes the field  $f$ , in  $h$  now point to  $g$ . Note that the variable  $v$  is unchanged.
4. *Field load*,  $v = w.f;$  Here,  $if$  is a variable pointing to some heap object that has a field  $f$ , and  $f$  points to some heap object  $h$ . The statement makes variable  $v$  point to  $h$ .

Note that compound field accesses in the source code such as  $v = w.f.g$  will be broken down into two primitive field-load statements:

```

vl = w.f;
v = vl.g;

```

Let us now express the analysis formally in Datalog rules. First, there are only two IDB predicates we need to compute:

1.  $pts(V, H)$  means that variable  $V$  can point to heap object  $H$ .
2.  $hpts(H, F, G)$  means that field  $F$  of heap object  $H$  can point to heap object  $G$ .

The EDB relations are constructed from the program itself. Since the location of statements in a program is irrelevant when the analysis is flow-insensitive, we only have to assert in the EDB the existence of statements that have certain forms. In what follows, we shall make a convenient simplification. Instead of defining EDB relations to hold the information garnered from the



program, we shall use a quoted statement form to suggest the EDB relation or relations that represent the existence of such a statement. For example, " $H : TV = \text{new } T$ " is an EDB fact asserting that at statement  $H$  there is an assignment that makes variable  $V$  point to a new object of type  $T$ . We assume that in practice, there would be a corresponding EDB relation that would be populated with ground atoms, one for each statement of this form in the program.

With this convention, all we need to write the Datalog program is one rule for each of the four types of statements. The program is shown in Fig. 12.21. Rule (1) says that variable  $V$  can point to heap object  $H$  if statement  $H$  is an assignment of a new object to  $V$ . Rule (2) says that if there is a copy statement  $V = W$ , and  $W$  can point to  $H$ , then  $V$  can point to  $H$ .

```

1)    pts(V,H)    :-    "H: TV = new T"

2)    pts(V,H)    :-    «V = W»k
                        pts(W, H)

3)    hpts(HF,G)  :-    "V.F = W" &
                        pts(W,G) &
                        pts(V,H)

4)    pts(V,H)    :-    "V = W.F"8c
                        pts(W,G) &
                        hpts(G,F,H)

```

Figure 12.21: Datalog program for flow-insensitive pointer analysis

Rule (3) says that if there is a statement of the form  $V.F = W$ ,  $W$  can point to  $C7$ , and  $V$  can point to  $H$ , then the  $F$  field of  $H$  can point to  $G$ . Finally, rule (4) says that if there is a statement of the form  $V = W.F$ ,  $W$  can point to  $G$ , and the  $F$  field of  $G$  can point to  $H$ , then  $V$  can point to  $H$ . Notice that  $pts$  and  $hpts$  are mutually recursive, but this Datalog program can be evaluated by either of the iterative algorithms discussed in Section 12.3.4.

### 12.4.5 Using Type Information

Because Java is type safe, variables can only point to types that are compatible to the declared types. For example, assigning an object belonging to a superclass of the declared type of a variable would raise a run-time exception. Consider the simple example in Fig. 12.22, where  $S$  is a subclass of  $T$ . This program will generate a run-time exception if  $p$  is true, because  $a$  cannot be assigned an object of class  $T$ . Thus, statically we can conclude that because of the type restriction,  $a$  can only point to  $h$  and not  $g$ .

```

    S a;
    T b;
    if (p) {
g:   b = new T();
    y else
h:   b = new S();
    }
    a = b;

```

Figure 12.22: Java program with a type error

Thus, we introduce to our analysis three EDB predicates that reflect important type information in the code being analyzed. We shall use the following:

1.  $vType(V, T)$  says that variable  $V$  is declared to have type  $T$ .
2.  $hType(H, T)$  says that heap object  $H$  is allocated with type  $T$ . The type of a created object may not be known precisely if, for example, the object is returned by a native method. Such types are modeled conservatively as all possible types.
3.  $assignable(T, S)$  means that an object of type  $S$  can be assigned to a variable with the type  $T$ . This information is generally gathered from the declaration of subtypes in the program, but also incorporates information about the predefined classes of the language.  $assignable(T, T)$  is always true.

We can modify the rules from Fig. 12.21 to allow inferences only if the variable assigned gets a heap object of an assignable type. The rules are shown in Fig. 12.23.

The first modification is to rule (2). The last three subgoals say that we can only conclude that  $V$  can point to  $H$  if there are types  $T$  and  $S$  that variable  $V$  and heap object  $H$  may respectively have, such that objects of type  $S$  can be assigned to variables that are references to type  $T$ . A similar additional restriction has been added to rule (4). Notice that there is no additional restriction in rule (3) because all stores must go through variables. Any type restriction would only catch one extra case, when the base object is a null constant.

### 12.4.6 Exercises for Section 12.4

Exercise 12.4.1: In Fig. 12.24,  $h$  and  $g$  are labels used to represent newly created objects, and are not part of the code. You may assume that objects of type  $T$  have a field  $/$ . Use the Datalog rules of this section to infer all possible  $pts$  and  $hpts$  facts.

- 1)  $pts(V,H) \quad :- \quad "H: TV = \mathbf{new} T$
- 2)  $pts(V,H) \quad :- \quad "V = W"8c$   
 $pts(W,H) \quad \&$   
 $vType(V,T) \quad \&$   
 $hType(H, S) \quad \&$   
 $assignable(T, S)$
- 3)  $hpts(H,F,G) \quad :- \quad "V.F = PF" \quad \&$   
 $pis(VF,G) \quad \&$   
 $pts(V,H)$
- 4)  $pteCV,!*) \quad :- \quad =$   
 $pts(W,G) \quad \&$   
 $hpts(G,F,H) \quad \&$   
 $vType(V, T) \quad \&$   
 $hType(H, S) \quad \&$   
 $assignable(T, S)$

Figure 12.23: Adding type restrictions to flow-insensitive pointer analysis

```

h: T a = new T O ;
   T b = new T O ;
   T c = a ;
   a.,f = b ;
   b.,f = c ;
   T d = c.f ;

```

Figure 12.24: Code for Exercise 12.4.1

**! Exercise 12.4.2:** Applying the algorithm of this section to the code

```

h: T a = new T ( ) ;
g:   b = new T O ;
   T c = a ;

```

would infer that both  $a$  and  $b$  can point to  $h$  and  $g$ . Had the code been written

```

h: T a = new T ( ) ;
g:   b = new T O ;
   T c = b ;

```

we would infer accurately that  $a$  can point to  $h$ , and  $b$  and  $c$  can point to  $g$ . Suggest an intraprocedural data-flow analysis that can avoid this kind of inaccuracy.

```

t p(t x) {
    h: T a = new T;
    a.f = x;
    return a;
}

void main()
    g: T b = new T;
    b = p(b);
    b = b.f;
}

```

Figure 12.25: Example code for pointer analysis

! Exercise 12.4.3: We can extend the analysis of this section to be interprocedural if we simulate call and return as if they were copy operations, as in rule (2) of Fig. 12.21. That is, a call copies the actuals to their corresponding formals, and the return copies the variable that holds the return value to the variable that is assigned the result of the call. Consider the program of Fig. 12.25.

- a) Perform an insensitive analysis on this code.
- b) Some of the inferences made in (a) are actually "bogus," in the sense that they do not represent any event that can occur at run-time. The problem can be traced to the multiple assignments to variable *b*. Rewrite the code of Fig. 12.25 so that no variable is assigned more than once. Rerun the analysis and show that each inferred *pts* and *hpts* fact can occur at run time.

## 12.5 Context-Insensitive Interprocedural Analysis

We now consider method invocations. We first explain how points-to analysis can be used to compute a precise call graph, which is useful in computing precise points-to results. We then formalize on-the-fly call-graph discovery and show how Datalog can be used to describe the analysis succinctly.

### 12.5.1 Effects of a Method Invocation

The effects of a method call such as  $x = y.n(z)$  in Java on the points-to relations can be computed as follows:

1. Determine the type of the receiver object, which is the object that *y* points to. Suppose its type is *t*. Let *m* be the method named *n* in the narrowest

superclass of  $t$  that has a method named  $n$ . Note that, in general, which method is invoked can only be determined dynamically.

2. The formal parameters of  $m$  are assigned the objects pointed to by the actual parameters. The actual parameters include not just the parameters passed in directly, but also the receiver object itself. Every method invocation assigns the receiver object to the `this` variable.<sup>3</sup> We refer to the `this` variables as the 0th formal parameters of methods. In `x = y.n(z)`, there are two formal parameters: the object pointed to by  $y$  is assigned to variable `this`, and the object pointed to by  $z$  is assigned to the first declared formal parameter of  $m$ .
3. The returned object of  $m$  is assigned to the left-hand-side variable of the assignment statement.

In context-insensitive analysis, parameters and returned values are modeled by copy statements. The interesting question that remains is how to determine the type of the receiver object. We can conservatively determine the type according to the declaration of the variable; for example, if the declared variable has type `t` then only methods named  $n$  in subtypes of  $t$  can be invoked. Unfortunately, if the declared variable has type `Object`, then all methods with name  $n$  are all potential targets. In real-life programs that use object hierarchies extensively and include many large libraries, such an approach can result in many spurious call targets, making the analysis both slow and imprecise.

We need to know what the variables can point to in order to compute the call targets; but unless we know the call targets, we cannot find out what all the variables can point to. This recursive relationship requires that we discover the call targets on the fly as we compute the points-to set. The analysis continues until no new call targets and no new points-to relations are found.

**Example 12.24:** In the code in Fig. 12.26,  $r$  is a subtype of  $s$ , which itself is a subtype of  $t$ . Using only the declared type information, `a.n()` may invoke any of the three declared methods with name `n` since  $s$  and  $r$  are both subtypes of  $a$ 's declared type,  $t$ . Furthermore, it appears that  $a$  may point to objects  $g$ ,  $h$ , and  $i$  after line (5).

By analyzing the points-to relationships, we first determine that  $a$  can point to  $j$ , an object of type  $t$ . Thus, the method declared in line (1) is a call target. Analyzing line (1), we determine that  $a$  also can point to  $g$ , an object of type  $r$ . Thus, the method declared in line (3) may also be a call target, and  $a$  can now also point to  $i$ , another object of type  $r$ . Since there are no more new call targets, the analysis terminates without analyzing the method declared in line (2) and without concluding that  $a$  can point to  $h$ . •

<sup>3</sup>Remember that variables are distinguished by the method to which they belong, so there is not just one variable named `this`, but rather one such variable for each method in the program.

```

class t {
1) g:   t n() { return new r(); }
      }
      class s extends t {
2) h:   t n() { return new s(); }
      }
      class r extends s {
3) i:   t n() { return new r(); }
      }

      main () {
4) j:   t a = new t();
5)      a = a.n();
      }

```

Figure 12.26: A virtual method invocation

### 12.5.2 Call Graph Discovery in Datalog

To formulate the Datalog rules for context-insensitive interprocedural analysis, we introduce three EDB predicates, each of which is obtainable easily from the source code:

1. *actual*( $S, I, V$ ) says  $V$  is the  $I$ th actual parameter used in call site  $S$ .
2. *formal*( $M, I, V$ ) says that  $V$  is  $I$ th formal parameter declared in method  $M$ .
3. *cha*( $T, N, M$ ) says that  $M$  is the method called when  $N$  is invoked on a receiver object of type  $T$ . (*cha* stands for class hierarchy analysis).

Each edge of the call graph is represented by an IDB predicate *invokes*. As we discover more call-graph edges, more points-to relations are created as the parameters are passed in and returned values are passed out. This effect is summarized by the rules shown in Figure 12.27.

The first rule computes the call target of the call site. That is, " $5 : V.N(\dots)$ " says that there is a call site labeled  $S$  that invokes method named  $N$  on the receiver object pointed to by  $V$ . The subgoals say that if  $V$  can point to heap object  $H$ , which is allocated as type  $T$ , and  $M$  is the method used when  $N$  is invoked on objects of type  $T$ , then call site  $S$  may invoke method  $M$ .

The second rule says that if site  $S$  can call method  $M$ , then each formal parameter of  $M$  can point to whatever the corresponding actual parameter of the call can point to. The rule for handling returned values is left as an exercise.

Combining these two rules with those explained in Section 12.4 create a context-insensitive points-to analysis that uses a call graph that is computed on the fly. This analysis has the side effect of creating a call graph using a

```

1)  invokes(S,M)    "S : V.N(...)" &
                        pts(V, H) &
                        hType(H, T) &
                        cha(T, N, M)

                        pts(V,H)    invokes(S, M) &
                        formal(M,I,V) &
                        actual(S,I,W) &
                        pts(W,H)

```

Figure 12.27: Datalog program for call-graph discovery

context-insensitive and flow-insensitive points-to analysis. This call graph is significantly more accurate than one computed based only on type declarations and syntactic analysis.

### 12.5.3 Dynamic Loading and Reflection

Languages like Java allow dynamic loading of classes. It is impossible to analyze all the possible code executed by a program, and hence impossible to provide any conservative approximation of call graphs or pointer aliases statically. Static analysis can only provide an approximation based on the code analyzed. Remember that all the analyses described here can be applied at the Java bytecode level, and thus it is not necessary to examine the source code. This option is especially significant because Java programs tend to use many libraries.

Even if we assume that all the code to be executed is analyzed, there is one more complication that makes conservative analysis impossible: reflection. Reflection allows a program to determine dynamically the types of objects to be created, the names of methods invoked, as well as the names of the fields accessed. The type, method, and field names can be computed or derived from user input, so in general the only possible approximation is to assume the universe.

Example 12.25 : The code below shows a common use of reflection:

```

1)  String className = ...;
2)  Class c = Class.forName(className);
3)  Object o = c.newInstance();
4)  T t = (T) o;

```

The `forName` method in the `Class` library takes a string containing the class name and returns the class. The method `newInstance` returns an instance of that class. Instead of leaving the object `o` with type `Object`, this object is cast to a superclass `T` of all the expected classes. •

While many large Java applications use reflection, they tend to use common idioms, such as the one shown in Example 12.25. As long as the application does not redefine the class loader, we can tell the class of the object if we know the value of `className`. If the value of `className` is defined in the program, because strings are immutable in Java, knowing what `className` points to will provide the name of the class. This technique is another use of points-to analysis. If the value of `className` is based on user input, then the points-to analysis can help locate where the value is entered, and the developer may be able to limit the scope of its value.

Similarly, we can exploit the typecast statement, line (4) in Example 12.25, to approximate the type of dynamically created objects. Assuming that the typecast exception handler has not been redefined, the object must belong to a subclass of the class *T*.

### 12.5.4 Exercises for Section 12.5

Exercise 12.5.1: For the code of Fig. 12.26

- a) Construct the EDB relations *actual*, *formal*, and *cha*.
- b) Make all possible inferences of *pts* and *hpts* facts.

Exercise 12.5.2: How would you add to the EDB predicates and rules of Section 12.5.2 additional predicates and rules to take into account the fact that if a method call returns an object, then the variable to which the result of the call is assigned can point to whatever the variable holding the return value can point to?

## 12.6 Context-Sensitive Pointer Analysis

As discussed in Section 12.1.2, context sensitivity can improve greatly the precision of interprocedural analysis. We talked about two approaches to interprocedural analysis, one based on cloning (Section 12.1.4) and one on summaries (Section 12.1.5). Which one should we use?

There are several difficulties in computing the summaries of points-to information. First, the summaries are large. Each method's summary must include the effect of all the updates that the function and all its callees can make, in terms of the incoming parameters. That is, a method can change the points-to sets of all data reachable through static variables, incoming parameters and all objects created by the method and its callees. While complicated schemes have been proposed, there is no known solution that can scale to large programs. Even if the summaries can be computed in a bottom-up pass, computing the points-to sets for all the exponentially many contexts in a typical top-down pass presents an even greater problem. Such information is necessary for global queries like finding all points in the code that touch a certain object.



In this section, we discuss a cloning-based context-sensitive analysis. A cloning-based analysis simply clones the methods, one for each context of interest. We then apply the context-insensitive analysis to the cloned call graph. While this approach seems simple, the devil is in the details of handling the large number of clones. How many contexts are there? Even if we use the idea of collapsing all recursive cycles, as discussed in Section 12.1.3, it is not uncommon to find  $10^{14}$  contexts in a Java application. Representing the results of these many contexts is the challenge.

We separate the discussion of context sensitivity into two parts:

1. How to handle context sensitivity logically? This part is easy, because we simply apply the context-insensitive algorithm to the cloned call graph.
2. How to represent the exponentially many contexts? One way is to represent the information as binary decision diagrams (BDD's), a highly-optimized data structure that has been used for many other applications.

This approach to context sensitivity is an excellent example of the importance of abstraction. As we are going to show, we eliminate algorithmic complexity by leveraging the years of work that went into the BDD abstraction. We can specify a context-sensitive points-to analysis in just a few lines of Datalog, which in turn takes advantage of many thousands of lines of existing code for BDD manipulation. This approach has several important advantages. First, it makes possible the easy expression of further analyses that use the results of the points-to analysis. After all, the points-to results on their own are not interesting. Second, it makes it much easier to write the analysis correctly, as it leverages many lines of well-debugged code.

### 12.6.1 Contexts and Call Strings

The context-sensitive points-to analysis described below assumes that a call graph has been already computed. This step helps make possible a compact representation of the many calling contexts. To get the call graph, we first run a context-insensitive points-to analysis that computes the call graph on the fly, as discussed in Section 12.5. We now describe how to create a cloned call graph.

A context is a representation of the call string that forms the history of the active function calls. Another way to look at the context is that it is a summary of the sequence of calls whose activation records are currently on the run-time stack. If there are no recursive functions on the stack, then the call string — the sequence of locations from which the calls on the stack were made — is a complete representation. It is also an acceptable representation, in the sense that there is only a finite number of different contexts, although that number may be exponential in the number of functions in the program.

However, if there are recursive functions in the program, then the number of possible call strings is infinite, and we cannot allow all possible call strings to represent distinct contexts. There are various ways we can limit the number of

distinct contexts. For example, we can write a regular expression that describes all possible call strings and convert that regular expression to a deterministic finite automaton, using the methods of Section 3.7. The contexts can then be identified with the states of this automaton.

Here, we shall adopt a simpler scheme that captures the history of nonrecursive calls but considers recursive calls to be "too hard to unravel." We begin by finding all the mutually recursive sets of functions in the program. The process is simple and will not be elaborated in detail here. Think of a graph whose nodes are the functions, with an edge from  $p$  to  $q$  if function  $p$  calls function  $q$ . The strongly connected components (SCC's) of this graph are the sets of mutually recursive functions. As a common special function  $p$  that calls itself, but is not in an SCC with any other function is an SCC by itself. The nonrecursive functions are also SCC's by themselves. Call an SCC *nontrivial* if it either has more than one member (the mutually recursive case), or it has a single, recursive member. The SCC's that are single, nonrecursive functions are *trivial* SCC's.

Our modification of the rule that any call string is a context is as follows. Given a call string, delete the occurrence of a call site  $s$  if

1.  $s$  is in a function  $p$ .
2. Function  $q$  is called at site  $s$  ( $q = p$  is possible).
3.  $p$  and  $q$  are in the same strong component (i.e.,  $p$  and  $q$  are mutually recursive, or  $p = q$  and  $p$  is recursive).

The result is that when a member of a nontrivial SCC  $S$  is called, the call site for that call becomes part of the context, but calls within  $S$  to other functions in the same SCC are not part of the context. Finally, when a call outside  $S$  is made, we record that call site as part of the context.

Example 12.26: In Fig. 12.28 is a sketch of five methods with some call sites and calls among them. An examination of the calls shows that  $q$  and  $r$  are mutually recursive. However,  $p$ ,  $s$ , and  $t$  are not recursive at all. Thus, our contexts will be lists of all the call sites except **s3** and **s5**, where the recursive calls between  $q$  and  $r$  take place.

Let us consider all the ways we could get from  $p$  to  $t$ , that is, all the contexts in which calls to  $t$  occur:

1.  $p$  could call  $s$  at **s2**, and then  $s$  could call  $t$  at either **s7** or **s8**. Thus, two possible call strings are **(s2, s7)** and **(s2, s8)**.
2.  $p$  could call  $q$  at **si**. Then,  $q$  and  $r$  could call each other recursively some number of times. We could break the cycle:
  - (a) At **s4**, where  $t$  is called directly by  $q$ . This choice leads to only one context, **(si, s4)**.

```

void p() {
    h: T a = new T();
    si: T b = a.q();
    s2:     b.s();
}

T    q() i
    s3: T c = this.r0;
    i:  T d = new T();
    s4:     d.tQ;
    return d;
}

T    r() {
    s5: T e = this.q0;
    s6:     e.s();
    return e;
}

void s() {
    s7: T f = this.t0;
    s8:     f = f.t();
}

T    t() {
    j: T g = new T0;
    return g;
}

```

Figure 12.28: Methods and call sites for a running example

- (b) At **s6**, where *r* calls *s*. Here, we can reach *t* either by the call at **s7** or the call at **s8**. That gives us two more contexts, (*si*, **s6**, **s7**) and (*sl*, **s6**, **s8**).

There are thus five different contexts in which *t* can be called. Notice that all these contexts omit the recursive call sites, **s3** and **s5**. For example, the context (*si*, **s4**) actually represents the infinite set of call strings (*si*, **s3**, (**s5**, **s3**)<sup>*n*</sup>, **s4**) for all  $n > 0$ . •

We now describe how we derive the cloned call graph. Each cloned method is identified by the method in the program *M* and a context *C*. Edges can be derived by adding the corresponding contexts to each of the edges in the original call graph. Recall that there is an edge in the original call graph linking call site *S* with method *M* if the predicate *invokes*(*S*, *M*) is true. To add contexts

to identify the methods in the cloned call graph, we can define a corresponding *CSinvokes* predicate such that *CSinvokes(S, C, M, D)* is true if the call site *S* in context *C* calls the *D* context of method *M*.

### 12.6.2 Adding Context to Datalog Rules

To find context-sensitive points-to relations, we can simply apply the same context-insensitive points-to analysis to the cloned call graph. Since a method in the cloned call graph is represented by the original method and its context, we revise all the Datalog rules accordingly. For simplicity, the rules below do not include the type restriction, and the *\_*'s are any new variables.

- 1)  $pts(V, C, H) \quad :- \quad "H : TV = new T()" \ \&$   
 $CSinvokes(H, C, \_ , \_)$
- 2)  $pts(V, C, H) \quad :- \quad "V = W" \ k$   
 $pts(W, C, H)$
- 3)  $hpts(H, F, G) \quad :- \quad "V.F = W" \ k$   
 $pts(W, C, G) \quad k$   
 $pts(V, C, \quad H)$
- 4)  $pts(V, C, H) \quad :- \quad "V = W.F" \ k$   
 $pts(W, C, G) \quad k$   
 $hpts(G, \quad F, \quad H)$
- 5)  $pts(V, D, H) \quad :- \quad CSinvokes(S, C, M, D) \quad k$   
 $formal(M, I, V) \quad k$   
 $actual(S, I, W) \ \&$   
 $pts(W, C, \quad H)$

Figure 12.29: Datalog program for context-sensitive points-to analysis

An additional argument, representing the context, must be given to the IDB predicate *pts*. *pts(V, C, H)* says that variable *V* in context *C* can point to heap object *H*. All the rules are self-explanatory, perhaps with the exception of Rule 5. Rule 5 says that if the call site *S* in context *C* calls method *M* of context *D*, then the formal parameters in method *M* of context *D* can point to the objects pointed to by the corresponding actual parameters in context *C*.

### 12.6.3 Additional Observations About Sensitivity

What we have described is one formulation of context sensitivity that has been shown to be practical enough to handle many large real-life Java programs,

using the tricks described briefly in the next section. Nonetheless, this algorithm cannot yet handle the largest of Java applications.

The heap objects in this formulation are named by their call site, but without context sensitivity. That simplification can cause problems. Consider the object-factory idiom where, all objects of the same type are allocated by the same routine. The current scheme would make all objects of that class share the same name. It is relatively simple to handle such cases by essentially inlining the allocation code. In general, it is desirable to increase the context sensitivity in the naming of objects. While it is easy to add context sensitivity of objects to the Datalog formulation, getting the analysis to scale to large programs is another matter.

Another important form of sensitivity is object sensitivity. An object-sensitive technique can distinguish between methods invoked on different receiver objects. Consider the scenario of a call site in a calling context where a variable is found to point to two different receiver objects of the same class. Their fields may point to different objects. Without distinguishing between the objects, a copy among fields of the `this` object reference will create spurious relationships unless we separate the analysis according to the receiver objects. Object sensitivity is more useful than context sensitivity for some analyses.

#### 12.6.4 Exercises for Section 12.6

```

void pO {
    h: T a = new TO ;
    i: T b = new T();
    c1: T c = a.q(b);

    q(T y) <
        j: T d = new T();
    c2:  d = this.q(d);
    c3:  d = d.q(y);
    c4:  d = d.r();
        return d;

T    r() {
        return this;
}

```

Figure 12.30: Code for Exercises 12.6.1 and 12.6.2

Exercise 12.6.1: What are all the contexts that would be distinguished if we apply the methods of this section to the code in Fig. 12.30?

- ! Exercise **12.6.2**: Perform a context sensitive analysis of the code in Fig. 12.30.
- ! Exercise **12.6.3**: Extend the Datalog rules of this section to incorporate the type and subtype information, following the approach of Section 12.5.

## 12.7 Datalog Implementation by BDD's

*Binary Decision Diagrams* (BDD's) are a method for representing boolean functions by graphs. Since there are  $2^n$  boolean functions of  $n$  variables, no representation method is going to be very succinct on all boolean functions. However, the boolean functions that appear in practice tend to have a lot of regularity. It is thus common that one can find a succinct BDD for functions that one really wants to represent.

It turns out that the boolean functions that are described by the Datalog programs that we have developed to analyze programs are no exception. While succinct BDD's representing information about a program often must be found using heuristics and/or techniques used in commercial BDD-manipulating packages, the BDD approach has been quite successful in practice. In particular, it outperforms methods based on conventional database-management systems, because the latter are designed for the more irregular data patterns that appear in typical commercial data.

It is beyond the scope of this book to cover all of the BDD technology that has been developed over the years. We shall here introduce you to the BDD notation. We then suggest how one represents relational data as BDD's and how one could manipulate BDD's to reflect the operations that are performed to execute Datalog programs by algorithms such as Algorithm 12.18. Finally, we describe how to represent the exponentially many contexts in BDD's, the key to the success of the use of BDD's in context-sensitive analysis.

### 12.7.1 Binary Decision Diagrams

A BDD represents a boolean function by a rooted DAG. The interior nodes of the DAG are each labeled by one of the variables of the represented function. At the bottom are two leaves, one labeled 0 the other labeled 1. Each interior node has two edges to children; these edges are called "low" and "high." The low edge is associated with the case that the variable at the node has value 0, and the high edge is associated with the case where the variable has value 1.

Given a truth assignment for the variables, we can start at the root, and at each node, say a node labeled  $x$ , follow the low or high edge, depending on whether the truth value for  $x$  is 0 or 1, respectively. If we arrive at the leaf labeled 1, then the represented function is true for this truth assignment; otherwise it is false.

**Example 12.27:** In Fig. 12.31 we see a BDD. We shall see the function it represents shortly. Notice that we have labeled all the "low" edges with 0 and

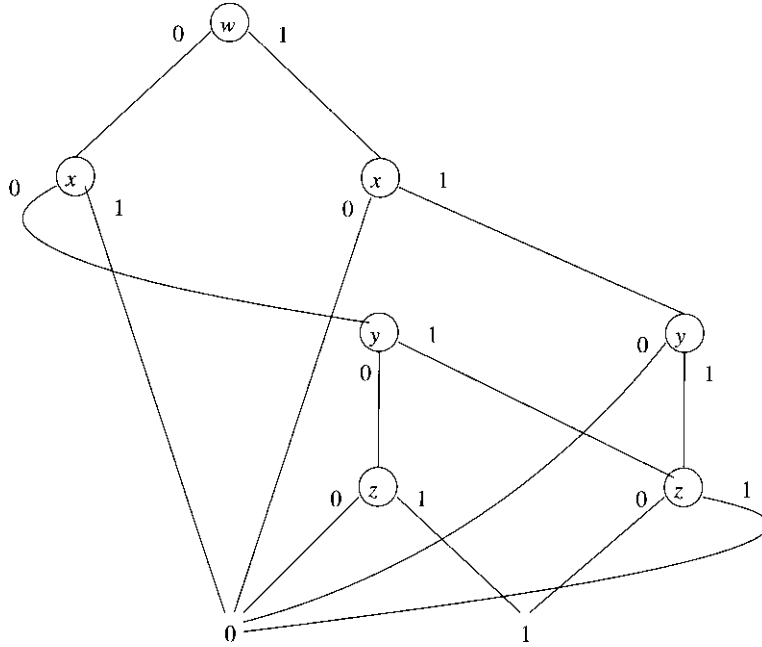

Figure 12.31: A binary decision diagram

all the "high" edges by 1. Consider the truth assignment for variables  $wxyz$  that sets  $w = x = y = 0$  and  $z = 1$ . Starting at the root, since  $w = 0$  we take the low edge, which gets us to the leftmost of the nodes labeled  $x$ . Since  $x = 0$ , we again follow the low edge from this node, which takes us to the leftmost of the nodes labeled  $y$ . Since  $y = 0$  we next move to the leftmost of the nodes labeled  $z$ . Now, since  $z = 1$ , we take the high edge and wind up at the leaf labeled 1. Our conclusion is that the function is true for this truth assignment.

Now, consider the truth assignment  $wxyz = 0101$ , that is,  $w = y = 0$  and  $x = z = 1$ . We again start at the root. Since  $w = 0$  we again move to the leftmost of the nodes labeled  $x$ . But now, since  $x = 1$ , we follow the high edge, which jumps to the 0 leaf. That is, we know not only that truth assignment 0101 makes the function false, but since we never even looked at  $y$  or  $z$ , any truth assignment of the form  $0lyz$  will also make the function have value 0. This "short-circuiting" ability is one of the reasons BDD's tend to be succinct representations of boolean functions. •

In Fig. 12.31 the interior nodes are in ranks — each rank having nodes with a particular variable as label. Although it is not an absolute requirement, it is convenient to restrict ourselves to *ordered BDD's*. In an ordered BDD, there is an order  $x_1, x_2, \dots, x_n$  to the variables, and whenever there is an edge from a parent node labeled  $X_i$  to a child labeled  $X_j$ , then  $i < j$ . We shall see that it is easier to operate on ordered BDD's, and from here we assume all BDD's are

ordered.

Notice also that BDD's are DAG's, not trees. Not only will the leaves 0 and 1 typically have many parents, but interior nodes also may have several parents. For example, the rightmost of the nodes labeled  $z$  in Fig. 12.31 has two parents. This combination of nodes that would result in the same decision is another reason that BDD's tend to be succinct.

### 12.7.2 Transformations on BDD's

We alluded, in the discussion above, to two simplifications on BDD's that help make them more succinct:

1. *Short-Circuiting*: If a node  $N$  has both its high and low edges go to the same node  $M$ , then we may eliminate  $N$ . Edges entering  $N$  go to  $M$  instead.
2. *Node-Merging*: If two nodes  $N$  and  $M$  have low edges that go to the same node and also have high edges that go to the same node, then we may merge  $N$  with  $M$ . Edges entering either  $N$  or  $M$  go to the merged node.

It is also possible to run these transformations in the opposite direction. In particular, we can introduce a node along an edge from  $N$  to  $M$ . Both edges from the introduced node go to  $M$ , and the edge from  $N$  now goes to the introduced node. Note, however, that the variable assigned to the new node must be one of those that lies between the variables of  $N$  and  $M$  in the order. Figure 12.32 shows the two transformations schematically.

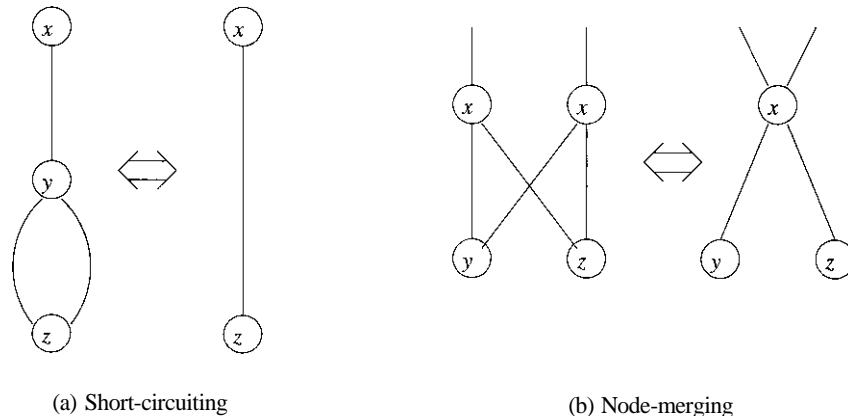

Figure 12.32: Transformations on BDD's



### 12.7.3 Representing Relations by BDD's

The relations with which we have been dealing have components that are taken from "domains." A domain for a component of a relation is the set of possible values that tuples can have in that component. For example, the relation  $pts(V, H)$  has the domain of all program variables for its first component and the domain of all object-creating statements for the second component. If a domain has more than  $2^{n-1}$  possible values but no more than  $2^n$  values, then it requires  $n$  bits or boolean variables to represent values in that domain.

A tuple in a relation may thus be viewed as a truth assignment to the variables that represent values in the domains for each of the components of the tuple. We may see a relation as a boolean function that returns the value true for all and only those truth assignments that represent tuples in the relation. An example should make these ideas clear.

Example 12.28: Consider a relation  $r(A, B)$  such that the domains of both  $A$  and  $B$  are  $\{a, b, c, d\}$ . We shall encode  $a$  by bits 00,  $b$  by 01,  $c$  by 10, and  $d$  by 11. Let the tuples of relation  $r$  be:

$A$	$B$
$a$	$b$
$a$	$c$
$d$	$c$

Let us use boolean variables  $wx$  to encode the first ( $A$ ) component and variables  $yz$  to encode the second ( $B$ ) component. Then the relation  $r$  becomes:

$w$	$X$	$y$	$z$
0	0	0	1
0	0	1	0
1	1	1	0

That is, the relation  $r$  has been converted into the boolean function that is true for the three truth-assignments  $wxyz = 0001, 0010,$  and  $1110$ . Notice that these three sequences of bits are exactly those that label the paths from the root to the leaf 1 in Fig. 12.31. That is, the BDD in that figure represents this relation  $r$ , if the encoding described above is used. •

### 12.7.4 Relational Operations as BDD Operations

Now we see how to represent relations as BDD's. But to implement an algorithm like Algorithm 12.18 (incremental evaluation of Datalog programs), we need to manipulate BDD's in a way that reflects how the relations themselves are manipulated. Here are the principal operations on relations that we need to perform:

1. *Initialization:* We need to create a BDD that represents a single tuple of a relation. We'll assemble these into BDD's that represent large relations by taking the union.
2. *Union:* To take the union of relations, we take the logical OR of the boolean functions that represent the relations. This operation is needed not only to construct initial relations, but also to combine the results of several rules for the same head predicate, and to accumulate new facts into the set of old facts, as in the incremental Algorithm 12.18.
3. *Projection:* When we evaluate a rule body, we need to construct the head relation that is implied by the true tuples of the body. In terms of the BDD that represents the relation, we need to eliminate the nodes that are labeled by those boolean variables that do not represent components of the head. We may also need to rename the variables in the BDD to correspond to the boolean variables for the components of the head relation.
4. *Join:* To find the assignments of values to variables that make a rule body true, we need to "join" the relations corresponding to each of the subgoals. For example, suppose we have two subgoals  $r(A,B) \wedge s(B,C)$ . The join of the relations for these subgoals is the set of  $(a, b, c)$  triples such that  $(a, b)$  is a tuple in the relation for  $r$ , and  $(b, c)$  is a tuple in the relation for  $s$ . We shall see that, after renaming boolean variables in BDD's so the components for the two  $B$ 's agree in variable names, the operation on BDD's is similar to the logical AND, which in turn is similar to the OR operation on BDD's that implements the union.

### BDD's for Single Tuples

To initialize a relation, we need to have a way to construct a BDD for the function that is true for a single truth assignment. Suppose the boolean variables are  $X_1, x_2, \dots, x_n$ , and the truth assignment is  $a_1, a_2, \dots, a_n$ , where each  $a_i$  is either 0 or 1. The BDD will have one node  $N_i$  for each  $X_i$ . If  $a_i = 0$ , then the high edge from  $N_i$  leads to the leaf 0, and the low edge leads to  $N_{i+1}$ , or to the leaf 1 if  $i = n$ . If  $a_i = 1$ , then we do the same, but the high and low edges are reversed.

This strategy gives us a BDD that checks whether each  $X_i$  has the correct value, for  $i = 1, 2, \dots, n$ . As soon as we find an incorrect value, we jump directly to the 0 leaf. We only wind up at the 1 leaf if all variables have their correct value.

As an example, look ahead to Fig. 12.33(b). This BDD represents the function that is true if and only if  $x = y = 0$ , i.e., the truth assignment 00.

## Union

We shall give in detail an algorithm for taking the logical OR of BDD's, that is, the union of the relations represented by the BDD's.

Algorithm 12.29: Union of BDD's.

**INPUT:** Two ordered BDD's with the same set of variables, in the same order.

**OUTPUT:** A BDD representing the function that is the logical OR of the two boolean functions represented by the input BDD's.

**METHOD:** We shall describe a recursive procedure for combining two BDD's. The induction is on the size of the set of variables appearing in the BDD's.

**BASIS:** Zero variables. The BDD's must both be leaves, labeled either 0 or 1. The output is the leaf labeled 1 if either input is 1, or the leaf labeled 0 if both are 0.

**INDUCTION:** Suppose there are  $k$  variables,  $y_1, y_2, \dots, y_u$  found among the two BDD's. Do the following:

1. If necessary, use inverse short-circuiting to add a new root so that both BDD's have a root labeled  $y_k$ .
2. Let the two roots be  $N$  and  $M$ ; let their low children be  $A_0$  and  $M_0$ , and let their high children be  $N_1$  and  $M_1$ . Recursively apply this algorithm to the BDD's rooted at  $A_0$  and  $M_0$ . Also, recursively apply this algorithm to the BDD's rooted at  $N_1$  and  $M_1$ . The first of these BDD's represents the function that is true for all truth assignments that have  $y_k = 0$  and that make one or both of the given BDD's true. The second represents the same for the truth assignments with  $y_k = 1$ .
3. Create a new root node labeled  $y_k$ . Its low child is the root of the first recursively constructed BDD, and its high child is the root of the second BDD.
4. Merge the two leaves labeled 0 and the two leaves labeled 1 in the combined BDD just constructed.
5. Apply merging and short-circuiting where possible to simplify the BDD.

•

Example 12.30: In Fig. 12.33(a) and (b) are two simple BDD's. The first represents the function  $x$  OR  $y$ , and the second represents the function

NOT  $x$  AND NOT  $y$

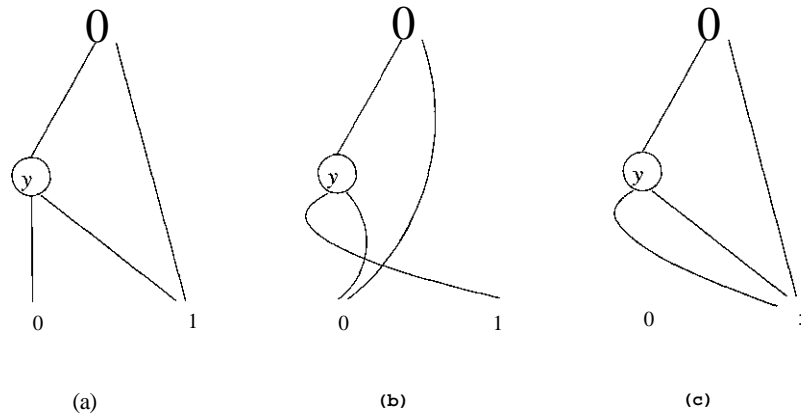

Figure 12.33: Constructing the BDD for a logical OR

Notice that their logical OR is the function 1 that is always true. To apply Algorithm 12.29 to these two BDD's, we consider the low children of the two roots and the high children of the two roots; let us take up the latter first.

The high child of the root in Fig. 12.33(a) is 1, and in Fig. 12.33(b) it is 0. Since these children are both at the leaf level, we do not have to insert nodes labeled  $y$  along each edge, although the result would be the same had we chosen to do so. The basis case for the union of 0 and 1 is to produce a leaf labeled 1 that will become the high child of the new root.

The low children of the roots in Fig. 12.33(a) and (b) are both labeled  $y$ , so we can compute their union BDD recursively. These two nodes have low children labeled 0 and 1, so the combination of their low children is the leaf labeled 1. Likewise, their high children are 1 and 0, so the combination is again the leaf 1. When we add a new root labeled  $x$ , we have the BDD seen in Fig. 12.33(c).

We are not done, since Fig. 12.33(c) can be simplified. The node labeled  $y$  has both children the node 1, so we can delete the node  $y$  and have the leaf 1 be the low child of the root. Now, both children of the root are the leaf 1, so we can eliminate the root. That is, the simplest BDD for the union is the leaf 1, all by itself. •

### 12.7.5 Using BDD's for Points-to Analysis

Getting context-insensitive points-to analysis to work is already nontrivial. The ordering of the BDD variables can greatly change the size of the representation. Many considerations, as well as trial and error, are needed to come up with an ordering that allows the analysis to complete quickly.

It is even harder to get context-sensitive points-to analysis to execute because of the exponentially many contexts in the program. In particular, if we

arbitrarily assign numbers to represent contexts in a call graph, we cannot handle even small Java programs. It is important that the contexts be numbered so that the binary encoding of the points-to analysis can be made very compact. Two contexts of the same method with similar call paths share a lot of commonalities, so it is desirable to number the  $n$  contexts of a method consecutively. Similarly, because pairs of caller-callees for the same call site share many similarities, we wish to number the contexts such that the numeric difference between each caller-callee pair of a call site is always a constant.

Even with a clever numbering scheme for the calling contexts, it is still hard to analyze large Java programs efficiently. Active machine learning has been found useful in deriving a variable ordering efficient enough to handle large applications.

### 12.7.6 Exercises for Section 12.7

**Exercise 12.7.1:** Using the encoding of symbols in Example 12.28, develop a BDD that represents the relation consisting of the tuples  $(6, b)$ ,  $(c, a)$ , and  $(6, a)$ . You may order the boolean variables in whatever way gives you the most succinct BDD.

**! Exercise 12.7.2:** As a function of  $n$ , how many nodes are there in the most succinct BDD that represents the exclusive-or function on  $n$  variables. That is, the function is true if an odd number of the  $n$  variables are true and false if an even number are true.

**Exercise 12.7.3:** Modify Algorithm 12.29 so it produces the intersection (logical AND) of two BDD's.

**!! Exercise 12.7.4:** Find algorithms to perform the following relational operations on the ordered BDD's that represent them:

- a) Project out some of the boolean variables. That is, the function represented should be true for a given truth assignment  $a$  if there was any truth assignment for the missing variables that, together with  $a$  made the original function true.
- b) Join two relations  $r$  and  $s$ , by combining a tuple from  $r$  with one from  $s$  whenever these tuples agree on the attributes that  $r$  and  $s$  have in common. It is really sufficient to consider the case where the relations have only two components, and one from each relation matches; that is, the relations are  $r(A, B)$  and  $s(B, C)$ .

## 12.8 Summary of Chapter 12

- *Interprocedural Analysis:* A data-flow analysis that tracks information across procedure boundaries is said to be interprocedural. Many analyses,

such as points-to analysis, can only be done in a meaningful way if they are interprocedural.

- *Call Sites:* Programs call procedures at certain points referred to as call sites. The procedure called at a site may be obvious, or it may be ambiguous, should the call be indirect through a pointer or a call of a virtual method that has several implementations.
- *Call Graphs:* A call graph for a program is a bipartite graph with nodes for call sites and nodes for procedures. An edge goes from a call-site node to a procedure node if that procedure may be called at the site.
- *Inlining:* As long as there is no recursion in a program, we can in principle replace all procedure calls by copies of their code, and use intraprocedural analysis on the resulting program. This analysis is in effect, interprocedural.
- *Flow Sensitivity and Context-Sensitivity:* A data-flow analysis that produces facts that depend on location in the program is said to be flow-sensitive. If the analysis produces facts that depend on the history of procedure calls is said to be context-sensitive. A data-flow analysis can be either flow- or context-sensitive, both, or neither.
- + *Cloning-Based Context-Sensitive Analysis:* In principle, once we establish the different contexts in which a procedure can be called, we can imagine that there is a clone of each procedure for each context. In that way, a context-insensitive analysis serves as a context-sensitive analysis.
- 4- *Summary-Based Context-Sensitive Analysis:* Another approach to interprocedural analysis extends the region-based analysis technique that was described for intraprocedural analysis. Each procedure has a transfer function and is treated as a region at each place where that procedure is called.
- + *Applications of Interprocedural Analysis:* An important application requiring interprocedural analysis is the detection of software vulnerabilities. These are often characterized by having data read from an untrusted input source by one procedure and used in an exploitable way by another procedure.
- *Datalog:* The language Datalog is a simple notation for if-then rules that can be used to describe data-flow analyses at a high level. Collections of Datalog rules, or Datalog programs, can be evaluated using one of several standard algorithms.
- *Datalog Rules:* A Datalog rule consists of a body (antecedent) and head (consequent). The body is one or more atoms, and the head is an atom. Atoms are predicates applied to arguments that are variables or constants.

The atoms of the body are connected by logical AND, and an atom in the body may be negated.

- + *IDB and EDB Predicates:* EDB predicates in a Datalog program have their true facts given a-priori. In a data-flow analysis, these predicates correspond to the facts that can be obtained from the code being analyzed. IDB predicates are defined by the rules themselves and correspond in a data-flow analysis to the information we are trying to extract from the code being analyzed.
- + *Evaluation of Datalog programs:* We apply rules by substituting constants for variables that make the body true. Whenever we do so, we infer that the head, with the same substitution for variables, is also true. This operation is repeated, until no more facts can be inferred.
- + *Incremental Evaluation of Datalog Programs:* An efficiency improvement is obtained by doing incremental evaluation. We perform a series of rounds. In one round, we consider only substitutions of constants for variables that make at least one atom of the body be a fact that was just discovered on the previous round.
- + *Java Pointer Analysis:* We can model pointer analysis in Java by a framework in which there are reference variables that point to heap objects, which may have fields that point to other heap objects. An insensitive pointer analysis can be written as a Datalog program that infers two kinds of facts: a variable can point to a heap object, or a field of a heap object can point to another heap object.
- + *Type Information to Improve Pointer Analysis:* We can get more precise pointer analysis if we take advantage of the fact that reference variables can only point to heap objects that are of the same type as the variable or a subtype.
- *Interprocedural Pointer Analysis:* To make the analysis interprocedural, we must add rules that reflect how parameters are passed and return values assigned to variables. These rules are essentially the same as the rules for copying one reference variable to another.
- *Call-Graph Discovery:* Since Java has virtual methods, interprocedural analysis requires that we first limit what procedures can be called at a given call site. The principal way to discover limits on what can be called where is to analyze the types of objects and take advantage of the fact that the actual method referred to by a virtual method call must belong to an appropriate class.
- *Context-Sensitive Analysis:* When procedures are recursive, we must condense the information contained in call strings into a finite number of contexts. An effective way to do so is to drop from the call string any

call site where a procedure calls another procedure (perhaps itself) with which it is mutually recursive. Using this representation, we can modify the rules for intraprocedural pointer analysis so the context is carried along in predicates; this approach simulates cloning-based analysis.

- 4 *Binary Decision Diagrams:* BDD's are a succinct representation of boolean functions by rooted DAG's. The interior nodes correspond to boolean variables and have two children, low (representing truth value 0) and high (representing 1). There are two leaves labeled 0 and 1. A truth assignment makes the represented function true if and only if the path from the root in which we go to the low child if the variable at a node is 0 and to the high child otherwise, leads to the 1 leaf.
- 4 *BDD's and Relations:* A BDD can serve as a succinct representation of one of the predicates in a Datalog program. Constants are encoded as truth assignments to a collection of boolean variables, and the function represented by the BDD is true if and only if the boolean variables represent a true fact for that predicate.
- 4 *Implementing Data-Flow Analysis by BDD's:* Any data-flow analysis that can be expressed as Datalog rules can be implemented by manipulations on the BDD's that represent the predicates involved in those rules. Often, this representation leads to a more efficient implementation of the data-flow analysis than any other known approach.

## 12.9 References for Chapter 12

Some of the basic concepts in interprocedural analysis can be found in [1, 6, 7, and 21]. Callahan et al. [11] describe an interprocedural constant-propagation algorithm.

Steensgaard [22] published the first scalable pointer-alias analysis. It is context-insensitive, flow-insensitive, and equivalence-based. A context-insensitive version of the inclusion-based points-to analysis was derived by Andersen [2]. Later, Heintze and Tardieu [15] described an efficient algorithm for this analysis. Fahndrich, Rehof, and Das [14] presented a context-sensitive, flow-insensitive, equivalence-based analysis that scales to large programs like gcc. Notable among previous attempts to create a context-sensitive, inclusion-based points-to analysis is Emami, Ghiya, and Hendren [13], which is a cloning-based context-sensitive, flow-sensitive, inclusion-based, points-to algorithm.

Binary decision diagrams (BDD's) first appeared in Bryant [9]. Their first use for data-flow analysis was by Berndl et al. [4]. The application of BDD's to insensitive pointer analysis is reported by Zhu [25] and Berndl et al. [8]. Whaley and Lam [24] describe the first context-sensitive, flow-insensitive, inclusion-based algorithm that has been shown to apply to real-life applications. The paper describes a tool called bddbldb that automatically translates analysis



described in Datalog into BDD code. Object-sensitivity was introduced by Milanova, Rountev, and Ryder [18].

For a discussion of Datalog, see Ullman and Widom [23]. Also see Lam et al. [16] for a discussion of the connection of data-flow analysis to Datalog.

The Metal code checker is described by Engler et al. [12] and the PREFIX checker was created by Bush, Pincus, and Sielaff [10]. Ball and Rajamani [4] developed a program analysis engine called SLAM using model checking and symbolic execution to simulate all possible behaviors of a system. Ball et al. [5] have created a static analysis tool called SDV based on SLAM to find API usage errors in C device-driver programs by applying BDD's to model checking.

Livshits and Lam [17] describe how context-sensitive points-to analysis can be used to find SQL vulnerabilities in Java web applications. Ruwase and Lam [20] describe how to keep track of array extents and insert dynamic bounds checks automatically. Rinard et al. [19] describe how to extend arrays dynamically to accommodate for the overflowed contents. Avots et al. [3] extend the context-sensitive Java points-to analysis to C and show how it can be used to reduce the cost of dynamic detection of buffer overflows.

1. Allen, F. E., "Interprocedural data flow analysis," *Proc. IFIP Congress 1974*, PP- 398-402, North Holland, Amsterdam, 1974.
2. Andersen, L., *Program Analysis and Specialization for the C Programming Language*, Ph.D. thesis, DIKU, Univ. of Copenhagen, Denmark, 1994.
3. Avots, D., M. Dalton, V. B. Livshits, and M. S. Lam, "Improving software security with a C pointer analysis," *ICSE 2005: Proc. 27th International Conference on Software Engineering*, pp. 332-341.
4. Ball, T. and S. K. Rajamani, "A symbolic model checker for boolean programs," *Proc. SPIN 2000 Workshop on Model Checking of Software*, pp. 113-130.
5. Ball, T., E. Bounimova, B. Cook, V. Levin, J. Lichtenber, C. McGarvey, B. Ondrusek, S. Rajamani, and A. Ustuner, "Thorough static analysis of device drivers," *EuroSys (2006)*, pp. 73-85.
6. Banning, J. P., "An efficient way to find the side effects of procedural calls and the aliases of variables," *Proc. Sixth Annual Symposium on Principles of Programming Languages (1979)*, pp. 29-41.
7. Barth, J. M., "A practical interprocedural data flow analysis algorithm," *Comm. ACM 21:9 (1978)*, pp. 724-736.
8. Berndt, M., O. Lohtak, F. Qian, L. Hendren, and N. Umanee, "Points-to analysis using BDD's," *Proc. ACM SIGPLAN 2003 Conference on Programming Language Design and Implementation*, pp. 103-114.
9. Bryant, R. E., "Graph-based algorithms for Boolean function manipulation," *IEEE Trans, on Computers C-35:8 (1986)*, pp. 677-691.

10. Bush, W. R., J. D. Pincus, and D. J. Sielaff, "A static analyzer for finding dynamic programming errors," *Software-Practice and Experience*, 30:7 (2000), pp. 775-802.
11. Callahan, D., K. D. Cooper, K. Kennedy, and L. Torczon, "Interprocedural constant propagation," *Proc. SIGPLAN 1986 Symposium on Compiler Construction*, *SIGPLAN Notices*, 21:7 (1986), pp. 152-161.
12. Engler, D., B. Chelf, A. Chou, and S. Hallem, "Checking system rules using system-specific, programmer-written compiler extensions," *Proc. Sixth USENIX Conference on Operating Systems Design and Implementation* (2000). pp. 1-16.
13. Emami, M., R. Ghiya, and L. J. Hendren, "Context-sensitive interprocedural points-to analysis in the presence of function pointers," *Proc. SIGPLAN Conference on Programming Language Design and Implementation* (1994), pp. 224-256.
14. Fahndrich, M., J. Rehof, and M. Das, "Scalable context-sensitive flow analysis using instantiation constraints," *Proc. SIGPLAN Conference on Programming Language Design and Implementation* (2000), pp. 253-263.
15. Heintze, N. and O. Tardieu, "'Ultra-fast aliasing analysis using CLA: a million lines of C code in a second," *Proc. of the SIGPLAN Conference on Programming Language Design and Implementation* (2001), pp. 254-263.
16. Lam, M. S., J. Whaley, V. B. Livshits, M. C. Martin, D. Avots, M. Carbin, and C. Unkel, "Context-sensitive program analysis as database queries," *Proc. 2005 ACM Symposium on Principles of Database Systems*, pp. 1-12.
17. Livshits, V. B. and M. S. Lam, "Finding security vulnerabilities in Java applications using static analysis" *Proc. 13th USENIX Security Symposium* (2005), pp. 271-286.
18. Milanova, A., A. Rountev, and B. G. Ryder, "Parameterized object sensitivity for points-to and side-effect analyses for Java" *Proc. 2002 ACM SIGSOFT International Symposium on Software Testing and Analysis*, pp. 1-11.
19. Rinard, M., C. Cadar, D. Dumitran, D. Roy, and T. Leu, "A dynamic technique for eliminating buffer overflow vulnerabilities (and other memory errors)," *Proc. 2004 Annual Computer Security Applications Conference*, pp. 82-90.
20. Ruwase, O. and M. S. Lam, "A practical dynamic buffer overflow detector," *Proc. 11th Annual Network and Distributed System Security Symposium* (2004), pp. 159-169.

21. Sharir, M. and A. Pnueli, "Two approaches to interprocedural data flow analysis," in S. Muchnick and N. Jones (eds.) *Program Flow Analysis: Theory and Applications*, Chapter 7, pp. 189-234. Prentice-Hall, Upper Saddle River NJ, 1981.
22. Steensgaard, B., "Points-to analysis in linear time," *Twenty-Third ACM Symposium on Principles of Programming Languages* (1996).
23. Ullman, J. D. and J. Widom, *A First Course in Database Systems*, Prentice-Hall, Upper Saddle River NJ, 2002.
24. Whaley, J. and M. S. Lam, "Cloning-based context-sensitive pointer alias analysis using binary decision diagrams," *Proc. ACM SIGPLAN 2004 Conference on Programming Language Design and Implementation*, pp. 131-144.
25. Zhu, J., "Symbolic Pointer Analysis," *Proc. International Conference in Computer-Aided Design* (2002), pp. 150-157.

# Appendix A

## A Complete Front End

The complete compiler front end in this appendix is based on the informally described simple compiler of Sections 2.5-2.8. The main difference from Chapter 2 is that the front end generates jumping code for boolean expressions, as in Section 6.6. We begin with the syntax of the source language, described by a grammar that needs to be adapted for top-down parsing.

The Java code for the translator consists of five packages: `main`, `lexer`, `symbol`, `parser`, and `inter`. Package `inter` contains classes for the language constructs in the abstract syntax. Since the code for the parser interacts with the rest of the packages, it will be discussed last. Each package is stored as a separate directory with a file per class.

Going into the parser, the source program consists of a stream of tokens, so object-orientation has little to do with the code for the parser. Coming out of the parser, the source program consists of a syntax tree, with constructs or nodes implemented as objects. These objects deal with all of the following: construct a syntax-tree node, check types, and generate three-address intermediate code (see package `inter`).

### A.1 The Source Language

A program in the language consists of a block with optional declarations and statements. Token `basic` represents basic types.

```
program  -> block
block    -> { decls stms }
decls   -> decls decl | e
decl    -> type id ;
type    -> type [ num ] | basic
stms    -> stms stmt | e
```

Treating assignments as statements, rather than as operators within expressions, simplifies translation.

## Object-Oriented Versus Phase-Oriented

With an object-oriented approach, all the code for a construct is collected in the class for the construct. Alternatively, with a phase-oriented approach, the code is grouped by phase, so a type checking procedure would have a case for each construct, and a code generation procedure would have a case for each construct, and so on.

The tradeoff is that an object-oriented approach makes it easier to change or add a construct, such as "for" statements, and a phase-oriented approach makes it easier to change or add a phase, such as type checking. With objects, a new construct can be added by writing a self-contained class, but a change to a phase, such as inserting code for coercions, requires changes across all the affected classes. With phases, a new construct can result in changes across the procedures for the phases.

```

stmt  ->  loc = bool ;
          |   if ( bool ) stmt
          |   if ( bool ) stmt else stmt
          |   while ( bool ) stmt
          |   do stmt while ( bool ) ;
          |   break ;
          |   / block
loc    ->• loc [ bool ] | id

```

The productions for expressions handle associativity and precedence of operators. They use a nonterminal for each level of precedence and a nonterminal, *factor*, for parenthesized expressions, identifiers, array references, and constants.

```

bool  -+  bool 1 1 join | join
join  -+  join kk equality | equality
equality -t  equality == rel \ equality != rel \ rel
          rel  expr < expr \ expr <= expr \ expr >= expr \
          expr  expr > expr J expr
          expr  expr + term \ expr - term \ term
term   ->  term * unary \ term / unary \ unary
unary  ->  ! unary \ - unary \ factor
factor ->  ( bool ) / loc | num | real | true | false

```

## A. 2 Main

Execution begins in method `main` in class `Main`. Method `main` creates a lexical analyzer and a parser and then calls method `program` in the parser:

```

1) package main;           // File Main.java
2) import java.io.*; import lexer.*; import parser.*;

```

```

3) public class Main {
4)     public static void main(String[] args) throws IOException {
5)         Lexer lex = new LexerQ;
6)         Parser parse = new Parser(lex);
7)         parse.program0;
8)         System.out.write('\n');
9)     } >
10) }

```

## A.3 Lexical Analyzer

Package `lexer` is an extension of the code for the lexical analyzer in Section 2.6.5. Class `Tag` defines constants for tokens:

```

1) package lexer;                // File Tag.java
2) public class Tag {
3)     public final static int
4)         AND = 256, BASIC = 257, BREAK = 258, DO = 259, ELSE = 260,
5)         EQ = 261, FALSE = 262, GE = 263; ID = 264, IF = 265,
6)         INDEX = 266, LE = 267, MINUS = 268, NE = 269, NUM = 270,
7)         OR >= 271, REAL = 272, TEMP = 273, TRUE = 274, WHILE = 275;

```

Three of the constants, `INDEX`, `MINUS`, and `TEMP`, are not lexical tokens; they will be used in syntax trees.

Classes `Token` and `Num` are as in Section 2.6.5, with method `toString` added:

```

1) package lexer;                // File Token.java
2) public class Token {
3)     public final int tag;
4)     public Token(int t) { tag = t; >
5)     public String toString() { return "" + (char)tag; }
6) } >

1) package lexer;                // File Num.java
2) public class Num extends Token {
3)     public final int value;
4)     public Num(int v) { super(Tag.NUM); value = v; }
5)     public String toString() { return "" + value; }
6) } 1

```

Class `Word` manages lexemes for reserved words, identifiers, and composite tokens like `kk`. It is also useful for managing the written form of operators in the intermediate code like unary minus; for example, the source text `-2` has the intermediate form `minus 2`.

```

1) package lexer;                // File Word.java
2) public class Word extends Token {
3)     public String lexeme = "";
4)     public WordCString s, int tag) { super(tag); lexeme = s; }
5)     public String toString() { return lexeme; }
6)     public static final Word
7)         and = new Word( "kk", Tag.AND ), or = new Word( "II", Tag.OR ),

```

```

8)      eq = new Word( "=", Tag.EQ ), ne = new Word( "!=", Tag.NE ),
9)      le = new Word( "<=", Tag.LE ), ge = new Word( ">=", Tag.GE ),
10)     minus = new Word( "minus", Tag.MINUS ),
11)     True = new Word( "true", Tag.TRUE ),
12)     False = new Word( "false", Tag.FALSE ),
13)     temp = new Word( "t", Tag.TEMP );
14) }

```

Class **Real** is for floating point numbers:

```

1) package lexer;                // File Real.java
2) public class Real extends Token *{
3)     public final float value;
4)     public Real(float v) { super(Tag.REAL); value = v; }
5)     public String toStringO { return "" + value; }
6) >

```

The main method in class **Lexer**, function **scan**, recognizes numbers, identifiers, and reserved words, as discussed in Section 2.6.5.

Lines 9-13 in class **Lexer** reserve selected keywords. Lines 14-16 reserve lexemes for objects defined elsewhere. Objects **Word.True** and **Word.False** are defined in class **Word**. Objects for the basic types **int**, **char**, **bool**, and **float** are defined in class **Type**, a subclass of **Word**. Class **Type** is from package **symbols**.

```

1) package lexer;                // File Lexer.java
2) import java.io.*; import java.util.*; import symbols.*;
3) public class Lexer {
4)     public static int line = 1;
5)     char peek = ' ';
6)     Hashtable words = new Hashtable();
7)     void reserve(Word w) { words.put(w.lexeme, w); }
8)     public Lexer() {
9)         reserve( new Word("if", Tag.IF) );
10)        reserve( new Word("else", Tag.ELSE) );
11)        reserve( new Word("while", Tag.WHILE) );
12)        reserve( new Word("do", Tag.DO) );
13)        reserve( new Word("break", Tag.BREAK) );
14)        reserve( Word.True ); reserve( Word.False );
15)        reserve( Type.Int ); reserve( Type.Char );
16)        reserve( Type.Bool ); reserve( Type.Float );
17)    }

```

Function **readchO** (line 18) is used to read the next input character into variable **peek**. The name **readch** is reused or overloaded (lines 19-24) to help recognize composite tokens. For example, once input **<** is seen, the call **readchO=>**) reads the next character into **peek** and checks whether it is **=**.

```

18) void readchO throws IOException { peek = (char)System.in.read(); }
19) boolean readch(char c) throws IOException {
20)     readchO;
21)     if( peek != c ) return false;
22)     peek = ' ';
23)     return true;
24) >

```

Function `scan` begins by skipping white space (lines 26-30). It recognizes composite tokens like `<=` (lines 31-44) and numbers like `365` and `3.14` (lines 45-58), before collecting words (lines 59-70).

```

25) public Token scan() throws IOException {
26)     for( ; ; readchO ) {
27)         if( peek == ' ' || peek == '\t' ) continue;
28)         else if( peek == '\n' ) line = line + 1;
29)         else break;
30)
31)         switchC peek ) {
32)             case ' ':
33)                 if( readchO &' ) return Word.and;   else return new Token('&'
34)             case 'I':
35)                 if( readchC |' ) return Word.or;     else return new Token('|'
36)             case '=':
37)                 if( readch('=' ) return Word.eq;    else return new Token('='
38)             case '!':
39)                 if( readch('=' ) return Word.ne;    else return new Token('!'
40)             case '<':
41)                 if( readch('=' ) return Word.le;    else return new Token('<'
42)             case '>':
43)                 if( readch('=' ) return Word.ge;    else return new Token('>'
44)         }
45)         if( Character.isDigit(peek) ) {
46)             int v = 0;
47)             do {
48)                 v = 10*v + Character.digit(peek, 10); readchO;
49)             } while( Character.isDigit(peek) );
50)             if( peek != '.' ) return new Num(v);
51)             float x = v; float d = 10;
52)             for(;;) {
53)                 readchO ;
54)                 if( ! Character.isDigit(peek) ) break;
55)                 x = x + Character.digit(peek, 10) / d; d = d*10;
56)             }
57)             return new Real(x);
58)         }
59)         if( Character.isLetter(peek) ) {
60)             StringBuffer b = new StringBuffer();
61)             do {
62)                 b.append(peek); readchO;
63)             } while( Character.isLetterOrDigit(peek) );
64)             String s = b.toStringO;
65)             Word w = (Word)words.get(s);
66)             if( w != null ) return w;
67)             w = new Word(s, Tag.ID);
68)             words.put(s, w);
69)             return w;
70)         }

```

Finally, any remaining characters are returned as tokens (lines 71-72).

```

71)     Token tok = new Token(peek); peek = ' ';
72)     return tok;
73) }
74) >

```



## A.4 Symbol Tables and Types

Package **symbols** implements symbol tables and types.

Class **Env** is essentially unchanged from Fig. 2.37. Whereas class **Lexer** maps strings to words, class **Env** maps word tokens to objects of class **Id**, which is defined in package **inter** along with the classes for expressions and statements.

```

1) package symbols;                // File Env.java
2) import java.util.*; import lexer.*; import inter.*;
3) public class Env {
4)     private Hashtable table;
5)     protected Env prev;
6)     public Env(Env n) { table = new HashtableO; prev = n; }
7)     public void put(Token w, Id i) { table.put(w, i); }
8)     public Id get(Token w) {
9)         for( Env e = this; e != null; e = e.prev ) {
10)             Id found = (Id)(e.table.get(w));
11)             if( found != null ) return found;
12)         }
13)         return null;
14)     }
15) }

```

We define class **Type** to be a subclass of **Word** since basic type names like **int** are simply reserved words, to be mapped from lexemes to appropriate objects by the lexical analyzer. The objects for the basic types are **Type.Int**, **Type.Float**, **Type.Char**, and **Type.Bool** (lines 7-10). All of them have inherited field **tag** set to **Tag.BASIC**, so the parser treats them all alike.

```

1) package symbols;                // File Type.java
2) import lexer.*;
3) public class Type extends Word {
4)     public int width = 0;        // width is used for storage allocation
5)     public Type(String s, int tag, int w) { super(s, tag); width = w; }
6)     public static final Type
7)         Int    = new Type( "int",   Tag.BASIC, 4 ),
8)         Float  = new Type( "float", Tag.BASIC, 8 ),
9)         Char   = new Type( "char",  Tag.BASIC, 1 ),
10)        Bool   = new Type( "bool",  Tag.BASIC, 1 );

```

Functions **numeric** (lines 11-14) and **max** (lines 15-20) are useful for type conversions.

```

11) public static boolean numeric(Type p) {
12)     if ( p == Type.Char || p == Type.Int || p == Type.Float ) return true;
13)     else return false;
14) }
15) public static Type max(Type p1, Type p2 ) {
16)     if ( ! numeric(p1) || ! numeric(p2) ) return null;
17)     else if ( p1 == Type.Float || p2 == Type.Float ) return Type.Float;
18)     else if ( p1 == Type.Int   || p2 == Type.Int   ) return Type.Int;
19)     else return Type.Char;
20) }
21) }

```

Conversions are allowed between the "numeric" types `Type.Char`, `Type.Int`, and `Type.Float`. When an arithmetic operator is applied to two numeric types, the result is the "max" of the two types.

Arrays are the only constructed type in the source language. The call to `super` on line 7 sets field `width`, which is essential for address calculations. It also sets `lexeme` and `tok` to default values that are not used.

```

1) package symbols;           // File Array.java
2) import lexer.*;
3) public class Array extends Type {
4)     public Type of;         // array *of* type
5)     public int size = 1;    // number of elements
6)     public Array(int sz, Type p) {
7)         super("[", Tag.INDEX, sz*p.width); size = sz; of = p;
8)     }
9)     public String toStringO { return "[" + size + "]" + of.toStringO; }
10) }

```

## A.5 Intermediate Code for Expressions

Package `inter` contains the `Node` class hierarchy. `Node` has two subclasses: `Expr` for expression nodes and `Stmt` for statement nodes. This section introduces `Expr` and its subclasses. Some of the methods in `Expr` deal with booleans and jumping code; they will be discussed in Section A.6, along with the remaining subclasses of `Expr`.

Nodes in the syntax tree are implemented as objects of class `Node`. For error reporting, field `lexline` (line 4, file `Node.java`) saves the source-line number of the construct at this node. Lines 7-10 are used to emit three-address code.

```

1) package inter;             // File Node.java
2) import lexer.*;
3) public class Node {
4)     int lexline = 0;
5)     Node() { lexline = Lexer.line; }
6)     void error(String s) { throw new Error("near line "+lexline+": "+s); }
7)     static int labels = 0;
8)     public int newlabelO -[ return ++labels; }
9)     public void emitlabel(int i) { System.out.print("L" + i + " : " ); }
10)    public void emit(String s) { System.out.println("\t" + s); }
11) }

```

Expression constructs are implemented by subclasses of `Expr`. Class `Expr` has fields `op` and `type` (lines 4-5, file `Expr.java`), representing the operator and type, respectively, at a node.

```

1) package inter;           // File Expr.java
2) import lexer.*; import symbols.*;
3) public class Expr extends Node {
4)     public Token op;
5)     public Type type;
6)     Expr(Token tok, Type p) { op = tok; type = p; }

```

Method **gen** (line 7) returns a "term" that can fit the right side of a three-address instruction. Given expression  $E = E_1 + E_2$ , method **gen** returns a term  $x_1 + x_2$ , where  $x_1$  and  $x_2$  are addresses for the values of  $E_1$  and  $E_2$ , respectively. The return value **this** is appropriate if this object is an address; subclasses of **Expr** typically reimplement **gen**.

Method **reduce** (line 8) computes or "reduces" an expression down to a single address; that is, it returns a constant, an identifier, or a temporary name. Given expression  $E$ , method **reduce** returns a temporary  $t$  holding the value of  $E$ . Again, **this** is an appropriate return value if this object is an address.

We defer discussion of methods **jumping** and **emit jumps** (lines 9-18) until Section A.6; they generate jumping code for boolean expressions.

```

7)  public Expr gen() { return this; >
8)  public Expr reduce() { return this; }
9)  public void jumping(int t, int f) { emitjumps(toStringO, t, f); }
10) public void emitjumps(String test, int t, int f) {
11)     if( t != 0 && f != 0 ) {
12)         emit("if " + test + " goto L" + t);
13)         emit("goto L" + f);
14)     }
15)     else if( t != 0 ) emit("if " + test + " goto L" + t);
16)     else if( f != 0 ) emit("iffalse " + test + " goto L" + f);
17)     else ; // nothing since both t and f fall through
18) }
19) public String toStringO { return op.toStringO; >
20) }

```

Class **Id** inherits the default implementations of **gen** and **reduce** in class **Expr**, since an identifier is an address.

```

1) package inter; // File Id.java
2) import lexer.*; import symbols.*;
3) public class Id extends Expr {
4)     public int offset; // relative address
5)     public Id(Word id, Type p, int b) { super(id, p); offset = b; }
6) >

```

The node for an identifier of class **Id** is a leaf. The call **super(id,p)** (line 5, file *Id.java*) saves **id** and **p** in inherited fields **op** and **type**, respectively. Field **offset** (line 4) holds the relative address of this identifier.

Class **Op** provides an implementation of **reduce** (lines 5-10, file *Op.java*) that is inherited by subclasses **Arith** for arithmetic operators, **Unary** for unary operators, and **Access** for array accesses. In each case, **reduce** calls **gen** to generate a term, emits an instruction to assign the term to a new temporary name, and returns the temporary.

```

1) package inter; // File Op.java
2) import lexer.*; import symbols.*;
3) public class Op extends Expr {
4)     public Op(Token tok, Type p) { super(tok, p); }
5)     public Expr reduce() {
6)         Expr x = gen();

```

```

7)      Temp t = new Temp(type);
8)      emit( t.toStringO + " = " + x.toStringO );
9)      return t;
10)   }
11) }

```

Class **Arith** implements binary operators like + and \*. Constructor **Arith** begins by calling **super(tok, null)** (line 6), where **tok** is a token representing the operator and **null** is a placeholder for the type. The type is determined on line 7 by using **Type.max**, which checks whether the two operands can be coerced to a common numeric type; the code for **Type.max** is in Section A.4. If they can be coerced, **type** is set to the result type; otherwise, a type error is reported (line 8). This simple compiler checks types, but it does not insert type conversions.

```

1) package inter;                // File Arith.java
2) import lexer.*; import symbols.*;
3) public class Arith extends Op {
4)   public Expr expr1, expr2;
5)   public Arith(Token tok, Expr x1, Expr x2) {
6)     super(tok, null); expr1 = x1; expr2 = x2;
7)     type = Type.max(expr1.type, expr2.type);
8)     if (type == null ) error("type error");
9)   }
10)  public Expr gen() •[
11)    return new Arith(op, expr1.reduce(), expr2.reduce());
12)  }
13)  public String toStringO {
14)    return expr1.toString()+" "+op.toString()+" "+expr2.toStringO;
15)  }
16) }

```

Method **gen** constructs the right side of a three-address instruction by reducing the subexpressions to addresses and applying the operator to the addresses (line 11, file *Arith.java*). For example, suppose **gen** is called at the root for **a+b\*c**. The calls to **reduce** return **a** as the address for subexpression **a** and a temporary **t** as the address for **b\*c**. Meanwhile, **reduce** emits the instruction **t=b\*c**. Method **gen** returns a new **Arith** node, with operator \* and addresses **a** and **t** as operands.<sup>1</sup>

It is worth noting that temporary names are typed, along with all other expressions. The constructor **Temp** is therefore called with a type as a parameter (line 6, file *Temp.java*).<sup>2</sup>

```

1) package inter;                // File Temp.java
2) import lexer.*; import symbols.*;
3) public class Temp extends Expr {

```

<sup>1</sup>For error reporting, field *lexline* in class *Node* records the current lexical line number when a node is constructed. We leave it to the reader to track line numbers when new nodes are constructed during intermediate code generation.

<sup>2</sup>An alternative approach might be for the constructor to take an expression node as a parameter, so it can copy the type and lexical position of the expression node.

```

4)  static int count = 0;
5)  int number = 0;
6)  public Temp(Type p) { super(Word.temp, p); number = ++count; }
7)  public String toStringO { return "t" + number; }
8)>

```

Class **Unary** is the one-operand counterpart of class **Arith**:

```

1) package inter;           // File Unary.java
2) import lexer.*; import symbols.*;
3) public class Unary extends Op {
4)   public Expr expr;
5)   public Unary(Token tok, Expr x) { // handles minus, for ! see Not
6)     super(tok, null); expr = x;
7)     type = Type.max(Type.Int, expr.type);
8)     if (type == null ) error("type error");
9)   }
10)  public Expr gen() { return new Unary(op, expr.reduce()); }
11)  public String toStringO { return op.toString()+" "+expr.toStringO; }
12) }

```

## A.6 Jumping Code for Boolean Expressions

Jumping code for a boolean expression  $B$  is generated by method jumping, which takes two labels  $t$  and  $f$  as parameters, called the true and false exits of  $B$ , respectively. The code contains a jump to  $t$  if  $B$  evaluates to true, and a jump to  $f$  if  $B$  evaluates to false. By convention, the special label  $0$  means that control falls through  $B$  to the next instruction after the code for  $B$ .

We begin with class **Constant**. The constructor **Constant** on line 4 takes a token  $tok$  and a type  $p$  as parameters. It constructs a leaf in the syntax tree with label  $tok$  and type  $p$ . For convenience, the constructor **Constant** is overloaded (line 5) to create a constant object from an integer.

```

1) package inter;           // File Constant.java
2) import lexer.*; import symbols.*;
3) public class Constant extends Expr {
4)   public Constant(Token tok, Type p) { super(tok, p); }
5)   public Constant(int i) { super(new Num(i), Type.Int); }
6)   public static final Constant
7)     True = new Constant(Word.True, Type.Bool),
8)     False = new Constant(Word.False, Type.Bool);
9)   public void jumping(int t, int f) {
10)    if ( this == True && t != 0 ) emit("goto L" + t);
11)    else if ( this == False && f != 0 ) emit("goto L" + f);
12)  }
13) }

```

Method jumping (lines 9-12, file *Constant.java*) takes two parameters, labels  $t$  and  $f$ . If this constant is the static object **True** (defined on line 7) and  $t$  is not the special label  $0$ , then a jump to  $t$  is generated. Otherwise, if this is the object **False** (defined on line 8) and  $f$  is nonzero, then a jump to  $f$  is generated.

Class `Logical` provides some common functionality for classes `Or`, `And`, and `Not`. Fields `x` and `y` (line 4) correspond to the operands of a logical operator. (Although class `Not` implements a unary operator, for convenience, it is a subclass of `Logical`.) The constructor `Logical(tok, a, b)` (lines 5-10) builds a syntax node with operator `tok` and operands `a` and `b`. In doing so it uses function `check` to ensure that both `a` and `b` are booleans. Method `gen` will be discussed at the end of this section.

```

1) package inter;                // File Logical.java
2) import lexer.*; import symbols.*;
3) public class Logical extends Expr {
4)     public Expr expr1, expr2;
5)     Logical(Token tok, Expr x1, Expr x2) {
6)         super(tok, null);                // null type to start
7)         expr1 = x1; expr2 = x2;
8)         type = check(expr1.type, expr2.type);
9)         if (type == null ) error("type error");
10)    }
11)    public Type check(Type p1, Type p2) {
12)        if ( p1 == Type.Bool && p2 == Type.Bool ) return Type.Bool;
13)        else return null;
14)    }
15)    public Expr gen() {
16)        int f = newlabelQ; int a = newlabelQ;
17)        Temp temp = new Temp(type);
18)        this.jumping(0,f);
19)        emit(temp.toStringQ + " = true");
20)        emit("goto L" + a);
21)        emitlabel(f); emit(temp.toStringQ + " = false");
22)        emitlabel(a);
23)        return temp;
24)    }
25)    public String toStringQ {
26)        return expr1.toString()+" "+op.toString()+" "+expr2.toStringQ;
27)    }
28) }

```

In class `Or`, method `jumping` (lines 5-10) generates jumping code for a boolean expression  $B = B_1 \setminus B_2$ . For the moment, suppose that neither the true exit `t` nor the false exit `f` of `B` is the special label 0. Since `B` is true if `B1` is true, the true exit of `B1` must be `t` and the false exit corresponds to the first instruction of `B2`. The true and false exits of `B2` are the same as those of `B`.

```

1) package inter;                // File Or.java
2) import lexer.*; import symbols.*;
3) public class Or extends Logical {
4)     public Or(Token tok, Expr x1, Expr x2) { super(tok, x1, x2); }
5)     public void jumping(int t, int f) {
6)         int label = t != 0 ? t : newlabel();
7)         expr1.jumping(label, 0);
8)         expr2.jumping(t,f);
9)         if( t == 0 ) emitlabel(label);
10)    }
11) }

```

In the general case,  $t$ , the true exit of  $B$ , can be the special label 0. Variable `label` (line 6, file `Or.java`) ensures that the true exit of  $B_i$  is set properly to the end of the code for  $B$ . If  $t$  is 0, then `label` is set to a new label that is emitted after code generation for both  $B\setminus$  and  $B$ .

The code for class `And` is similar to the code for `Or`.

```

1) package inter;                               // File And.java
2) import lexer.*; import symbols.*;
3) public class And extends Logical {
4)   public And(Token tok, Expr x1, Expr x2) { super(tok, x1, x2); }
5)   public void jumping(int t, int f) {
6)     int label = f != 0 ? f : newlabel();
7)     expr1.jumping(0, label);
8)     expr2.jumping(t,f);
9)     if( f == 0 ) emitlabel(label);
10)  }
11) >

```

Class `Not` has enough in common with the other boolean operators that we make it a subclass of `Logical`, even though `Not` implements a unary operator. The superclass expects two operands, so `b` appears twice in the call to `super` on line 4. Only `y` (declared on line 4, file `Logical.java`) is used in the methods on lines 5-6. On line 5, method `jumping` simply calls `y.jumping` with the true and false exits reversed.

```

1) package inter;                               // File Not.java
2) import lexer.*; import symbols.*;
3) public class Not extends Logical {
4)   public Not(Token tok, Expr x2) { super(tok, x2, x2); >
5)   public void jumping(int t, int f) { expr2.jumping(f, t); }
6)   public String toStringO { return op.toString()+" "+expr2.toStringO; }
7) >

```

Class `Rel` implements the operators `<`, `<=`, `==`, `!=`, `>=`, and `>`. Function `check` (lines 5-9) checks that the two operands have the same type and that they are not arrays. For simplicity, coercions are not permitted.

```

1) package inter;                               // File Rel.java
2) import lexer.*; import symbols.*;
3) public class Rel extends Logical {
4)   public ReKToken tok, Expr x1, Expr x2) { super(tok, x1, x2); }
5)   public Type check(Type p1, Type p2) {
6)     if ( p1 instanceof Array || p2 instanceof Array ) return null;
7)     else if( p1 == p2 ) return Type.Bool;
8)     else return null;
9)   >
10)  public void jumping(int t, int f) {
11)    Expr a = expr1.reduce();
12)    Expr b = expr2.reduce();
13)
14)    String test = a.toStringO + " " + op.toStringO + " " + b.toStringO;
15)    emitjumps(test, t, f);
16)  }

```

Method jumping (lines 10-15, file *Rel.Java*) begins by generating code for the subexpressions *x* and *y* (lines 11-12). It then calls method *emitjumps* defined on lines 10-18, file *Expr.java*, in Section A.5. If neither *t* nor *f* is the special label 0, then *emitjumps* executes the following

```
12)          emit("if " + test + " goto L" + t);          // File Expr.java
13)          emit("goto L" + f);
```

At most one instruction is generated if either *t* or *f* is the special label 0 (again, from file *Expr.java*):

```
15)          else if( t != 0 ) emitC'if " + test + " goto L" + t);
16)          else if( f != 0 ) emitC'iffalse " + test + " goto L" + f);
17)          else ; // nothing since both t and f fall through
```

For another use of *emitjumps*, consider the code for class *Access*. The source language allows boolean values to be assigned to identifiers and array elements, so a boolean expression can be an array access. Class *Access* has method *gen* for generating "normal" code and method jumping for jumping code. Method jumping (line 11) calls *emitjumps* after reducing this array access to a temporary. The constructor (lines 6-9) is called with a flattened array *a*, an index *i*, and the type *p* of an element in the flattened array. Type checking is done during array address calculation.

```
1) package inter;          // File Access.Java
2) import lexer.*; import symbols.*;
3) public class Access extends Op {
4)   public Id array;
5)   public Expr index;
6)   public Access(Id a, Expr i, Type p) { // p is element type after
7)     super(new Word("[]", Tag.INDEX), p); // flattening the array
8)     array = a; index = i;
9)   }
10)  public Expr gen() { return new Access(array, index.reduce(), type); }
11)  public void jumping(int t,int f) { emitjumps(reduce().toStringO,t,f); }
12)  public String toStringO {
13)    return array.toStringO + " [ " + index.toStringO + " ]";
14)  }
15) }
```

Jumping code can also be used to return a boolean value. Class *Logical*, earlier in this section, has a method *gen* (lines 15-24) that returns a temporary *temp*, whose value is determined by the flow of control through the jumping code for this expression. At the true exit of this boolean expression, *temp* is assigned true; at the false exit, *temp* is assigned false. The temporary is declared on line 17. Jumping code for this expression is generated on line 18 with the true exit being the next instruction and the false exit being a new label *f*. The next instruction assigns true to *temp* (line 19), followed by a jump to a new label *a* (line 20). The code on line 21 emits label *f* and an instruction that assigns false to *temp*. The code fragment ends with label *a*, generated on line 22. Finally, *gen* returns *temp* (line 23).



## A.7 Intermediate Code for Statements

Each statement construct is implemented by a subclass of Stmt. The fields for the components of a construct are in the relevant subclass; for example, class While has fields for a test expression and a substatement, as we shall see.

Lines 3-4 in the following code for class Stmt deal with syntax-tree construction. The constructor StmtO does nothing, since the work is done in the subclasses. The static object Stmt.Null (line 4) represents an empty sequence of statements.

```

1) package inter;                // File Stmt.Java
2) public class Stmt extends Node {
3)   public StmtO { }
4)   public static Stmt Null = new StmtO;
5)   public void gen(int b, int a) O // called with labels begin and after
6)   int after =0;                // saves label after
7)   public static Stmt Enclosing = Stmt.Null; // used for break stmts
8)>

```

Lines 5-7 deal with the generation of three-address code. The method gen is called with two labels b and a, where b marks the beginning of the code for this statement and a marks the first instruction after the code for this statement. Method gen (line 5) is a placeholder for the gen methods in the subclasses. The subclasses While and Do save their label a in the field after (line 6) so it can be used by any enclosed break statement to jump out of its enclosing construct. The object Stmt.Enclosing is used during parsing to keep track of the enclosing construct. (For a source language with continue statements, we can use the same approach to keep track of the enclosing construct for a continue statement.)

The constructor for class If builds a node for a statement **if** (*E*) *S*. Fields expr and stmt hold the nodes for *E* and *S*, respectively. Note that expr in lower-case letters names a field of class Expr; similarly, stmt names a field of class Stmt.

```

1) package inter;                // File If.Java
2) import symbols.*;
3) public class If extends Stmt {
4)   Expr expr; Stmt stmt;
5)   public If(Expr x, Stmt s) {
6)     expr = x; stmt = s;
7)     if( expr.type != Type.Bool ) expr.error("boolean required in if");
8)   }
9)   public void gen(int b, int a) {
10)    int label = newlabelO; // label for the code for stmt
11)    expr.jumping(0, a);    // fall through on true, goto a on false
12)    emitlabel(label); stmt.gen(label, a);
13)  }
14) }

```

The code for an If object consists of jumping code for expr followed by the code for stmt. As discussed in Section A.6, the call expr.jumping(0,f) on line

11 specifies that control must fall through the code for **expr** if **expr** evaluates to true, and must flow to label **a** otherwise.

The implementation of class **Else**, which handles conditionals with else parts, is analogous to that of class **If**:

```

1) package inter;                // File Else.java
2) import symbols.*;
3) public class Else extends Stmt {
4)     Expr expr; Stmt stmt1, stmt2;
5)     public Else(Expr x, Stmt s1, Stmt s2) {
6)         expr = x; stmt1 = s1; stmt2 = s2;
7)         if( expr.type != Type.Bool ) expr.error("boolean required in if");
8)     }
9)     public void gen(int b, int a) {
10)        int label1 = newlabel0; // label1 for stmt1
11)        int label2 = newlabel0; // label2 for stmt2
12)        expr.jumping(0,label2); // fall through to stmt1 on true
13)        emitlabel(label1); stmt1.gen(label1, a); emit("goto L" + a);
14)        emitlabel(label2); stmt2.gen(label2, a);
15)    }
16) >

```

The construction of a **While** object is split between the constructor **While()**, which creates a node with null children (line 5), and an initialization function **init(x,s)**, which sets child **expr** to **x** and child **stmt** to **s** (lines 6-9). Function **gen(b,a)** for generating three-address code (line 10-16) is in the spirit of the corresponding function **gen()** in class **If**. The difference is that label **a** is saved in field **after** (line 11) and that the code for **stmt** is followed by a jump to **b** (line 15) for the next iteration of the while loop.

```

1) package inter;                // File While.java
2) import symbols.*;
3) public class While extends Stmt *{
4)     Expr expr; Stmt stmt;
5)     public WhileO *{ expr = null; stmt = null; >
6)     public void init(Expr x, Stmt s) {
7)         expr = x; stmt = s;
8)         if( expr.type != Type.Bool ) expr.error("boolean required in while");
9)     >
10)    public void gen(int b, int a) {
11)        after = a; // save label a
12)        expr.jumping(0, a);
13)        int label = newlabel0; // label for stmt
14)        emitlabel(label); stmt.gen(label, b);
15)        emit("goto L" + b);
16)    > }

```

Class **Do** is very similar to class **While**.

```

1) package inter;                // File Do.java
2) import symbols.*;
3) public class Do extends Stmt *{
4)     Expr expr; Stmt stmt;

```

```

5) public Do() { expr = null; stmt = null; }
6) public void init(Stmt s, Expr x) •{
7)     expr = x; stmt = s;
8)     if( expr.type != Type.Bool ) expr.error("boolean required in do");
9) >
10) public void gen(int b, int a) {
11)     after = a;
12)     int label = newlabel0; // label for expr
13)     stmt.gen(b,label);
14)     emitlabel(label);
15)     expr.jumping(b,0);
16) >
17) >

```

Class Set implements assignments with an identifier on the left side and an expression on the right. Most of the code in class Set is for constructing a node and checking types (lines 5-13). Function gen emits a three-address instruction (lines 14-16).

```

1) package inter; // File Set.java
2) import lexer.*; import symbols.*;
3) public class Set extends Stmt {
4)     public Id id; public Expr expr;
5)     public Set(Id i, Expr x) {
6)         id = i; expr = x;
7)         if ( check(id.type, expr.type) == null ) error("type error");
8)     }
9)     public Type check(Type p1, Type p2) {
10)        if ( Type.numeric(p1) && Type.numeric(p2) ) return p2;
11)        else if ( p1 == Type.Bool && p2 == Type.Bool ) return p2;
12)        else return null;
13)    } >
14)    public void gen(int b, int a) {
15)        emit( id.toStringO + " = " + expr.gen().toStringO );
16)    }
17) >

```

Class SetElem implements assignments to an array element:

```

1) package inter; // File SetElem.java
2) import lexer.*; import symbols.*;
3) public class SetElem extends Stmt {
4)     public Id array; public Expr index; public Expr expr;
5)     public SetElem(Access x, Expr y) {
6)         array = x.array; index = x.index; expr = y;
7)         if ( check(x.type, expr.type) == null ) errorC("type error");
8)     } >
9)     public Type check(Type p1, Type p2) •{
10)        if ( p1 instanceof Array || p2 instanceof Array ) return null;
11)        else if ( p1 == p2 ) return p2;
12)        else if ( Type.numeric(p1) && Type.numeric(p2) ) return p2;
13)        else return null;
14)    }
15)    public void gen(int b, int a) •{
16)        String s1 = index.reduce().toStringO;
17)        String s2 = expr.reduce().toStringO;

```

```

18)     emit(array.toStringO + " [ " + si + " ] = " + s2);
19) >
20) }

```

Class **Seq** implements a sequence of statements. The tests for null statements on lines 6-7 are for avoiding labels. Note that no code is generated for the null statement, **Stmt.Null**, since method **gen** in class **Stmt** does nothing.

```

1) package inter;           // File Seq.java
2) public class Seq extends Stmt {
3)     Stmt stmt1; Stmt stmt2;
4)     public Seq(Stmt s1, Stmt s2) { stmt1 = s1; stmt2 = s2; >
5)     public void gen(int b, int a) {
6)         if ( stmt1 == Stmt.Null ) stmt2.gen(b, a);
7)         else if ( stmt2 == Stmt.Null ) stmt1.gen(b, a);
8)         else {
9)             int label = newlabelO;
10)            stmt1.gen(b,label);
11)            emitlabel(label);
12)            stmt2.gen(label,a);
13)        >
14)    }
15) }

```

A break statement sends control out of an enclosing loop or switch statement. Class **Break** uses field **stmt** to save the enclosing statement construct (the parser ensures that **Stmt.Enclosing** denotes the syntax-tree node for the enclosing construct). The code for a **Break** object is a jump to the label **stmt.after**, which marks the instruction immediately after the code for **stmt**.

```

1) package inter;           // File Break.java
2) public class Break extends Stmt {
3)     Stmt stmt;
4)     public Break() {
5)         if( Stmt.Enclosing == null ) error("unenclosed break");
6)         stmt = Stmt.Enclosing;
7)     >
8)     public void gen(int b, int a) {
9)         emit( "goto L" + stmt.after);
10)    }
11) >

```

## A. 8 Parser

The parser reads a stream of tokens and builds a syntax tree by calling the appropriate constructor functions from Sections A.5-A.7. The current symbol table is maintained as in the translation scheme in Fig. 2.38 in Section 2.7.

Package **parser** contains one class, **Parser**:

```

1) package parser;           // File Parser.java
2) import java.io.*; import lexer.*; import symbols.*; import inter.*;

```

```

3) public class Parser {
4)   private Lexer lex;      // lexical analyzer for this parser
5)   private Token look;    // lookahead token
6)   Env top = null;        // current or top symbol table
7)   int used = 0;          // storage used for declarations
8)   public Parser(Lexer l) throws IOException { lex = l; move(); }
9)   void move() throws IOException { look = lex.scanQ; }
10)  void error(String s) { throw new Error("near line "+lex.line+": "+s); }
11)  void match(int t) throws IOException {
12)      if( look.tag == t ) moveQ;
13)      else error("syntax error");
14)  }

```

Like the simple expression translator in Section 2.5, class `Parser` has a procedure for each nonterminal. The procedures are based on a grammar formed by removing left recursion from the source-language grammar in Section A.1.

Parsing begins with a call to procedure `program`, which calls `block()` (line 16) to parse the input stream and build the syntax tree. Lines 17-18 generate intermediate code.

```

15)  public void programQ throws IOException { // program -> block
16)      Stmt s = blockQ;
17)      int begin = s.newlabelQ;  int after = s.newlabelQ;
18)      s.emitlabel(begin); s.gen(begin, after); s.emitlabel(after);
19)  }

```

Symbol-table handling is shown explicitly in procedure `block`.<sup>3</sup> Variable `top` (declared on line 5) holds the top symbol table; variable `savedEnv` (line 21) is a link to the previous symbol table.

```

20)  Stmt blockQ throws IOException { // block -> { decls stmts }
21)      match('-C'); Env savedEnv = top; top = new Env(top);
22)      decls(); Stmt s = stmts();
23)      match(')'); top = savedEnv;
24)      return s;
25)  }

```

Declarations result in symbol-table entries for identifiers (see line 36). Although not shown here, declarations can also result in instructions to reserve storage for the identifiers at run time.

```

26)  void decls() throws IOException {
27)      while( look.tag == Tag.BASIC ) { // D -> type ID ;
28)          Type p = type(); Token tok = look; match(Tag.ID); matchC(';');
29)          Id id = new Id((Word)tok, p, used);
30)          top.put( tok, id );
31)          used = used + p.width;
32)      }
33)  }
34)  Type type() throws IOException {
35)      Type p = (Type)look; // expect look.tag == Tag.BASIC

```

<sup>3</sup>An attractive alternative is to add methods `push` and `pop` to class `Env`, with the current table accessible through a static variable `Env.top`

```

36)     match(Tag.BASIC);
37)     if( look.tag != '[' ) return p; // T -> basic
38)     else return dims(p);           // return array type
39) }
40) Type dims(Type p) throws IOException {
41)     match('['); Token tok = look; match(Tag.NUM); match(']');
42)     if( look.tag == '[' )
43)         p = dims(p);
44)     return new Array(((Mum)tok).value, p);
45) }

```

Procedure `stmt` has a switch statement with cases corresponding to the productions for nonterminal *Stmt*. Each case builds a node for a construct, using the constructor functions discussed in Section A.7. The nodes for while and do statements are constructed when the parser sees the opening keyword. The nodes are constructed before the statement is parsed to allow any enclosed break statement to point back to its enclosing loop. Nested loops are handled by using variable `Stmt.Enclosing` in class `Stmt` and `savedStmt` (declared on line 52) to maintain the current enclosing loop.

```

46) Stmt stmts() throws IOException {
47)     if ( look.tag == '}' ) return Stmt.Null;
48)     else return new Seq(stmt(), stmtsO);
49) }
50) Stmt stmt() throws IOException {
51)     Expr x; Stmt s, si, s2;
52)     Stmt savedStmt;           // save enclosing loop for breaks
53)     switch( look.tag ) {
54)     case ';':
55)         move();
56)         return Stmt.Null;
57)     case Tag.IF:
58)         match(Tag.IF); match('('); x = boolQ; match(')');
59)         si = stmt();
60)         if( look.tag != Tag.ELSE ) return new If(x, si);
61)         match(Tag.ELSE);
62)         s2 = stmt();
63)         return new Else(x, si, s2);
64)     case Tag.WHILE:
65)         While whilenode = new While();
66)         savedStmt = Stmt.Enclosing; Stmt.Enclosing = whilenode;
67)         match(Tag.WHILE); match('('); x = boolQ; match(')');
68)         si = stmt();
69)         whilenode.init(x, si);
70)         Stmt.Enclosing = savedStmt; // reset Stmt.Enclosing
71)         return whilenode;
72)     case Tag.DO:
73)         Do donode = new Do();
74)         savedStmt = Stmt.Enclosing; Stmt.Enclosing = donode;
75)         match(Tag.DO);
76)         si = stmtO;
77)         match(Tag.WHILE); match('('); x = bool(); match(')'); matchC(';');
78)         donode.init(si, x);
79)         Stmt.Enclosing = savedStmt; // reset Stmt.Enclosing
80)         return donode;

```

```

81)     case Tag.BREAK:
82)         match(Tag.BREAK); match(';');
83)         return new BreakO ;
84)     case '{ ':
85)         return blockO;
86)     default:
87)         return assignO;
88)     >

```

For convenience, the code for assignments appears in an auxiliary procedure, `assign.`'

```

90)     Stmt assignO throws IOException *f
91)         Stmt stmt; Token t = look;
92)         match(Tag.ID);
93)         Id id = top.get(t);
94)         if( id == null ) error(t.toStringO + " undeclared");
95)         if( look.tag == '>=' ) {           // S -> id = E ;
96)             move();  stmt = new Set(id, boolO);
97)         }
98)         else {                               // S -> L = E ;
99)             Access x = offset(id);
100)            match('=');  stmt = new SetElem(x, bool());
101)        >
102)        matchC(';');
103)        return stmt;
104)    }

```

The parsing of arithmetic and boolean expressions is similar. In each case, an appropriate syntax-tree node is created. Code generation for the two is different, as discussed in Sections A.5-A.6.

```

105)    Expr boolO throws IOException {
106)        Expr x = joinO;
107)        while( look.tag == Tag.OR ) {
108)            Token tok = look;  move();  x = new Or(tok, x, joinO);
109)        }
110)        return x;
111)    >
112)    Expr joinO throws IOException {
113)        Expr x = equalityO;
114)        while( look.tag == Tag.AND ) {
115)            Token tok = look;  move();  x = new And(tok, x, equalityO);
116)        }
117)        return x;
118)    >
119)    Expr equalityO throws IOException {
120)        Expr x = rel();
121)        while( look.tag == Tag.EQ II look.tag == Tag.NE ) {
122)            Token tok = look;  moveO;  x = new Rel(tok, x, rel());
123)        }
124)        return x;
125)    }
126)    Expr rel() throws IOException {
127)        Expr x = expr();

```

```

128)     switch( look.tag ) {
129)     case '<': case Tag.LE: case Tag.GE: case '>':
130)         Token tok = look;  move();  return new Rel(tok, x, exprO);
131)     default:
132)         return x;
133)     >
134) >
135) Expr exprQ throws IOException {
136)     Expr x = term();
137)     while( look.tag == '+' || look.tag == '-' ) {
138)         Token tok = look;  move();  x = new Arith(tok, x, termO);
139)     >
140)     return x;
141) }
142) Expr termO throws IOException {
143)     Expr x = unary();
144)     while(look.tag == '*' || look.tag == '/') {
145)         Token tok = look;  move();  x = new Arith(tok, x, unaryO);
146)     }
147)     return x;
148) >
149) Expr unaryO throws IOException {
150)     if( look.tag == '-' ) {
151)         move();  return new Unary(Word,minus, unaryO);
152)     }
153)     else if( look.tag == '\\' ) {
154)         Token tok = look;  moveQ;  return new Mot(tok, unaryO);
155)     >
156)     else return factor();
157) }

```

The rest of the code in the parser deals with "factors" in expressions. The auxiliary procedure `offset` generates code for array address calculations, as discussed in Section 6.4.3.

```

158) Expr factor() throws IOException {
159)     Expr x = null;
160)     switch( look.tag ) {
161)     case '(':
162)         move(); x = bool(); match('(');
163)         return x;
164)     case Tag.NUM:
165)         x = new Constant(look, Type.Int);  move(); return x;
166)     case Tag.REAL:
167)         x = new Constant(look, Type.Float); move(); return x;
168)     case Tag.TRUE:
169)         x = Constant.True;  move(); return x;
170)     case Tag.FALSE:
171)         x = Constant.False;  move(); return x;
172)     default:
173)         error("syntax error");
174)         return x;
175)     case Tag.ID:
176)         String s = look.toStringO ;
177)         Id id = top.get(look);
178)         if( id == null ) error(look.toString(); + " undeclared");

```



```

179)         moveQ;
180)         if( look.tag != '[' ) return id;
181)         else return offset(id);
182)     }
183) }
184) Access offset(Id a) throws IOException { // I -> [E] I [E] I
185)     Expr i; Expr w; Expr t1, t2; Expr loc; // inherit id
186)     Type type = a.type;
187)     matchCC; i = bool0; match(''); // first index, I -> [ E ]
188)     type = ((Array)type).of;
189)     w = new Constant(type.width);
190)     t1 = new Arith(new Token0*), i, w);
191)     loc = t1;
192)     while( look.tag == '[' ){ // multi-dimensional I -> [ E ] I
193)         match(''); i = bool0; match('');
194)         type = ((Array)type).of;
195)         w = new Constant(type.width);
196)         t1 = new Arith(new Token0*), i, w);
197)         t2 = new Arith(new Token('+'), loc, t1);
198)         loc = t2;
199)     }
200)     return new Access(a, loc, type);
201) }
202) }

```

## A.9 Creating the Front End

The code for the packages appears in five directories: **main**, **lexer**, **symbol**, **parser**, and **inter**. The commands for creating the compiler vary from system to system. The following are from a UNIX implementation:

```

javac lexer/*.Java
javac symbols/*.Java
javac inter/*.Java
javac parser/*.Java
javac main/*.Java

```

The **javac** command creates **.class** files for each class. The translator can then be exercised by typing **java main.Main** followed by the source program to be translated; e.g., the contents of file **test**

```

1) { // File test
2)   int i; int j; float v; float x; float[100] a;
3)   while( true ) {
4)     do i = i+1; while( a[i] < v );
5)     do j = j-1; while( a[j] > v );
6)     if( i >= j ) break;
7)     x = a[i]; a[i] = a[j]; a[j] = x;
8)   }
9) }

```

On this input, the front end produces

A.9. CREATING THE FRONT END

```
1) L1:L3: i = i + 1
2) L5:   t1 = i * 8
3)      t2 = a [ t1 ]
4)      if t2 < v goto
5) L4:   j = j - 1
6) L7:   t3 = j * 8
7)      t4 = a [ t3 ]
8)      if t4 > v goto
9) L6:   iffalse i >= j
10) L9:  goto L2
11) L8:  t5 = i * 8
12)     x = a [ t5 ]
13) L10: t6 = i * 8
14)     t7 = j * 8
15)     t8 = a [ t7 ]
16)     a [ t6 ] = t8
17) L11: t9 = j * 8
18)     a [ t9 ] = x
19)     goto LI
20) L2:
```

Try it.



## Appendix B

# Finding Linearly Independent Solutions

Algorithm B.I: Finds a maximal set of linearly independent solutions for  $Ax > 0$ , and expresses them as rows of matrix  $B$ .

**INPUT:** An  $m \times n$  matrix  $A$ .

**OUTPUT:** A matrix  $B$  of linearly independent solutions to  $Ax > 0$ .

**METHOD:** The algorithm is shown in pseudocode below. Note that  $X[y]$  denotes the  $y$ th. row of matrix  $X$ ,  $X[y : z]$  denotes rows  $y$  through  $z$  of matrix  $X$ , and  $X[y : z][u : v]$  denotes the rectangle of matrix  $X$  in rows  $y$  through  $z$  and columns  $u$  through  $v$ . •

```

M = A';
ro = 1;
Co = 1;
B = Inxn', /* an n-by-n identity matrix */

while ( true ) {

    /* 1. Make M[r0 : r' - 1][c0 : d - 1] into a diagonal matrix with
       positive diagonal entries and M[r' : n][c0 : m] = 0.
       M[r' : n] are solutions. */
    r' = r0;
    c = c0;
    while ( there exists M[r][c] ^ 0 such that
            r - r' and c - d are both > 0 ) {
        Move pivot M[r][c] to M[r'][c'] by row and column
        interchange;
        Interchange row r with row r' in B;
        if ( M[r'][d] < 0 ) {
            M[r'] = -1 * M[r'];
            B[r'] = -1 * B[r'];
        }
        for ( row; = ro to n ) {
            if ( row / r' and Mjrowjfc' / 0 {
                u = -{M[row][d]/M[r'][d]};
                M[row] = M[row] + u * M[r'];
                B[row] = B[row] + u * B[r'];
            }
        }
    }
}

```

```

/* 2. Find a solution besides  $M[r' : n]$ . It must be a
    nonnegative combination of  $M[r_0 : r' - 1][CQ : m]$  */
Find  $k_0, \dots, A_{v-i} > 0$  such that
     $A_{v_0}M[r_0][c' : m] + \dots + A_{v-i}M[r' - 1][c' : m] > 0;$ 
if (there exists a nontrivial solution, say  $A_i > 0$ ) {
     $M[r] = k_0M[r_0] + \dots + A_{v-i}M[r' - 1];$ 
    NoMoreSoln = false;
} else /*  $M[r' : n]$  are the only solutions */
    NoMoreSoln = true;

/* 3. Make  $M[r_0 : r_n - 1][c_0 : m] > 0$  */
if ( NoMoreSoln ) { /* Move solutions  $M[r' : n]$  to  $M[r_0 : r_n]$ 
    for (  $r = r'$  to  $n$  )
        Interchange rows  $r$  and  $r_0 + r - r'$  in  $M$  and  $B$ ;
         $r_n = r_0 + n - r' + 1;$ 
    else { /* Use row addition to find more solutions */
         $r_n = n + 1;$ 
        for (  $col = c'$  to  $m$  )
            if ( there exists  $M[ro][co]$   $< 0$  such that  $row > ro$ 
                if ( there exists  $M[r][coZ] > 0$  such that  $r > ro$  )
                    for (  $row = ro$  to  $r_n - 1$  )
                        if (  $M[ro][col] < 0$  ) {
                             $u = \lfloor -M[ro][col]/M[r][coV] \rfloor$ 
                             $M[ro] = M[ro] + u * M[r];$ 
                             $B[ro] = B[ro] + u * B[r];$ 
                        }
                    else
                        for (  $row = r_n - 1$  to  $ro$  step  $-1$  )
                            if (  $M[ro][col] < 0$  {
                                Interchange  $M[ro]$  with  $M[r_n];$ 
                                Interchange  $B[ro]$  with  $B[r_n];$ 
                            }
                        }
                }
            }
        }
    }

/* 4. Make  $M[r_0 : r_n - 1][1 : c_0 - 1] > 0$  */
for (  $row = ro$  to  $r_n - 1$  )
    for (  $col = 1$  to  $c_0 - 1$  )
        if (  $M[ro][col] < 0$  {
            Pick an  $r$  such that  $M[r][coZ] > 0$  and  $r < ro$ ;
             $u = \lfloor -M[ro][col]/M[r][coZ] \rfloor;$ 
             $M[ro] = M[ro] + u * M[r];$ 
             $B[ro] = B[ro] + u * B[r];$ 
        }
    }
}

```

APPENDIX B. FINDING LINEARLY INDEPENDENT SOLUTIONS

```
/* 5. If necessary, repeat with rows  $M[r_n : n]$  */
if ( (NoMoreSoln or  $r_n > n$  or  $r_n == ro$ ) {
    Remove rows  $r_n$  to  $n$  from  $B$ ;
    return  $B$ ;
}
else {
     $c_n = m + 1$ ;
    for (  $col = m$  to 1 step -1 )
        if ( there is no  $M[r][col] > 0$  such that  $r < r_n$  {
             $c_n = c_n - 1$ ;
            Interchange column  $col$  with  $c_n$  in  $M$ ;
        }
    }
```

# Index

## A

- Abstract syntax tree
  - See Syntax tree
- Abu-Sufah, W. 900
- Acceptance 149
- Accepting state
  - See Pinal state
- Access link 434, 445-449
- Action 58-59, 249, 327
- Activation record 433-452
- Activation tree 430-433
- Actual parameter 33, 434, 942
- Acyclic call string 910
- Acyclic path 667
- Acyclic test 821-822
- Ada 391
- Address 364, 374
- Address descriptor 543, 545-547
- Address space 427
- Advancing edge 661
- Affine array access 781, 801-804, 815-826
- Affine expression 687, 770
- Affine partitioning 781
- Affine space partition 830-838
- Affine transformation 778-782, 846-851
- Aho, A. V. 189-190, 301, 579-580
- Aho-Corasick algorithm 138-140
- Algebraic identities 536, 552
- Alias 35, 713, 903, 917, 933
- Alignment 374, 428
- Allen, F. E. 704, 899-900, 962
- Allen, R. 900
- Allocation, of memory 453
- Alpha 703
- Alphabet 117
- Ambiguous grammar 47, 203-204, 210-212, 255, 278-283, 291-294
- Amdahl's law 774
- Analysis 4
- Ancestor 46
- Andersen, L. 962
- Annotated parse tree 54
- Anticipated expression 645-648, 653
- Antidependence 711, 816
- Antisymmetry 619
- Antlr 300, 302
- Architecture 19-22
- Arithmetic expression 49-50, 68-69, 378-381, 971-974
- Array 373-375, 381-384, 537-539, 541, 584, 712-713, 770, 920
  - See also Affine array access
- Array contraction 884-887
- ASCII 117
- Assembler 3
- Assembly language 13, 508
- Associativity 48, 122, 279-281, 293, 619
- Atom 921
- Attribute 54, 112
  - See also Inherited attribute, Main attribute, Synthesized attribute
- Attribute grammar 306
- Augmented grammar 243
- Auslander, M. A. 580
- Auto-increment 739
- Automaton 147



- See also Deterministic finite automaton, LR(0) automaton, Nondeterministic finite automaton
- Available expression 610-615, 648-649, 653
- Avots, D. 962-963
- B**
- Back edge 662, 664-665
- Back end 4, 357
- Backpatching 410-417
- Backus, J. W. 300-301
- Backus-Naur form  
See BNF
- Backward flow 610, 615, 618, 627, 669
- Baker, H. G. Jr. 502
- Baker's algorithm 475-476, 482
- Ball, T. 962
- Banerjee, U. 900
- Banning, J. P. 962
- Barth, J. M. 962
- Base address 381
- Base register 762
- Basic block 525-541, 597, 600-601, 721-726
- Basic type 371
- Bauer, F. L. 354-355
- BDD 951-958
- Bddbddb 961
- Bergin, T. J. 38
- Berndl, M. 961-962
- Bernstein, D. 766-767
- Best-fit 458
- Big-oh 159
- Binary alphabet 117
- Binary decision diagram  
See BDD
- Binary translation 22
- Binning, of chunks 458
- Birman, A. 301
- Bison 300
- Block 29, 86-87, 95  
See also Basic block
- Block structure  
See Static scope
- Blocking 770-771, 785-787, 877-880, 888
- BNF  
See Context-free grammar
- Body 43, 197, 923
- Body region 673
- Boolean expression 399-400, 403-409, 411-413, 974-977
- Bottom element 619, 622
- Bottom-up parser 233-240  
See also LR parser, Shift-reduce parser
- Boundary condition 615
- Boundary tag 459
- Bounds checking 19, 24, 920-921
- Bounimova, E. 962
- Branch  
See Jump
- Branch-and-bound 824-825
- Break-statement 416-417
- Brooker, R. A. 354
- Bryant, R. E. 961-962
- Buffer 115-117
- Buffer overflow 918, 920-921
- Burke, M. 900
- Bus 772-773
- Bush, W. R. 962-963
- Bytecode 2
- C**
- C 13, 18, 25, 28-29, 381, 498, 903, 934
- Cache 20, 454-455, 457, 772, 783-785
- Cache interference 788
- Cadar, C. 963
- Call 365, 423-424, 467, 518-522, 539, 541
- Call graph 904-906, 943-944
- Call site 904, 950
- Call string 908-910, 946-949
- Callahan, D. 961, 963
- Call-by-name 35

- Call-by-reference 34
- Call-by-value 34
- Calling sequence 436-438
- Canonical derivation
  - See Rightmost derivation
- Canonical LR parser 259, 265-266, 283
- Canonical LR(1) set of items 260-264
- Canonical LR(0) set of items 243, 247
- Cantor, D. C. 300-301
- Carbin, M. 963
- Case sensitivity 125
- CFG
  - See Grammar
- Chaitin, G. J. 580
- Chandra, A. K. 580
- Character class 123, 126
- Charles, P. 900
- Chelf, B. 963
- Chen, S. 766-767, 899, 901
- Cheney, C. J. 502-503
- Cheney's algorithm 479-482
- Cheong, G. I. 901
- Child 46
- Chomsky, N. 300-301
- Chomsky Normal Form 232, 300
- Chou, A. 963
- Chow, F. 579-580
- Chunk 457-459
- Church, A. 502-503
- Circular dependency 307
- CISC 21, 507-508
- Class 33, 376
- Class variable 25-26
- Clock 708
- Cloning 910-911
- Closure 119, 121-122, 243-245, 261-262
  - See also Positive closure
- Closure, of transfer functions 679
- Coalescing, of chunks 459-460
- Cocke, J. 301, 579-580, 704, 900
- Cocke-Younger-Kasami algorithm 232, 301
- Code generation 10-11, 505-581, 707-767
  - See also Scheduling
- Code motion 592
  - See also Downward code motion, Loop-invariant expression, Partial redundancy elimination, Upward code motion
- Code optimization 5, 10, 15-19, 368, 583-705, 769-963
- Code scheduling
  - See Scheduling
- Coercion 99, 388-389
- Coffman, E. G. 900-901
- Coherent cache protocol 772-773
- Collins, G. E. 503
- Coloring 556-557
- Column-major order 382, 785
- Comment 77
- Common subexpression 533-535, 588-590, 611, 639-641
- Communication 828, 881-882, 894
- Commutativity 122, 619
- Compile time 25
- Complex instruction-set computer
  - See CISC
- Composition 624, 678, 693
- Computer architecture
  - See Architecture
- Concatenation 119, 121-122
- Concurrent garbage collection 495-497
- Conditional jump 513, 527
- Configuration 249
- Conflict 144, 565
  - See also Reduce-reduce conflict, Shift-reduce conflict
- Conservative data-flow analysis 603
- Constant 78-79
- Constant folding 536, 632-637
- Constant propagation
  - See Constant folding

- Constraint
    - See Control-dependence constraint, Data dependence, Resource constraint
  - Context sensitivity 906-908, 945-951
  - Context-free grammar
    - See Grammar
  - Context-free language 200, 215-216
  - Context-sensitive analysis 906-907, 945-950
  - Contiguous evaluation 574
  - Continue-statement 416-417
  - Control equivalence 728
  - Control flow 399-409, 413-417, 525
  - Control link 434
  - Control-dependence constraint 710, 716-717
  - Control-flow equation 600, 605
  - Convex polyhedron 789-790, 795-796
  - Cook, B. 962
  - Cooper, K. D. 580, 963
  - Copy propagation 590-591
  - Copy statement 544, 937
  - Copying garbage collector 478-482, 488, 497-498
  - Corasick, M. J. 189-190
  - Cousot, R. 704
  - Cousot, R. 704
  - C++ 13, 18, 34, 498
  - Critical cycle 758
  - Critical edge 643
  - Critical path 725
  - Cross edge 662
  - CUP 300, 302
  - Cutset 645
  - Cyclic garbage 488
  - CYK algorithm
    - See Cocke-Younger-Kasami algorithm
  - Cytron, R. 704, 900
- D**
- DAG 359-362, 533-541, 951
  - Dain, J. 300-301
  - Dalton, M. 962
  - Dangling else 210-212, 281-283
  - Dangling pointer 461
  - Dantzig, G. 900
  - Das, M. 961, 963
  - Data abstraction 18
  - Data dependence 711-715, 732, 747-749, 771, 781-782, 804-805, 815-826
    - See also Antidependence, Output dependence, True dependence
  - Data locality 891-892
    - See also Locality
  - Data reuse 804-815, 887-888
  - Data space 779-780
  - Data-dependence graph 722-723
  - Data-flow analysis 18, 23, 597-705, 921
  - Data-flow analysis framework 618
  - Datalog 921-933
  - Datalog program 923
  - Davidson, E. S. 767
  - Dead code 533, 535, 550, 591-592
  - Dead state 172, 183
  - Dead variable 608
  - Deallocation, of memory 453, 460-463
  - Declaration 32, 373, 376
  - Declarative language 13
  - Decode 708
  - Def 609
  - Definition 32
  - Definition, of a variable 601
  - Dependency graph 310-312
  - Depth, of a flow graph 665
  - Depth-first order 660
  - Depth-first search 57
  - Depth-first spanning tree 660
  - Dereferencing 461
  - DeRemer, F. 300-301
  - Derivation 44-46, 199-202
    - See also Leftmost derivation, Rightmost derivation
  - Descendant 46

- Deterministic finite automaton 149-156, 164-166, 170-186, 206
  - DFA
    - See Deterministic finite automaton
  - Dijkstra, E. W. 502-503
  - Diophantine equation 818-820
  - Directed acyclic graph
    - See DAG
  - Direct-mapped cache 457, 788
  - Display 449-451
  - Distributive framework 625, 635-636
  - Distributivity 122
  - Do-across loop 743-745
  - Do-all loop 738
  - Domain, of a data-flow analysis 599, 615
  - Domain, of a relation 954
  - Dominator 656-659, 672, 728
  - Dominator tree 657
  - Donnelly, C. 301
  - Downward code motion 731-732
  - Dumitran, D. 963
  - Dynamic access 816
  - Dynamic loading 944
  - Dynamic policy 25
  - Dynamic programming 573-577
    - See also Cocke-Younger-Kasami algorithm
  - Dynamic RAM 456
  - Dynamic scheduler 719, 737
  - Dynamic scope 31-33
  - Dynamic storage 429
    - See also Heap, Run-time stack
- E**
- Earley, J. 301
  - Earliest expression 649-650, 654
  - Eaves, B. C. 900
  - EDB
    - See Extensional database predicate
  - Edge
    - See Advancing edge, Back edge, Critical edge, Cross edge, Retreating edge
  - Emami, M. 961, 963
  - Empty string 44, 118, 121
  - Engler, D. 963
  - Entry node 531, 605
  - Environment 26-28
  - Epilog 742
  - €
    - See Empty string
  - e-free grammar 232
  - e-production 63, 65-66
  - Eqn 331
  - Equivalence-based analysis 935
  - Error correction 113-114, 192-196, 228-231
  - Error production 196
  - Error recovery 283-284, 295-297
  - Ershov, A. P. 426, 579-580, 705
  - Ershov number 567-572
  - Euclidean algorithm 820
  - Execution path 597, 628
  - Exit block 677
  - Exit node 605
  - Expression 94, 96-97, 101-105, 359, 568-572
    - See also Arithmetic expression, Boolean expression, Infix expression, Postfix expression, Prefix expression, Regular expression, Type expression
  - Extensional database predicate 924
- F**
- Fahndrich, M. 961, 963
  - Fall-through code 406
  - Farkas' lemma 872-875
  - Feautrier, P. 900
  - Feldman, S. I. 426
  - Fenichel, R. R. 502-503
  - Ferrante, J. 704, 900
  - Fetch 708
  - Field 377, 584, 935
  - Field load 937
  - Field store 937

- Fifth-generation language 13
  - Final state 130-131, 147, 205
  - Finite automaton
    - See Automaton
  - FIRST 220-222
  - First-fit 458
  - First-generation language 13
  - Firstpos 175-177
  - Fischer, C. N. 580
  - Fisher, J. A. 766-767
  - Fission 848, 850, 854
  - Fixedpoint
    - See Maximum fixedpoint
  - Flex 189-190
  - Floating garbage 484
  - Flow graph 529-531
    - See also Reducible flow graph, Super control-flow graph
  - Flow sensitivity 933, 936-937
  - Floyd, R. W. 300-301
  - FOLLOW 220-222
  - Followpos 177-179
  - Formal parameter 33, 942
  - Fortran 113, 382, 779, 886
  - Fortran H 703
  - Forward flow 615, 618, 627, 668
  - Fourier-Motzkin algorithm 796-797
  - Fourth-generation language 13
  - Fragmentation 457-460
  - Framework
    - See Data-flow analysis framework, Distributive framework, Monotone framework
  - Fraser, C. W. 580
  - Free chunk 457
  - Free list 459-460, 471
  - Free state 473
  - Frege, G. 502-503
  - Front end 4, 40-41, 357, 986
  - Frontier
    - See Yield
  - Full redundancy 645
  - Fully permutable loops 861, 864-867, 875-876
  - Fully ranked matrix 808
  - Function 29
    - See also Procedure
  - Function call
    - See Call
  - Function type 371, 423
  - Functional language 443
  - Fusion 848, 850
- G**
- Ganapathi, M. 579-580
  - Gao, G. 902
  - Garbage collection 25, 430, 463-499
    - See also Mark-and-compact, Mark-and-sweep, Short-pause garbage collection
  - GCD 818-820
  - Gear, C. W. 705
  - Gen 603, 611
  - Generational garbage collection 483, 488-489
  - Gen-kill form 603
  - Geschke, C. M. 705
  - Ghiya, R. 961, 963
  - Gibson, R. G. 38
  - Glaeser, C. D. 767
  - Glanville, R. S. 579-580
  - Global code optimization
    - See Code optimization
  - Global variable 442
  - GNU 38, 426
  - Gosling, J. 426
  - GOTO 246, 249, 261
  - Graham, S. L. 579-580
  - Grammar 42-50, 197-199, 204-205
    - See also Ambiguous grammar, Augmented grammar
  - Grammar symbol 199
  - Granularity 917
  - Granularity, of parallelism 773-775
  - Graph
    - See Call graph, DAG, Data-dependence graph, Dependency graph, Flow graph, Program-dependence graph
  - Graph coloring

See Coloring  
 Greatest common divisor  
   See GCD  
 Greatest lower bound 620, 622  
 Gross, T. R. 766-767  
 Ground atom 921  
 Group reuse 806, 811-813  
 Grune, D. 302  
 Gupta, A. 900-901

**H**

Hallem, S. 963  
 Halstead, M. H. 426  
 Handle 235-236  
 Hanson, D. R. 580  
 Hardware register renaming 714  
 Hardware synthesis 22  
 Head 42, 197, 923  
 Header 665, 672  
 Heap 428-430, 452-463, 518, 935  
 Hecht, M. S. 705  
 Height, of a semilattice 623, 626, 628  
 Heintze, N. 961, 963  
 Hendren, L. J. 961-963  
 Hennessy, J. L. 38, 579-580, 766-767, 899, 901  
 Hewitt, C. 502-503  
 Hierarchical reduction 761-762  
 Hierarchical time 857-859  
 Higher-order function 444  
 Hoare, C. A. R. 302  
 Hobbs, S. O. 705  
 Hole 457  
 Hopcroft, J. E. 189-190, 302  
 Hopkins, M. E. 580  
 Hudson, R. L. 502-503  
 Hudson, S. E. 302  
 Huffman, D. A. 189-190  
 Huskey, H. D. 426

**I**

IDB  
   See Intensional database predicate

Ideal solution, to a data-flow problem 628-630  
 Idempotence 122, 619  
 Identifier 28, 79-80  
 Identity function 624  
 If-statement 401  
 Immediate dominator 657-658  
 Imperative language 13  
 Inclusion-based analysis 935  
 Increment instruction 509  
 Incremental evaluation 928-930  
 Incremental garbage collection 483-487  
 Incremental translation  
   See On-the-fly generation  
 Independent variables test 820-821  
 Index 365  
 Indexed address 513  
 Indirect address 513  
 Indirect triples 368-369  
 Induction variable 592-596, 687-688  
 Infix expression 40, 52-53  
 Ingerman, P. Z. 302  
 Inheritance 18  
 Inherited attribute 55, 304-305, 307  
 Initial state  
   See Start state  
 Initialization 615  
 Initiation interval 745  
 Inlining 903-904, 914  
 Input buffering  
   See Buffer  
 Instruction pipeline 708-709  
   See also Software pipelining  
 Integer linear programming 817-825  
 Intensional database predicate 924  
 Interleaving 887-890  
 Intermediate code 9, 91-105, 357-426, 507, 971-981  
 Interpreter 2  
 Interprocedural analysis 713, 903-964  
 Interrupt 526  
 Intersection 612-613, 615, 620, 650  
 Intraprocedural analysis 903

Irons, E. T. 354  
 Item 242-243  
   See also Kernel item, Set of items,  
   Valid item  
 Iteration space 779-780, 788-799  
 Iterative data-flow algorithm 605-  
   607, 610, 614, 626-628

**J**

Jacobs, C. J. H. 302  
 Java 2, 13, 18-19, 25, 34, 76, 381,  
   903, 934, 944  
 Java virtual machine 507-508  
 Jazayeri, M. 354  
 JFlex 189-190  
 Johnson, R. K. 705  
 Johnson, S. C. 300-302, 355, 426,  
   502-503, 579-580  
 Join 621, 955  
 Jump 513, 527, 551-552  
 Jumping code 408, 974-977  
 Just-in-time compilation 508  
 JVM

  See Java virtual machine

**K**

Kam, J. B. 705  
 Kasami, T. 301-302, 705  
 Kennedy, K. 899-900, 963  
 Kernel 777  
 Kernel item 245, 272-273  
 Kernighan, B. W. 189-190  
 Keyword 50-51, 79-80, 132-133  
 Kill 601, 603, 611  
 Killdall, G. 704-705  
 Kleene closure  
   See Closure  
 Kleene, S. C. 189-190  
 Knoop, J. 705  
 Knuth, D. E. 189-190, 300, 302, 354-  
   355, 502-503  
 Knuth-Morris-Pratt algorithm 136-  
   138  
 Korenjak, A. J. 300, 302

Kosaraju, S. R. 705  
 Kuck, D. J. 766-767, 899-901  
 Kung, H. T. 901

**L**

Label 46, 364, 366  
 LALR parser 259, 266-275, 283, 287  
 Lam, M. S. 767, 899-902, 961-964  
 Lampert, L. 503, 766-767, 899-901  
 Language 44, 118  
   See also Java, Source language,  
   Target language  
 Lastpos 175-177  
 Latest expression 649, 654  
 Lattice 621  
   See also Semilattice  
 Lattice diagram 621-622  
 L-attributed definition 313-314, 331-  
   352  
 Law  
   See Associativity, Commutativ-  
   ity, Distributivity, Idempot-  
   ence  
 Lawrie, D. H. 900  
 Lazy code motion  
   See Partial redundancy elimi-  
   nation  
 Lea 458  
 Leader 526-527  
 Leaf 45-46  
 Leaf region 673  
 Least upper bound 621  
 LeBlanc, R. J. 580  
 Left side  
   See Head  
 Left-associativity 48  
 Left-factoring 214-215  
 Leftmost derivation 201  
 Left-recursion 67-68, 71, 212-214,  
   328-331  
 Left-sentential form 201  
 Leiserson, C. E. 901  
 Lesk, M. E. 189-190  
 Leu, T. 963  
 Levin, V. 962

- Lewis, P. M. II 300, 302, 355
  - Lex 126-127, 140-145, 166-167, 189-190, 294-295
  - Lexeme 111
  - Lexical analyzer 5-7, 41, 76-84, 86, 109-190, 209-210, 294-295, 967-969
  - Lexical error 194
  - Lexical scope
    - See Static scope
  - Lexicographic order 791
  - Liao, S.-W. 901
  - Lichtenber, J. 962
  - Lieberman, H. 502-503
  - Lim, A. W. 901
  - Linear programming
    - See Integer linear programming
  - List scheduling 723-726
  - Literal 922
  - Live variable 528-529, 608-610, 615
  - Livshits, V. B. 962-963
  - LL grammar 223
  - LL parser
    - See Predictive parser
  - LLgen 300
  - Load instruction 512
  - Loader 3
  - Local code optimization
    - See Basic block
  - Locality 455, 769
    - See also Spatial locality, Temporal locality
  - Location 26-28
  - Logical address 427
  - Logical error 194
  - Lohtak, O. 962
  - Lookahead 78, 144-145, 171-172, 272-275
  - Lookahead-LR parser
    - See LALR parser
  - Loop 531, 554, 556, 655-656, 775
    - See also Do-all loop, Fully permutable loops, Natural loop
  - Loop fission
    - See Fission
  - Loop fusion
    - See Fusion
  - Loop nest 780, 791, 797, 862
  - Loop region 674
  - Loop reversal
    - See Reversal
  - Loop unrolling 735, 740-741, 743
  - Loop-invariant expression 641-642
  - Loop-residue test 822-823
  - Loveman, D. B. 901
  - Lowry, E. S. 579-580, 705
  - LR(0) automaton 243, 247-248, 252
  - LR parser 53-252, 275-277, 325, 348-352
    - See also Canonical LR parser, LALR parser, SLR parser
  - L-value 26, 98
    - See also Location
- ## M
- Machine language 508
  - Macro 13
  - Main attribute 341
  - Mark-and-compact 476-482
  - Mark-and-sweep 471-476, 482
  - Marker nonterminal 349
  - Markstein, P. W. 580
  - Martin, A. J. 503
  - Martin, M. C. 963
  - Matrix multiplication 782-788
  - Maximum fixedpoint 626-628, 630-631
  - Maydan, D. E. 899, 901
  - McArthur, R. 426
  - McCarthy, J. 189-190, 502-503
  - McClure, R. M. 302
  - McCullough, W. S. 189-190
  - McGarvey, C. 962
  - McKellar, A. C. 900-901
  - McNaughton, R. 189-190
  - McNaughton-Yamada-Thompson algorithm 159-161
  - Medlock, C. W. 579-580, 705
  - Meet 605, 615, 618-619, 622-623, 633, 678, 695



Meet-over-paths solution 629-631  
 Memoization 823  
 Memory 20, 772-773  
   See also Heap, Physical memory, Storage, Virtual memory  
 Memory hierarchy 20, 454-455  
 Memory leak 25, 461  
 Message-passing machine 773, 894  
 META 300  
 Metal 918, 962  
 Method 29  
   See also Procedure, Virtual method  
 Method call  
   See Call  
 Method invocation 33  
 MGU  
   See Most general unifier  
 Milanova, A. 962-963  
 Milner, R. 426  
 Minimization, of states 180-185  
 Minsky, M. 503  
 ML 387, 443-445  
 Mock, G. 426  
 Modular resource-reservation table  
   746-747, 758  
 Modular variable expansion 758-761  
 Monotone framework 624-628, 635  
 Moore, E. F. 189-190  
 MOP  
   See Meet-over-paths solution  
 Morel, E. 705  
 Morris, D. 354  
 Morris, J. H. 189-190  
 Moss, J. E. B. 502-503  
 Most general unifier 393  
   See also Unification  
 Motwani, R. 189-190, 302  
 Mowry, T. C. 900-901  
 Multiprocessor 772-773, 895  
   See also SIMD, Single-program  
   multiple data  
 Muraoka, Y. 766-767, 899, 901  
 Mutator 464

**N**

NAA 690  
 NAC 633  
 Name 26-28  
 Narrowing 388-389  
 Natural loop 667, 673  
 Naur, P. 300, 302  
 Neighborhood compaction 736  
 Neliac 425  
 Nested procedure declarations 442-  
   445  
 Next-fit 458-459  
 NFA  
   See Nondeterministic finite au-  
   tomaton  
 Node 46  
 Node merging 953  
 Nondeterministic finite automaton  
   147-148, 152-175, 205, 257  
 Nonreducible flow graph  
   See Reducible flow graph  
 Nonterminal 42-43, 45, 197-198  
   See also Marker nonterminal  
 Nonuniform memory access 773  
 Null space 808-809  
 Nullable 175-177  
 Nullity 808  
 NUMA  
   See Nonuniform memory access

**O**

Object code 358  
   See also Code generation  
 Object creation 937  
 Object ownership 462  
 Object program 427-428  
 Object sensitivity 950  
 Object-oriented language  
   See C++, Java  
 Offset 377-378  
 Ogden, W. F. 354  
 Olsztyn, J. 426  
 Ondrusek, B. 962

- On-the-fly generation 340-343, 380-381
- Optimization
  - See Code optimization
- Ordered BDD 952
- Output dependence 711, 816
- Overloading 99, 390-391
  
- P**
- Paakki, J. 354-355
- Padua, D. A. 902
- Panic-mode garbage collection 492-493
- Panic-mode recovery 195-196, 228-230, 283-284
- Panini 300
- Parafraze 899
- Parallel garbage collection 495-497
- Parallelism 19-20, 707-902, 917
- Parameter 422
  - See also Actual parameter, Formal parameter, Procedure parameter
- Parameter passing 33-35, 365
- Parametric polymorphism 391
  - See also Polymorphism
- Parent 46
- Parr, T. 302
- Parse tree 45-48, 201-204
  - See also Annotated parse tree
- Parser 8, 41, 45, 60-61, 110-111, 191-302, 981-986
  - See also Bottom-up parser, Top-down parser
- Parser generator
  - See Antlr, Bison, CUP, LLgen, Yacc
- Parser state 241-242
  - See also Set of items
- Partial garbage collection 483, 487-494
- Partial order 619-621, 623
- Partial redundancy elimination 639-655
- Partially dead variable 655
- Partially ordered set
  - See Poset
- Pass 11
- Patel, J. H. 767
- Path
  - See Acyclic path, Critical path, Execution path, Meet-over-paths solution, Weight, of a path
- Pattern 111
- Pattern matching, of trees 563-567
- Patterson, D. A. 38, 579-580, 766-767, 899, 901
- Pause time 465
  - See also Short-pause garbage collection
- P-code 386
- PDG
  - See Program-dependence graph
- Peepphole optimization 549-552
- Pelegri-Llopart, E. 580
- Permutation 849-850
- Peterson, W. W. 705
- PFC 899
- Phase 11
- Phoenix 38
- Phrase-level recovery 196, 231
- Physical address 427
- Physical memory 454-455
- Pierce, B. C. 426
- Pincus, J. D. 962-963
- Pipeline
  - See Instruction pipeline, Pipelining, Software pipelining
- Pipelining 861-884
- Pitts, W. 189-190
- Pnueli, A. 964
- Pointer 365, 373, 514, 539, 935
  - See also Dangling pointer, Stack pointer
- Pointer analysis 713, 903, 917, 933-951
- Poison bit 718
- Polyhedron
  - See Convex polyhedron

- Polymorphism 391-395
  - Porterfield, A. 900, 902
  - Poset 619
  - Positive closure 123
  - Postdominator 728
  - Postfix expression 40, 53-54
  - Postfix translation scheme 324-327
  - Postorder traversal 58, 432
    - See also Depth-first order
  - Postponable expression 646, 649, 651-654
  - Power set 620
  - Pratt, V. R. 189-190
  - PRE
    - See Partial redundancy elimination
  - Precedence 48, 121-122, 279-281, 293-294
  - Predecessor 529
  - Predicate 921-922
  - Predicated execution 718, 761
  - Predictive parser 64-68, 222-231, 343-348
  - Prefetch 457
  - Prefetching 718, 896
  - Prefix 119, 918, 962
  - Prefix expression 327
  - Preorder traversal 58, 432
  - Preprocessor 3
  - Prioritized topological order 725-726
  - Private 31
  - Privatizable variable 758
  - Procedure 29, 422-424
  - Procedure call
    - See Call
  - Procedure parameter 448-449
  - Processor space 779-781, 838-841
  - Product lattice 622-623
  - Production 42-43, 45, 197, 199
    - See also Error production
  - Proebsting, T. A. 580
  - Program-dependence graph 854-857
  - Programming language 12-14, 25-35
    - See also Ada, C, C++, Fortran, Java, ML
  - Projection 955
  - Prolog 742
  - Prosser, R. T. 705
  - Protected 31
  - Pseudoregister 713
  - PTRAN 900
  - Public 31
  - Pugh, W. 899, 902
  - Purify 25, 462
- Q**
- Qian, F. 962
  - Quadruple 366-368
  - Quicksort 431-432, 585
- R**
- Rabin, M. O. 189-190
  - Rajamani, S. K. 962
  - Randell, B. 502-503
  - Rank, of a matrix 807-809
  - Rau, B. R. 767
  - Reaching definitions 601-608, 615
  - Read barrier 486
  - Record 371, 376-378, 584
  - Recursive descent 338-343
  - Recursive type 372
  - Recursive-descent parser 64, 219-222
  - Reduced instruction-set computer
    - See RISC
  - Reduce-reduce conflict 238-240, 293
  - Reducible flow graph 662, 664, 673-677, 684-685
  - Reduction 234, 324
  - Reduction in strength 536, 552, 592-596
  - Reference
    - See Pointer
  - Reference count 462-463, 466, 468-470
  - Reference variable 34, 686-689
  - Reflection 944-945
  - Reflexivity 619

- Region 672-686, 694-699, 733-734, 911
  - Region-based allocation 463
  - Register 18, 20, 454-455, 542-543, 714-715
    - See also Pseudoregister, Rotating register file
  - Register allocation 510-512, 553-557, 570-572, 716, 743
  - Register assignment 510, 556
  - Register descriptor 543, 545-547
  - Register pair 510
  - Register renaming
    - See Hardware register renaming
  - Regular definition 123
  - Regular expression 116-122, 159-163, 179-180, 189, 210
  - Rehof, J. 961, 963
  - Re-indexing 848, 850
  - Relation 922, 954
  - Relative address 371, 373, 381
  - Remembered set 491
  - Renvoise, C. 705
  - Reserved word
    - See Keyword
  - Resource constraint 711
  - Resource-reservation table 719-720
    - See also Modular resource-reservation table
  - Retreating edge 661, 664-665
  - Return 365, 467, 518-522, 906, 942
  - Return value 434
  - Reuse
    - See Data reuse
  - Reversal 849-850
  - Right side
    - See Body
  - Right-associativity 48
  - Rightmost derivation 201
  - Right-sentential form 201, 256
  - Rinard, M. 962-963
  - RISC 21, 507-508
  - Ritchie, D. M. 426, 502-503
  - Rodeh, M. 766-767
  - Root 46
  - Root set 466-467, 488
  - Rosen, B. K. 704
  - Rosenkrantz, D. J. 355
  - Rotating register file 762
  - Rothberg, E. E. 900-901
  - Rounds, W. C. 354
  - Rountev, A. 962-963
  - Row
    - See Tuple
  - Row-major order 382, 785
  - Roy, D. 963
  - Rule 922-923
  - Run time 25
  - Run-time environment 427
  - Run-time stack 428-451, 468
  - Russell, L. J. 502-503
  - Ruwase, O. 962-963
  - R-value 26, 98
  - Ryder, B. G. 962-963
- S**
- Sadgupta, S. 767
  - Safety
    - See Conservative data-flow analysis
  - Samelson, K. 354-355
  - Sarkar, V. 902
  - S-attributed definition 306, 312-313, 324
  - Scaling 848, 850
  - Scanned state 474
  - Scanning 110
    - See also Lexical analyzer
  - SCC
    - See Strongly connected component
  - Scheduling 710-711, 716
  - Scholten, C. S. 503
  - Schorre, D. V. 302
  - Schwartz, J. T. 579, 581, 704
  - Scope 86
  - Scott, D. 189-190
  - Scott, M. L. 38
  - Scripting language 13-14

- SDD
  - See Syntax-directed definition
- SDT
  - See Syntax-directed translation
- SDV 962
- Secondary storage 20
- Second-generation language 13
- Sedgewick, R. 585
- Self reuse 806-811
- Semantic analysis 8-9
- Semantic error 194
- Semantic rule
  - See Syntax-directed definition
- Semantics 40
- Semilattice 618-623
- Sensitivity
  - See Context sensitivity, Flow sensitivity
- Sentence 200
- Sentential form 200
  - See also Left-sentential form, Right-sentential form
- Sentinel 116
- Set associativity 457
- Set of items 243-246, 257
  - See also Canonical LR(0) set of items, Canonical LR(1) set of items
- Sethi, R. 38, 579, 581
- Shannon, C. 189-190
- Sharir, M. 964
- Shift-reduce conflict 238-240, 293
- Shift-reduce parser 236-240
- Short-circuiting 953
- Short-pause garbage collection 483-494
- Shostak, R. 902
- Side effect 306, 314-316, 727
- Sielaff, D. J. 962-963
- Signature 361
- SIMD 21, 895-896
- Simple syntax-directed definition 56
- Simulation 23
- Single instruction, multiple data
  - See SIMD
- Single production 232
- Single-program multiple data 776
- Skewing 849-850
- SLAM 962
- SLR parser 252-257, 283
- SMP
  - See Symmetric multiprocessor
- Software pipelining 738-763, 895
- Software productivity 23-25
- Software vulnerability
  - See Vulnerability, of software
- SOR
  - See Successive over-relaxation
- Sound type system 387
- Source language 1
- Space
  - See Data space, Iteration space, Null space, Processor space
- Space-partition constraint 831-838
- Spatial locality 455-457, 465, 777, 884
- Spatial reuse 806, 809-811
- Speculative execution 708, 717-719
- Spilling, of registers 716
- SPMD
  - See Single-program multiple data
- SQL 22-23
- SQL injection 918-919
- SSA
  - See Static single-assignment form
- Stable set 488
- Stack 325, 518, 520
  - See also Run-time stack
- Stack machine 507
- Stack pointer 437
- Stallman, R. 301
- Start state 131, 147, 205
- Start symbol 43, 45, 197
- State 147, 205
  - See also Dead state, Minimization, of states, Parser state
- State (of the program store) 26-28
- Statement 93-94, 100-101, 978-981
  - See also Break-statement, Continue-statement, If-statement, Switch-

- statement, While-statement
  - Static access 816
  - Static allocation 518, 524
  - Static checking 97-98, 357
    - See also Type checking
  - Static policy 25
  - Static RAM 456
  - Static scope 25, 28-31, 442
    - See also Scope
  - Static single-assignment form 369-370
  - Static storage 429, 442
  - Steady state 742
  - Stearns, R. E. 300, 302, 355
  - Steel, T. 426
  - Steensgaard, B. 961, 964
  - Steffens, E. F. M. 503
  - Storage
    - See Dynamic storage, Static storage
  - Storage layout 373
  - Storage-related dependence
    - See Antidependence, Output dependence
  - Store instruction 512
  - Stratified Datalog program 930-931
  - Strength reduction
    - See Reduction in strength
  - String 118-119, 373
  - Strong, J. 426
  - Strongly connected component 751, 859
  - Strongly typed language 387
  - Structure
    - See Class, Record
  - Subgoal 923
  - Subsequence 119
  - Subset construction 153-154
  - Substring 119
  - Successive over-relaxation 863
  - Successor 529
  - Suffix 119
  - Summary-based analysis 911-914
  - Super control-flow graph 906
  - Superscalar machine 710
  - Switch-statement 418-421
  - Symbol table 4-5, 11, 85-91, 423, 970-971
  - Symbolic analysis 686-699
  - Symbolic constant 793
  - Symbolic map 690
  - Symmetric multiprocessor 772
  - Synchronization 828, 832, 853-854, 880-882
  - Syntax 40
    - See also Grammar
  - Syntax analysis
    - See Parser
  - Syntax error 194
  - Syntax tree 41, 69-70, 92-93, 318-321, 358, 367, 981-986
  - Syntax-directed definition 54-56, 304-316
  - Syntax-directed translation 40, 57-60, 324-352
  - Synthesis 4
  - Synthesized attribute 54-56, 304-305
- T
- Table
    - See Relation, Resource-reservation table, Symbol table, Transition table
  - Tail recursion 73
  - Takizuka, T. 767
  - Tamura, E. 767
  - Tardieu, O. 961, 963
  - Target code
    - See Object code
  - Target language 1
  - Target set 488
  - Task parallelism 776
  - Temporal locality 455-457, 777, 884-885
  - Temporal reuse 806
  - Terminal 42-43, 45, 197-198, 305
  - TeX 331
  - Third-generation language 13
  - Thompson, K. 189-190

- Three-address code 42, 99, 363-369
  - Tick
    - See Clock
  - Tiling 560-563
  - Time-partition constraint 868-875, 989-992
  - Tjiang, S. W. K. 579-580
  - TMG 300
  - Token 41, 43, 76, 111
  - Tokura, N. 705
  - Tokuro, M. 767
  - Top element 619, 622
  - Top-down parser 61-68, 217-233
    - See also Predictive parser, Recursive-descent parser
  - Topological order 312
    - See also Prioritized topological order
  - Torczon, L. 580, 963
  - Towle, R. A. 902
  - Trace-based garbage collection 470-471
    - See also Mark-and-compact, Mark-and-sweep
  - Train algorithm 483, 490-493
  - Transfer barrier 486
  - Transfer function 599-600, 603-604, 615, 623-624, 629, 634, 676-679, 691-693
  - Transition 205
  - Transition diagram 130-131, 147-148
    - See also Automaton
  - Transition function 147, 150
  - Transition table 148-149, 185-186
  - Transitivity 619-620
  - Traversal 56-57
    - See also Depth-first search, Postorder traversal, Preorder traversal
  - Tree 46, 56
  - Tree rewriting 558-567
  - Triple 367-368
  - Tritter, A. 426
  - True dependence 711, 815
  - T1-T2 reduction 677
  - Tuple 954
  - Type 938
    - See also Basic type, Function type, Recursive type
  - Type checking 24, 98-99, 370, 386-398
  - Type Conversion 388-390
    - See also Coercion
  - Type equivalence 372-373
  - Type expression 371-372, 393, 395
  - Type inference 387, 391-395
  - Type safety 19, 464-465
  - Type synthesis 387
  - Type variable 391
- U**
- Ullman, J. D. 189-190, 301-302, 579, 581, 705, 962, 964
  - Umanee, N. 962
  - UNCOL 425
  - UNDEF 633
  - Unification 393, 395-398
  - Union 119, 121-122, 605, 613, 615, 620, 650, 955-957
  - Unkel, C. 963
  - Unreachable code
    - See Dead code
  - Unreached state 473
  - Unsafe Datalog rule 930
  - Unsafe language 498
  - Unscanned state 474
  - Upward code motion 730-732
  - Usage count 554-555
  - Use 609
  - Use before definition 602
  - Used expression 649, 653-654
  - Used variable 528-529
  - Ustuner, A. 962
- V**
- Valid item 256
  - Value 26-27
  - Value-number 360-362, 390

- Variable 26-28  
    See also Nonterminal, Reference variable
- Variable expansion  
    See Modular variable expansion
- Variable-length data 438-440
- Vector machine 886, 895-896.
- Very-busy expression  
    See Anticipated expression
- Very-long instruction word  
    See VLIW
- Viable prefix 256-257
- Virtual machine 2  
    See also Java virtual machine
- Virtual memory 454-455
- Virtual method 904, 916-917, 934, 941-944
- VLIW 19-21, 710
- Von Neumann language 13
- Vulnerability, of software 917-921
- Vyssotsky, V. 704-705
- W
- Wavefronting 876-877
- Weber, H. 300, 302
- Wegman, M. N. 704
- Wegner, R 704-705
- Wegstein, J. 426
- Weight, of a path 822
- Weinberger, R J. 189-190
- Weinstock, C. B. 705
- Wexelblat, R. L. 38
- Whaley, J. 961, 963-964
- While-statement 401
- White space 41, 77-78
- Widening 388-389
- Widom, J. 962, 964
- Width, of a type 374
- Wilderness chunk 458
- Wilson, R R. 502-503
- Wirth, N. 300, 302, 426
- Wolf, M. E. 900-902
- Wolfe, M. J. 902
- Wonnacott, D. 899, 902
- Wood, G. 767
- Write barrier 486-487
- Wulf, W. A. 705
- Y
- Yacc 287-297, 354
- Yamada, H. 189-190
- Yield 46-47, 201
- Yochelson, J. C. 502-503
- Younger, D. H. 301-302
- Z
- Zadeck, F. K. 704
- Zhu, J. 961, 964













**This new edition of the classic "Dragon" book** has been completely revised to include the most recent developments in compiling. The book provides a thorough introduction to compiler design and continues to emphasize the applicability of compiler technology to a broad range of problems in software design and development. The first half of the book is designed for use in an undergraduate compilers course, while the second half can be used in a graduate course stressing code optimization.

**New chapters include:**

*Chapter 7: Run-Time Environments*

*Chapter 10: Instruction-Level Parallelism*

*Chapter 11: Optimizing for Parallelism and locality*

*Chapter 12: Interprocedural Analysis*

O

**Pr** **Gradience** is a Web-based homework and lab assessment resource for students and instructors. **I** **For Compilers** it offers a collection of homework sets using a special technique called root questions. Students work through a problem as if it were a normal homework assignment. Their knowledge of the solution is then sampled by a randomly chosen multiple-choice question. When a wrong answer is selected, they receive a hint and immediate advice that explains why the answer is wrong or suggests a general approach to the problem. Students are then allowed to try the same assignment again. This approach provides immediate reinforcement of compiler concepts. Using Gradience allows instructors to assign, test, and track homework automatically and enhances their students' overall learning experience. A complimentary subscription is offered when an access code is ordered packaged with a new copy of this text. Subscriptions may also be purchased online, for more information about Gradience, please visit [aw.com/gradience](http://aw.com/gradience).

C/5



Ullman

Second  
Edition

PEARSON

Addison  
Wesley

Addison Wesley (oinpuling  
Leading Authors • Quality Products

Visit [aw.com/computing](http://aw.com/computing) for more  
information about Addison-Wesley  
computing books.

